

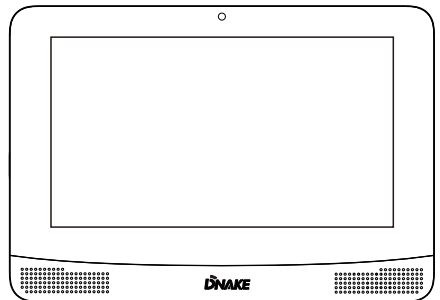

INDOOR
MONITOR

MODEL:

A416



USER MANUAL

REMARK

Please follow the user manual for correct installation and testing. If there is any doubt please call our tech-supporting and customer center.

Our company applies ourselves to reformation and innovation of our products. No extra notice for any change. The illustration shown here is only for reference. If there is any difference, please take the actual product as the standard.

The product and batteries must be handled separately from household waste. When the product reaches the end of service life and needs to be discarded, please contact the local administrative department and put it in the designated collection points in order to avoid the damage to the environment and human health caused by any disposal. We encourage recycling and reusing the material resources.

CATALOG

Product Features	1
Technical Parameters	1
Package Contents.....	2
Pictures.....	2
Operations	3
Web Settings	22
System Configuration	26
System Diagram.....	27
Installation	29
Troubleshooting	31
Safety Instructions.....	32

PRODUCT FEATURES

1. Building intercom application:

Talkback: Support video call, monitoring, unlocking, and checking of call records.

Security: Support 8 alarm zones with three states, zone and scene setup.

Smart: Support smart home extension by RS485 communication.

2. Operating system: Android.

TECHNICAL PARAMETERS

Voltage: DC 12V

PoE

Rated power: 10W

Standby power consumption: 3W

Display screen: 7-inch IPS LCD

Touch screen: Capacitive touch screen

Resolution: 1024x600

Working Temperature: -10°C to +55°C

Storage Temperature: -10°C to +60°C

Working Humidity: 10% to 90% (non-condensing)

PACKAGE CONTENTS

Please make sure the package contains the following items :

MODEL: A416

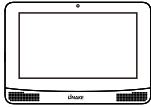

Indoor Monitor

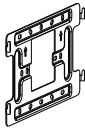

Bracket



Screw



Quick Start Guide

PICTURES

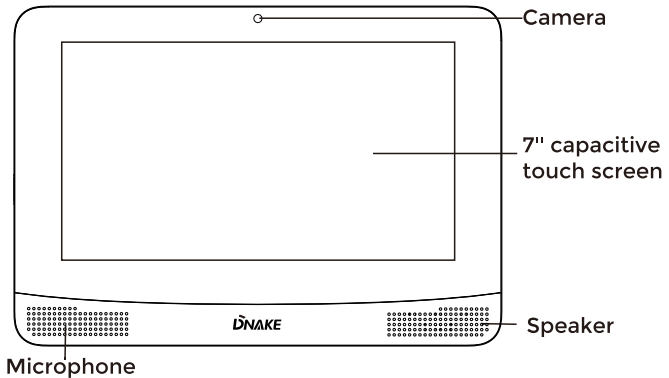

OPERATIONS

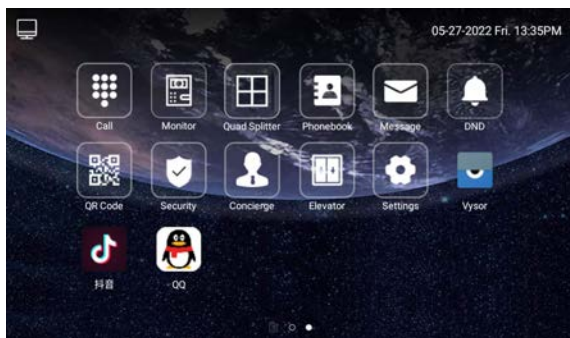

Main menu: Call, Monitor, Quad Splitter, Phonebook, Message, DND, QR Code, Security, Concierge, Elevator, Settings.

1.Call



Click "Call" icon on the main interface, the system will enter the following interface:



1.1 Call Logs

Click “Call Logs” icon, the system will enter the following interface:



 refers to call-out record;  refers to call-in record;  refers to missed call record. It can save up to 60 records.

Select one record and click  icon to call; click  icon to delete it.

If there is any snapshot image, click  icon to view it.

1.2 Dial

Click “Dial” icon, the system will enter the following interface:

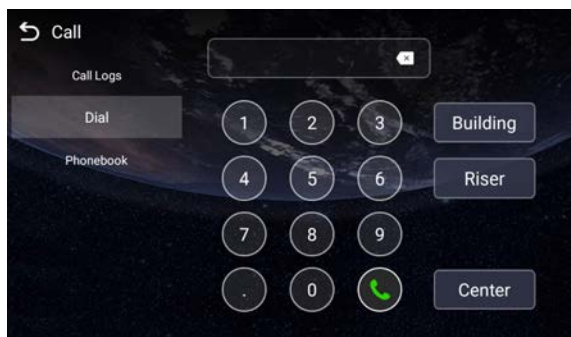

1.2.1 Call Resident

Input 1-3 digits building No.+ “Building” + 2-digit Unit No. + “Riser” +4-digit room No., then click  icon to call.

The system will enter into the following interface:





When the call is answered, the system will enter into call state:

1. If there is a camera, the caller's image will be displayed on the screen;
2. When the call is answered, the video will be uploaded into the indoor monitor.

When calling, the indoor monitor will ring; if there is no answer within 25 seconds, the call will be ended.

click  icon to end the call.

You can make audio and video recording during communication (TF card should be inserted into indoor monitor). Click  icon to take a snapshot; click  icon to save the video and image for current communication.

The system's default call duration is 120s.

1.2.2 Call Master Station

Click “  ” icon to call master station, the system will call master station No.1-No.5 successively. If the master station cannot be searched or call failed, the system will automatically call next master station. When the master station answers, it will ring and stop calling next one.



Click  icon to end the communication.

1.2.3 Receive Call from Door Station

When the door station, wall station or secondary door station calls, the indoor monitor will ring; when door station calls indoor monitor, the image from door station will be displayed on the indoor monitor; if there is no answer within 25 seconds, the call will be ended.

click  icon to end the call; click  icon to unlock the door.

Remark: Click  icon to switch between answering interface and monitoring interface of IP camera. After numeric keypad shows, press number key "2" to "9" to select the IP camera and press "1" to return to previous page.

You can make audio and video recording during communication (TF card should be inserted into indoor monitor). Click  icon to take a snapshot of the visitor; click  icon to save the video and image for current communication.

The system's default call duration is 120s.



1.3 Phonebook

Click "Phonebook" icon, the system will enter the following interface:





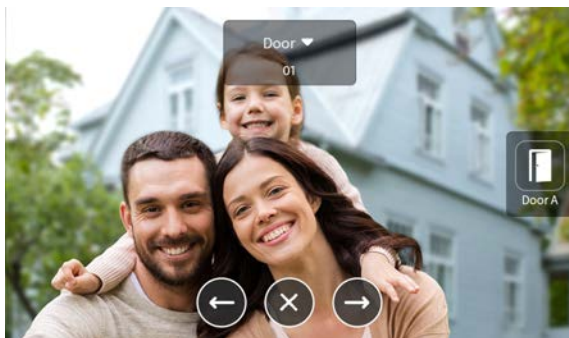

Click “” icon to search for the contact. Click “” icon to modify the existing contact information. Click “” icon to add a contact.

2. Monitor

Click “Monitor” icon on the main interface, the system will enter the following interface:





Click “Door01” icon to switch the type of door station, then click  or  icon to select the area you want to monitor. Click  icon to end monitoring. Click  icon to unlock the door.

Remark: The system’s default monitoring time is 25s.

3. Quad Splitter

Click “Quad Splitter” icon on the main interface, the system will enter the following interface:



Click any screen of IPC to make it full screen. Click  and  buttons to check other pages. Up to 16 IPC can be added.

4. Phonebook

Swipe the screen on the homepage from left to right to check Phonebook.



This interface allows you to view contacts in the phonebook.

5.Message

Click “Message” icon on the main interface, the system will enter the following interface:

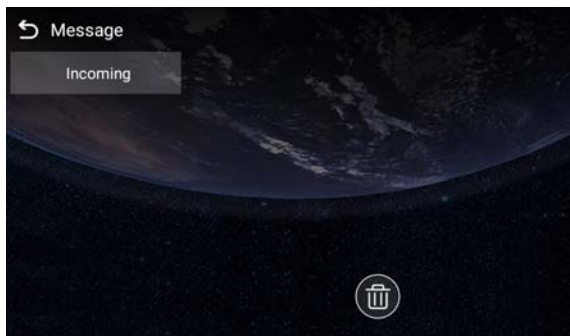

Note: Indoor monitor can only receive the message sent by the management software installed on the computer which is usually located at guard center.

Up to 64 records can be received in SMS.

6.QR Code

Click “QR Code” icon on the main interface, the system will enter the following interface:



Scanning the QR code with DNAKE Smart Life APP, it will be synchronized with the indoor monitor.

7.Security

Click “Security” icon on the main interface, the system will enter the following interface:

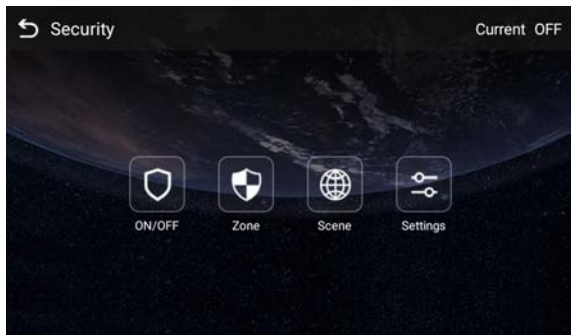

7.1 ON/OFF

Click “ON/OFF” icon, the system will enter into the following interface:

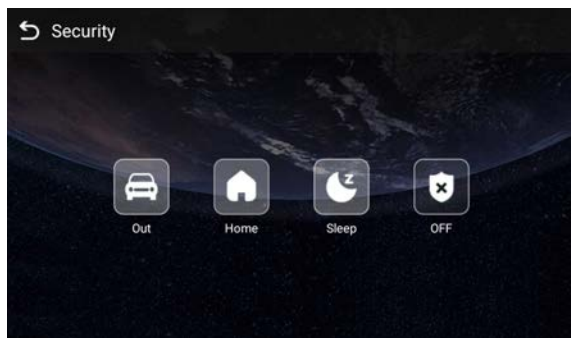

7.1.1 ON

Click “Out”, “Home”, or “Sleep” icon to activate the alarm sensors, the icon on the main interface will light up with a beep and stay lit.

7.1.2 OFF

(1) During delay time of the alarm, click “OFF” icon, the system will beep to distable the alarm.

(2) Input user password(the default password is 1234) to disable the alarm under alarm ON status.

7.2 Zone

Remark: the settings should be made when alarm is OFF.

Click “Zone” icon and input 1-16 digits password(the default password is 1234), the system will enter into the following interface:



No.	Type	Mode	Delay	Sensor
1	Normal ▼	3C ▼	0s ▼	Smoke ▼
2	Normal ▼	3C ▼	0s ▼	Smoke ▼
3	Normal ▼	3C ▼	0s ▼	Smoke ▼
4	Normal ▼	3C ▼	0s ▼	Smoke ▼

7.2.1 Alarm Type

Click Type, it will show as the following. In this interface, you can set alarm Type as: Normal, Emergency or 24H. 24H and Emergency types are always active.



No.	Type	Mode	Delay	Sensor
1	Normal ▼	3C ▼	0s ▼	Smoke ▼
2	Normal ▼	3C ▼	0s ▼	Smoke ▼
3	Normal ▼	3C ▼	0s ▼	Smoke ▼
4	Normal ▼	3C ▼	0s ▼	Smoke ▼

7.2.2 Mode

Click mode, it will show the following interface. In this interface, you can set mode as: 3C, NO, NC or BELL.



7.2.3 Delay Time

It refers to the delay time of giving an alarm. Click Delay setting, it will show the following interface with selections: 0s, 5s, 15s, 20s, 25s, 40s or 60s as the desired delay time. For example, select the delay time: 5s. Once the alarm sensor is triggered, the indoor monitor will issue the sirens after 5 seconds.



7.2.4 Sensor Type

Click sensor type, it will show the following interface. Each sensor type can be set up as: Smoke, Gas, PIR, Door, Window, Panic, Flood, Pull Cord.



7.3 Scene

Click "Scene" icon, the system will enter into the following interface:



refers to Alarm ON, refers to Alarm OFF. To set the sensor of alarm stations, you can click the corresponding station with icon. Click "Activation Time" to select the corresponding time. The options of activation time include NONE, 30s, 40s, 60s, 100s and 300s.



7.4 Settings

Click “Settings” icon, the system will enter into the following interface:



You can set the new system password with 1-16 digits (the default password is 123456). System password is used for system settings.

8. Concierge

Click “Concierge” icon on the main interface, the system will enter the following interface:



Call the master station directly.

9. Elevator

Click “Elevator” icon on the main interface, the system will enter the following interface:

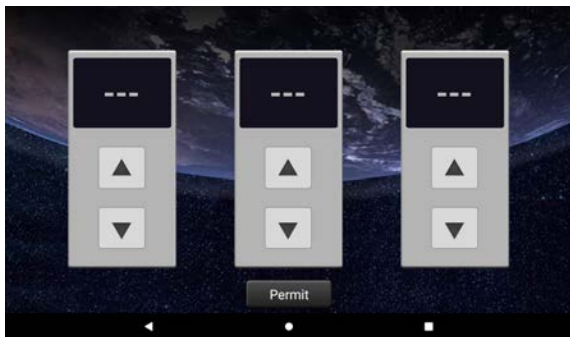

Click ▲ or ▼ icon to summon the elevator to go up and down. Click “Permit” icon to allow access to the floor where the indoor monitor is located.

Remark: To support this function, your system must connect with “Elevator Control” module. Kindly check with your system provider.

10.Settings

Click “Settings” icon on the main interface, the system will enter the following interface:

10.1 Display

“Brightness level” and “Sleep” mode time can be set.

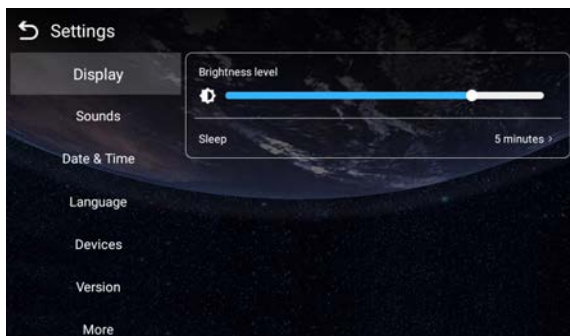

10.2 Sounds

Click “Sounds” icon, the system will enter into the following interface:

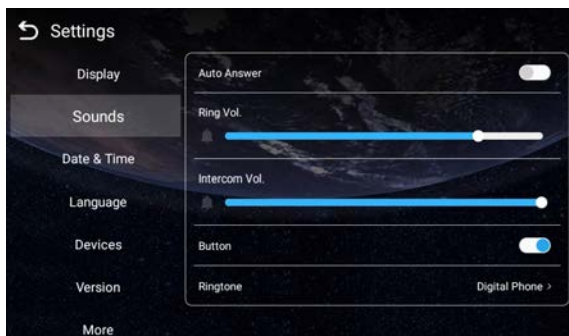

“Auto Answer”, “Ring Vol”, “Intercom Vol”, “Button” and “Ringtone” can be set.

10.3 Date & Time

Click “Date & Time” icon, the system will enter into the following interface:



This interface can set “Automatic date & time”, “Time Zone”, “12H/24H” and “NTP”.

10.4 Language

Click “Language” icon, the system will enter into the following interface:

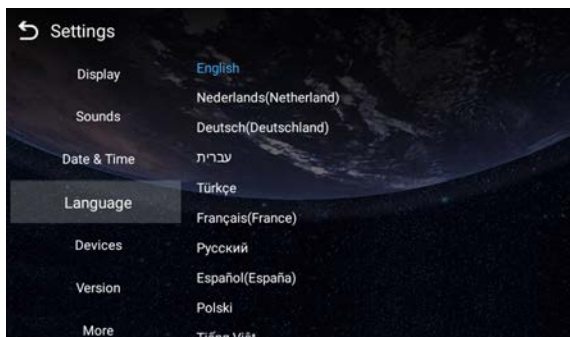

The system language can be switched.

10.5 Device

Click “Device” icon, the system will enter into the following interface:

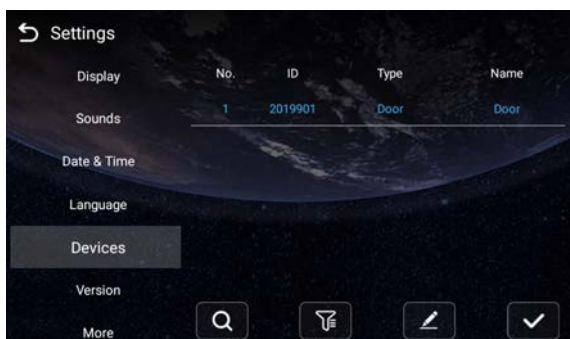

This interface allows you to view or edit device information.

10.6 Version

Click “Version” icon, the system will enter into the following interface:



This interface can view “FW”, “IP”, “WiFi IP” and “MAC”.

10.7 More

Click “More” icon, then input 1-16 digits password (the default password is 123456) to make the following settings:

10.7.1 Ethernet

Click “Ethernet” icon, the system will enter into the following interface:

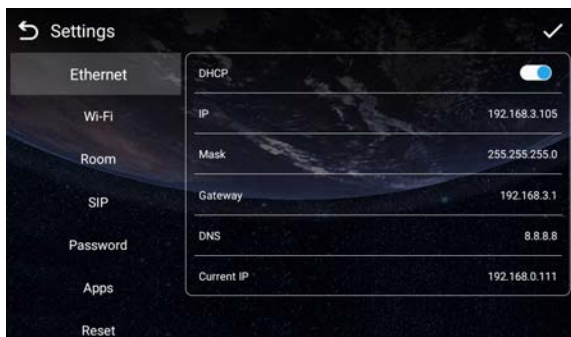

After using the **DHCP**, the router will automatically distribute IP address. Other settings are the same as the ones of DNAKE Smart Life APP.

IP: IP address is unique.

Mask: The default Mask address is 255.255.255.0. Normally, it can keep unchanged. To modify it, click the setting box twice, a keypad will pop up for entering new Mask address.

Gateway: The Gateway in one system must be in the same segment.

DNS: It refers to name resolution address (DNS of local operator). If the indoor monitor is used in external network, the address must be completed correctly; if it is used in internal network, the address can be ignored.)

10.7.2 Wi-Fi

Click “Wi-Fi” icon, the system will enter into the following interface:

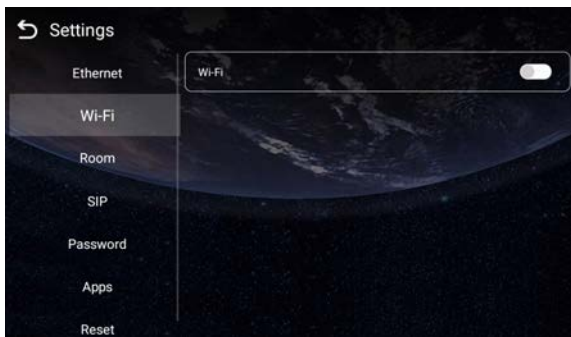

Wi-Fi function can be enabled or disabled.

10.7.3 Room

Click “Room” icon, the system will enter into the following interface:

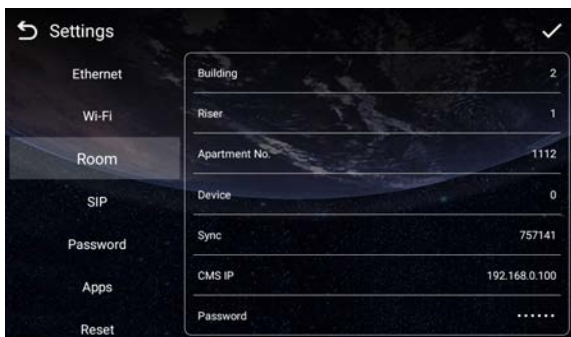

Warning: Please revise synchronous No.(6 digits) as soon as possible after you read the user manual. The synchronous No. of all indoor monitors in one household must be the same.

Input the 3-digit Building No. such as 001, and then click “OK” to finish the building No. setting.

The setting method of Riser No., Apartment No., Device No., CMS IP and Synchronous No. is the same as the one of Building No.. When Device No. is set to be 0, the indoor monitor is regarded as the main; when Device No. is set from 1 to 5, the monitor is regarded as the sub1 to sub5.

10.7.4 SIP

Click “SIP” icon, the system will enter into the following interface:

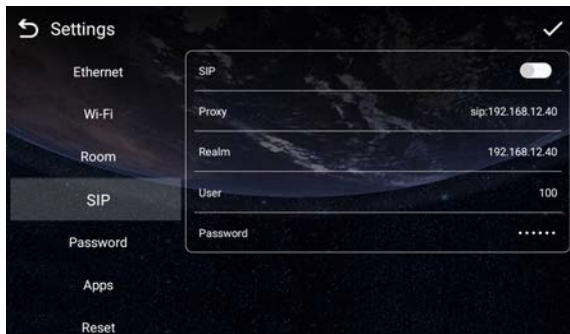

Proxy: URL of sip proxy server, format in sip: ip or sip: realm name.

Realm: the scope for the device, same as IP or realm name.

Password: the password to access proxy server, offered by the administrator of sip proxy server.

10.7.5 Password

Click “Password” icon, the system will enter into the following interface:

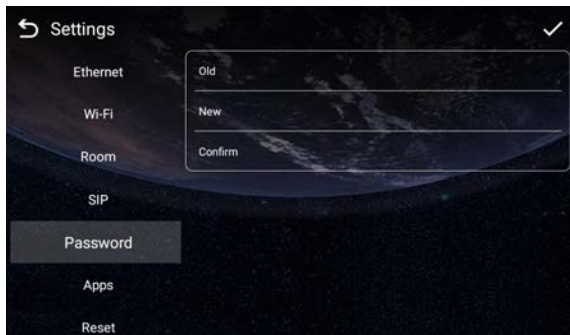

You can set the new system password with 1-16 digits (the default password is 123456). System password is used for system settings.

10.7.6 Apps

Click “Apps” icon, the system will enter into the following interface:

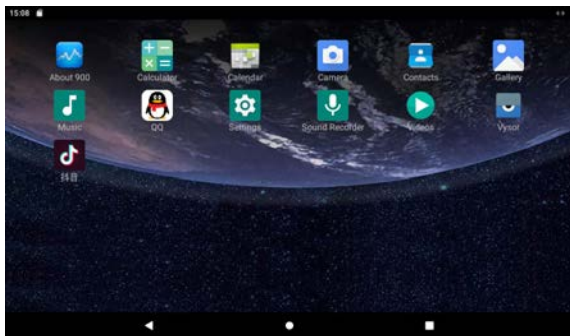

All 3rd-party apps will be installed here including pre-loaded apps such as About 900, calculator, Calendar, Camera, Contacts, Gallery, Music, Settings, Sound Recorder and Videos.

10.7.7 Reset

Click “Reset” icon, the system will enter into the following interface:

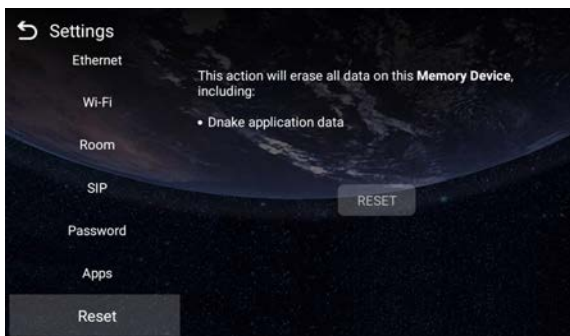

Clicking “Reset” icon will erase all data on this device.

WEB SETTINGS

Connect the indoor monitor and computer by network switch. Input the indoor monitor's IP address in the browser, then input user name and password (the default user name is "admin", the password is "123456") to enter into the web setting interface.

Main page is used for showing firmware version and the status of SIP registration.

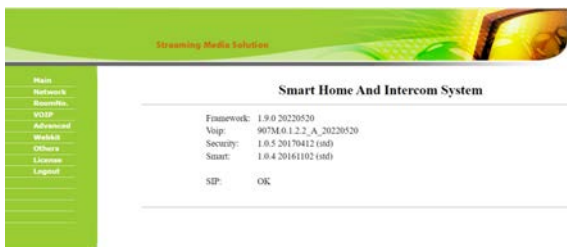

1. Network



Network page is used for setting up network of device here.

DHCP: obtain IP address via DHCP;

IP: static IP address;

Mask: subnet mask;

Gateway: gateway;

DNS: Domain Name Server;

Eth & WiFi: switch to activate network port and WiFi of the device to work simultaneously.

2. RoomNo

The screenshot shows the 'Room No. Settings' page. On the left is a green navigation menu with options: Home, Network, RoomNo, VOIP, Advanced, Monitor, Others, License, and Logout. The main content area has a header 'Streaming Media Solution' and a sub-header 'Room No. Settings'. The form contains the following fields: Build (1), Unit (1), Room (111), Device (0), Sync (127822), Server (192.168.12.40), and Password (123456). A 'Submit' button is at the bottom.

RoomNo page is used for setting up connection with other devices.

Build: number of the building;

Unit: number of the unit;

Room: number of the room;

Device: the numbering system for same-room number devices (Indoor Monitor 0-9; Outdoor Station 1-9);

Sync: type in same numbers to make same-room number Indoor Monitors ring together;

Server & Password: server is the IP of CMS and password is the admin's password of device.

3. VOIP

The screenshot shows the 'SIP Settings' page. On the left is a green navigation menu with options: Home, Network, RoomNo, VOIP, Advanced, Monitor, Others, License, and Logout. The main content area has a header 'Streaming Media Solution' and a sub-header 'SIP Settings'. The form contains the following fields: SIP enable (checkbox), Proxy (192.168.12.40), Realm (192.168.12.40), Outbound (sip), User (100), Password (*****), Timeout (300s), and Voice Mailbox (224.0.3.1.9001). A 'Submit' button is at the bottom.

VoIP page is used for setting up SIP.

SIP enable: switch to enable or disable SIP;

Proxy: fill server address and port, the format: sip:server address:port;

Realm: fill server address and port, the format: server address:port;

Outbound: if you don't have outbound server, leave it blank;

User & Password: account and password of SIP;

Timeout: maximum call duration;

Voice Multicast: fill voice gateway to receive voice broadcast.

4. Advanced

Streaming Media Solution

Home
Network
Account
SIP
Advanced
Monitor
Software
License
Logout

Advanced Settings

Ex Phone:

Auto Pickup:

ONU Pass:

Deaf Mode:

Quick Call:

URL:

RTSP Feed:

Local Relay Delay:

Local Relay Type:

Unlock Button 1:

Name:

Type:

Unlock Button 2:

Name:

Type:

Unlock Button 3:

Name:

Type:

Install Third-party App:

Advanced page is used for setting up accessibility features.

Ex Phone: add other brand's IP Phone as SIP extension (4 devices supported);

Auto Pickup: pick up automatically when receiving a call;

ONU Pass: if using optical cable but not network cable in the building, it should be enabled;

Deaf Mode: enable this when Indoor Monitor connecting a lamp for ringing;

Quick Call & URL: call the corresponding URL by management-center button or icon;

DTMF Unlock & DTMF: enable sending DTMF command;

RTSP Feed: the video source of the Indoor Monitor when call another Indoor Monitors.

Local Relay Delay: delay duration of unlock;

Local Relay Type: type of local relay (Open Door is for lock/Chime Bell is for doorbell);

Unlock Button 1-3: enable or disable relays for unlock buttons;

Name 1-3: customize relays' name;

Type 1-3: 3 types of unlock way is optional (Local Relay/DTMF/HTTP)

Note: the format of HTTP is `http://192.168.1.63/cgi-bin/ext/control.cgi?op=unlock`

IP here is an example of Door Station's IP);

Install Third-party App: install 3rd-party apps on Indoor Monitor. Click Choose File to select apk file and install.

5. Others



Others page is used for reboot.

Reboot: click to reboot the device.

6. Logout



Logout page is used for signing off.

User Logout: click to logout the webpage. After that, you can use other accounts to login.

SYSTEM CONFIGURATION

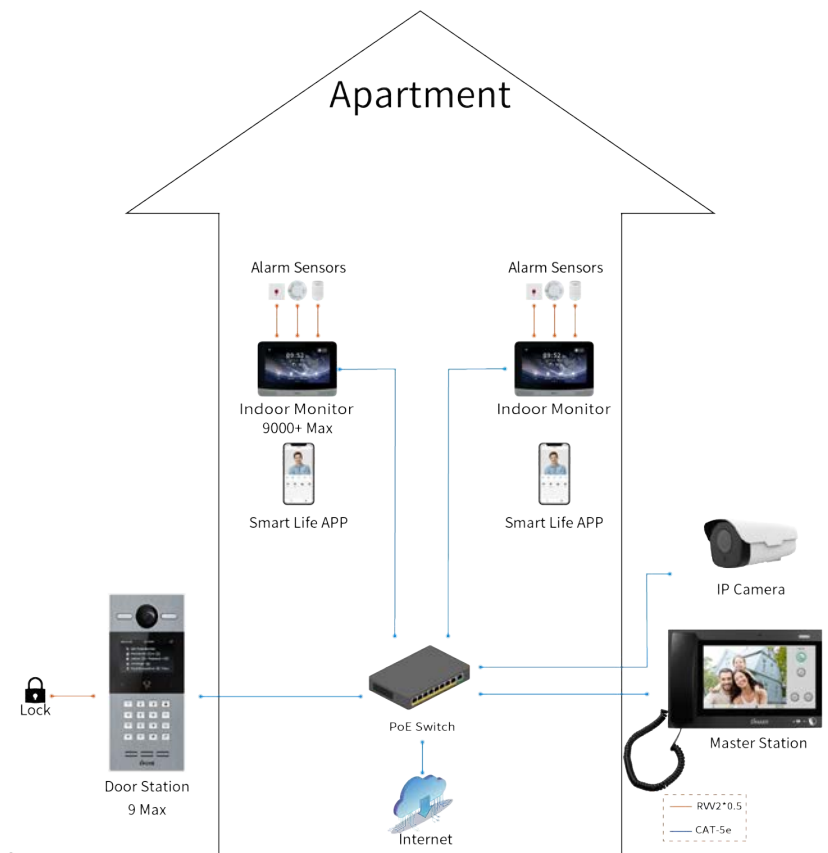

SYSTEM DIAGRAM

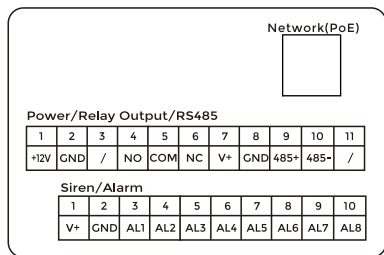

A416(Single Network Port)

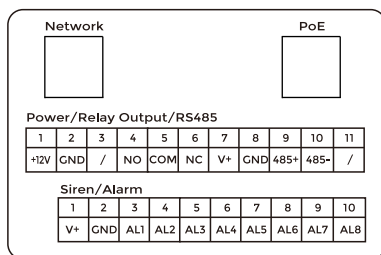

A416(Dual Network Ports)

1. Network/PoE

Connect with door station, indoor monitor or other network equipment by network switch.

When indoor monitor has PoE function, the interface can supply power by connecting with PoE network switch.

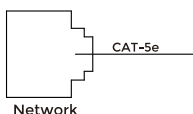

2. Power

Power input interface: connect with 12V power adapter.

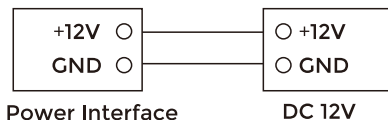

3. Relay Output

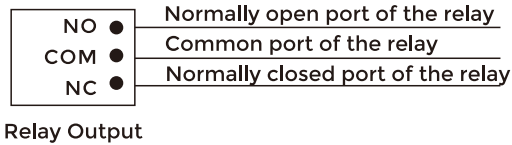

4. RS485

Connect with RS485 interface device;

RS485 interface can output 12V/100mA power supply. If RS485 equipment to be connected doesn't require the power supply, no need to connect +12V.

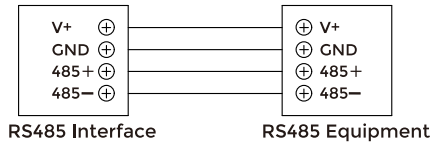

4. Siren/Alarm

Interface of alarm zones connects with normally-open or normally-closed switch.

When the alarm zone is triggered, it will output 12V/100mA power.

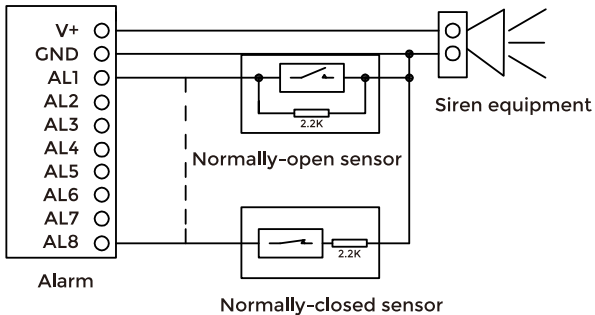

INSTALLATION

MODEL: A416(Surface Mounting)

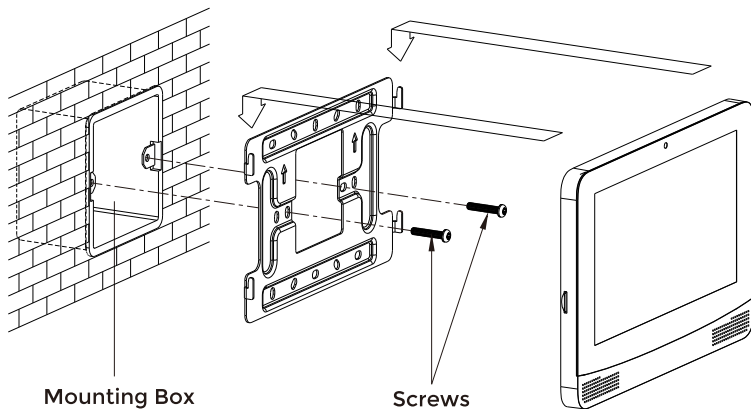

Product size: 189.5x132x15mm

Installation Instructions:

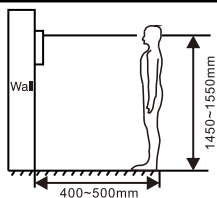

[Suggestion]: The camera should be 1450~1550mm above the ground. The camera at this height can capture human face perfectly.

MODEL: A416(Desktop Mounting)

Assemble the hooks on two sides of the bracket into the groove on the rear cover.

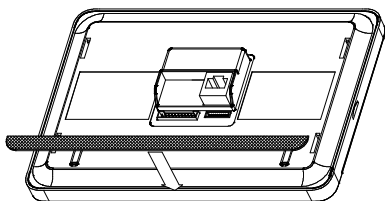
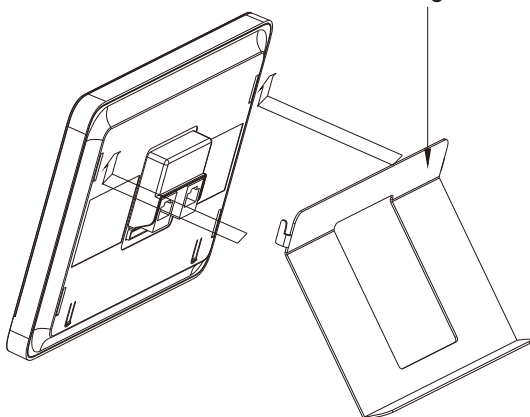

Align the edge of the silica gel pad with the lower edge of the casing, and paste the pad.

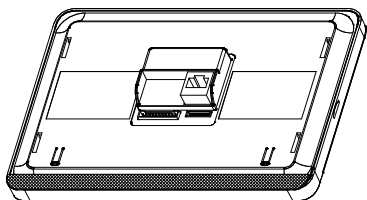
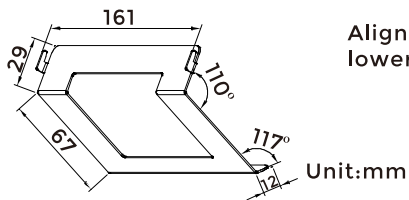

Product size: 195x130x14.5mm

TROUBLESHOOTING

The indoor monitor cannot start up or power off automatically.

- Check whether it has power-failure, and power it on again.
-

The indoor monitor display screen is too dim.

- Check whether the brightness and contrast settings of screen are correct.
-

No sound during the communication.

- Check whether the indoor monitor is set as mute mode, or the volume is set to the lowest.
-

The indoor monitor cannot monitor the outdoor panel.

- Other user is using the system, so you can use it once he/she finished the operation.
-

Multimedia files cannot be played normally.

- Check whether the system supports the file format. Please refer to multimedia setting for details.
-

No response when clicking indoor monitor display screen.

- Press “Unlock” button for 5s, or slowly slide horizontally or vertically on the LCD to make touchscreen calibration. It needs to be calibrated twice.
-

Touchscreen responses slowly or cannot make calibration.

- Take down any protective paster, since it may affect identification and input for device;
 - Ensure the finger is dry and clean when clicking touchscreen;
 - Restart the device to clear any temporary software error.
-

The temperature of device is too high.

- Long-term use leads to high emperature. It's normal and will not affect the device's use life and performance.

SAFETY INSTRUCTIONS

In order to protect you and others from harm or your device from damage, please read the following information before using the device.

Do not install the device in the following places:

- Do not install the device in high-temperature and moist environment or the area close to magnetic field, such as the electric generator, transformer or magnet.
- Do not place the device near the heating products such as electric heater or the fluid container.
- Do not place the device in the sun or near the heat source, which might cause discoloration or deformation of the device.
- Do not install the device in an unstable position to avoid the property losses or personal injury caused by the falling of device.

Guard against electric shock, fire and explosion:

- Do not use damaged power cord, plug or loose outlet.
- Do not touch the power cord with wet hand or unplug the power cord by pulling.
- Do not bend or damage the power cord.
- Do not touch the device with wet hand.
- Do not make the power supply slip or cause the impact.
- Do not use the power supply without the manufacturer's approval.
- Do not have the liquids such as water go into the device.

Clean Device Surface

- Clean the device surfaces with soft cloth dipped in some water, and then rub the surface with dry cloth.

Other Tips

- In order to prevent damage to the paint layer or the case, please do not expose the device to chemical products, such as the diluent, gasoline, alcohol, insect-resist agents, opacifying agent and insecticide.
- Do not knock on the device with hard objects.
- Do not press the screen surface. Overexertion might cause flopper or damage to the device.
- Please be careful when standing up from the area under the device.
- Do not disassemble, repair or modify the device at your own discretion.
- The arbitrary modification is not covered under warranty. When any repair required, please contact the customer service center.
- If there is abnormal sound, smell or fume in the device, please unplug the power cord immediately and contact the customer service center.
- When the device isn't used for a long time, the adaptor and memory card can be removed and placed in dry environment.
- When moving, please hand over the manual to new tenant for proper usage of the device.

 **EASY & SMART
INTERCOM SOLUTIONS**