

Explorer/Patroller Plus Power Kit

USER GUIDES|MANUALS

V1.0 2022.02



Waydo Technical Support
This guide may be updated without notice.
Check the official Waydo website for the latest version.
www.waydotech.com

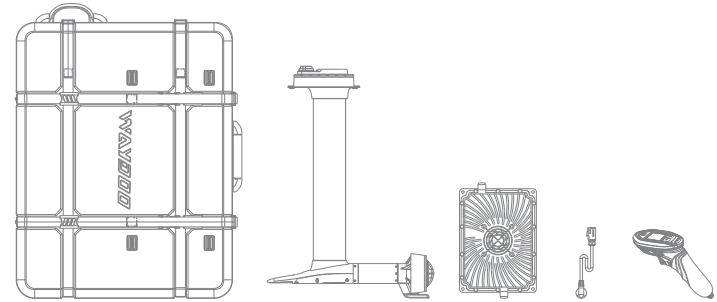

Content

Disclaimer	2
Explorer/ Patroller PLUS Power Kit	3
Parts	4
Assembly steps	8
Carrying case	10
How to use	11
Maintenance	12
Safety Guidelines	13
Troubleshooting	16

Disclaimer

Please read this manual and related warnings carefully before use. This product concerns water sports equipment. Using this product has inherent risks that may cause serious injury or even death. Users who use this product must understand and accept the inherent risks of using this product. Misuse of this product may cause product damage or personal injury. As a continuous effort of product development, Waydoo reserves the right to change the components, specifications or other aspects of this product without prior notice. For more information, please visit: www.waydootech.com.

EN

WARNING







Minors under the age of 18 are not suggested to use this product. A safety summary as part of the operating safety knowledge is included. Please read the entire content of the disclaimer and safety operating instructions carefully. After reading the entire user manual, familiarize yourself with the functions of the product before proceeding. This product can cause serious injury to oneself or others, or cause product damage and property loss. This product can only be used safely with instructions clearly in mind, and it requires some basic common sense before operation. Do not use parts that are not provided or recommended by Waydoo, and strictly follow Waydoo's instructions to install and use the product. This guide contains instructions on safety, operation, and maintenance. Make sure to carefully read all instructions and warnings in the user guides before assembly, setup, and use.

Waydoo Flyer ONE Plus

Introduction

Waydoo Flyer ONE Plus series products are the upgraded EFOIL products of Waydoo Flyer ONE. This series includes a power kit, board, battery, wings, and other sub-products. These four sub-products need to be combined to form a complete set of EFOIL products. Users can select from our range of parts and components to build the kind of ride that's tailored to their needs. Except for Waydoo Lithium Battery Charger, PowerFlight battery and wings, we do not recommend that users mix and match Waydoo Flyer ONE's sub-products with Flyer ONE Plus's. This manual is for Plus Power Kit. The explorer/ patroller plus power kit shall be referred to as "Plus power kit" in this manual.

Components

- Waydoo Lithium Battery Charger 
- Plus Power Kit 
- Controller plus 
- Controller plus charging cable 
- AC Power cord 
- Tool kit 

EN

Parts

Controller Plus

The Controller Plus is ergonomically designed and adopts a LCD display interface. The display shows the power level of the PowerFlight Battery and the Controller Plus. The Controller Plus displays Bluetooth connection and flight speed. It offers 24 speed gears.

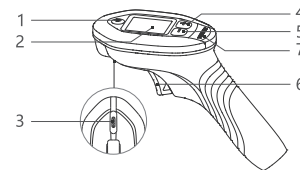

- 1. Power Button
- 2. Display
- 3. Magnetic Charging Port
- 4. "+" Speed Gear
- 5. "-" Speed Gear
- 6. Trigger
- 7. Indicator light

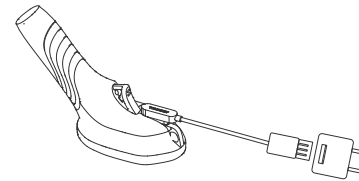

1. Remove the Controller plus charger cable from the Tool kit.
2. Plug in a USB charger and attach the magnetic charging plug to the Controller plus, ensuring the charging pins are connected.
3. When the Controller plus is charging correctly, the light on the top will be on. The charging time is 3 hours.

Controller Plus Display

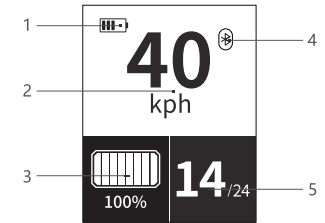

- 1. Controller Plus Power Level
- 2. Speed
- 3. PowerFlight Battery Power Level
- 4. Bluetooth connection
- 5. Speed Gear

Remarks:

1. Power on the Controller Plus: Press and hold the power button on the Controller Plus for 5 seconds until the screen is fully lit.
2. When the Controller Plus is not connected, the Bluetooth icon on the display continues to flash until it is connected.

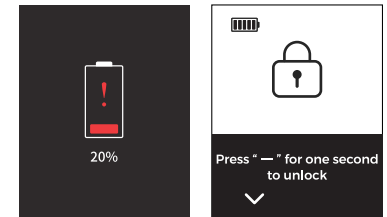

Remarks:

1. When the battery power of the Controller Plus is lower than 20%, a low-battery warning box appears, please charge it in time.
2. When the Controller Plus is on standby for more than 8 seconds, the throttle of the controller will be locked. Press and hold "-" for 1 second to unlock.

EN

3. If the controller is disconnected due to the user falling into the water or other reasons, and there is no command from throttle within 1s after the controller is reconnected, the controller will also be automatically locked.

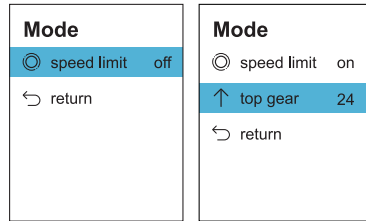

After entering the sub-menu, use "+" or "-" to scroll and press the Power Button to select the Mode. Press "+" or "-" to switch and press the Power Button to confirm. The highest gear can be adjusted in speed limit mode.

Finally press "+" or "-" to scroll to the return option, and press the Power Button to confirm until you exit the Settings.

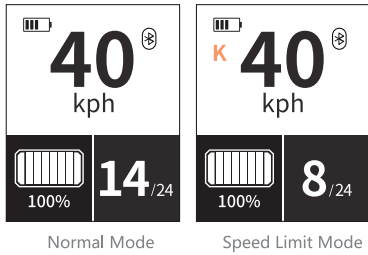

The Controller Plus offers 24 speed gear option. In speed limit mode, speed options can be limited to 10 gears, and the highest gear can be adjusted.

Working Mode Setting

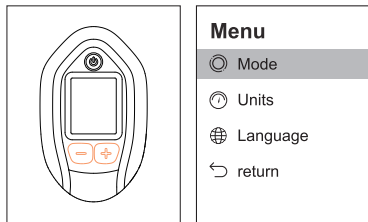

Short press "+" and "-" simultaneously when the Controller Plus is powered on to enter Settings. Scroll through the menu by pressing the "+" or "-" and press the Power Button to confirm.

Units Setting

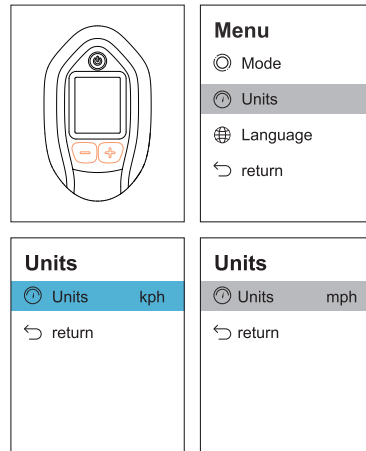

Language Setting



PowerFlight Battery

Powerflight battery is a smart battery specially designed for Waydoo Flyer ONE Efoil products. It supports uses on Flyer ONE and Flyer ONE Plus products. It adopts a plug-in-free design and is easy to install. The fully waterproof design ensures that the battery is free from seawater erosion when in use. The PowerFlight battery is not included in this plus power kit. It needs to be purchased separately.

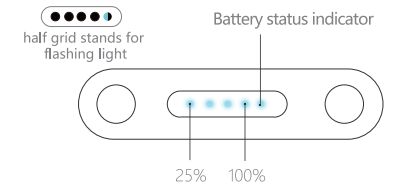
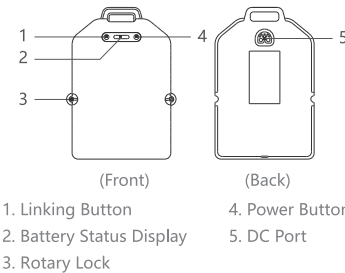

When your battery fails to be charged, please short press the power button six times to check the cause of the failure.

Status Light	Light meaning
Blue light flashes 3 times	Fully charged
Blue light flashes 4 times	Set up to be charged to 80%
Blue light flashes 5 times	Charger fault
Blue light flashes 6 times	Battery self-protection
Blue light flashes 7 times	Non-battery error

Self-discharge

Self-discharge means that the battery's charge gradually reduces over time during storage, which extends battery life for better usability.

Status Light	Light meaning
Blue light flashes once	Self discharge to 70%(automatically)
Blue light flashes twice	Self discharge to 30% (short press power button 4 times and long press to set up and cancel)

Battery capacity

One grid represents 25% power; half grid (blue light flashing) represents 12.5% power

LED Light	Light meaning
●●●●	capacity 87.5%-100%
●●●●	capacity 75%-87.5%
●●●●	capacity 62.5%-75%
●●●●	capacity 50%-62.5%
●●●●	capacity 37.5%-50%
●●●●	capacity 25%-37.5%
●●●●	capacity 12.5%-25%
●●●●	capacity 0-12.5%

Battery Fault indicator

Status Light	Light meaning
Red light flashes 2 times	Under voltage protection (please charge your battery in time)
Red light flashes 3 times	Over-temperature protection (please cool down the battery before charging)
Red light flashes 4 times	Over current protection (the battery will automatically recover after 30 seconds)
Red light flashes 5 times	Short circuit protection (please reboot your battery)
Red light flashes 6 times	Over voltage protection (please stop charging)

If there are other abnormal lights not on the above, please contact Waydoo after-sales in time.

Waydoo Lithium Battery Charger

Adopting an aluminium alloy diecasting, the Waydoo Lithium Battery Charger has an input voltage of 100-240V, output voltage of 58.6V-58.8V, charging current of 16-17A, and a protection level of IPX6.

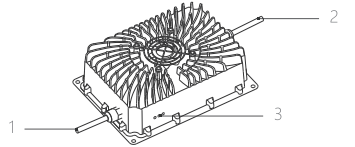

1. DC cable 2. AC Cord 3. Indicator

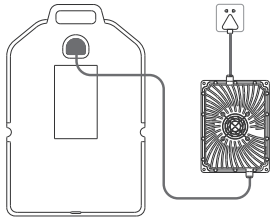

Charging the PowerFlight Battery

1. Place PowerFlight battery in a cool dry location away from flammable or hot items.
2. Connect the charger's DC cable to the battery's DC port, press firmly to install it in place, and place the battery face up on the hard ground.
3. Plug the AC cord into a wall outlet.
4. The charger power indicator shows a steady blue light, indicating standby mode.
5. Short press the linking button on the PowerFlight battery, and the indicator will change from steady blue light to a flashing blue light, waiting for communication.
6. When the flashing blue light turns to flashing green, the battery is now charging.

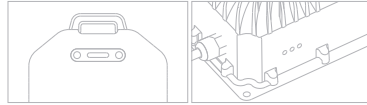

7. When the Waydoo Lithium Battery Charger indicator changes from flashing green to steady green, it means that the PowerFlight Battery charge fully. The PowerFlight Battery usually takes 2 hours to charge fully. When the indicator flashes red on the charger, it means the PowerFlight Battery is malfunctioning. Stop charging immediately if this occurs.

Healthy charging mode

If the battery will not be used in a short time, you can start the healthy charging mode to extend battery life for better usability. When the battery power reaches 80%, it will automatically stop charging.

Step

1. Press the battery power button four times during the charging process.
2. The blue indicator light will flash back and forth from the middle to the end.
3. The healthy charging mode is activated.

Note: This healthy charging mode is valid for a single time after activation.

Plus power kit

Plus power kit is specially designed for Waydoo Efoil products, integrating a brushless motor, motor driver, propeller, main control board, Bluetooth communication modules, etc. With a waterproof and quick-installation design, the plus power kit can be easily installed on Waydoo Efoil products with L-shaped bolts. The front and stabilizer wing can be installed on the corresponding mount with special screws.

Standard combination

- 25.6-inch mast & explorer wing
- 31.5-inch mast & patroller wing

Users can freely select different front wings and masts according to their needs.

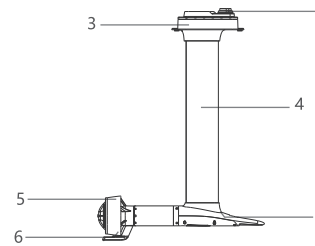

1. DC Port 2. Front Wing Mount
3. Mast Head 4. Support Rod
5. Propeller Guard 6. Stabilizer Wing Mount

Propeller Replacement Steps

If your propeller is damaged and needs to be replaced, please follow the below steps to replace it.

Tool: M4 Allen Screwdriver

1. Turn the propeller protective cover clockwise to remove it from the propeller guard.
2. Remove the bullet. Unscrew it from the motor shaft with an M4 Allen screwdriver, and remove the current propeller.
3. Remove the current propeller pin and replace it with a new pin. Insert the pin into the cross hole located on the propeller shaft at the motor output. Center the pin on the motor shaft.
4. Reassemble the propeller: Take a new propeller (confirming that it has no defects such as deformation or scratches), and assemble the propeller. Note that the direction of the propeller groove should be consistent.
5. Reassemble the new bullet and the propeller protective cover, and the propeller replacement is done.

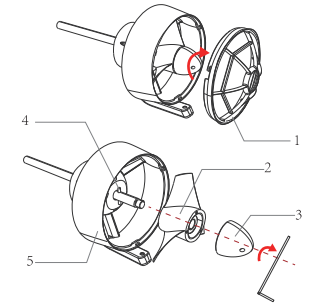

1. propeller protective cover
2. propeller 3. bullet 4. propeller pin
5. propeller guard

Assembly Steps

Plus power kit is specially designed for Waydoo Efoil products. It is compatible with both standard board and premium board. The below takes the standard board as an example to explain how to install and use it.

Please strictly follow the following installation steps.

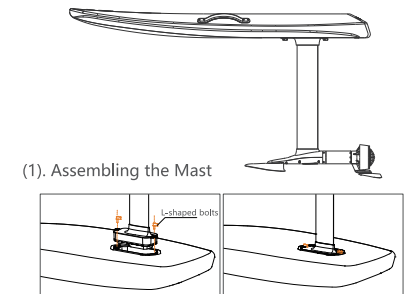

1. Turn the Board over to insert the Plus power kit vertically into the mast installation hub.
2. After inserting the mast head into the hub, make sure it fits, fixes with L-shaped bolts and tighten.

Note: Before installing, please make sure the mast DC port is free of any water and debris. (Clean and dry it if necessary)

(2). Assembling the Wings

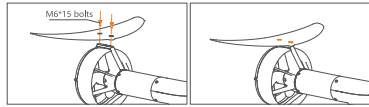

1. Attach the Stabilizer Wing on the stabilizer mount and tighten the two M6*15 bolts clockwise with the 4mm Hexagon Wrench.

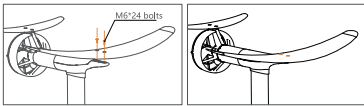

2. Put the Front Wing on the front mount and tighten the two M6*24 bolts clockwise with the 4mm Hexagon Wrench.

3. Flip over the Board and proceed to the next step.

(3). Installing the PowerFlight Battery

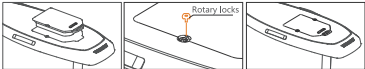

1. Face the PowerFlight battery compartment upward and reset both Rotary Locks.

2. Insert the PowerFlight Battery into the battery compartment. Turn both Rotary Locks 180-degrees to securely lock the battery in place.

Note: Before installing, please make sure the battery DC port is free of any water and debris. (Clean and dry it if necessary)

(4). Connecting the Controller Plus



Controller plus and Plus power kit have been paired with each other before leaving the factory. They will be automatically connected when the PowerFlight battery and controller plus are turned on. If the controller plus does not connect to the plus power kit, please manually pair them by following the standard pairing process.

9 © All rights reserved by Waydo

1. Press the Power Button on the Controller Plus for 5 seconds. Power on the Controller Plus.

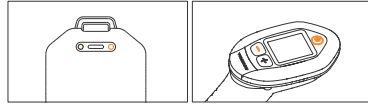

There are two ways to operate the **short press** and **long press**.

short press = Place the correct side(the side that attracts the battery buttons as figure 1) of the magnet keychain on the button once or use your finger to press the button once.

long press = Place the correct side of the magnet keychain on the button until the operation is complete or use your finger to long press the button.

2. Power on the PowerFlight battery. Short press once and long press until you see the battery status light is on.

figure 1

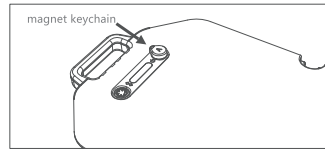

3. Within 1 min after the battery is turned on, short press and long pres the linking button. When you hear a long beep from the buzzer, it means that you enter the linking mode. (The battery will need to be rebooted if the operation is timeout. Perform the above step again).

Note:

1. We recommend using a magnet keychain to complete the power-on and pairing operations to prevent sand from entering the battery buttons, which leads to the buttons getting stuck.

2. The use of battery buttons is a backup operation.

4. For Bluetooth pairing, simultaneously press and hold the Power Button and “-” Button of the Controller Plus. When the Bluetooth icon disappears, it means the pairing is successful.

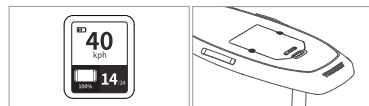

Components

1. Waydoo Lithium Battery Charger
2. Plus Power Kit
3. Controller plus
4. AC Power cord
5. Tool kit
6. Wheels

How to use the carrying case to carry the whole Waydoo product

1. Press the flash lock to release the buckles and separate the webbing to open the case.
 2. Take out of the charger, and you can place the battery on that compartment. Place the stabilizer wing under the plus power kit. Place the front wing on the upper cover, make sure it fits the position, and fasten the belt.
 3. Take out of two wheels.
 4. Close the case. Connect the two sides of the webbing by pushing the buckle A back together.
 5. Fasten the board onto the carrying case.
 - Press the quick-release spring lever to loosen the strap.
 - Put the board on the carrying case with EVA pad and upper cover facing each other to ensure it is non-slip.
 - Push the buckle B back together and adjust the length of the strap to ensure that the board is tightly closed to the case. Then attach the Velcro hook part to the loop part.
- Note: make sure the rubber cover contacts with the edge of the board
6. Simply pull the handle, and you can carry the whole Waydoo product.

Download Waydoo app

The Waydoo App is available to download in the Apple store and google play store.

https://play.google.com/store/apps/details?id=com.waydoo.waydoo_app

<https://apps.apple.com/us/app/waydoo-app/id1538543262>



Connect to the Waydoo app to activate your Waydoo Flyer ONE Plus. If your WFO Plus is not activated, you will be limited to a speed gear of 4.

Carrying case

This power kit carrying case also serves as a wheeled carrying case with a handle for your Efoil. Detachable-wheel and special belt-fasten design, this carrying case allows users to transport a complete set of Waydoo Efoil products. Users can simply place the power kit, PowerFlight battery, controller plus, wings, etc. inside the carrying case, fasten the board on the carrying case. Separate design to avoid squeeze between the board and plus power kit. Made of EPP material, it avoids the collision and friction between the board body and the carrying case.

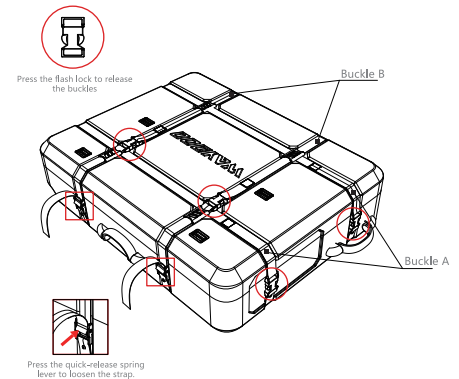
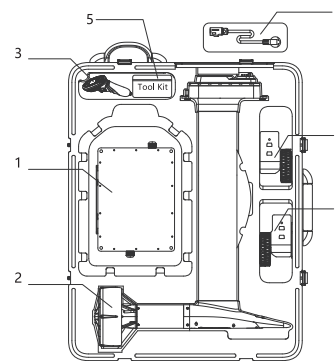

Place the stabilizer wing under the plus power kit

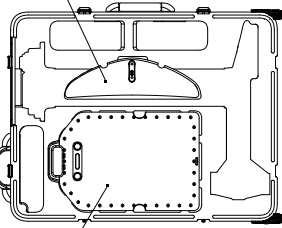

This compartment is also for PowerFlight battery

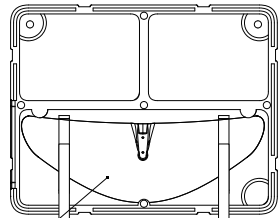

This compartment is for front wing

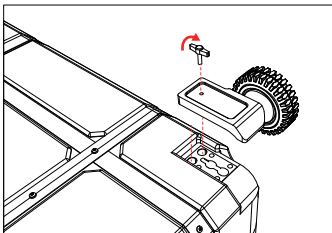

Install the two wheels

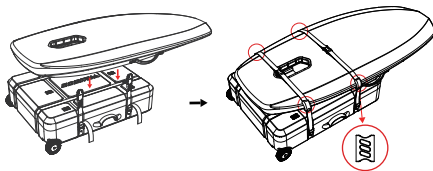

Fasten the board onto the box.

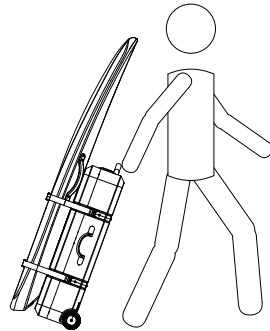

Simply pull the handle, and you can carry the whole Waydoo product.

How to use

Select a suitable riding location. It is necessary to select a location with sufficient water depth, approximately 1.5m that is free of obstacles on or below the surface. Choose a location away from swimmers and other water users.

Ensure local laws allow the motorized craft to be used in the area. A life jacket and safety helmet are highly recommended to be worn during the whole practice. When you are about to lose balance, try to fall on the same side of the board that tends to flip to, to avoid being hit by the board.

Riding the Efoil

Please follow the below steps:

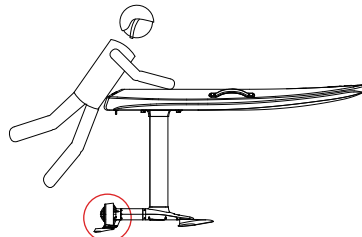

1. Getting familiar with the board. It is recommended that users climb up the board from the backside. Be careful not to kick the wings or mast.



2. Long press "-" to unlock the Controller plus.



3. On-board practice: Set the suitable gear. It is recommended that beginners familiarize themselves with a gear lower than 5. Slowly pull the trigger, and the propeller will start.

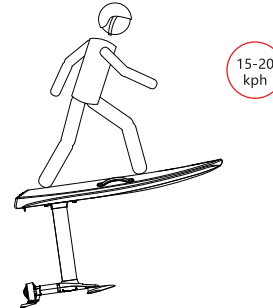

4. Slow gliding practice: Adjust the speed through the gear. When the flight speed reaches about 15kph, slightly tilt the front of the board. You can take off.

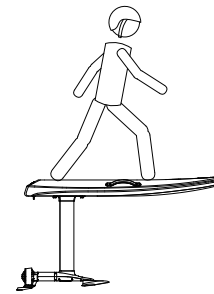

5. After taking off, adjust the height and direction of the flight by shifting your weight.

Note: To obtain a better wireless signal connection, the front of the board should be exposed to the water as much as possible during the flight. Beginners need a certain amount of training to slowly master the skills and reach the flight action of Steps 4 and 5. It is recommended that beginners spend more time practicing.

Maintenance

Regularly check the waterproof components (such as the Controller Plus, the PowerFlight Battery, and the mast head) for damage and the status of each module of the power system and control system.

1. After using the product, turn off the Controller Plus and PowerFlight Battery.
2. To clean the Plus Power Kit, please flush the mast body with a fresh water pipe for about 1 min to ensure that there is no seawater residue on the body to prevent corrosion. Rinse the mast head to ensure that the mast head is clean and free of debris; rinse with fresh water and clean the DC port of the mast with an alcohol swab to ensure that the DC port is dry and free of debris. Clean the motor shroud, propeller, and propeller protective cover with fresh water. Make sure to remove any salt, sand or other debris.
3. Rinse the board body with a fresh water pipe for about 1 minute, and clean the battery compartment and mast mounting hub and other parts to ensure that there is no salt, sand or other debris remaining. Then wipe it dry with a dry towel and let it stand in a dry environment to remove the remaining water.
4. Clean the battery, use fresh water to rinse the appearance of the battery. Use a cotton swab dipped in a little alcohol to clean the battery DC port and buttons. Wipe the battery with a dry towel and let stand in a dry environment to remove the remaining water.
5. Clean the Controller Plus. Pay special attention to the location of the trigger. If you find that there is a jam when pulling the trigger, check whether there is any gravel in the trigger. If so, rinse the gravel out with clean water.
6. After cleaning, wait for the moisture of all parts to dry before putting the parts back into the package.
7. When storing this product, avoid direct sunlight. Ultraviolet rays and high temperatures will cause permanent damage to the product.
8. To ensure safety, make sure to turn off the remote control and battery, and when transporting this product, do not install the battery on the board.

Safety Guidelines

1. Safety Summary

1. Refer to the user manual and watch the official instructional video to learn how to use this product.
2. This product can only be used on water. Take safety measures when using this product and wear a life jacket and safety helmet.
3. The use of this product requires a water depth of at least 1.2 meters. Be aware of gravel, plants, or wild animals in the water.
4. When using the product, pay attention to the surrounding environment, stay away from the shore, and keep a safe distance from ships and other people.
5. Do not use this product in waters where there are swimmers or divers.
6. Do not use this product in waters with floating objects, obstacles, or many wild animals and plants.
7. Do not use damaged or malfunctioning products.
8. Do not place the product directly on the roof of the car for transportation. Otherwise, the product may slide off and cause serious damage.
9. Do not use this product before fully understanding the operation steps and inherent risks of the product.
10. Do not allow others to use this product unless they fully understand how to use the product correctly.
11. Do not remove the propeller guard.
12. Do not attempt to fix or touch the propeller in the water.
13. Do not remove the battery when the product is in the water.
14. When the system is powered on, keep the propeller away from your body, fingers, and toes. The rotating propeller may cause serious, or even life-threatening, injury. Treat with caution.
15. When used in the water, any contact with the plus power kit, front wing or stabilizer wing may cause serious, or even life-threatening, injury. Treat with caution.
16. Do not use this product in bad weather. Pay attention to changes in weather when using this product.
17. Always use this product steadily and safely. Do not perform dangerous operations such as overspeeding or sharp turns.
18. During the use of product, the deadweight of the product shall not exceed 100kg.

2. Things to Know Before Use

Before using this product, check the product to ensure that the waterproof components (such as the Controller Plus, the PowerFlight Battery, and the mast head) are not damaged, the power system and control system work normally, the battery power is sufficient, and the bolts of each component have been tightened. Do not use damaged products.

1. Check whether the connection position of the plus power kit is firm and the bolts are tightened in place.
2. Make sure that the propeller and protective cover are not damaged or cracked, and carefully remove any sand or debris residue.
3. Install the PowerFlight Battery in the designated location.
4. Make sure the PowerFlight Battery is installed firmly and the lock is tightened in place.
5. Make sure the product is free of damage and is working properly before use.

3. Special Warning

1. Use original accessories or accessories certified by Waydoo. The use of non-original accessories may cause danger to the safe use of the hydrofoil.
2. Make sure no foreign matter (such as water, oil, sand, or soil) has entered any of the components.

Motor

ATTENTION

1. Before use, make sure that the propeller and protective cover are not damaged or cracked, and carefully remove any sand or debris.

⚠ WARNING

1. Do not remove the propeller guard.
2. Do not attempt to fix or touch the propeller in the water.
3. When the system is powered on, keep the propeller away from your body, fingers, and toes.
4. The rotating propeller may cause serious, or even life-threatening, injury. Treat with caution.

Support Rod

ATTENTION

1. The use of the product requires a water depth of at least 1.2 meters. Be careful of gravel, plants, or wild animals in the water.
2. When using the product, pay attention to the surrounding environment, stay away from the shore, and keep a safe distance from ships and others.

⚠ WARNING

1. When used in water, any contact with the wings and the Support Rod may cause serious, or even life-threatening, injury. Treat with caution.

PowerFlight Battery

⚠ WARNING

1. Do not disassemble or modify the PowerFlight Battery for other purposes. Otherwise, the warranty will be invalid.
2. Do not disassemble, puncture, impact, or drop the PowerFlight Battery.
3. Do not operate the PowerFlight Battery with wet hands.
4. Do not install or remove the PowerFlight Battery in water.
5. Do not discard the PowerFlight Battery randomly.
6. Do not expose the PowerFlight Battery to direct sunlight, fire, or place it in an environment where the temperature exceeds 60° C (140° F).
7. Use the standard charger for charging.
8. Place the PowerFlight Battery in a safe place and avoid contact with young children or animals.
9. Check whether the PowerFlight Battery is normal before use. Using abnormal batteries may cause damage, electric shock, fire, and even life-threatening situations.
10. If you need to store the PowerFlight Battery for more than one month, maintain the battery level at 40-60%.
11. The transportation of the PowerFlight Battery needs to comply with relevant local laws and regulations.

4. Restrictions and Local Regulations

It is prohibited to use this product in waters where there are swimmers or divers. It is forbidden to operate in restricted traffic areas. Make sure to strictly abide by local laws and regulations.

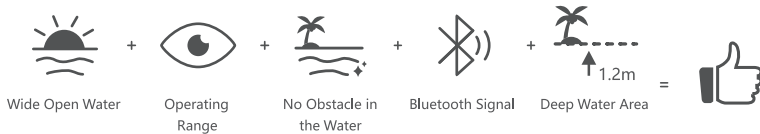

EN

EN

5. After Use

1. After use, press and hold the Power Button of the Controller Plus for 5 seconds, and power off the Controller Plus.
2. Take the board out of the water. Short press the Power Button of the PowerFlight Battery and then long press for 2 seconds. The PowerFlight Battery will beep to confirm it is powered off. Unscrew the Rotary Locks and remove the PowerFlight Battery.
3. Unscrew the Front Wing and Stabilizer Wing fixing bolts and remove the wings.
4. Unscrew the L-shaped fixing bolts to uninstall the plus kit.
5. Rinse off the sand and dirt from the Board and other parts with fresh water.

Troubleshooting

If there are any problems during use, stop operating the product, lay on the board, and paddle with your hands until you return to land. After the problem is solved, you can use the board again. If there is any problem that cannot be solved, contact the after-sales service in time.

Possible Failures and Solutions

1. The battery fault light turns red: Check if the temperature of the battery is too high. If the temperature is too high, stop using it and wait for the battery to cool down before continuing use. Check whether the battery level is too low. If the battery is too low, charge immediately. If the problem is still not solved, contact after-sales service in time.
2. The battery has no output: Check whether the plus power kit and the battery are properly connected. If there is any looseness, tighten the L-shaped bolts in time. Normally, the battery has output. The output indicator on the display will continue to light up in blue.
3. The battery cannot be charged normally: First, check whether the fault indicator of the battery is on. If it is, contact the after-sales service to repair or replace the battery, Next, check whether the charger indicator is flashing red. If the charger is in good condition, check whether the AC plug of the charger and the DC battery port are properly connected. Tighten if they are loose. If the connection is normal, turn the charger over. Make sure the rocker switch of the electrical appliance is in the ON position and then the battery should be able to charge normally.
4. The motor keeps making abnormal noises during use: Immediately release the trigger of the remote control to stop the motor, turn off the remote control, lay on the board, and paddle back to land using your hands. Take out the battery and check whether there is any foreign matter in the propeller. If there is foreign matter, remove the propeller protective cover and the propeller for cleaning. Before inspecting the propeller, make sure that the battery is disconnected and remove the battery.

5. The motor stops rotating during use:

Immediately release the trigger of the remote control to stop the motor, turn off the remote control, and lay on the board and paddle back to land using your hands. Check whether the status indicator of the remote control shows normal connection status. Next, check whether the battery level is normal, and then check whether the plus power kit and the board are loose. If it is loose, tighten it in time. If the problem is not solved after attempting the above steps, remove the battery and check whether sea water has seeped into the metal joints or if there is any corrosion. If the above situation has occurred, rinse the plug with fresh water and dry it with a rust remover to remove the rust on the metal joints. Finally, wash and dry the plug.

6. The machine shakes, vibrates, and it is difficult to maintain balance during use:

Immediately release the trigger of the remote control to stop the motor, turn off the remote control, lay on the board, and paddle back to land using your hands. Remove the battery and check whether the mounting bolts of the plus power kit are loose. If loose, tighten them in time.

7. The remote control connection appears intermittent during use: Immediately release the trigger of the remote control to stop the motor, turn off the remote control, lay on the board, and paddle back to land using your hands. Turn on the remote control and check whether the Bluetooth icon is flashing. If it is flashing, restart the battery and pair again using Bluetooth. If the problem is still not resolved, contact after-sales service in time.

8. The remote controller has a fault: "Err.1" = Angle sensor initialization failed. "Err. 2" Spiash initialization failed. "Err. 3" = Angle sensor and spiash initialization failed. "Err. 4" = GPS failed. "Err. 7" = Angle sensor initialization, spiash initialization, and GPS failed.

EN

Waydoo Flyer ONE Plus – Warranty Period

Board	1 year
Explorer/Patroller PLUS Power Kit	1 year
Front Wing and Stabilizer Wing	6 months
PowerFlight Battery	1 year (or less than 300 cycles)
Controller Plus	1 year
Waydoo Lithium Battery Charger	1 year

EN

After-sales Service Plan

1. When contacting Waydoo, explain in detail the problem with the product.
2. Waydoo's technical support staff will try to diagnose and solve your problem by phone, email, or remote assistance.
3. If you still cannot solve your problem, send the product to Waydoo for further testing. Waydoo will arrange services for you according to the corresponding warranty service type of the product.

Non-after-sales Coverage

- 1). Damage caused by transportation or loading and unloading during the return, exchange, and repair.
- 2). Any unauthorized modification, disassembly, opening, and repair without official authorization.
- 3). Battery damage caused by any accidental factors or human factors, such as obvious hard object damage, cracks, severe deformation, broken power cord, disconnection, etc.
- 4). Product failure or damage caused by installation, use, maintenance, and storage not in accordance with the requirements of the instruction manual.
- 5). Damage due to circuit modification, battery pack modification, or using unmatched chargers guided by unofficial instructions.
- 6). Damage caused by using outside the safe load range of the product.
- 7). Damage caused by forced use of the product when the parts are damaged.
- 8). Damage caused by using batteries with quality problems.
- 9). The product or component has the identification label changed or removed.
- 10). Failure or damage caused by force majeure (such as fire, earthquake, flood, etc).
- 11). Products or parts that have exceeded the warranty period.

FCC Caution:

This device complies with part 15 of the FCC Rules. Operation is subject to the following two conditions:

(1) This device may not cause harmful interference, and (2) this device must accept any interference received, including interference that may cause undesired operation.

Any changes or modifications not expressly approved by the party responsible for compliance could void the user's authority to operate the equipment.

NOTE: This equipment has been tested and found to comply with the limits for a Class B digital device, pursuant to Part 15 of the FCC Rules. These limits are designed to provide reasonable protection against harmful interference in a residential installation. This equipment generates, uses and can radiate radio frequency energy and, if not installed and used in accordance with the instructions, may cause harmful interference to radio communications. However, there is no guarantee that interference will not occur in a particular installation.

If this equipment does cause harmful interference to radio or television reception, which can be determined by turning the equipment off and on, the user is encouraged to try to correct the interference by one or more of the following measures:

- Reorient or relocate the receiving antenna.
- Increase the separation between the equipment and receiver.
- Connect the equipment into an outlet on a circuit different from that to which the receiver is connected.
- Consult the dealer or an experienced radio/TV technician for help.

The device has been evaluated to meet general RF exposure requirement. The device can be used in portable exposure condition without restriction.

FCC ID: 2ATT4-WA