

Tempo™

WALK



OWNERS MANUAL

Club Car

To find your local authorized Club Car dealer,
visit www.clubcardealer.com, or call 1-800-ClubCar (258-2227)

FCC Notice (for U.S. Customers):

*This device complies with Part 15 of the FCC Rules:
Operation is subject to the following conditions:*

- 1. This device may not cause harmful interference, and*
- 2. This device must accept any interference received, Including interference that may cause undesired operation*

Changes and Modifications not expressly approved by Club Car can void your authority to operate this equipment under Federal Communications Commissions rules.

RADIO AND TELEVISION INTERFERENCE

This equipment has been tested and found to comply with the limits for a Class B digital device, pursuant to Part 15 of the FCC rules. These limits are designed to provide reasonable protection against harmful interference in a residential installation. This equipment generates, uses and can radiate radio frequency energy and, if not installed and used in accordance with the instructions, may cause harmful interference to radio communications. However, there is no guarantee that interference will not occur in a particular installation. If this equipment does cause harmful interference to radio or television reception, which can be determined by turning the equipment off and on, the user is encouraged to try to correct the interference by one or more of the following measures:

- Reorient or relocate the receiving antenna.*
- Increase the separation between the equipment and the receiver.*
- Connect the equipment into an outlet on a circuit different from that to which the receiver is connected.*
- Consult the dealer or an experienced radio/TV technician for help.*

You may also find helpful the following booklet, prepared by the FCC: "How to Identify and Resolve Radio-TV Interference Problems." This booklet is available from the U.S. Government Printing Office, Washington D.C. 20402.]

ISED Canada Notice (for Canada Customers):

This device complies with Industry Canada licence-exempt RSS standard(s). Operation is subject to the following two conditions: (1) this device may not cause interference, and (2) this device must accept any interference, including interference that may cause undesired operation of the device.

Le présent appareil est conforme aux CNR d'Industrie Canada applicables aux appareils radio exempts de licence. L'exploitation est autorisée aux deux conditions suivantes: (1) l'appareil ne doit pas produire de brouillage, et (2) l'utilisateur de l'appareil doit accepter tout brouillage radioélectrique subi, même si le brouillage est susceptible d'en compromettre le fonctionnement.

NOTICE

Warranty information appears at the end of this manual. No other warranties, expressed or implied, are contained herein. Your authorized representative checked the unit before it was delivered to you and will provide you a copy of the completed unit warranty registration form.

Club Car is not liable for errors in this manual or for incidental or consequential damages that result from the use of the material in this manual.

This manual contains proprietary information that is protected by copyright. All rights are reserved. No part of this manual may be photocopied, reproduced, or translated to another language without the written consent of Club Car, LLC.

The information contained in this document is subject to change without notice.

Club Car reserves the right to make design changes to units without obligation to make these changes on units previously sold.

If in English, this manual is the Original Instructions provided by the manufacturer. If in any language other than English, this manual is a translation of the Original Instructions.

P.O. Box 204658 Augusta, Georgia 30917-4658 USA Telephone 706-863-3000 Service Parts Fax 706-855-7413 www.clubcar.com

Copyright © 2018, Club Car, LLC Club Car, Tempo Walk is a registered trademark of Club Car, LLC.

FOREWORD

Thank you for choosing Club Car, the name most widely recognized as the industry leader in unit efficiency and long-lasting value. You have chosen the finest walking cart on the market. Please protect your investment and ensure that your Tempo Walk provides years of reliable, superior performance by reading and following the maintenance instructions in this manual.

Your comfort and safety are important to us, so we urge you to read and follow the step-by-step operating instructions and safety precautions in this manual. These instructions must be followed in order to avoid the risk of severe personal injury. If you rent or loan your unit to others, we recommend that you ask them to read this manual before they operate Tempo Walk.

Club Car products are backed by a customer support system designed to offer you fast, courteous service. In the event that your cart needs repairs or service, please contact your local authorized Club Car dealer or distributor, who will be able to provide technical advice, perform warranty work, and sell parts and service manuals.

To find your local authorized Club Car dealer, visit www.clubcarddealer.com, or call 1-800-ClubCar (258-2227).

If you would prefer to write to us, direct your letter to: Club Car LLC, Attention: Marketing Services, P.O. Box 204658, Augusta, Georgia 30917-4658 USA.

We hope you will consider this owner's manual a permanent part of your cart.

Additional Product Resources

We have created a Tempo Walk Video Library to assist you in the following areas: New User Training, Course Set Up, Product Knowledge, Repair and Maintenance, and Diagnostics. You can easily access this information at www.clubcar.com/tempowalkresources

TABLE OF CONTENTS

TECHNICAL PUBLICATION CUSTOMER SATISFACTION ONLINE SURVEY	3
TEMPO WALK OVERVIEW	3
MAINTENANCE ITEMS	3
SAFETY DECAL AND FEATURE IDENTIFICATION	4
PRACTICE SAFETY	5
SAFETY DETAILS	5
GENERAL WARNINGS	6
PROPOSITION 65 – STATE OF CALIFORNIA	7
RECYCLING LITHIUM ION PHOSPHATE BATTERIES	7
GENERAL INFORMATION	8
MODEL IDENTIFICATION	8
SAFETY COMMITTEE	8
CONTROLS AND INDICATORS	9
PRE-OPERATION AND DAILY SAFETY CHECKLIST	10
PERFORMANCE INSPECTION	10
STARTING AND OPERATING TEMPO WALK	11
STOPPING TEMPO WALK	12
TEMPO WALK TRANSMITTER	13
REPLACING A TOGGLE SWITCH	14
CHANGING CHANNELS ON TEMPO WALK	14
CALIBRATING A TEMPO WALK	16
OBSTACLE SENSOR SYSTEM	17
TEMPO WALK TABLET Samsung Galaxy Tab 8.0 (Verizon)	18
TOWING	21
LONG TERM STORAGE	21
MAINTENANCE	23
PERIODIC SERVICE SCHEDULES	23
PERIODIC LUBRICATION SCHEDULES	25
BATTERY	25
BATTERY CHARGER	31
CHARGING PROCEDURES	35
CHARGING BATTERY	35
CLEANING THE UNIT	37
ACCESSORIES	37
SUBSEQUENT OWNER REGISTRATION	37
TEMPO WALK SPECIFICATIONS	38
TEMPO WALK LIMITED WARRANTY:	41
MOST FREQUENT WARRANTY WORK	44

TECHNICAL PUBLICATION CUSTOMER SATISFACTION ONLINE SURVEY

Let your voice be heard!

Please participate in the Technical Publication customer satisfaction online survey. This survey takes less than five minutes to complete and your responses will help examine current performance and identify areas for future improvement.

Our top priority is to provide timely, accurate, and user-friendly manuals.

The online survey can be found at: <http://bit.ly/1w9uFMh>.

TEMPO WALK OVERVIEW

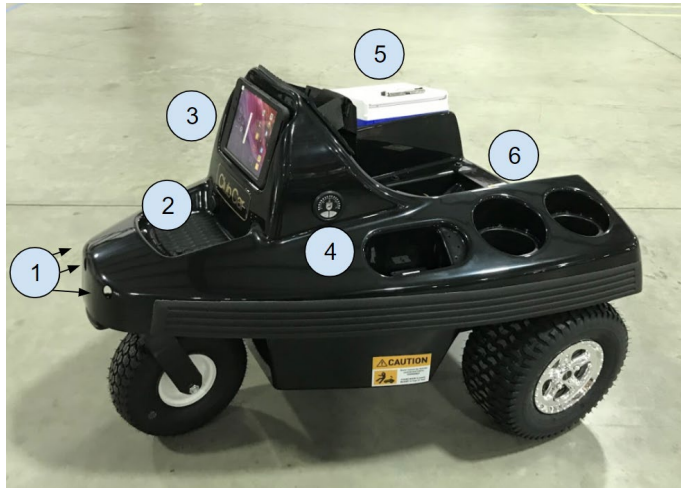

1	47640674001	Ultrasonic Sensors (3 qty) - Obstacle Detection
2	47640671001	Dual USB Charge Ports - Charging cell phones
3	47642670001	8" Tablet - Front, Center, & Back Yardages
4	47640665001	Dashboard - Power, Run, Neutral, & Battery Meter
5	47642475001	Cooler with Scorecard Clip
6	Included	Cup Holders - Divot Repair Seed and Beverages (not included)

MAINTENANCE ITEMS

⚠ WARNING

- Read before attempting any service on the unit.
- Before servicing unit, read complete section(s) and any referenced information that may be relevant to the service or repair to be performed.

MAINTENANCE ITEMS	
Motor - Gear Lube Valvoline Multi Purpose #2 Grade Lithium Complex	Fuse, 30 Amp CC P/N 102492301
Front Caster - Grease Valvoline Multi Purpose #2 Grade Lithium Complex	Dashboard - Silicone GE Clear 100% Waterproof Silicone 2+*
Rear Tires: Max PSI 14 Kenda "Turf Rider" 13x6.5x6 Tubeless 2 ply	Front Tire: Max. PSI 22 Kenda "Turf Rider" 11x4.0x4 Tubeless 2 ply

Figure 1 Maintenance Items

SAFETY DECAL AND FEATURE IDENTIFICATION

The following pages contain safety decal and feature identification information. For detailed information on specific features, read the appropriate section in this manual.

TEMPO WALK



1	47642670001	Operating Instructions on tablet start screen
2	47634800001	Decal, Warning- Do not ride on Tempo Walk
3	47664051001	Decal, Caution - Tempo Walk moves by remote control
4	47640665001	Dashboard, Battery Power Meter - Shows battery level Dashboard, Power Button - powers on and off the Tempo Walk Dashboard, Run/Neutral Button - changes operation mode

PRACTICE SAFETY



Figure 2 Practice Safety

Safety signs like you see above may at first seem shocking, but their impact is mild compared with the reality of severe personal injury.

Your safety and satisfaction are of the utmost importance to us. That is why before operating Tempo Walk, we urge you to review the information in this manual. Understand and become familiar with the DANGER, WARNING, and CAUTION statements and procedures it contains, along with the safety decals that are affixed to your unit.

Take time to understand the language of safety. It is a language that can save your life.

SAFETY DETAILS

⚠ WARNING

- **This owner's manual should be read completely before attempting to use or service the unit. Failure to follow the instructions in this manual could result in property damage, severe personal injury, or death.**

It is important to note that some vital statements throughout this manual and on the decals affixed to the unit are preceded by the words DANGER, WARNING, or CAUTION. For your protection, we recommend that you take special notice of these safety precautions. Safety precautions are essential and must be followed.

Throughout this manual and on the operation and safety decals affixed to the unit, the words "cart" and "unit" are used interchangeably.

If any of the operation or safety decals on the unit become damaged, have been removed or cannot be easily read, they should be replaced immediately to avoid possible property damage, personal injury, or death. Contact your distributor/dealer.

⚠ DANGER

- **A DANGER indicates an immediate hazard that will result in severe personal injury or death.**

⚠ WARNING

- **A WARNING indicates an immediate hazard that could result in severe personal injury or death.**

CAUTION

- A CAUTION symbol indicates a hazard or unsafe practice that could result in personal injury.

GENERAL WARNINGS

The following safety statements must be heeded whenever the unit is being operated, repaired, or serviced. Unit feature identification information is also included. See Safety Decal and Feature Identification on page 5. Other specific safety statements appear throughout this manual and on the unit.

⚠ DANGER

- **Battery – Explosive gases! Do not smoke. Keep sparks and flames away from the unit and service area. Ventilate when charging or operating unit in an enclosed area.**
- **The unit will not provide protection from lightning, flying objects, or other storm-related hazards. If caught in a storm while using Tempo Walk, turn off and remove the transmitter from your person, turn off the power to the unit, and seek shelter in accordance with applicable safety guidelines for your location.**

⚠ WARNING

- Follow the procedures exactly as stated in this manual, and heed all DANGER, WARNING, and CAUTION statements in this manual as well as those on the unit and battery charger.
- Do not leave children unattended near Tempo Walk.
- Prior to leaving the unit for extended periods, or servicing the unit, turn off the power to the unit, and disconnect the main power fuse under the cooler. Chock the wheels when servicing the unit.
- Improper use of the unit or failure to properly maintain it could result in decreased performance, severe personal injury, or death.
- Any modification or change to Tempo Walk that affects the electrical system, stability or tracking of the cart, or increases maximum speed settings beyond factory specifications, could result in severe personal injury or death.
- Check the cart for proper location of all unit safety decals and make sure the operating instructions are in place and are easy to read on the tablet. See Safety Decal and Feature Identification on page 5.
- Only trained technicians should service or repair the unit or battery charger. Anyone doing even simple repairs or service should have knowledge and experience in electrical and mechanical repair. The appropriate instructions must be used when performing maintenance, service, or accessory installation.
- Wear safety glasses or approved eye protection when servicing the unit or battery charger.
- Do not wear loose clothing or jewelry such as rings, watches, chains, etc., when servicing the unit or battery charger.
- Use insulated tools when working near batteries or electrical connections. Use extreme caution to avoid shorting of components or wiring.

PROPOSITION 65 – STATE OF CALIFORNIA

⚠ WARNING

- This product can expose you to chemicals including Nickel and Carbon which are known to the state of California to cause cancer and birth defects or other reproductive harm. For more information, go to www.P65Warnings.ca.gov.

RECYCLING LITHIUM ION PHOSPHATE BATTERIES

⚠ WARNING

- Lithium Ion Phosphate batteries contain lithium, carbon, and other metals, acids and compounds. If improperly handled, they can contaminate both water and soil, causing environmental damage and personal injury.

Lithium Ion batteries should be properly recycled (Figure 3). They cannot be disposed as municipal waste and must be collected separately. Responsibility for environmental protection must be shared, not only by the manufacturers of the batteries, but by people who use the batteries as well. Please contact your nearest Club Car dealer or distributor for information on how to properly recycle your batteries.

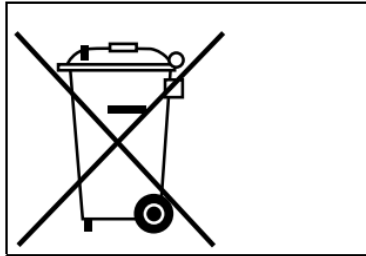

Figure 3 Dispose of Lithium Ion Batteries Properly

INTERNATIONAL SAFETY SYMBOLS ON BATTERIES Anyone using, repairing, or servicing the unit must understand and heed the safety symbols on the unit battery or batteries.

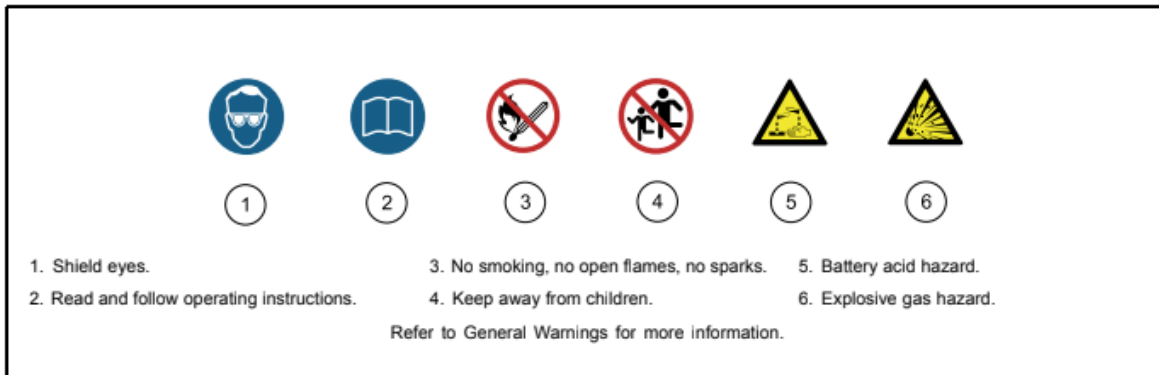

Figure 4 International Safety Symbols on Batteries

GENERAL INFORMATION

We urge the Tempo Walk owner/operator to read and understand this manual, and to pay special attention to the safety issues specific to this cart.

MODEL IDENTIFICATION

The serial number of each cart is printed on a metal emblem located on the frame under the cooler (Figure 5). This serial number is an alphanumeric code (Example: to AV1906-001300) (Figure 6).



Figure 5 Serial Number Location (under cooler)



Figure 6 Serial Number Plate

SAFETY COMMITTEE

If the Tempo Walk cart is to be rented or is part of a fleet, we strongly recommend that a safety committee be appointed. One of the main concerns of this committee should be the safe operation of the carts. This should include at a minimum:

- Where carts should be operated, proper safety and directional signage, and installing ramps where needed
- Ensuring that proper warnings/hazards are displayed and visible on the unit.
- Who should and who should not use the carts.
- Instructing first time users on safe and proper use, and ensuring they watch the tutorial video
- Maintaining carts in a safe condition.
- What to do if a user needs support.
- How various rules are to be enforced.
- The safety committee should include all these items and such others as the committee feels necessary or appropriate.



CONTROLS AND INDICATORS

See General Warnings on page 7.

⚠ WARNING

- If renting or loaning the unit, make sure the operator is familiar with all controls and operating procedures before allowing the cart to be used.
- Do not turn towards the unit when the unit is connected to the transmitter.
- Always bring the cart to a full stop before turning off the transmitter.
- When Tempo Walk is in the neutral position, the unit has no brakes and will not connect to the transmitter.
- Always put the unit back into the run position to operate with the transmitter.
- The transmitter will immediately stop the unit if its power switch is turned off (see figure 8)

The dashboard is located on the driver side of Tempo Walk, push the power button to turn the unit off and on, see (Figure 7) you will hear a brief chime when the cart turns on. The unit is in “neutral” when the blue LED light is lit, and is in the “run” position when the LED light is not lit.

	
<p>Figure 7 Dashboard (On/Off/Neutral)</p>	<p>Figure 8 Transmitter Toggle Switch (On/Off)</p>

Battery Low State-of-Charge Warning

- When the LED lights on the dashboard are red, the unit must be recharged.
- When the unit is turned on, if you hear the voice audio, “Low Battery”, the unit should not be used and must be recharged.

CAUTION

- When the LED lights indicate a low state of charge, the unit should be placed on a charge as soon as possible.

USB Charge Port for Cell Phone Charging

The 5-volt 2.4-amp outlet (Figure 9) provides electricity to power and recharge portable devices. The USB port is not designed for the transfer of data.



Figure 9 USB Port

PRE-OPERATION AND DAILY SAFETY CHECKLIST

Each Club Car unit has been thoroughly inspected and adjusted at the factory; however, upon receiving your new unit(s), you should become familiar with its controls, indicators, and operation. Carefully inspect each unit to ensure that it is in proper working condition before accepting delivery.

Use the following checklist as a guide to inspect the unit. This checklist should be used daily to ensure that the unit is in proper working condition and in conjunction with the Performance Inspection on page 11, and the Periodic Service Schedules on page 19. Any problems should be corrected by a Club Car distributor/dealer or a trained technician.

Any unit not functioning correctly should be removed from use until it is properly repaired. This will prevent further damage to the unit and avoid the possibility of injury due to unsafe conditions.

- General: All the parts should be in place and properly installed. Be sure that all nuts, bolts, and screws are tight.
- Safety and information decals: Check to ensure that all safety and information decals are in place. See Safety Decal and Feature Identification on page 5.
- Tires: Visually inspect tires for wear, damage, and proper inflation on a daily basis. See unit Tempo Walk Specifications on page 32.
- Charger cord, plug, and receptacle: Visually inspect for cracks, loose connections, and frayed wiring. See Plug and Receptacle on page 27.

PERFORMANCE INSPECTION

After you have familiarized yourself with the Tempo Walk's controls, have read and understood the operating instructions, and have watched the tutorial video, then take the unit out for a test walk.

Use the following checklist in conjunction with the Daily Pre-Operation and Safety Checklist as a guide to inspect the unit and check daily for proper operation. Any problems should be corrected by a Club Car distributor/dealer or a trained technician.

- Brakes: Be sure to check that both rear motor brakes function properly. When the unit is turned off, the brakes should hold Tempo Walk firmly in place on both sides of the unit. If the unit is powered on, and is in the "Run" position, both brakes should also hold the unit firmly in place. If the unit is placed in the "neutral" position, it should roll freely by hand. If the unit fails to exhibit these conditions have the motor brakes checked and adjusted as required.

- Tracking: The unit should be tracking centered on the transmitter and should have only minor play due to terrain and golfer movement. The unit should follow approximately 4 feet behind the transmitter.
- General: Listen for any unusual noises such as squeaks or rattles. Check the unit's performance. Have a Club Car distributor/dealer or a trained technician investigate anything unusual.
 - Note: Front Caster may oscillate slightly when being moved without a golf bag and clubs
- Acceleration: when the unit is connected to the transmitter, it should smoothly pick up speed as the golfer accelerates their walking pace. It should slow down when the golfer slows their pace.
- Walk Away: The unit will apply brakes, when the transmitter gets more than 12' away from the unit.
- Turning: When connected to the transmitter, the unit should turn, following the direction of the golfer. Should the golfer rotate their body too far when making sharp turns, the unit may shut itself off.
- Should objects interfere with the front sensors, the unit brakes will be immediately deployed, and a voice audio will inform the user that the front sensors have been activated.

⚠ WARNING

Once the front sensors are tripped, the unit will put the sensors on hold for 30 seconds to give the user time to free themselves from their situation, then the front sensors will be reset.

⚠ WARNING

- Slopes: Always walk the unit directly up and down the "Fall" line of slopes. Do not operate along steep side hills. Do not operate unit on slopes exceeding 10% grades.

STARTING AND OPERATING TEMPO WALK

1. Study and understand all controls.
2. Read safety and information decals located on the unit and view the tutorial video
3. Securely fasten clubs in Tempo Walk.
4. Make sure front wheel is turned in desired direction.
5. Turn the unit ON by pressing the power switch on the dashboard and make sure nothing is in your path. Make sure the unit is not in the neutral position.
6. Make sure transmitter switch is "OFF", then attach transmitter securely and vertically on your waistband at the center of your back. Never use the transmitter in any other position.
7. When ready to activate Tempo Walk make sure you are in a safe operating environment. Once the transmitter is directly facing the unit, turn the transmitter switch to the "ON" position, which will be in the up position on the toggle switch. Standing centered and directly in front of the unit approximately 2-3 feet, SLOWLY begin to walk away from the unit until you hear a "beep" indicating that you are now connected to Tempo Walk. Tempo Walk is now following you, and it will maintain an operating distance of 2 to 6 feet.

⚠ WARNING

- The Operator is taking full responsibility and control of all movement of the Tempo Walk.
- Make safety your top priority
- Keep the transmitter facing the Tempo Walk unit at all times.
- Walk in the center of cart paths and bridges
- When 2 or more Tempo walk units are operating, walk in single file on cart paths
- Keep front sensors clear of obstacles (i.e. towels, head covers, etc.)

- The unit will stop following you when the transmitter is turned off
- Bring unit to a complete stop before turning off the transmitter
- Turn off transmitter when approaching greens and tee boxes
- Take wide turns and leave extra room when navigating obstacles. Always maintain a 3-foot clearance from any objects or obstacles.
- Never let Tempo Walk, follow you into woods, hazards, standing water (> 5 inches), on greens, or tee boxes.
- Use extra caution operating Tempo Walk near water, on hills, and in confined spaces (i.e. bridges, walkways).
- To prevent Tempo Walk from following you, you must deactivate Tempo Walk by turning the transmitter “OFF”, which will mean the transmitter toggle switch will be in the down position.
- To move Tempo Walk in reverse, ensure Tempo Walk is connected and SLOWLY back toward it, or turn transmitter off, put unit in neutral and manually roll the unit backwards as desired.
- Should Tempo Walk fail to respond to transmitter signals. Have a Club Car distributor/dealer or a trained technician investigate anything unusual.
- Never tilt, flip, tip, lift or attempt to service Tempo Walk

STOPPING TEMPO WALK

⚠ WARNING

- Walking through shallow water (< 5 inches) may affect the brakes and the electronics. After walking through water, check effectiveness of the brakes by turning the transmitter “OFF” and checking to see that the unit is held firmly in place.

PARKING AND LEAVING THE TEMPO WALK

1. After coming to a complete stop, turn off the transmitter. This disconnects you from Tempo Walk.
2. Turn the unit power off by pressing the power switch on the dashboard.
3. Remove the transmitter from your waist and place it on the unit.

⚠ WARNING

- Only licensed drivers should be allowed to operate the unit.
- If renting or loaning the unit, make sure the operator is familiar with all controls and operating procedures, and has watched the tutorial video, before allowing the unit to be taken.
- Do not allow a passenger to ride on the unit. This product has a 50 lb. payload capacity
- The unit is not specially equipped for handicapped persons. Be sure all persons can properly operate the unit prior to allowing them to take the unit.
- For day use only.
- To help avoid being struck, do not stand close to the unit.
- Do not leave children unattended near the unit.
- To help prevent overturning the unit, walk straight (i.e. the fall line) up and down slopes. Avoid operating the unit on slopes exceeding a 10% grade.
- Avoid sudden starts, sudden stops, and abrupt turns.

- To help avoid the possibility of losing control of the unit, reduce speed for adverse conditions such as wet grass or rough terrain.
- Obey all local rules concerning golf cars.
- The unit should be operated in only specified areas by trained users.
- Do not operate while under the influence of alcohol, drugs, or medications.
- Never operate Tempo Walk in dangerous weather conditions.
- This unit is not intended to be used where risk of falling objects exists. If your unit will be used in such an environment, contact your local dealer.

No one should operate the unit without first being instructed in the proper operation and use of the unit's controls. An experienced operator should accompany each first-time user on a test drive before allowing him/her to operate the unit alone.

TEMPO WALK TRANSMITTER

⚠ WARNING

- Submerging the transmitter in water will affect the performance of the internal electronics of transmitter. After submerging in water, contact your local Club Car distributor/dealer immediately.
- The transmitter should be charged daily. If the green light on the front of the transmitter is Flashing, it means the transmitter needs to be charged as soon as possible. If the green light is solid, the transmitter has sufficient charge level. See (Figure 16) for proper transmitter charging procedures
- If the transmitter is dropped or takes a significant impact, it may affect the performance of the transmitter. Should this occur, check the operations by attempting to connect to the Tempo Walk unit. If the transmitter doesn't perform normally contact your local Club Car distributor/dealer for a replacement.
- Never operate the Tempo Walk unit with the transmitter in any position other than secured on your waist at the middle of your back. The transmitter should always provide a clear signal to Tempo Walk by being pointed at the unit. Attempting to hold the unit in your hand, placing it in a pocket or putting the transmitter anywhere other than on your waist is an unsafe practice.

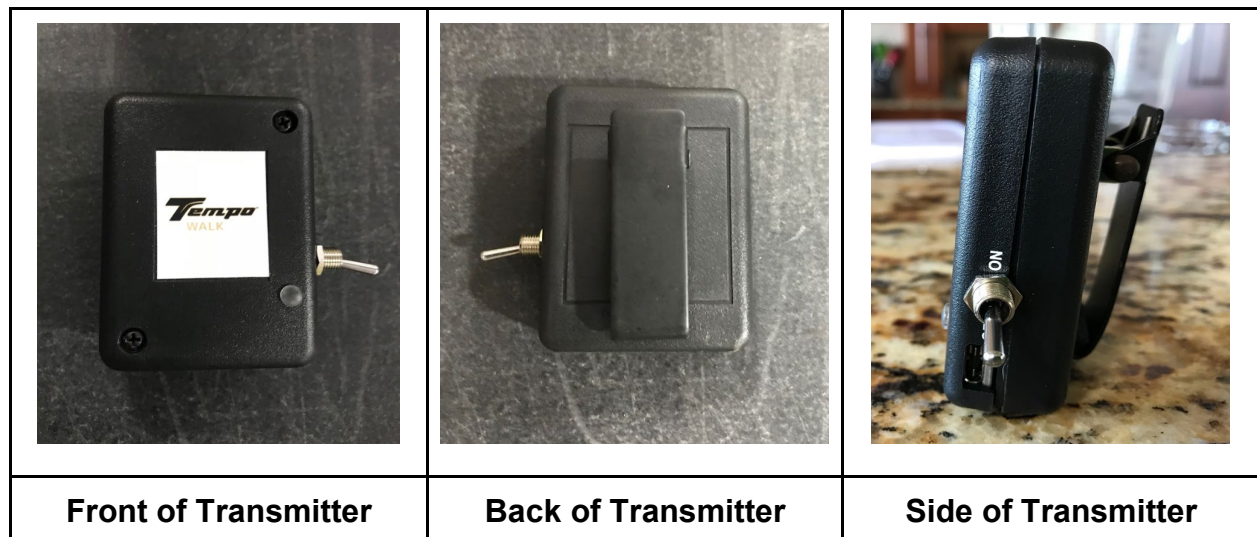

REPLACING A TOGGLE SWITCH

The most common maintenance item on the transmitter is a broken toggle switch. Replacement is easy

- 1) Make sure the transmitter is turned off.
- 2) Loosen the nut securing the toggle switch at the side of the transmitter case.
- 3) Remove the 2 screws on the front lid of the case.
- 4) Gently remove the transmitter case lid.
- 5) Gently unplug the white toggle switch connector from the Transmitter board see figure 10.
- 6) Plug in a new toggle switch to the transmitter board. Make sure the toggle switch is oriented so that the "On" position will be up when the case lid is reattached.
- 7) Repeat steps 2-4 in reverse order to close and secure the transmitter case.

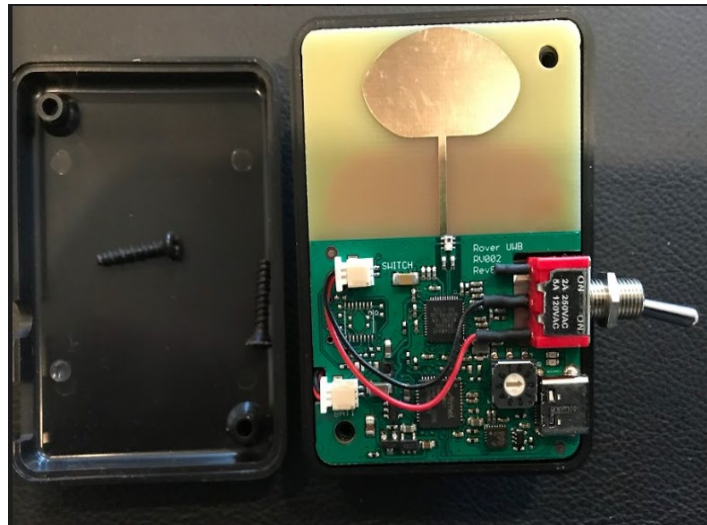

Figure 10 Opened Transmitter

CHANGING CHANNELS ON TEMPO WALK

⚠ DANGER

- Never have 2 or more Tempo Walk units with the same channel turned on, in the same proximity (i.e. 500 Yards).
- Never have 2 or more Tempo Walk Transmitters with the same channel turned on, in the same proximity (i.e. 500 Yards)

⚠ WARNING

Make sure all units in the immediate area are turned off as well as all transmitters

Changing the channel of a Tempo Walk unit requires two steps. First you must set the channel on the Tempo Walk transmitter, and second you must set the channel on the unit itself. These channels must be the same for the unit to operate properly

Setting the channel on the Transmitter

1. Make sure the transmitter is turned off.
2. Loosen the nut securing the toggle switch at the side of the transmitter case.
3. Remove the 2 screws (#1 Phillips) on the front lid of the case.
4. Gently remove the transmitter case lid.
5. Channels are selected using the white rotary dial on the transmitter board (see fig. 10B set to ch 2)
6. Use a small flat head screwdriver and turn the dial so that the arrow points to the desired channel
7. Make sure this channel matches the corresponding TW unit channel
8. Repeat steps 2-4 in reverse order to close and secure the transmitter case

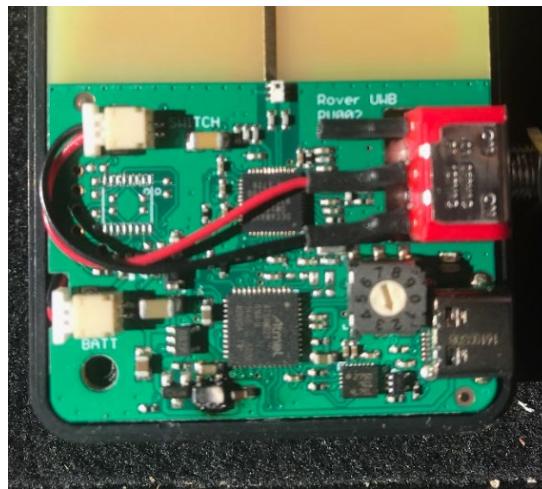

Figure 10B Transmitter Board

Setting the channel on the Tempo Walk Unit

1. Power On the unit using the dashboard
2. Press the neutral button steadily until you hear the voice audio "Calibration Mode", continue to press the neutral button until you hear the audio "Channel Select Mode". You are now ready to reset the channel.
3. At this point the battery meter LED lights will go away and illuminate only one light indicating the current channel of operations for the unit (see fig 12) (note: Channel zero is set to LED light #10)
4. Push the neutral button until the LED light shows the desired channel (i.e. LED light #5 would be set to channel #5)
5. Pause and wait to hear the chime indicating the channel is reset and then the battery meter will light up fully

It is recommended that you calibrate the unit once you change its channel

CALIBRATING A TEMPO WALK

Calibrating the Tempo Walk allows the unit to travel centered on the golfer and at the appropriate following distance (48”).

1. **Always calibrate the unit on a flat and level surface.**
2. Place a tape measure extending straight from the front nose of the unit for 48” (see table below). Make sure the tape is centered on the unit (see table below).
3. Power on the unit and press the neutral button steadily until you hear the voice audio “Calibration Mode”
4. Quickly move to straddle the measuring tape, with your heels at the 48” mark. Your back should be facing the unit and you must stand still during calibration process.
5. The transmitter should be turned on and it should be centered on your waist in the middle of your back.
6. Wait for the unit to successfully complete its calibration, which will be signaled by several quick chimes. You must wait until these chimes end before you move. It is now ok to turn off the transmitter.
7. Should you hear repetitive gongs it means the calibration was unsuccessful. Possible reasons for this are as follows:
 - a. Transmitter isn’t charged properly (Green light flashing or off)
 - b. Transmitter isn’t turned on during calibration, or the unit is not turned on.
 - c. The Channels between Tempo Walk (abbreviated: TW) and transmitter aren’t the same.
 - d. Make sure no other transmitters or units are ON.
8. Once these conditions are corrected you can repeat steps 1-6 to re-calibrate the unit
9. Test the unit tracking by walking it around to make sure that the Tempo Walk is following correctly, both following distance (48”) and tracking centered on the transmitter.

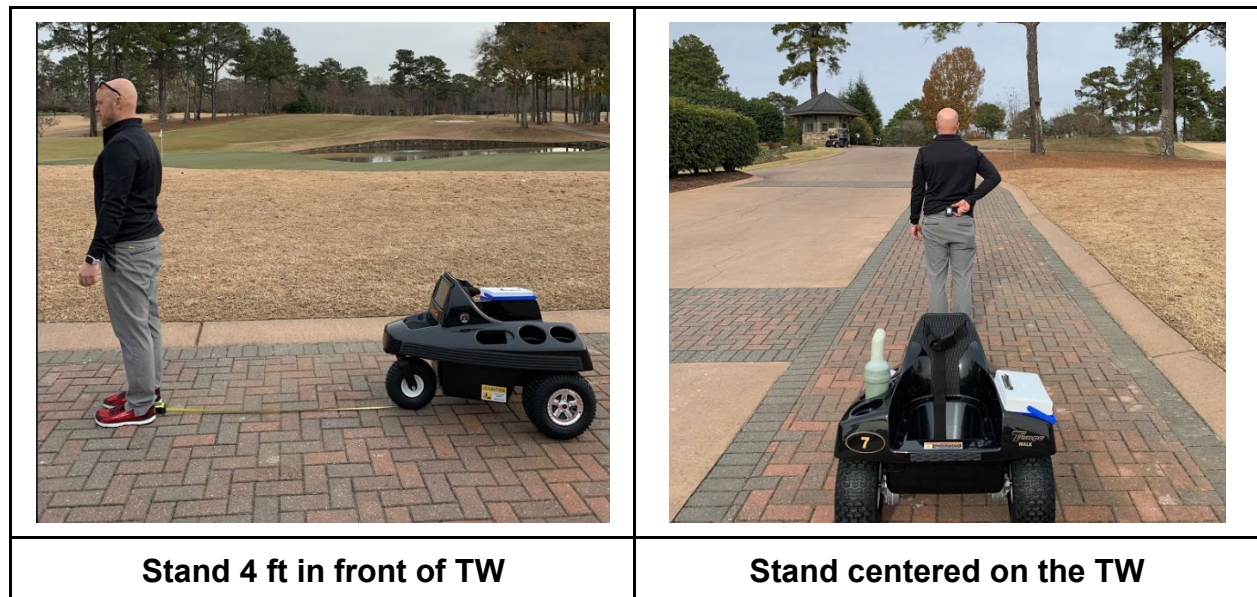

OBSTACLE SENSOR SYSTEM

⚠ DANGER

Never walk in front of the Tempo Walk while it's in operation. The obstacle sensor system is designed to assist the operator in detecting obstacles while using Tempo Walk. The system is equipped with 3 Ultrasonic Sensors (**See Pic on Page 3 – Tempo Walk Overview – 1 - 47640674001 – Ultrasonic Sensors (3 qty) – Obstacle Detection**) which provide obstacle support from the front of the Tempo Walk. Should an obstacle be detected by the sensors, Tempo Walk will immediately disconnect from the transmitter, and apply the brakes.

Note: Once a sensor has been activated, there is a 30 second delay before it is ready for use. This “delay” allows the Tempo Walk operator time to move the unit into a clear space.

DISABLING A SENSOR OR THE ENTIRE SENSOR SYSTEM

Should a sensor be malfunctioning Tempo Walk is equipped with software to disable it, and allow the Golfer to enjoy the rest of their round. If any individual sensor activates 3 times within 30 minutes, that sensor is disabled and will provide no protection. There will be a voice audio letting the operator know which sensor is disabled (i.e. “Left” sensor disabled) Should the entire sensor system activate more than 5 times within 30 minutes the entire system will be disabled.

CAUTION

Once a sensor or the entire sensor system is disabled it will provide no obstacle assistance until the problem is remedied. The operator should exercise extreme caution during this condition.

HOW TO RESET “DISABLED” SENSORS OR SYSTEM

Once the necessary repairs have been made, follow these steps.

Step 1: Turn on the Tempo Walk, and wait for the start-up chime

Step 2: Wait for the audio about the disabled sensors (approx. 5 secs)

Step 3: Press the neutral button “N” twice (Located on the dashboard)

TEMPO WALK TABLET Samsung Galaxy Tab 8.0 (Verizon)

Initial Tablet Setup

1. Power On the Tablet (hold button on top left).
2. Select gear at the top right of operating instructions screen (Password: 6456 - Submit).
3. Select "Location Setup" from left column, and then type in the course name you want to find in the search box. Be patient it may take up to 60 seconds for the file to be located.
4. Select the desired course file that is displayed below the course search field (Hit Save, then ok).
5. Verify that this is done correctly:
6. Select "Exit" tab from the left column when finished.
7. Press the "Start" button and hole selection to confirm tablet has been set up correctly.

***If you cannot locate the course file by name and/or city, reach out to your Club Car representative or search for the course at <https://skydroid.net/courses.php>.*

*If it is not preloaded, Club Car will need to map the course, which may take a couple days. When this is finished follow these instructions on how to download a file via WiFi***

WiFi Download Method

1. Tap the Screen 7x quickly (use multiple fingers)
 - a. **Exit passcode 3897**
 - b. Press the "Stop Kiosk Mode" button (bottom middle)
 - c. Disable Kiosk Mode to confirm.
2. Select the 4x4 white grid icon on the bottom right of the screen. (All Applications)
3. Find and Select the Settings App
 - a. Navigate to the WiFi settings
 - b. **Connect to WiFi or your phone's mobile hotspot**
4. Press Tablet's Home button
5. Select the 4x4 white grid icon on the bottom right of the screen. (All Applications)
6. Find and Select the Fully Single App Kiosk
 - a. Select the "Start Kiosk Mode" button.
 - b. Disable Test Mode then select Yes.
 - c. Select Fully Single App Kiosk and select "Always" for the default launcher
7. Within the Tempo Walk App
 - a. **Navigate to Gear Icon, then enter passcode 6456**
 - b. Select "Location Setup" tab on the left side.
 - i. When the data fields load, scroll to bottom of screen
 - ii. Press the "Download A Course" button
 - iii. Navigate to the correct course
 1. Note: This course will need to be mapped first, so contact Club Car contact to make sure this is completed.
 - iv. Select "Save" button on top of screen
 1. Press OK to confirm
 - c. Select "Exit" tab on the left side (you may need to scroll screen up to see this).

- d. Verify that course file loaded correctly
 - i. Press Start button on Operating Instructions page
 - ii. Select 9/18 holes
 - iii. Verify course name is correct (top left)

How to use the tablet

1. On the Operating Instructions Screen select the TUTORIAL button to watch the training video.
2. On the Operating Instructions Screen select the START button to view course yardages.
3. Optional: For courses with multiple courses or 9's, select the correct course/9 first (highlight in green)
4. Select the desired number of holes to play: 9/18
5. Begin playing your round.
6. **If you do not get within 25 yards of the green, the tablet will not auto advance to the next hole.**
 - a. If this happens just select the Previous or Next buttons to navigate to the correct hole.
7. When you are finished, press the "end round" button.

How to Remove and Replace the tablet

1. Unclip the front plastic screen protector on sides of tablet
2. Push back the rubber gasket around the tablet case edges.
3. Remove the tablet.

Tip: Be gentle when removing the tablet so that the charge cable doesn't get damaged.

4. Plug in the micro USB cable using the right orientation into the new tablet.

Tip: You may need to reach from inside the Tempo Walk to plug in the charger cable securely.

5. Slide the tablet into the case, with the charger side first.
6. Make sure that the tablet is charging (top right of screen)

Tip: The battery icon will have a lightning bolt in it or say 100%.

7. Secure the rubber gasket around the tablet case edges.
8. Replace the plastic screen protector. Tip: Start with the top left tab placement.

Troubleshooting the Tablet

Yardages are not accurate (Note: It can take up to 30 seconds for tablet to show accurate yardage)

1. Check to see if the GPS location icon is on, it looks like an upside-down teardrop (located on the top right of the tablet screen).
 - a. If this is flashing, the tablet is trying to connect to the GPS satellites. Give it a moment.
 - b. If the icon is missing, you may need to reset the tablet so that it can function correctly again.

Simply hold the power button down until the reset option pops up. Then press reset.

Black Screen

1. Check to see if the tablet is powered on by pressing the power button on the top left of the tablet.
 - a. If the screen lights up, swipe your finger up from the bottom of the screen to unlock the tablet and use it as normal.
 - b. If this does not work, look to see if the tablet charge cable is still plugged in.
 - i. Remove the tablet and make sure the cable is snug in the charge port.
 - ii. Note: You may also want to plug the tablet into a wall outlet and charge it up to

make sure the tablet isn't broken.

- iii. **Be careful reattaching the tablet to Tempo Walk, not to damage the charge cable.**

c. If nothing works call you Club Car service technician to get a replacement.

Broken/Waterlogged Tablet Screen (see warnings below)

Remove the tablet from your Tempo Walk and call your Club Car service technician to get a replacement. You may have to pay the part cost to replace with a new one.

⚠ WARNING

Battery Use and Safety

The battery in GALAXY is not intended to be replaced by the consumer. If you believe the battery is damaged or needs to be replaced call your Club Car service technician.

- **Do not let the GALAXY or battery come in contact with liquids.**

Liquids can get into the GALAXY's circuits, leading to corrosion. Even when the GALAXY appears to be dry and appears to operate normally, the circuitry could slowly corrode and pose a safety hazard. If the GALAXY and/or battery get wet, have them checked by your service provider or contact Samsung, even if they appear to be working properly.

- **Do not place your battery in or near a heat source.**

Excessive heating can damage the GALAXY or the battery and could cause the GALAXY or the battery to explode. Do not dry a wet or damp battery with an appliance or heat source such as a microwave oven, hair dryer, iron, or radiator. Avoid leaving your GALAXY in your car in high temperatures.

- **Caution: Some applications or prolonged usage may increase device temperature.**

Prolonged skin contact with a device that is hot to the touch may produce skin discomfort or redness, or low-temperature burns. If the device feels hot to the touch, discontinue use and close all applications or turn off the device until it cools. Always ensure that the phone has adequate ventilation and air flow. Covering the device with bedding, your body, thick clothing or any other materials that significantly affect air flow may affect the performance of the phone and poses a possible risk of fire or explosion, which could lead to serious bodily injuries or damage to property.

- **Do not dispose of the GALAXY or the battery in a fire.**

The GALAXY or the battery may explode when overheated.

- **Avoid dropping the GALAXY.**

Dropping the GALAXY, especially on a hard surface, can potentially cause damage to the GALAXY. If you suspect damage to the GALAXY or battery, take it to a service center for inspection.

- **Never use any charger or battery that is damaged in any way.**

Important! Use only Samsung-approved batteries and recharge your battery only with Samsung-approved chargers which are specifically designed for your GALAXY.

Use of a non-Samsung-approved battery or charger may present a risk of fire, explosion, leakage, or other hazard. Samsung's warranty does not cover damage to the GALAXY caused by non-Samsung-

approved batteries and/or chargers.

- Do not use incompatible batteries and chargers. Some websites and second-hand dealers not associated with reputable manufacturers and carriers, might be selling incompatible or even counterfeit batteries and chargers. Consumers should purchase manufacturer or carrier-recommended products and accessories. If unsure about whether a replacement battery or charger is compatible, contact the manufacturer of the battery or charger.
- Misuse or use of incompatible batteries and charging devices could result in damage to the equipment and a possible risk of fire, explosion, or leakage, leading to serious injuries, damages to your phone, or other serious hazard.

Display/Touch-Screen

Please note the following information when using your mobile device:

WARNING REGARDING DISPLAY

The display on your mobile device is made of glass or acrylic and could break if your mobile device is dropped or if it receives significant impact. Do not use if screen is broken or cracked as this could cause injury to you.

WARRANTY DISCLAIMER: PROPER USE OF A TOUCH-SCREEN MOBILE DEVICE

If your mobile device has a touch-screen display, please note that a touch-screen responds best to a light touch from the pad of your finger or a non-metallic stylus. Using excessive force or a metallic object when pressing on the touch-screen may damage the tempered glass surface and void the warranty. For more information, please refer to the "Standard Limited Warranty".

When your Device is Wet

Do not turn on your device if it is wet. If your device is already on, turn it off and remove the battery immediately, if applicable (if the device will not turn off or you cannot remove the battery, leave it as-is). Then, dry the device with a towel and take it to a service center.

TOWING

⚠ WARNING

- **DO NOT TOW TEMPO WALK!!**

LONG TERM STORAGE

See General Warnings on page 6.

⚠ WARNING

- **Never attempt to charge a frozen battery. Frozen batteries can explode, discard battery. TW must never be charged when temperature is below freezing.**
- **Never store the TW unit in a location that gets colder than (-0C ~ 32F)!**
- **Discontinue NOCO G7200 Charger use if the battery becomes excessively warm.**
- **Do not attempt to charge batteries with bulged cases. Discard the battery.**

CAUTION

- **Batteries in a low state of charge will freeze at low temperatures (below 0C/32F).**

- To avoid exposing electrical components to moisture and subsequent damages, do not use any type of pressure washing or steam cleaning equipment to wash Tempo Walk.
- Follow all of the safety precautions in the NOCO Genius Product information Guide and G7200 V2 User guide. These can be downloaded at <https://no.co/downloads>

Immediately Prior to Long Term (> 45 days) Storage, Perform the Following Steps

1. TW must be fully charged before storing.
2. Unit power must be turned off.
3. The main circuit breaker under cooler must be disconnected for winter storage (see video).
4. Remove tablet from TW, power it off (see video), and store indoors.
5. TW should not be connected to NOCO G7200 charger during long term storage.
6. TW must be recharged within 6 months to maintain battery integrity.
7. Unit should be stored in a dry, clean, well ventilated area, between (0-45C/32-113F)
8. Adjust tires to recommended tire pressure.
9. Perform annual periodic lubrication as necessary.
10. Thoroughly clean the unit. For more details on how to clean see “Cleaning Unit” Page 32.

Spring Reactivation Procedures after Long Term Storage

1. Connect unit to NOCO G7200 Genius charger and recharge TW overnight (>6 hours).
2. When unit is charged, reconnect main circuit breaker, located under cooler.
3. Reattach the fully charged tablet to its charging cable, then attach it to the unit, and power the tablet on.
4. Power on TW in a safe/open area to test performance.
5. Adjust tires to recommended tire pressure.
6. Perform the “Pre-Operation and Daily Safety Checklist” on page 11.
7. Perform the “Performance Inspection” on page 11.

Winter Non-Storage Battery Charging Requirements

1. Acceptable battery charging temperatures are (0-40C/32-104F).
2. Should the temperature drop below (5C/40F) use the 24 Volt Cold/AGM charging mode setting on the NOCO G7200 Charger.
3. Should TW be staged in heavy rains or be transported in an open vehicle during rain showers, you must protect the unit electronics by using a rain cover. (See figure 11)



Figure 11 Rain Cover

MAINTENANCE

See General Warnings on page 6.

To ensure trouble-free unit performance, it is very important to follow an established preventive maintenance program. Regular and consistent unit maintenance can prevent unit downtime and expensive repairs that can result from neglect. Use the Pre-Operation and Daily Safety Checklist beginning on page 11, the Performance Inspection, and the following Periodic Service Schedules and Periodic Lubrication Schedules to keep the unit in proper working condition.

- **Any unit not functioning correctly should be removed from use until it is properly repaired. This will prevent further damage to the unit and avoid the possibility of injury due to unsafe conditions.**

Contact your local Club Car distributor/dealer to perform all repairs and annual periodic service.

⚠ WARNING

- **If any problems are found during scheduled inspection or service, do not operate the unit until repairs are made. Failure to make necessary repairs could result in fire, property damage, severe personal injury, or death.**
- **Only trained technicians should service or repair the unit. Anyone doing even simple repairs or service should have knowledge and experience in electrical and mechanical repair. The appropriate instructions must be used when performing maintenance, service, or accessory installation.**

PERIODIC SERVICE SCHEDULES

⚠ WARNING

- **Service, repairs, and adjustments must be made per instructions in the maintenance and service manual.**

NOTE: If the cart is constantly subjected to heavy use or severe operating conditions, the preventive maintenance procedure should be performed more often than recommended in the periodic service and lubrication schedules.

Both the Periodic Service Schedule and Periodic Lubrication Schedule must be followed to keep vehicle in optimum operating condition.

PERIODIC SERVICE SCHEDULE		
REGULAR INTERVAL	SERVICE	
Daily service by owner.	Pre-Operation and Daily Safety Checklist	See Pre-Operation and Daily Safety Checklist on page 11.

	Performance Inspection	See Performance Inspection on page 11. Charge battery daily after every use
	Hand Cleaning	Wipe down unit with wet rag after every use.
Weekly service by owner.	Hand Cleaning	Use air compressor or broom/brush to remove excess grass from tires. Clean Tablet screen and body plastic. See “Cleaning Unit” Page 32
Monthly service by owner or trained technician.	Tempo Walk Inspection	Test each unit to ensure they are following correctly. Follows approx. 4 ft directly behind the user. Notice if brakes are quiet when running.
		Test Dashboard and USB chargers.
	Transmitter Inspection	Make sure transmitters are functioning properly, and toggle switches are not bent. The transmitter is charging fully, and the green LED light is operational.
	Tablet Inspection	Make sure tablet is functioning properly. Specifically, that yardages are accurate and application works correctly.
Annual service by owner or trained technician.	Rear Wheels are rolling freely. Front Caster is rolling and turning freely.	Check and adjust as required. Grease front wheel.
	Safety decals	Check safety decals; replace if damaged or illegible.
Annual service by trained technician only!	Brake System	Check brakes and grease motor gearbox

	Battery	If battery is not performing as expected. See batteries in maintenance and service manual.
	Electrical wiring and connections	Check for tightness and damage; replace if necessary.

Figure 12 Periodic Service Schedule

PERIODIC LUBRICATION SCHEDULES

PERIODIC LUBRICATION SCHEDULE			
REGULAR INTERVAL	SERVICE	LUBRICATION POINTS	RECOMMENDED LUBRICANT
Annually by owner or trained technician. (every 200 hours of operation or 100 rounds of golf)	Front Wheel/Caster	1	Valvoline Multi-Purpose #2 Grade Lithium Complex
	Motor Gear Box Grease Fitting	2	Valvoline Multi-Purpose #2 Grade Lithium Complex

Figure 13 Lubrication Points

BATTERY

See General Warnings on page 7.

⚠ DANGER

- Battery – Explosive gases! Do not smoke near exposed battery. Keep sparks and flames away from the unit and service area.
- Battery – Poison! Contains acid! Causes severe burns. Avoid contact with skin, eyes, or clothing. Antidotes:
 - External: Flush with water. Call a physician immediately.
 - Internal: Drink large quantities of milk or water followed with milk of magnesia or vegetable oil. Call a physician immediately.
 - Eyes: Flush with water for 15 minutes. Call a physician immediately.

⚠ WARNING

- Use insulated tools when working near batteries or electrical connections. Use extreme caution to avoid shorting of components or wires.
- If battery wire terminals are damaged or corroded, replace or clean them as necessary.

Failure to do so may cause them to overheat during operation and could result in fire, property damage, or personal injury.

After use, charge the batteries. The batteries should never be left discharged any longer than absolutely necessary (do not leave discharged overnight)

- **The battery should be stored in full state of charge. The battery can be stored no longer than 6 months before it must be recharged**
 - Never throw the battery into water, keep it under dry, shady and cool conditions when not use.
 - Never switch the positive and negative.
 - Never connect the positive and negative of battery with metal.
 - Never ship or store the battery together with metal.
 - Never knock, throw or trample the battery.
 - Never cut through the battery with nail or other edge tool.
- If battery emits a peculiar smell, heats up, has any case distortion or appears abnormal during usage, storage or charging process, please take it off of the charging device immediately and stop using.
- Never plug the battery into a socket directly; please use the approved charger when charging.

CAUTION

- **On all units, turn off the Power to Tempo Walk before charging battery.**
- **Only approved Lithium Ion Phosphate battery can be used in Tempo Walk**

MATERIAL SAFETY DATA SHEET

Section 1 - Chemical Product and Company Identification

Product Name	Lithium Iron Phosphate Battery(LiFePO4 Battery)
Battery Type	24V 25AH
Nominal Voltage	24V
Nominal Capacity	25Ah
Chemical System	Lithium Iron Phosphate/Carbon
Designed for Recharge	YES
Packing Requirements	Packing Group II
UN Number	UN3480

Section 2 – Composition/Information on Ingredient

Chemical composition	EC NO.	CAS No.	Weight (%)
Lithium Iron Phosphate	-	15365-14-7	27.04
Ferrum	231-096-4	7439-89-6	23.52
Organic Solvent	-	-	13.44
Graphite	231-955-3	7782-42-5	12.78
Cuprum	231-159-6	7440-50-8	9.22
Aluminum	231-072-3	7429-90-5	6.44
Polypropylene	-	9002-88-4	4.37
Lithium Hexafluorophosphate	244-334-7	21324-40-3	2.01
Nickel	-	14332-32-2	1.18

Section 3 - Hazards Identification

Class of division is 9, This product is safe under normal use.

Health Hazards (Acute and Chronic) These chemicals are contained in a sealed enclosure. Risk of exposure occurs only if the battery is mechanically, thermally or electrically abused to the point of compromising the enclosure. Contact of electrolyte and extruded lithium with skin and eyes should be avoided. Sign/Symptoms of Exposure A shorted lithium battery can cause thermal and chemical burns upon contact with the skin.

Section 4 - First Aid Measures

Eye Contact Flush eyes with plenty of water for at least 15 minutes, occasionally lifting the upper and lower eyelids. Get medical aid. Skin Contact Remove contaminated clothes and rinse skin with plenty of water or shower for 15 minutes. Get medical aid. Inhalation Remove from exposure and move to fresh air immediately. Use oxygen if available. Ingestion Give at least 2 glasses of milk or water. Induce vomiting unless patient is unconscious. Call a physician.

Section 5 - Fire Fighting Measures

FlashPoint:N/A. Auto-Ignition Temperature: N/A. Extinguishing Media Dry chemical, CO2. Special Fire - Fighting Procedures Self-contained breathing apparatus. Unusual Fire and Explosion Hazards Cell may vent when subjected to excessive heat-exposing battery contents. Hazardous Combustion Products Carbon monoxide, carbon dioxide, lithium oxide fumes.

Section 6 - Accidental Release Measures

Steps to be Taken in case Material is Released or Spilled

If the battery material is released, remove personnel from area until fumes dissipate. Provide maximum ventilation to clear out hazardous gases. Wipe it up with a cloth, and dispose of it in a plastic bag and put into a steel can. The preferred response is to leave the area and allow the batteries to cool and vapors to dissipate. Provide maximum ventilation. Avoid skin and eye contact or inhalation of vapors.

Waste Disposal Method

It is recommended to discharge the battery to the end, handing in the abandoned batteries to related department unified, dispose of the batteries in accordance with approved local, state, and federal requirements. Consult state environmental protection agency and/or federal EPA.

Section 7 - Handling and Storage

The batteries should not be opened, destroyed or incinerate, since they may leak or rupture and release to the environment the ingredients that they contain in the hermetically sealed container. Do not short circuit terminals, or over charge the battery, forced over-discharge, throw to fire. Do not crush or puncture the battery, or immerse in liquids.

Precautions to be taken in handling and storing

Avoid mechanical or electrical abuse. Stored preferably in cool, dry and well-ventilated area, which is subject to little temperature change. Storage at high temperatures should be avoided. Do not place the battery near heating equipment, or expose to direct sunlight for long periods.

Other Precautions

Batteries may explode or cause burns, if disassembled, crushed or exposed to fire or high temperatures. Do not short or install with incorrect polarity.

Section 8 - Exposure Controls, Personal Protection

Respiratory Protection

In case of battery venting, provide as much ventilation as possible. Avoid confined areas with venting batteries. Respiratory protection is not necessary under conditions of normal use. Ventilation Not necessary under conditions of normal use.

Protective Gloves

Not necessary under conditions of normal use.

Other Protective Clothing or Equipment

Not necessary under conditions of normal use.

Personal Protection is recommended for venting batteries: Respiratory protection, protective gloves, protective clothing and safety glass with side shields.

Section 9 - Physical and Chemical Properties

Nominal Voltage:	24V
Nominal Capacity:	25Ah
Electric Energy:	600Wh
Physical State:	Solid
Appearance:	Battery, Battery Pack

Section 10 - Stability and Reactivity

Optimum Nano batteries are stable under normal usage.

Stability

Stable

Conditions to Avoid

Avoid exposing the battery to fire or high temperature. Do not disassemble, open, crush, puncture, incinerate, short circuit across the terminals or install with incorrect polarity. Avoid mechanical abuse and electrical abuse. The batteries are incompatible with water, moisture, oxidizing agents, reducing agents, acids and bases.

Hazardous Decomposition Products

This material may release toxic fumes if burned or exposed to fire.

Hazardous Polymerization

Will not occur.

If leaked, it is forbidden to contact with strong oxidizers, mineral acids, strong alkalis, halogenated hydrocarbons.

Section 11 - Toxicological Information

Inhalation, skin contact, and eye contact are possible when the battery is opened. Exposure to internal contents, the corrosive fumes will cause irritation to skin, eyes and mucous membranes. Over exposure can cause symptoms of non-fibrotic lung injury and membrane irritation.

Section 12 - Ecological Information

When promptly used or disposed the battery does not present environmental hazard. When disposed, keep away from water, rain and snow.

Section 13 - Disposal Considerations

APPROPRIATE METHOD OF DISPOSAL OF SUBSTANCE OF PREPARATION

If batteries are still fully charged or only partially discharged, they can be considered a reactive hazardous waste because of significant amount of uncreated, or unconsumed lithium remaining in the spent battery. The batteries must be neutralized through an approved secondary treatment facility prior to disposal as a hazardous waste. Recycling of battery can be done in authorized facility, through a licensed waste carrier.

Section 14 - Transport Information

Lithium battery complies with the UN Recommendations on the Transport of Dangerous Goods; IATA Dangerous Goods regulations and applicable US DOT regulations for the safe transport of Lithium battery. Batteries containing these cells should be transported as Class 9 hazardous material except for those battery types declared to be exempt (contact Concorde for a current listing of exempt batteries) and/or the Lithium battery have been tested under provisions of the UN Manual of Tests and Criteria, Part III, sub-section 383 and are classified as non-dangerous goods. The product is not classified as dangerous Goods according to the current edition of IATA Dangerous Goods Regulations And not regulated by IATA DGR, This product fully conforms to IATA Shipping PI 965, section IB. Do not damage or mishandle this package If package is damaged, batteries must be quarantined inspected, and repacked For emergency information, ca11:+86-755-66835999 The Lithium battery according to

NEW PACKING INSTRUCTION

965-967 Of IATA DGR 58th Edition for transportation. Each package had labeled with a Lithium battery handling label. The following information is provided for domestic and international transport.

DOT regulations:	
UN Classification (Transport Hazardous) :	9
UN number:	3480 Or 3481
Packing group:	II
UN Proper shipping name (technical name) :	LITHIUM BATTERIES
Marine pollutant (Y/N)	Y
Label	9
Land transport ADR/RID (cross-border) :	

ADR/RID class:	9	Miscellaneous dangerous substances
Danger code (Kemler):	9	
UN-Number:	3480 Or 3481	
Packaging group:	II	
Marine pollutant (Y/N):	N	
Label:	9	
Description of goods:	3480 Or 3481 Lithium batteries	
Sea transport IM DG :		
IMDG Class:	9	
UN Number:	3480 Or 3481	
Label:	9	
Packaging group:	II	
EMS Number:	F-A, S-I	
Marine pollutant (Y/N):	Y	
Special regulate:	IMO 188	
Proper shipping name:	Lithium batteries	
Air transport ICAO-TI and IATA-DGR:		
UN/ID Number:	3480 Or 3481	
Label:	9	
Packaging group:	II	
Marine pollutant (Y/N):	N	
Proper shipping name:	Lithium batteries	

Section 15 - Regulatory Information

Law Information

- 《Dangerous Goods Regulation》
- 《Recommendations on the Transport of Dangerous Goods Model Regulations》
- 《International Maritime Dangerous Goods》
- 《Technical Instructions for the Safe Transport of Dangerous Goods》
- 《Classification and code of dangerous goods》
- 《Occupational Safety and Health Act》 (OSHA)
- 《Toxic Substances Control Act》 (TSCA)
- 《Consumer Product Safety Act》 (CPSA)
- 《Federal Environmental Pollution Control Act》 (FEPCA)
- 《The Oil Pollution Act》 (OPA)
- 《Superfund Amendments and Reauthorization Act Title III (302/311/312/313)》 (SARA)
- 《Resource Conservation and Recovery Act》 (RCRA)
- 《Safety Drinking Water Act》 (CWA)
- 《California Proposition 65》
- 《Code of Federal Regulations》 (CFR)

In accordance with all Federal, State and Local laws.

Section 16 - Additional Information

The above information is based on the data of which we are aware and is believed to be correct as of the date hereof. Since this information may be applied under conditions beyond our control and with which we may be unfamiliar and since data made available subsequent to the date hereof may suggest modifications of the information, we do not assume any responsibility for the results of its use. This information is furnished upon condition that the person receiving it shall make his own determination of the suitability of the material for his particular purpose.

BATTERY CHARGER

⚠ DANGER

- Do not charge the unit battery with the unit covered or enclosed. Any enclosure or cover should be removed or unzipped and pulled back when battery is being charged.

⚠ WARNING

- Only trained technicians should repair or service the charger. Contact your nearest authorized Club Car distributor/dealer.
- This appliance is not intended for use by persons (including children) with reduced physical, sensory or mental capabilities, or lack of experience and knowledge. Children should be supervised to ensure that they do not play with the appliance.
- DO NOT operate the charger if it has received a sharp blow, was dropped, or otherwise damaged in any way. Have worn, cut, or damaged power cords or wires replaced immediately.
- Do not expose to rain or any liquid. Keep the charger dry.
- Do not connect the charger to a receptacle if the charger cord, plug, or the unit receptacle is broken, damaged, or does not make a good electrical connection. Fire or personal injury can result. Have a qualified technician replace any damaged parts.
- When the charger is on, the charger cord should be disconnected from the unit receptacle slowly. Jerking or pulling the charging cord out quickly could cause arcing and burning that could damage the plug and receptacle and could cause battery to explode.

⚠ WARNING

- Do not cover the charger. Do not allow clothing, blankets, or other material to cover the charger. The charger must dissipate heat and protect from overheating.

CAUTION

- The battery charger provided with this unit is approved for use only with the battery type originally shipped with the unit. Club Car only recommends OEM replacement battery. Contact your authorized Club Car dealer/distributor with any questions about battery and charger compatibility

CHARGER POWER CORD

⚠ WARNING

- Install surge arrestors on incoming power lines. Surge arresters will help protect electrical components in the charger and on the unit from all but direct or close lightning strikes.

⚠ WARNING

- Two NOCO G7200 chargers can share the same GFCI outlet. A normal 110-120 VAC, 50-60Hz outlet is sufficient (US). The charging current is 3.6A per charger. Ensure that the outlet has more capacity than the combined charging current of all chargers plugged in.
- Connect the charger power cord to a properly grounded, three-wire outlet within the voltage and frequency range shown on the charger.
- Place all cords so they will not be stepped on, tripped over, or otherwise subjected to damage or stress.

The power plug must be connected to an appropriate receptacle that is properly installed and grounded in accordance with the National Electrical Code and all local codes and ordinances.

The use of an extension cord with the charger should be avoided. If one must be used, heed the following WARNING.

⚠ WARNING

- An extension cord or electrical outlet must accept a three-prong plug. The extension cord should be a three-wire No. 12 AWG (American Wire Gauge) or no. 14 (British Standard Wire Gauge), and be as short as possible (no more than 12 feet (3.7 m)). The use of an improper extension cord could result in fire or an electrical shock.

PLUG AND RECEPTACLE

The charger cord, plug, and receptacle are wear items and should be inspected daily. Visually inspect them for cracks, loose connections, and frayed wiring; they must be replaced when worn or damaged.

⚠ WARNING

- If pins are bent, the plug must be replaced immediately. The plug is not serviceable. Do not attempt to repair the plug or straighten bent pins. Contact your local authorized Club Car dealer or distributor for repairs.

CHARGER MOUNTING

Use the mounting holes to secure the charger (Figure 14). Position the charger so that it has adequate ventilation and the charger status indicator panel is visible. The charger can be mounted in multiple orientations (vertical, horizontal) provided it has adequate ventilation (Figure 15).

To help ensure optimal charge times, mount the charger in an area where ambient temperatures during charging remain below 104 °F (40 °C).

⚠ WARNING

- Make sure the charger is securely mounted. Only hang the charger by its designate mounting holes with provided screws.

- Place all cords so they will not be stepped on, tripped over, or otherwise subjected to damage, stress, or water.

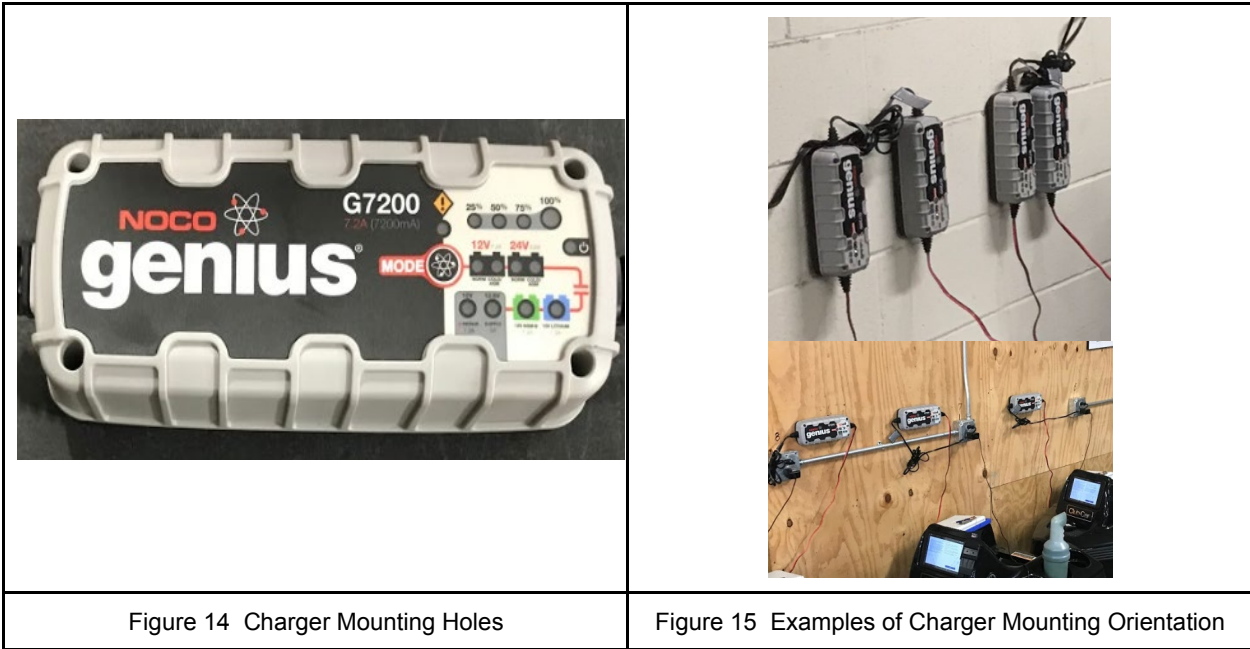

INPUT VOLTAGE DETECTION: The NOCO G7200 charger automatically detects the input voltage and will operate at full power if the voltage is within the 110 to 120 VAC range.

THERMAL CUTBACK The NOCO charger operates at full power in ambient temperatures between -40 °F (-40 °C) and 104 °F (40 °C). The charger also will function outside of that range although charging times will be longer.

CHARGE STATUS INDICATORS The charge status indicator lights on the NOCO charger provide information concerning charge and charger status (Figure 16).





LED	Explanation
<p>25% Red LED</p> <p>25% 50% 75% 100%</p> 	<p>The 25% Charge LED will slowly pulse "on" and "off", when the battery is less than 25% fully charged. When the battery is 25% charged, the red Charge LED will be solid.</p>
<p>50% Red LED</p> <p>25% 50% 75% 100%</p> 	<p>The 50% Charge LED will slowly pulse "on" and "off", when the battery is less than 50% fully charged. When the battery is 50% charged, the red Charge LED will be solid.</p>
<p>75% Orange LED</p> <p>25% 50% 75% 100%</p> 	<p>The 75% Charge LED will slowly pulse "on" and "off", when the battery is less than 75% fully charged. When the battery is 75% charged, the orange Charge LED will be solid.</p>
<p>100% Green LED</p> <p>25% 50% 75% 100%</p> 	<p>The 100% Charge LED will slowly pulse "on" and "off", when the battery is less than 100% fully charged. When the battery is fully charged, the green LED will be solid, and the 25%, 50% and 75% Charge LEDs will turn "off".</p>
<p>Maintenance Green LED</p> <p>25% 50% 75% 100%</p> 	<p>During maintenance charging, the 100% Charge LED will pulse "on" and "off" slowly. When the battery is topped off and fully charged again, the 100% Charge LED will turn solid green. The charger can be left connected to the battery indefinitely.</p>

Figure 16 NOCO G7200 Charger Status Indicators

CHARGING PROCEDURES









<p><u>Turn Transmitter OFF</u></p> 	<p><u>Plug in Charger</u></p> 	<p><u>Check for Orange light</u></p> 	<p><u>When Full Light goes OFF</u></p> 
<p><u>Turn Tempo Walk OFF</u></p> 	<p><u>Plug in Charger</u></p> 	<p><u>Check for Flashing light</u></p> 	<p><u>Full Green Light ON</u></p> 

Figure 17 Transmitter and Tempo Walk Charging Steps

CHARGING BATTERY

See Dangers and Warnings at Battery Charger beginning on page 26.

⚠ WARNING

- Be sure all wire connections at the receptacle are clean and tight.
- Do not rock or bend the plug. To connect the charger plug to the unit receptacle, grasp the plug tab and push the plug straight into the receptacle.
- Do not pull on the charger cord (Figure 18) use the red spring release to disconnect the plug. Do not twist, rock or bend the plug. To disconnect the charger plug from the unit receptacle, grasp the plug by the tab, press the red spring release, and pull the plug straight out of the receptacle.
- Do not connect a charger to the receptacle if the charger cord, plug, or the unit receptacle is broken, damaged in any manner, or does not make a good electrical connection. Fire or personal injury can result. Have it replaced by a qualified service person immediately. Failure to follow these instructions could result in damage to the charger cord, the plug, and (or) the unit receptacle.
- Do not attempt to charge frozen batteries or batteries with bulged cases. Discard the battery in accordance with all environmental laws or return to an authorized Club Car dealer. Frozen batteries can explode.

- Do not use a charger if any of the following conditions exist:
 - The plug is too loose or does not make a good connection.
 - The plug and receptacle feel hotter than normal during charge.
 - The plug pins or receptacle contacts are bent or corroded.
 - The plug, receptacle, or cords are cut, worn, have exposed wires or are damaged in any way.
- Using the charger with any of the above symptoms could result in a fire, property damage, personal injury, or death.

CAUTION

- On all units, turn off Tempo Walk before charging battery.
- The battery charger provided with this unit is approved for use only with the battery type originally shipped with the unit. Using a different battery type (different brand, different capacity, etc.) can cause under or overcharging and subsequent battery damage. Club Car recommends only OEM replacement battery. Contact your authorized Club Car dealer/distributor with any questions about battery and charger compatibility.

Battery Charging Procedure

1. With the charger cord disconnected from the unit charger receptacle, connect the power supply cord to an outlet designed to provide the proper voltage for the NOCO G7200 charger.
2. Insert the charging plug into the unit receptacle. When inserting the charging plug, align the raised guide on the plug with the guide slot in the receptacle and push straight in slowly (Figure 18).
3. The charger will turn on in two to five seconds later, after the lockout function activates.
4. As long as the charger is allowed to shut off by itself, the battery will be fully charged. Overcharging and undercharging will normally be prevented.
5. If the charger does not seem to be operating properly, or if the battery seems weak, contact your local Club Car distributor/dealer.



Figure 18 **CORRECT** Insertion of Charger Plug



Figure 19 **INCORRECT** Insertion of Charger Plug

RESETTING NOCO CHARGER POWER

See Charge Status Indicators on page 29. Before replacing the charger, you can attempt to reset the charger in case the failure was caused by a temporary situation. To reset charger power, take the following steps:

1. Unplug the charging cord from the unit.
2. Unplug the charger power plug from the power source.
3. Wait for the red light to go off, wait 30 seconds, then plug in the power cord.
4. When the power indicator light comes on, plug in the charging cord.
5. If the power indicator light does not come on, contact your Club Car dealer. If the light does come back on, attempt to charge the cart as usual.

CLEANING THE UNIT

- Club Car Tempo Walk units are equipped with hand-washable bodies. Use only commercially available automotive cleaners with a sponge or soft cloth for normal cleaning.
- To clean the Tablet use Windex or other similar products and wipe down screen with a clean towel.
- **The manufacturer does not recommend any type of pressure washing or steam cleaning. Such a process will expose electrical components to moisture. Moisture entering electrical components can result in water damage and subsequent component failure.**
- Battery acid, fertilizers, tars, asphalt, creosote, paint, or chewing gum should be removed immediately to prevent possible stains. See following CAUTION.

CAUTION

- **Use of leveling or rubbing compounds will permanently dull finish of unit.**
- **Do not apply wax products as they may cause surfaces to become discolored.**

ACCESSORIES

A complete line of parts and accessories is available from Club Car channel partners. To find your local authorized Club Car dealer, visit www.clubcardealer.com, or call 1-800-ClubCar (258-2227).

Care should be taken that these accessories are properly installed by trained technicians, and that they are used in the manner for which they were designed. See following WARNING.

SUBSEQUENT OWNER REGISTRATION

In the event a unit is bought as a used unit, we strongly urge the new owner to register the unit with Club Car. This will enable us to contact you if the need arises. Please send your name, address, and serial number(s) of the unit(s) to Club Car, LLC, P.O. Box 204658, Augusta, Georgia 30917-4658, Attention: unit Registration.

TEMPO WALK SPECIFICATIONS

Part	Specifications
MOTOR/ELECTRICAL COMPONENTS	
Drive Motor	Direct Drive 24V DC, 160-RPM, Custom Gear Box (see Motor Specs below)
Brake	Wagner 3N-m
Electrical System	24V DC, reduced speed reverse
Battery	24V 25Ah Lithium Iron Phosphate, Top Post, Deep Cycle, 2,500+ recharges (see Battery Specs below)
Charger	NOCO Genius G7200 – 3.6 Amp 24V Charger (see Battery Charger Specs below)
Tablet	8", Cellular/WiFi/GPS, Android 7.0, Processor 1.2GHz, RAM 1.5GB, Storage 16GB Battery 4200 mAh
BODY/CHASSIS	
Frame	Aluminum Box Style, Powder Coated
Body	Vacuum Formed ABS Plastic "220/1000", UV protection
USB Port	5 Volt. 2.4 Amp
Front Wheel	Kenda "Turf Rider" 11x4.0x4 Tubeless 2 ply. Max. PSI 22
Rear Wheels	Kenda "Turf Rider" 13x6.5x6 Tubeless 2 ply. Max PSI 14
DIMENSIONS/WEIGHT	
Unit Weight	97 lbs (44 kg)
Overall Length	37 in. (94 cm)
Overall Width	33 in. (84 cm)
Overall Height	28 in. (71 cm)
Forward Speed	4 - 6 mph (6.5 to 9.7 km/h)
Clearance (No Curbs)	5 in. (12 cm)
TIRE PRESSURE	
Front/Rear Recommended	22 PSI/14 PSI

BATTERY SPECIFICATIONS

Cylindrical Lithium Iron Phosphate Battery

OPT-24025



Brief Introduction

OptimumNano always develop and produce 32650 cells to or assemble battery packs to satisfy the requirements of high performance and operational reliability of our customers. We also have the 14500/18650/22650/26650 cells to meet all your requirements.

Key Features

- Attractive cycle life
- Extended safety performance
- Wide operating temperature range
- Unrivalled high temperature performance
- Green energy without metal contaminant
- High capacity
- Steady output voltage
- Little self-discharge
- Double safety protection
- Withstanding very high level of vibrations and shocks

Safety Characteristics

- Over-charge/Over-discharge Ability to withstand over-charge/withstand over-discharge, and there is no fire, no exploding and work well
- Short circuit Ability to withstand short circuit, and there is no fire, no exploding
- Acupuncture Ability to withstand nail puncturing, and there is no fire, no exploding
- Thermal shock Ability to withstand thermal shock, and there is no fire, no exploding

Electrical Characteristics

Nominal Voltage	24V
Nominal Capacity	25Ah
Impedance (Max. at 1000Hz)	≤50mΩ

Mechanical Characteristics

Height	170 ± 2mm
Width	165 ± 2mm
Length	198 ± 2mm
Weight	~7.5Kg

Operation Conditions

Charge Method	Constant Current/Constant Voltage (CC-CV)
Max. Charge Voltage	29.2V
Standard Charge Current	5A
Charge Temperature	0°C ~ 45°C
Continuous Discharge Current	25A
Peak Instant Discharge Current	50A
Peak Instant Discharge Time	5 seconds
Discharge Cut-off Voltage	20.0V
Discharge Temperature	-20°C ~ 65°C
Storage Temperature	-20°C ~ 45°C

This document is the enterprise standard of OPTIMUNANO, without authorization, any pirate or circulation is not allowed.

BATTERY CHARGER SPECIFICATIONS

Charging Modes			
Mode	Explanation		
Standby	No Power In standby mode, the charger is not charging or providing any power to the battery. Energy Save is activated during this mode, drawing microscopic power from the electrical outlet. When selected, an orange LED will illuminate.	24V COLD/AGM	29.6V 3.6A Up To 115Ah Batteries For charging 24-volt batteries in cold temperatures below 50°F (10°C) or AGM batteries. When selected, a blue LED will illuminate.
		12V LITHIUM Press & Hold	14.2V 7.2A Up To 230Ah Batteries For charging 12-volt lithium ion batteries, including lithium iron phosphate. When selected, a blue LED will illuminate.
12V NORM	14.5V 7.2A Up To 230Ah Batteries For charging 12-volt Wet Cell, Gel Cell, Enhanced Flooded, Maintenance Free and Calcium batteries. When selected, a white LED will illuminate.	12V AGM+ Press & Hold	15.5V 7.2A Up To 230Ah Batteries For charging 12-volt advanced AGM batteries, which requires a higher than normal charging voltage. When selected, a blue LED will illuminate.
12V COLD/AGM	14.8V 7.2A Up To 230Ah Batteries For charging 12-volt batteries in cold temperatures below 50°F (10°C) or AGM batteries. When selected, a blue LED will illuminate.	13.6V SUPPLY Press & Hold	13.6V 5A Max 6A Converts to a DC power supply for powering any 12VDC device, like a tire inflator, oil changer, or as a memory retainer when replacing a battery. When selected, a red LED will illuminate.
24V NORM	29V 3.6A Up To 115Ah Batteries For charging 24-volt, Wet Cell, Gel Cell, Enhanced Flooded, Maintenance Free and Calcium batteries. When selected, a white LED will illuminate.	12V REPAIR Press & Hold	16.5V 1.5A Any Capacity An advanced battery recovery mode for repairing and storing old damaged, stratified, or sulfated batteries. When selected, a red LED will illuminate and flash.

Technical Specifications			
Input Voltage AC:	110-120 VAC, 50-60Hz	Type of Batteries:	12V & 24V
Working Voltage AC:	85-130 VAC, 50-60Hz	Battery Chemistries:	Wet, Gel, MF, CA, EFB, AGM, LiB
Efficiency:	85% Approx.	Battery Capacity:	Up To 230Ah (12V), Up To 115Ah (24V), Maintains All Battery Sizes
Power:	132W Max	Housing Protection:	IP65
Low-Voltage Detection:	2V (12V), 14V (24V)	Cooling:	Natural Convection
Back Current Drain:	<5mA	Dimensions (LxWxH):	8.8 x 3.7 x 2.3 in (224 x 94 x 58mm)
Ambient Temperature:	0°C to +40°C, 32°F to +104°F	Weight:	1.73 Pounds (0.78 kg)
Charger Type:	8 Step, Smart Charger		

Charging Steps	What's In The Box
	<ul style="list-style-type: none"> • G7200 Smart Charger • Battery Clamp Connectors w/ Integrated Eyelets • User Guide and Information Guide & Warranty



Retail Packaging:
Dimensions: 12.60"x3.94"x4.49"
(320 x 100 x 114mm)
Weight: 2.57lbs (1.17kg)
UPC: 0-46221-10034-1
Inner Carton:
Dimensions: 12.95"x4.29"x4.96"
(329 x 109 x 126mm)

(cont'd) Weight: 2.89lbs (1.31kg)
Master Carton:
Dimensions: 22.52"x13.58"x10.79"
(572 x 345 x 274mm)
Weight: 30.60lbs (13.88kg)
Quantity: 10
UCC: 10046221100346
Units Per Pallet: 300 Units



CONFORMS TO UL STD. UL1258
SERIALIZED TO CSA STD. C22.2 No. 191.2

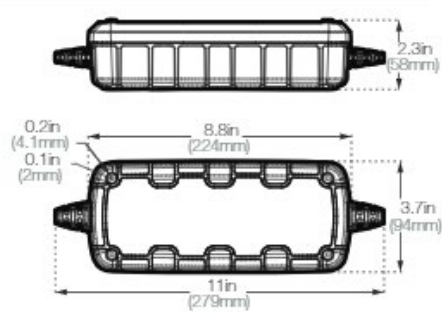

AC Cable: 75 in (190.5cm)
DC Cable: 56 in (142.24cm)

The NOCO Company
30339 Diamond Parkway, #102
Cleveland, OH 44139 | USA
1.800.456.6626

no.co

NOCO
Since 1914

TEMPO WALK LIMITED WARRANTY:

Warranty: Club Car (“Tempo Walk”) hereby warrants to the original purchaser or lessee, that its new Tempo Walk cart, or new component purchased from Club Car, shall be free from defects in material and workmanship, under normal use and service for the periods stated below, subject to the provisions, limitations and exclusions in this limited warranty.

This limited warranty covers material, workmanship, and repair labor costs as to those items specifically listed below for the periods specified. Such repair labor shall be performed only by Club Car, or authorized Club Car dealers or distributors. For repairs made by authorized technicians, other than Club Car or authorized Club Car personnel, Club Car will provide only the replacement parts or components.

If the warranty registration form is not completed and returned to Club Car at the time of the original sale, purchaser must provide proof of date of purchase with warranty claim.

Warranty Info	
<u>Component</u>	<u>Tempo Walk Offer</u>
Cart Frame	Limited Lifetime
Lithium Battery	2-year Free Replacement & 4 year Prorated
Electric Motor/Brake	2-year Free Replacement & 4 year Prorated
Wheel & Tire	2 year
Electronics: All Boards and Transmitter	2 year
Plastic Body Parts	3 year
Unit Charger	4 year
Tablet	1 year
All Remaining Components	2 year

Exclusions: Excluded from any Club Car warranty, is damage to a Tempo Walk or component, resulting from a cause other than a defect, including neglect, abuse, accident, and collision, unreasonable or unintended strain or use, improper installation of components or accessories, poor or neglectful maintenance, installation of parts or accessories that are not original equipment, non-approved alterations and acts of God. Also, excluded from any Club Car warranty are all fuses, decals (except "caution" decal), routine wear items such as charger plug and receptacle, pads, light bulbs, bolts, cosmetic deterioration, on/off buttons, and items that deteriorate, fade or fail due to exposure or ordinary wear or tear.

The Provisions of this limited warranty shall not apply to failure due to the following conditions:

1.1) Improper charging of Tempo Walk due to use of a charger not originally provided with the unit, or not approved by Club Car for use with Tempo Walk.

1.2) Abuse such as overcharging, undercharging, loose wiring, or compromised charging connectors and cables.

1.3) Neglect, breakage, freezing, fire, explosion, wreckage, melted terminal posts, or the operation of Tempo Walk in an uncharged condition. The installation of batteries in reverse, or recharging in reverse, breakage of cases, terminal posts, or batteries used in applications for which they were not designed.

1.4) A battery damaged by a defective charger, or a battery in a Tempo Walk that does not receive proper charging.

2) Lack of proper maintenance such as preventative maintenance checks, maintaining proper tire pressure, tightening loose wires, connectors, and fasteners.

3) Damages caused by improper installation of component.

4) Failed electronics parts, such as diodes, resistors, fuses that are vulnerable to electrical overloads (Including lightning) beyond the control of Club Car.

5) Damaged charger or cord set with plug, which is a wear item and subject to user abuse.

Without limiting the generality of the foregoing in any way, and as part of its limited exclusion, Club Car does not warrant that Tempo Walk or components such as batteries, computer controllers, or electrical devices are suitable for use in any application other than its products. As with any vehicle, batteries, computer controllers or electrical devices; a prudent owner will read and study the operator instructions, tutorials, safety information, and warning labels, and will exercise due care in working on or around vehicles, batteries or electrical devices. Transportation expenses for warranty services are also excluded from this warranty.

Voiding of warranty: This warranty shall be void if Tempo Walk or any component is abused or used in an unintended manner or shows indication that it has been altered in any way including but not limited to, modification of the motor brakes, motors electronic components, software, settings or other operating specifications. The warranty is likewise void if the unit shows indications that reasonable or necessary maintenance as outlined in Tempo Walk owners manual, was not performed at the time and in the manner specified in such information.

Sole Remedy: Club Car liability under this limited warranty or in any action whether based upon warranty, contract, negligence, strict product liability or otherwise, shall be repair or replacement, at Club Car option, of Tempo Walk or component thereof that Club Car deems to be defective. Replacement shall mean furnishing during the applicable limited warranty period a component thereof that is identical or reasonably equivalent to the warranted component at no cost to the purchaser. Repair shall mean remedying a defect in Tempo Walk or component thereof at no cost to the purchaser during the applicable limited warranty period. Club Car reserves the right to test any component returned for adjustment. All parts and components replaced under warranty shall become the property of Club Car

Disclaimer: This warranty is exclusive, Club Car makes no other warranty of any kind, expressed or implied. Any implied warranties of merchantability or fitness for a particular purpose are hereby disclaimed by Club Car and excluded from this warranty. The purchaser and Club Car expressly agree that the sole remedy of the replacement or repair of the defective Tempo Walk or component thereof is the sole remedy of the purchaser. Club Car makes no other representation or warranty of any kind, and no representative or employee has the authority to make or imply any representation, promise or agreement, which in any way varies the terms of this warranty.

No Consequential Damages: In no event shall Club Car be liable for any incidental or consequential damages including, but not limited to, loss related to property other than Tempo Walk, loss of use, loss of time, inconvenience, or any other economic loss. Some States allow neither limitation on the duration of an implied warranty nor exclusions or limitations of incidental or consequential damages. Therefore, the above limitations or exclusions may not apply to you. This warranty gives you specific legal rights, and you may also have other rights, which may vary from state to state.

How to make a warranty claim: To make a warranty claim under this limited warranty, you must present Tempo Walk or defective component with evidence of proof or purchase date, and serial number to an authorized Club Car dealer. For warranty related communication, contact 1-800-CLUBCAR or cci_warrantyadministration@clubcar.com.

Warning: Any modification or change to Tempo Walk that affects the electrical system, computer, software, or stability beyond the original specification, could result in severe personal injury or death.

MOST FREQUENT WARRANTY WORK

	<u>Where Performed</u>		<u>Who Performs</u>			<u>Economics</u>			
	At Site	C.C. / S.D.C	Course Staff	Sales Rep	Warranty Maint Rep	Within Warranty		Outside Warranty	
<u>Item</u>						Labor	Parts	Labor	Parts
Transmitter Toggle Switch	X		X	X		N/A	Provided	N/A	Provided
Transmitter replacement	X		X	X		N/A	Provided	N/A	TBD
Dashboard	X		X	X		N/A	Provided	N/A	TBD
Tempo Walk top replacement	X				X	10 min	Provided	10 min	TBD
USB charger replacement	X			X	X	10 min	Provided	10 min	TBD
Sensor replacement	X		X	X	X	15 min	Provided	15 min	TBD
Micro USB-B replacement	X				X	15 min	Provided	15 min	TBD
Motor Replacement	X				X	30 min	Provided	30 min	TBD
Computer Electronics Replacement	X	X			X	15 min	Provided	15 min	TBD
Battery	X	X			X	30 min	Provided	30 min	TBD
Master Circuit Breaker	X				X	15 min	Provided	15 min	TBD
Antenna	X				X	10 min	Provided	10 min	TBD
Tablet	X		X	X	X	N/A	Provided	N/A	TBD
TW Charger	X		X	X	X	10 min	Provided	10 min	TBD

Notes

