



FCC TEST REPORT

FCC ID:2ATSQ-ZK902A

Product	:	Vacuum Cleaner
Model Name	:	ZK902A
Additional model	:	ZK902B,ZK902C,ZK902D,ZK902E,ZK902F,ZK902G,ZK902H,ZK902J, ZK902K,ZK902L,ZK902M,ZK902N,ZK902P,ZK902Q,ZK902R,ZK902T, ZK902U,ZK902V,ZK902W
Brand	:	小旋风 Smart Cyclone
Report No.	:	PTC21011300402E-FC02
Prepared for		
Dongguan Zhike Intelligent Science and Technology Co., Ltd		
#1 , Juxin 1st Road , Dalang Town ; Dongguan City , Guangdong Province,China		
Prepared by		
Precise Testing & Certification Co., Ltd.		
Building 1, No. 6, Tongxin Road, Dongcheng Street, Dongguan, Guangdong, China.		



1 TEST RESULT CERTIFICATION

Applicant's name : Dongguan Zhike Intelligent Science and Technology Co., Ltd
Address : #1, Juxin 1st Road, Dalang Town; Dongguan City, Guangdong Province, China
Manufacture's name : Dongguan Zhike Intelligent Science and Technology Co., Ltd
Address : #1, Juxin 1st Road, Dalang Town; Dongguan City, Guangdong Province, China
Product name : Vacuum Cleaner
Model name : ZK902A
Additional model : ZK902B, ZK902C, ZK902D, ZK902E, ZK902F, ZK902G, ZK902H, ZK902J, ZK902K, ZK902L, ZK902M, ZK902N, ZK902P, ZK902Q, ZK902R, ZK902T, ZK902U, ZK902V, ZK902W
Standards : FCC Part15 Subpart E , Paragraph 15.407
ANSI C63.10: 2013,
Test procedure : KDB 789033 D02 General UNII Test Procedures New Rules v02r01
KDB662911 D01 Multiple Transmitter Output v02r01
Test Date : Jan. 18, 2021 to Mar. 02, 2021
Date of Issue : Mar. 02, 2021
Test Result : Pass

This device described above has been tested by PTC, and the test results show that the equipment under test (EUT) is in compliance with the FCC requirements. And it is applicable only to the tested sample identified in the report.

This report shall not be reproduced except in full, without the written approval of PTC, this document may be altered or revised by PTC, personal only, and shall be noted in the revision of the document.

Test Engineer:

Leo Yang / Engineer

Technical Manager:

Chris Du / Manager



Contents

	Page
1 TEST RESULT CERTIFICATION.....	2
2 TEST SUMMARY.....	5
2.1 DESCRIPTION OF TEST MODES.....	6
3 GENERAL INFORMATION.....	7
3.1 ANTENNA INFOMATION.....	7
3.2 GENERAL DESCRIPTION OF E.U.T.....	8
3.1 CHANNEL LIST.....	9
3.2 TEST SITE.....	9
4 EQUIPMENT DURING TEST.....	10
4.1 EQUIPMENTS LIST.....	10
4.2 MEASUREMENT UNCERTAINTY.....	11
4.3 DESCRIPTION OF SUPPORT UNITS.....	11
5 CONDUCTED EMISSION TEST.....	12
5.1 TEST STANDARD AND LIMIT.....	12
5.2 TEST SETUP.....	12
5.3 TEST PROCEDURE.....	12
6 . RADIATION SPURIOUS EMISSION AND BAND EDGE.....	15
6.1 TEST STANDARD AND LIMIT.....	15
6.2 TEST SETUP.....	16
6.3 TEST PROCEDURE.....	17
6.4 TEST DATA.....	18
7 MAXIMUM PEAK OUTPUT POWER TEST.....	39
7.1 TEST STANDARD AND LIMIT.....	39
7.2 TEST SETUP.....	39
7.3 TEST PROCEDURE.....	39
7.4 TEST DATA.....	40
8 OCCUPY BANDWIDTH TEST.....	43
8.1 TEST STANDARD.....	43



8.2 TEST SETUP.....	43
8.3 TEST PROCEDURE.....	43
8.4 TEST DATA.....	44
9 POWER SPECTRAL DENSITY TEST.....	76
9.1 TEST STANDARD AND LIMIT.....	76
9.2 TEST SETUP.....	76
9.3 TEST PROCEDURE.....	76
9.4 TEST DATA.....	77
10 ANTENNA REQUIREMENT.....	95
10.1 TEST STANDARD AND REQUIREMENT.....	95
10.2 ANTENNA CONNECTED CONSTRUCTION.....	96
11 APPENDIX I -- PHOTOGRAPH.....	96



2 Test Summary

Standard	Test Type	Result
15.207 & 15.407	Conducted Emission	PASS
15.205/15.209	Spurious Emission	PASS
15.407(b)	Band Edge	PASS
15.407(a)(5)&15.407(e)	Occupy Bandwidth	PASS
15.407(a)(3)	Maximum Conducted Output Power	PASS
15.407(a)(1)(3)	Peak Power Spectral Density	PASS
15.203	Antenna Requirement	PASS



2.1 Description of Test Modes

To investigate the maximum EMI emission characteristics generated from EUT, the test system was pre-scanning tested based on the consideration of following EUT operation mode or test configuration mode which possibly have effect on EMI emission level. Each of these EUT operation mode(s) or test configuration mode(s) mentioned above was evaluated respectively.

Mode	Test channel	Frequency (MHz)
OFDM(802.11a/n20/ac20)	CH 149	5745MHz
	CH 157	5785MHz
	CH 165	5825MHz
OFDM(802.11n40/ac40)	CH 151	5755MHz
	CH 159	5795MHz
OFDM(802.11ac80)	CH 155	5775MHz

Note:

1. The measurements are performed at the highest, middle, lowest available channels.
2. The EUT has been tested as an independent unit. And Continual Transmitting in maximum power.
3. For the relevant Conducted Measurement, the temporary antenna connector is used during the measurement. Antenna Connector Impedance: 50Ω, Cable Loss: 1.0 dB
4. The EUT was programmed to be in continuously transmitting mode and the transmit duty cycle is more than 98%



3 General Information

3.1 Antenna Information

Ant No	Brand	Model	AntennaType	Connector	Gain(dbi)
1	-	-	PIFA antenna	-	3.0
2	-	-	PIFA antenna	-	3.0

Note:

1. The EUT has Two antennas, which can support IEEE802.11A/N20/N40/AC20/AC40/AC80, and can support IEEE802.11N20/N40/AC20/AC40/AC80 with the MIMO function
2. According to ANSI C63.10:2013 14.4.3.2.5 a):
 $\text{Directional gain} = 3.0\text{dbi} + 10 \times \log(2/1)\text{db} = 6.01\text{dBi} > 6\text{dBi}$



3.2 General Description of E.U.T.

Product Name	:	Vacuum Cleaner
Model Name	:	ZK902A
Additional model	:	ZK902B,ZK902C,ZK902D,ZK902E,ZK902F,ZK902G,ZK902H,ZK902J, ZK902K,ZK902L,ZK902M,ZK902N,ZK902P,ZK902Q,ZK902R,ZK902T, ZK902U,ZK902V,ZK902W Note:The appearance of the product is different in color , and the PCB board is the same. So choose ZK902A as the main test model
Operation Frequency	:	5745MHz~5825MHz
Number of Channel	:	5 Channels for 802.11a 5 Channels for 802.11n(HT20) 5 Channels for 802.11ac(HT20) 2 Channels for 802.11n(HT40) 2 Channels for 802.11ac(HT40) 1 Channels for 802.11ac(HT80)
Type of Modulation	:	OFDM with BPSK/QPSK/16QAM/64QAM/256QAM
Antenna installation	:	PIFA Antenna
Antenna Gain	:	3.0dBi
The directional gain	:	6.01dBi
Power supply	:	Input:AC100-240V,50/60Hz, 0.8A Output : DC 24V-1A
Hardware Version	:	VER 1.2
Software Version	:	N/A



3.1 Channel List

802.11a/n20/ac20

Channel	Freq. (MHz)	Channel	Freq. (MHz)
149	5745	153	5765
157	5785	161	5805
165	5825		

802.11n40/ac40

Channel	Freq. (MHz)	Channel	Freq. (MHz)
151	5755	159	5795

802.11ac80

Channel	Freq. (MHz)
155	5775

3.2 Test Site

Precise Testing & Certification Co., Ltd.

Building 1, No. 6, Tongxin Road, Dongcheng Street, Dongguan, Guangdong, China

FCC Registration Number: 790290

A2LA Certificate No.: 4408.01

IC Registration Number: 12191A-1



4 Equipment During Test

4.1 Equipments List

RF Conducted Test

Name of Equipment	Manufacturer	Model	Serial No.	Characteristics	Calibration Due
MXG Signal Analyzer	Agilent	N9020A	SER MY5111038	10Hz-30GHz	Aug. 21, 2021
Coaxial Cable	CDS	79254	46107086	10Hz-30GHz	Aug. 21, 2021
Power Meter	Anritsu	ML2495A	0949003	300MHz-40GHz	Aug. 21, 2021
Power Sensor	Anritsu	MA2411B	0917017	300MHz-40GHz	Aug. 21, 2021

Remark: The temporary antenna connector is soldered on the PCB board in order to perform conducted tests and this temporary antenna connector is listed in the equipment list.

Radiated Emissions

Name of Equipment	Manufacturer	Model	Serial No.	Characteristics	Calibration Due
EMI Test Receiver	Rohde&Schwarz	ESCI	101417	9KHz-3GHz	Aug. 21, 2021
Loop Antenna	Schwarzbeck	FMZB 1519	012	9 KHz -30MHz	Aug. 21, 2021
Bilog Antenna	SCHWARZBECK	VULB9160	9160-3355	25MHz-2GHz	Aug. 21, 2021
Preamplifier (low frequency)	SCHWARZBECK	BBV 9475	9745-0013	1MHz-1GHz	Aug. 21, 2021
Cable	Schwarzbeck	PLF-100	549489	9KHz-3GHz	Aug. 21, 2021
Spectrum Analyzer	Agilent	E4407B	MY45109572	9KHz-40GHz	Aug. 21, 2021
Horn Antenna	SCHWARZBECK	9120D	9120D-1246	1GHz-18GHz	Aug. 21, 2021
Power Amplifier	LUNAR EM	LNA1G18-40	J10100000081	1GHz-26.5GHz	Aug. 21, 2021
Horn Antenna	SCHWARZBECK	BBHA 9170	9170-181	14GHz-40GHz	Aug. 21, 2021
Amplifier	SCHWARZBECK	BBV 9721	9721-205	18GHz-40GHz	Aug. 21, 2021
Cable	H+S	CBL-26	N/A	1GHz-26.5GHz	Aug. 21, 2021



RF Cable	R&S	R204	R21X	1GHz-40GHz	Aug. 21, 2021
----------	-----	------	------	------------	---------------

Conducted Emissions

Name of Equipment	Manufacturer	Model	Serial No.	Characteristics	Calibration Due
EMI Test Receiver	Rohde&Schwarz	ESCI	101417	9KHz-3GHz	Aug. 21, 2021
Artificial Mains Network	Rohde&Schwarz	ENV216	102453	9KHz-300MHz	Aug. 21, 2021
Artificial Mains Network	Rohde&Schwarz	ENV216	101342	9KHz-300MHz	Aug. 21, 2021

4.2 Measurement Uncertainty

Radiation Uncertainty	:	Ur = 3.9 dB (Horizontal)
		Ur = 3.8 dB (Vertical)
Conduction Uncertainty	:	Uc = 3.4 dB

4.3 Description of Support Units

Equipment	Model No.	Series No.
N/A	Input: AC 100-240V, 50-60Hz Output: DC 24V, 1A,	N/A

5 Conducted Emission Test

5.1 Test Standard and Limit

Test Standard	FCC Part15 Section 15.207&15.407		
Test Limit	Frequency	Maximum RF Line Voltage (dBuV)	
		Quasi-peak Level	Average Level
	150kHz~500kHz	66 ~ 56 *	56 ~ 46 *
	500kHz~5MHz	56	46
	5MHz~30MHz	60	50
Remark: (1) *Decreasing linearly with logarithm of the frequency. (2) The lower limit shall apply at the transition frequency.			

5.2 Test Setup

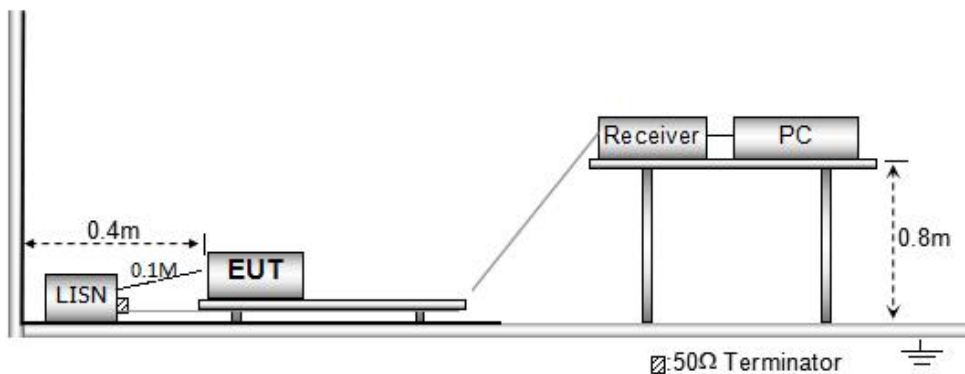

5.3 Test Procedure

The EUT system is connected to the power mains through a line impedance stabilization network (L.I.S.N.). This provides a 50ohm coupling impedance for the EUT system. Please refer the block diagram of the test setup and photographs. Both sides of AC line are checked to find out the maximum conducted emission. In order to find the maximum emission levels, the relative positions of equipment and all of the interface cables shall be changed according to FCC ANSI C63.10-2013 on Conducted Emission Measurement.

The bandwidth of test receiver (ESCI) set at 9kHz.

The frequency range from 150kHz to 30MHz is checked.



5.4 Test Data

Note: All adapters have been tested, and the worst adapter data in the report: K25V240100U.

Conducted Emission Test Data

Operating Condition: 802.11ac80 CH 155
 Test Specification: AC 120V/60Hz
 Comment: Live Line
 Tem.: 23.1°C Hum.: 54.6%

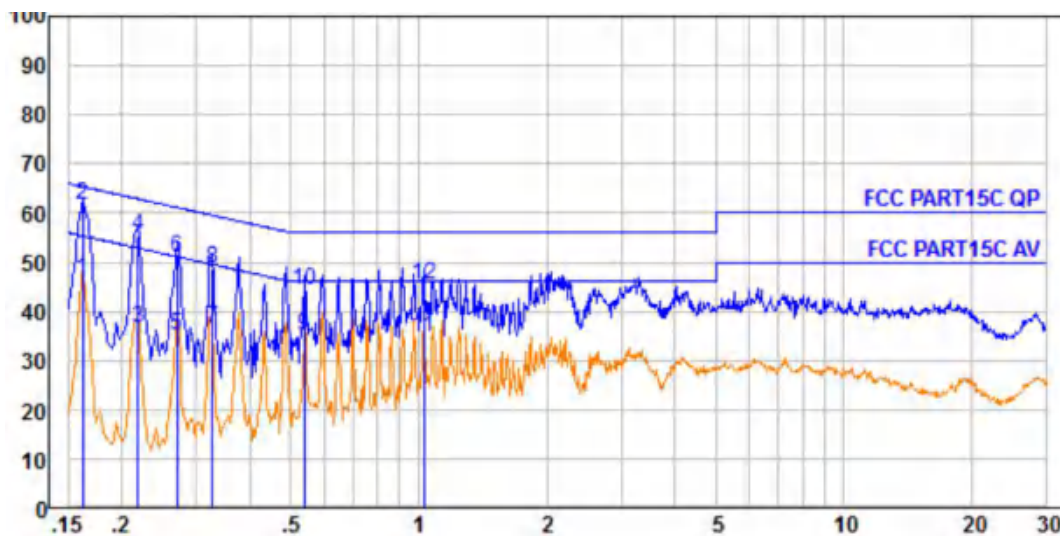

No.	Freq MHz	Cable Loss dB	AMN Factor dB	Receiver Reading dBµV	Emission Level dBµV	Limit dBµV	Over Limit dB	Remark
1.	0.162	0.23	9.59	36.77	46.59	55.34	-8.75	Average
2.	0.162	0.23	9.59	51.78	61.60	65.34	-3.74	QP
3.	0.219	0.30	9.59	26.73	36.62	52.88	-16.26	Average
4.	0.219	0.30	9.59	45.50	55.39	62.88	-7.49	QP
5.	0.270	0.35	9.60	25.08	35.03	51.12	-16.09	Average
6.	0.270	0.35	9.60	41.13	51.08	61.12	-10.04	QP
7.	0.327	0.38	9.60	26.50	36.48	49.53	-13.05	Average
8.	0.327	0.38	9.60	38.55	48.53	59.53	-11.00	QP
9.	0.538	0.43	9.61	25.13	35.17	46.00	-10.83	Average
10.	0.538	0.43	9.61	34.17	44.21	56.00	-11.79	QP
11.	1.027	0.46	9.61	24.73	34.80	46.00	-11.20	Average
12.	1.027	0.46	9.61	35.49	45.56	56.00	-10.44	QP



Conducted Emission Test Data

Operating Condition: 802.11ac80 CH 155
 Test Specification: AC 120V/60Hz
 Comment: Neutral Line
 Tem.: 23.1°C Hum.: 54.6%

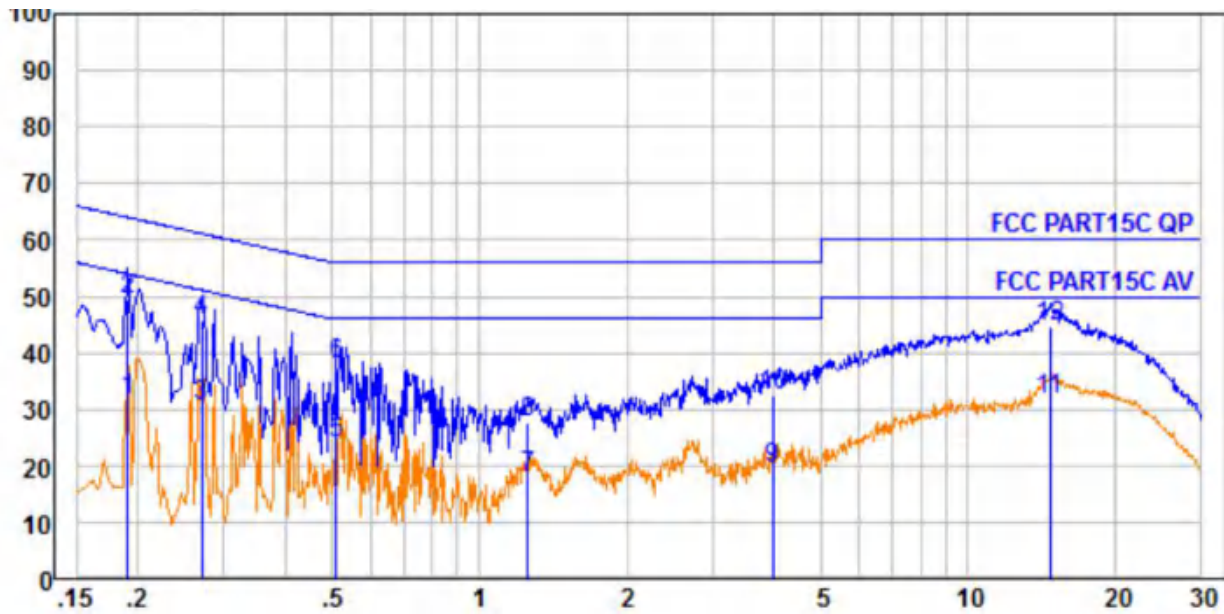

No.	Freq MHz	Cable Loss dB	AMN Factor dB	Receiver Reading dBμV	Emission Level dBμV	Limit dBμV	Over Limit dB	Remark
1.	0.190	0.27	9.61	21.95	31.83	54.02	-22.19	Average
2.	0.190	0.27	9.61	39.44	49.32	64.02	-14.70	QP
3.	0.270	0.35	9.62	20.69	30.66	51.12	-20.46	Average
4.	0.270	0.35	9.62	35.64	45.61	61.12	-15.51	QP
5.	0.510	0.43	9.63	14.02	24.08	46.00	-21.92	Average
6.	0.510	0.43	9.63	27.83	37.89	56.00	-18.11	QP
7.	1.255	0.46	9.64	8.15	18.25	46.00	-27.75	Average
8.	1.255	0.46	9.64	17.69	27.79	56.00	-28.21	QP
9.	3.985	0.47	9.68	9.49	19.64	46.00	-26.36	Average
10.	3.985	0.47	9.68	22.34	32.49	56.00	-23.51	QP
11.	14.750	0.56	9.84	21.42	31.82	50.00	-18.18	Average
12.	14.750	0.56	9.84	34.13	44.53	60.00	-15.47	QP



6 . Radiation Spurious Emission and Band Edge

6.1 Test Standard and Limit

Test Standard	FCC Part15 C Section 15.209, 15.205 and 15.407				
Test Limit	Frequency (MHz)	Field strength (microvolt/meter)	Limit (dBuV/m)	Remark	Measurement distance (m)
	0.009MHz~0.490MHz	2400/F(kHz)	-	-	300
	0.490MHz-1.705MHz	24000/F(kHz)	-	-	30
	1.705MHz-30MHz	30	-	-	30
	30MHz~88MHz	100	40.0	Quasi-peak	3
	88MHz~216MHz	150	43.5	Quasi-peak	3
	216MHz~960MHz	200	46.0	Quasi-peak	3
	960MHz~1000MHz	500	54.0	Quasi-peak	3
	Above 1000MHz	500	54.0	Average	3
		-	68.2	Peak	3

Remark:

(1)The lower limit shall apply at the transition frequency.

(2) 15.35(b), Unless otherwise specified, the limit on peak radio frequency emissions is 20dB above the maximum permitted average emission limit applicable to the equipment under test. This peak limit applies to the total peak emission level radiated by the device.

(3)Above 1GHz limit: $E[dBuV/m] = EIRP[dBm] + 95.2=68.2 dBuV/m$, for $EIPR[dBm]=-27dBm$.

6.2 Test Setup

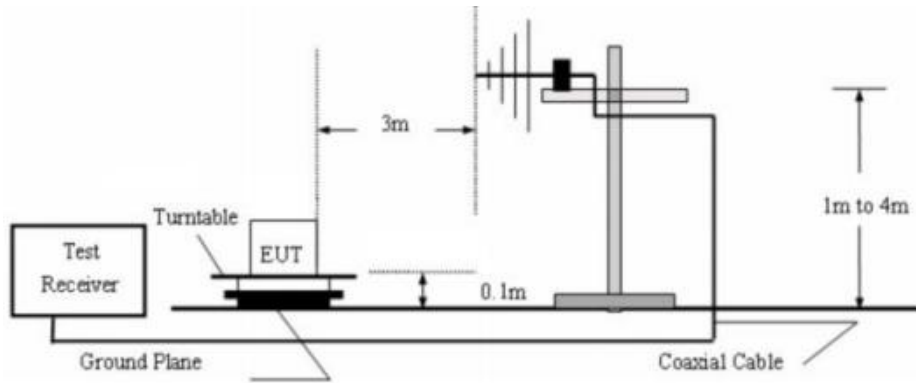

Figure 1. Below 30MHz

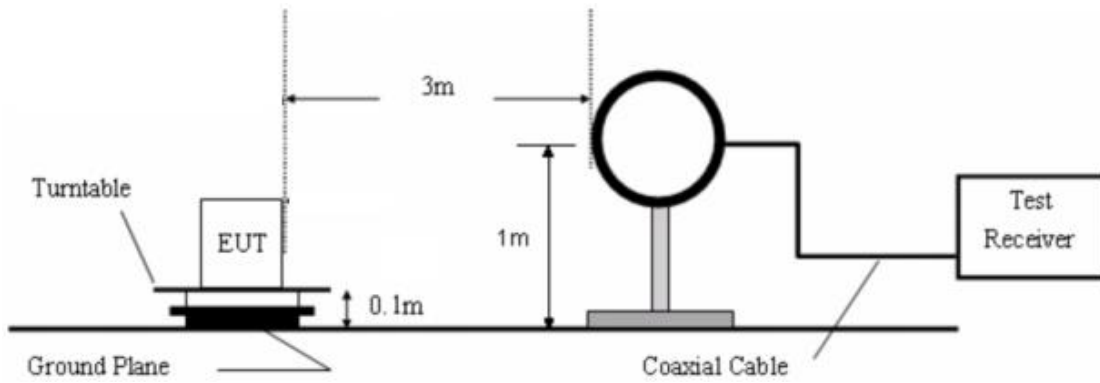

Figure 2. 30MHz to 1GHz

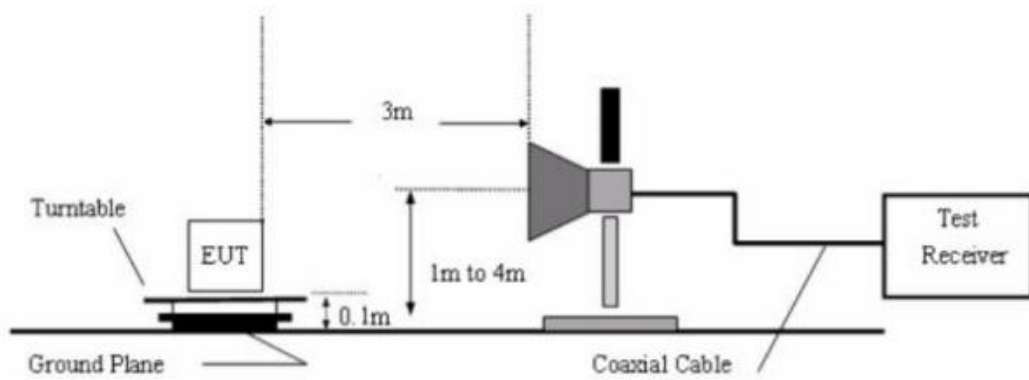

Figure 3. Above 1 GHz



6.3 Test Procedure

For below 1GHz: The EUT is placed on a turntable, which is 0.1m above the ground plane.

For above 1GHz: The EUT is placed on a turntable, which is 1.5m above the ground plane.

The turn table can rotate 360 degrees to determine the position of the maximum emission level. The EUT is set 3 meters away from the receiving antenna which is mounted on a antenna tower. The antenna can be moved up and down from 1 to 4 meters to find out the maximum emission level. Rotated the EUT through three orthogonal axes to determine the maximum emissions, both horizontal and vertical polarization of the antenna are set on test. The EUT is tested in 9*6*6 Chamber. The device is evaluated in xyz orientation.

For the radiated emission test above 1GHz:

Place the measurement antenna away from each area of the EUT determined to be a source of emissions at the specified measurement distance, while keeping the measurement antenna aimed at the source of emissions at each frequency of significant emissions, with polarization oriented for maximum response. The measurement antenna may have to be higher or lower than the EUT, depending on the radiation pattern of the emission and staying aimed at the emission source for receiving the maximum signal. The final measurement antenna elevation shall be that which maximizes the emissions. The measurement antenna elevation for maximum emissions shall be restricted to a range of heights of from 1 m to 4 m above the ground or reference ground plane.

For 9kHz to 150kHz, Set the spectrum analyzer as:

RBW = 200Hz, VBW =1kHz, Detector= Quasi-Peak, Trace mode= Max hold, Sweep- auto couple.

For 150kHz to 30MHz, Set the spectrum analyzer as:

RBW = 9KHz, VBW =30kHz, Detector= Quasi-Peak, Trace mode= Max hold, Sweep- auto couple.

For 30MHz to 1000MHz, Set the spectrum analyzer as:

RBW = 100kHz, VBW =300kHz, Detector= Quasi-Peak, Trace mode= Max hold, Sweep- auto couple.

For above 1GHz, Set the spectrum analyzer as:

RBW =1MHz, VBW =1MHz, Detector= Peak, Trace mode= Max hold, Sweep- auto couple.

RBW =1MHz, VBW =10Hz, Detector= Average, Trace mode= Max hold, Sweep- auto couple.



6.4 Test Data

PASS

The test results of 9kHz-30MHz was attenuated more than 20dB below the permissible limits, so the results don't record in the report.

During the test, pre-scan all modes, and found MIMO mode is the worst case and only the worst case is recorded in the report.

All adapters have been tested, and the worst adapter data in the report: K25V240100U.



Test Results (30~1000MHz)

Temp.(°C)/Hum.(%RH): 24.3°C/51%

Test Mode: TX Mode

Power Source: DC 24V

Polarization: Horizontal

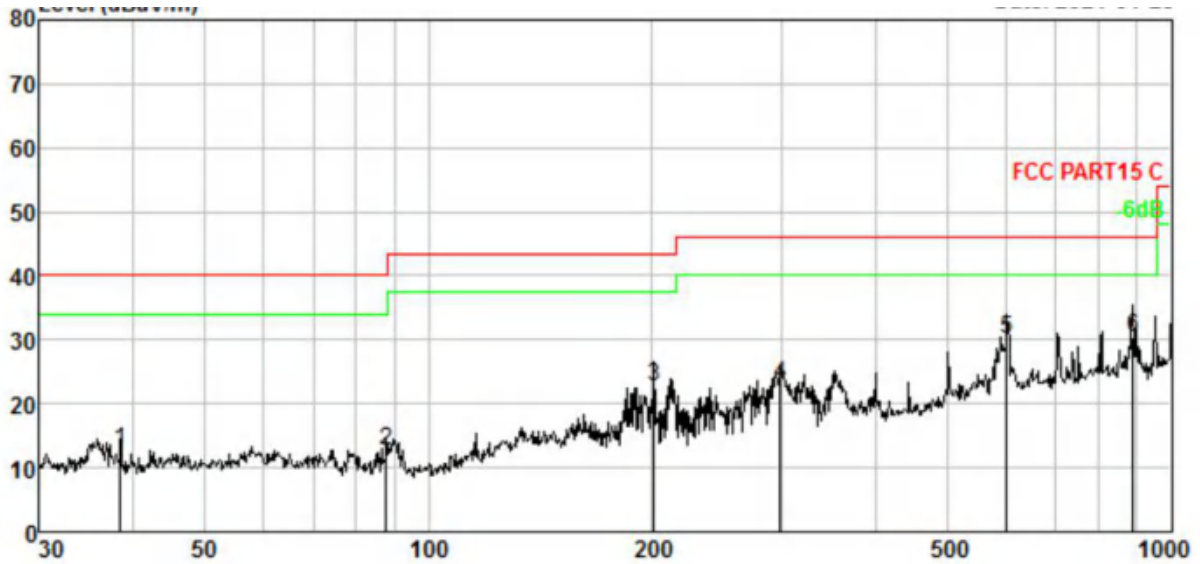

No.	Freq MHz	Cable Loss dB	ANT Factor dB/m	Receiver Reading dBuV	Preamp Factor dB	Emission Level dBuV/m	Limit dBuV/m	Over Limit dB	Remark
1.	38.481	1.63	12.13	28.74	29.91	12.59	40.00	-27.41	QP
2.	87.725	3.05	8.98	30.62	29.98	12.67	40.00	-27.33	QP
3.	201.393	4.47	11.05	37.21	30.04	22.69	43.50	-20.81	QP
4.	298.268	5.15	13.18	35.02	30.32	23.03	46.00	-22.97	QP
5.	601.427	6.35	18.73	35.90	31.01	29.97	46.00	-16.03	QP
6.	887.610	7.03	21.98	32.35	31.06	30.30	46.00	-15.70	QP



Test Results (30~1000MHz)

Temp.(°C)/Hum.(%RH): 24.3°C/51% Test Mode: TX Mode
 Power Source: DC 24V Polarization: Vertical

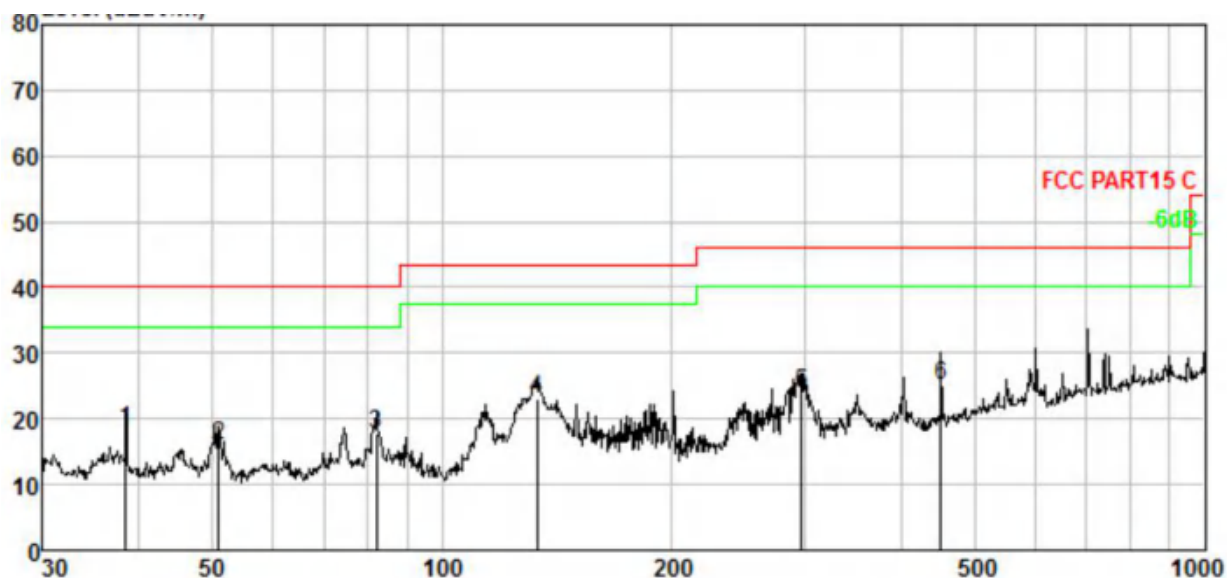

No.	Freq MHz	Cable Loss dB	ANT Factor dB/m	Receiver Reading dBuV	Preamp Factor dB	Emission Level dBuV/m	Limit dBuV/m	Over Limit dB	Remark
1.	38.481	1.63	12.13	34.38	29.91	18.23	40.00	-21.77	QP
2.	50.942	2.11	12.10	31.72	29.92	16.01	40.00	-23.99	QP
3.	82.071	2.93	8.87	36.01	29.97	17.84	40.00	-22.16	QP
4.	133.151	3.77	12.88	36.53	30.01	23.17	43.50	-20.33	QP
5.	296.184	5.14	13.15	35.87	30.31	23.85	46.00	-22.15	QP
6.	451.135	5.86	15.93	34.02	30.81	25.00	46.00	-21.00	QP



Test Results (Above 1000MHz)

ANT A:

Test mode:	IEEE 802.11a	Test channel:	Low CH
------------	--------------	---------------	--------

Peak value:

Frequency (MHz)	Read Level (dBuV)	Antenna Factor (dB/m)	Cable Loss (dB)	Preamp Factor (dB)	Level (dBuV/m)	Limit Line (dBuV/m)	Over Limit (dB)	Pol.
11490.00	40.24	31.98	17.08	33.91	55.39	68.20	-12.81	V
17235.00	39.68	32.65	20.03	34.85	57.51	68.20	-10.69	V
11490.00	41.99	31.98	17.08	33.91	57.14	68.20	-11.06	H
17235.00	40.92	32.65	20.03	34.85	58.75	68.20	-9.45	H

Average value:

Frequency (MHz)	Read Level (dBuV)	Antenna Factor (dB/m)	Cable Loss (dB)	Preamp Factor (dB)	Level (dBuV/m)	Limit Line (dBuV/m)	Over Limit (dB)	Pol.
11490.00	28.92	31.98	17.08	33.91	44.07	54.00	-9.93	V
17235.00	28.73	32.65	20.03	34.85	46.56	54.00	-7.44	V
11490.00	29.16	31.98	17.08	33.91	44.31	54.00	-9.69	H
17235.00	27.72	32.65	20.03	34.85	45.55	54.00	-8.45	H

Test mode:	IEEE 802.11a	Test channel:	Mid CH
------------	--------------	---------------	--------

Peak value:

Frequency (MHz)	Read Level (dBuV)	Antenna Factor (dB/m)	Cable Loss (dB)	Preamp Factor (dB)	Level (dBuV/m)	Limit Line (dBuV/m)	Over Limit (dB)	Pol.
11570.00	39.84	32.44	17.18	33.91	55.55	68.20	-12.65	V
17355.00	40.70	32.78	20.12	34.86	58.74	68.20	-9.46	V
11570.00	41.67	32.44	17.18	33.91	57.38	68.20	-10.82	H
17355.00	41.90	32.78	20.12	34.86	59.94	68.20	-8.26	H



Average value:

Frequency (MHz)	Read Level (dBuV)	Antenna Factor (dB/m)	Cable Loss (dB)	Preamp Factor (dB)	Level (dBuV/m)	Limit Line (dBuV/m)	Over Limit (dB)	Pol.
11570.00	27.38	32.44	17.18	33.91	43.09	54.00	-10.91	V
17355.00	27.87	32.78	20.12	34.86	45.91	54.00	-8.09	V
11570.00	27.13	32.44	17.18	33.91	42.84	54.00	-11.16	H
17355.00	27.30	32.78	20.12	34.86	45.34	54.00	-8.66	H

Test mode:	IEEE 802.11a	Test channel:	High CH
------------	--------------	---------------	---------

Peak value:

Frequency (MHz)	Read Level (dBuV)	Antenna Factor (dB/m)	Cable Loss (dB)	Preamp Factor (dB)	Level (dBuV/m)	Limit Line (dBuV/m)	Over Limit (dB)	Pol.
11650.00	39.70	32.59	18.02	33.92	56.39	68.20	-11.81	V
17475.00	39.88	32.87	20.15	34.88	58.02	68.20	-10.18	V
11650.00	41.55	32.59	18.02	33.92	58.24	68.20	-9.96	H
17475.00	41.70	32.87	20.15	34.88	59.84	68.20	-8.36	H

Average value:

Frequency (MHz)	Read Level (dBuV)	Antenna Factor (dB/m)	Cable Loss (dB)	Preamp Factor (dB)	Level (dBuV/m)	Limit Line (dBuV/m)	Over Limit (dB)	Pol.
11650.00	27.45	32.59	18.02	33.92	44.14	54.00	-9.86	V
17475.00	27.26	32.87	20.15	34.88	45.40	54.00	-8.60	V
11650.00	28.39	32.59	18.02	33.92	45.08	54.00	-8.92	H
17475.00	27.03	32.87	20.15	34.88	45.17	54.00	-8.83	H

Note:

1. Final Level =Receiver Read level + Antenna Factor + Cable Loss–Preamplifier Factor



Band Edge test:

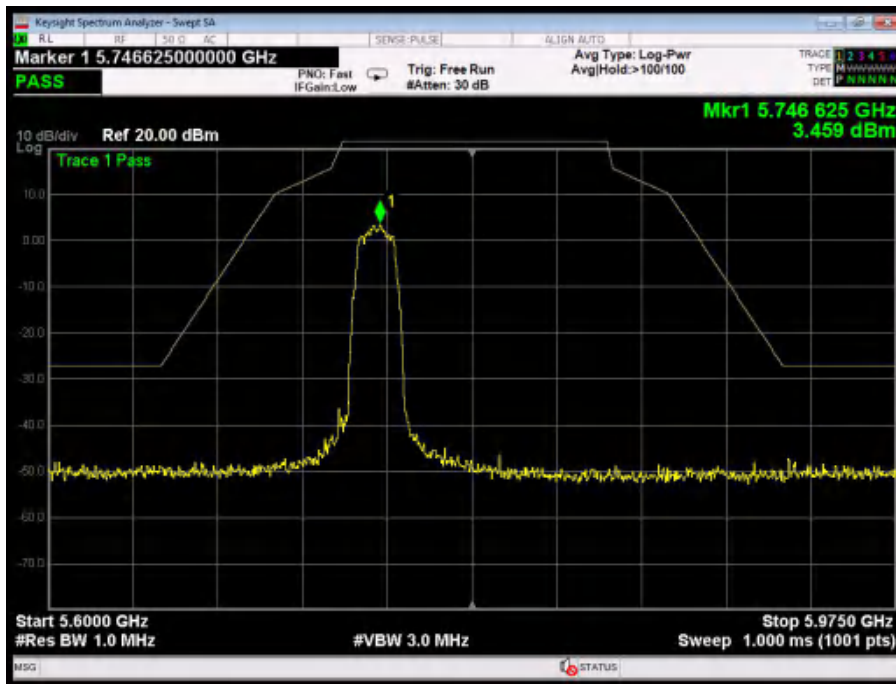

802.11a: Band Edge, Left Side

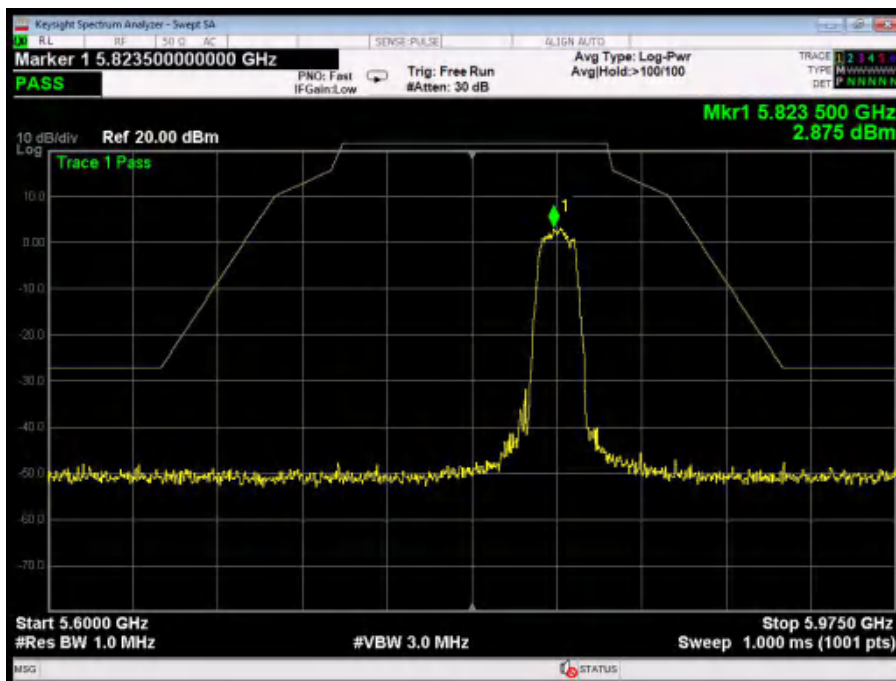

802.11a: Band Edge, Right Side

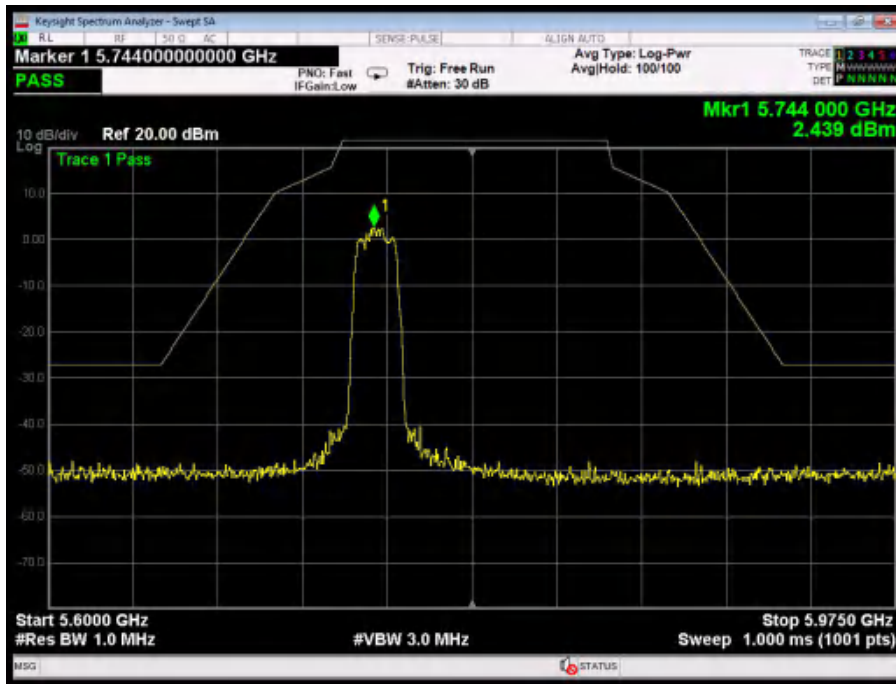

802.11n(20): Band Edge, Left Side

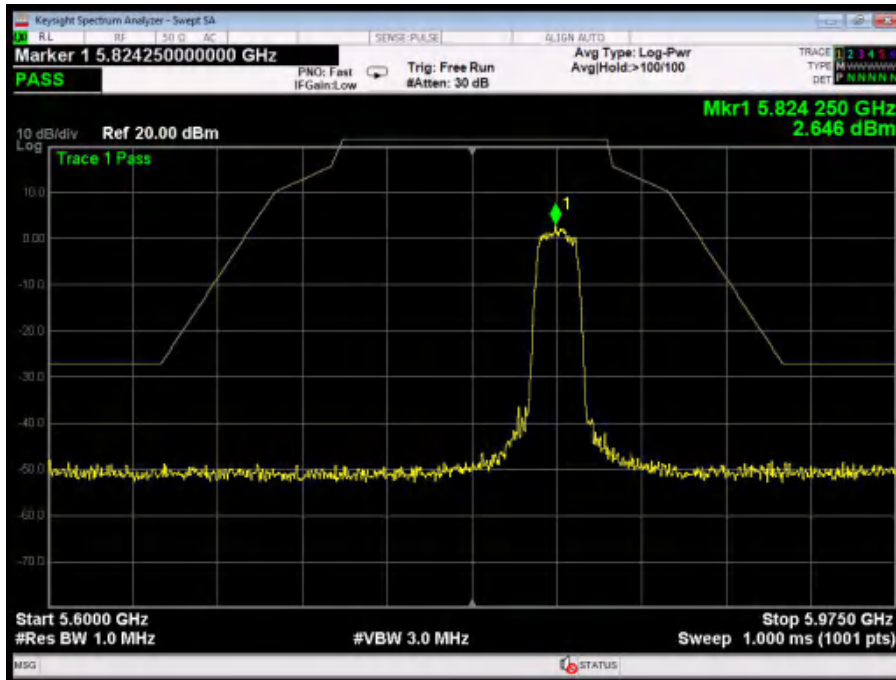

802.11n(20): Band Edge, Right Side

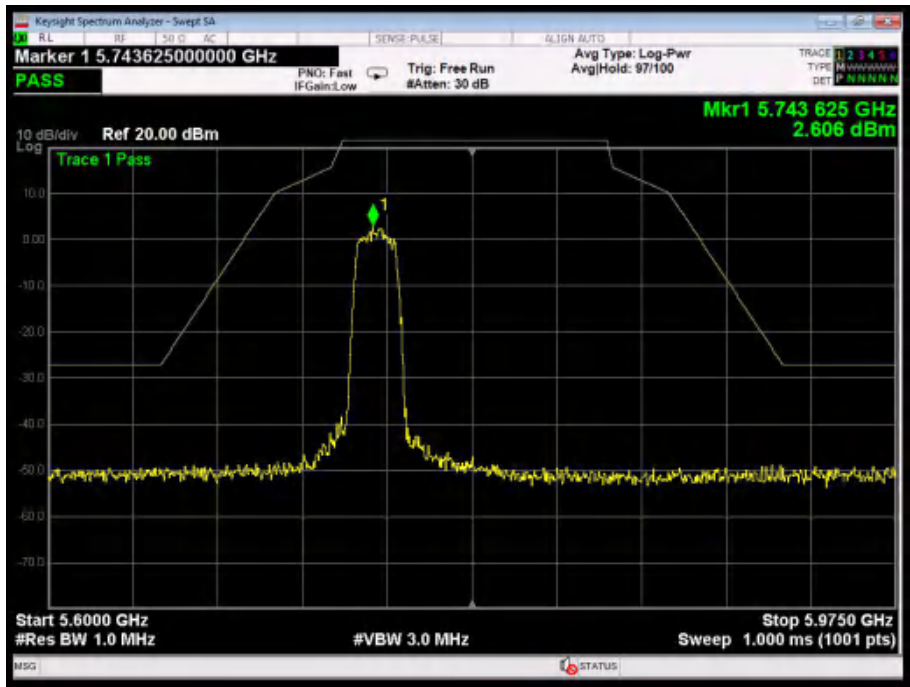

802.11ac(20): Band Edge, Left Side

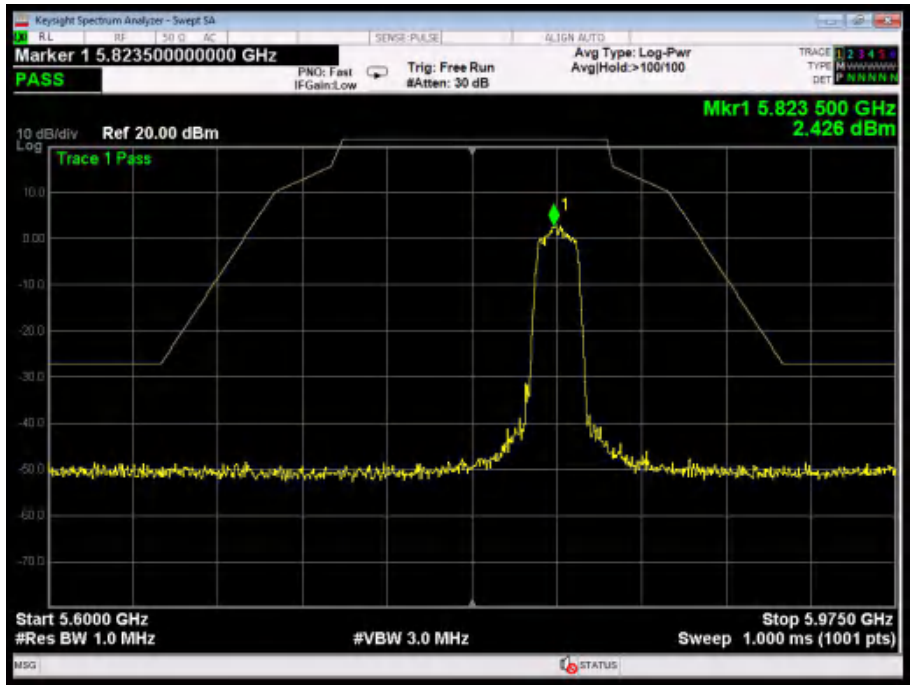

802.11ac(20): Band Edge, Right Side

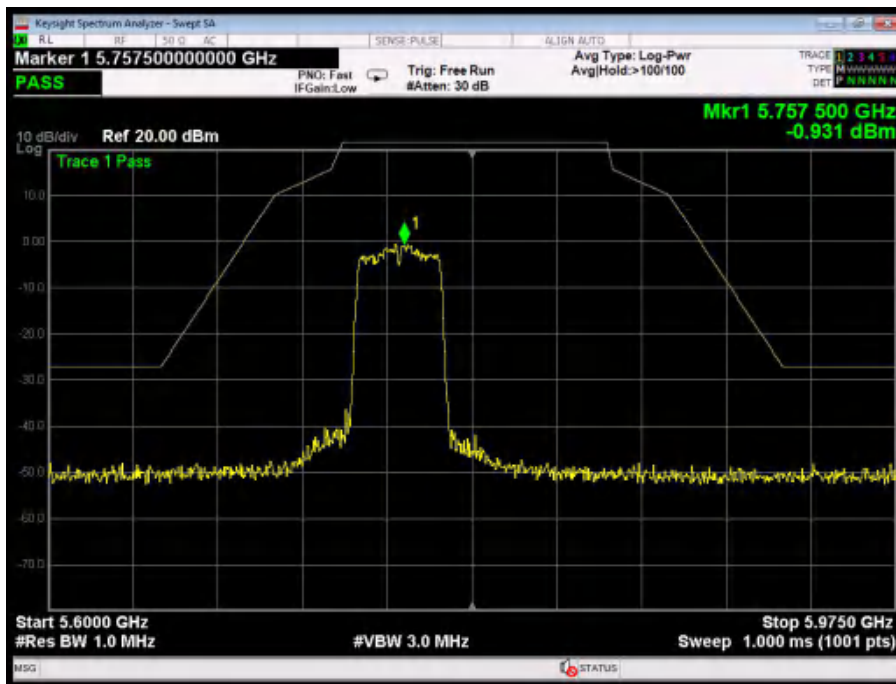

802.11n(40): Band Edge, Left Side

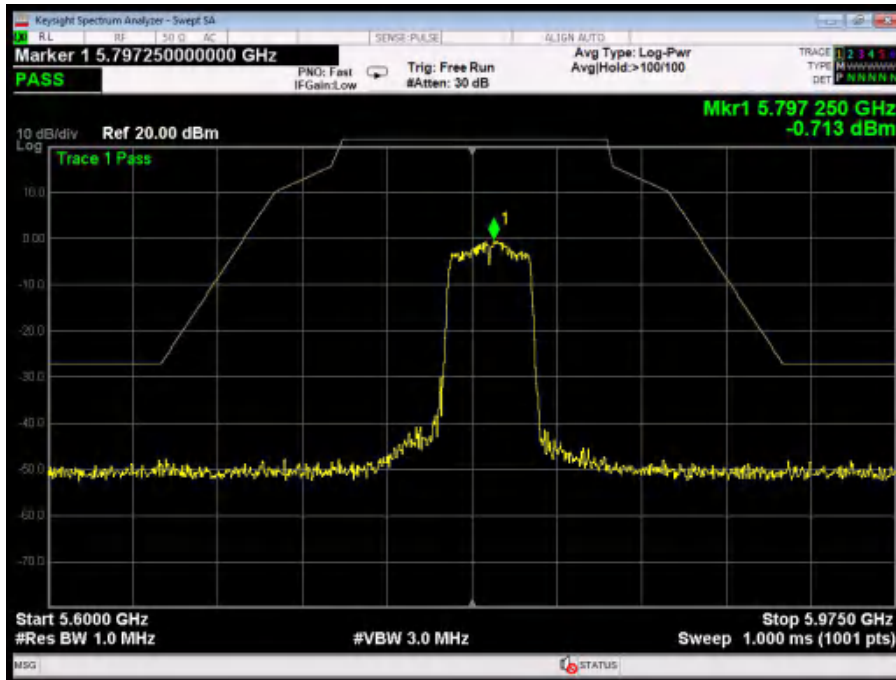

802.11n(40): Band Edge, Right Side

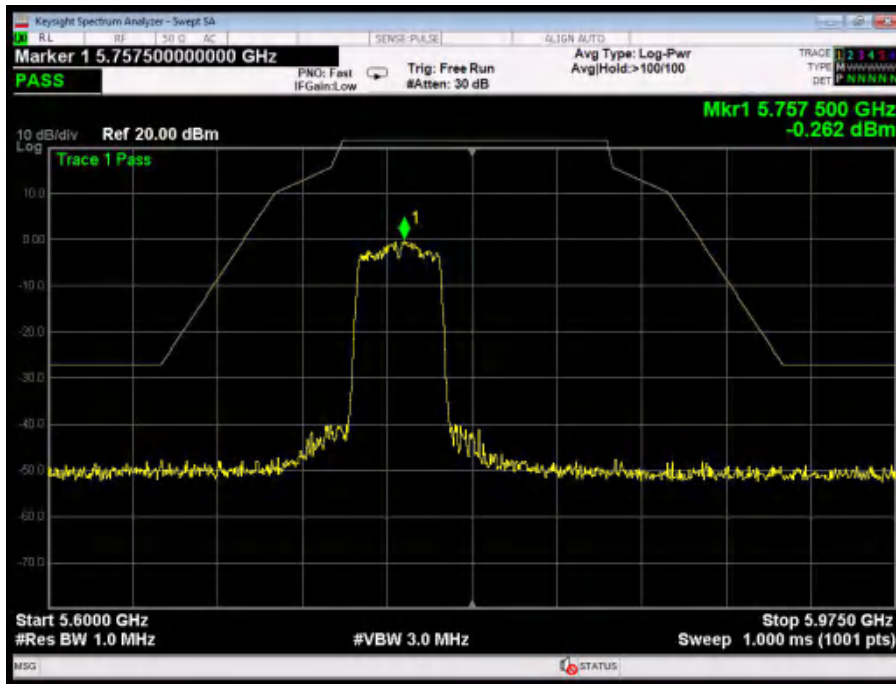

802.11ac(40): Band Edge, Left Side

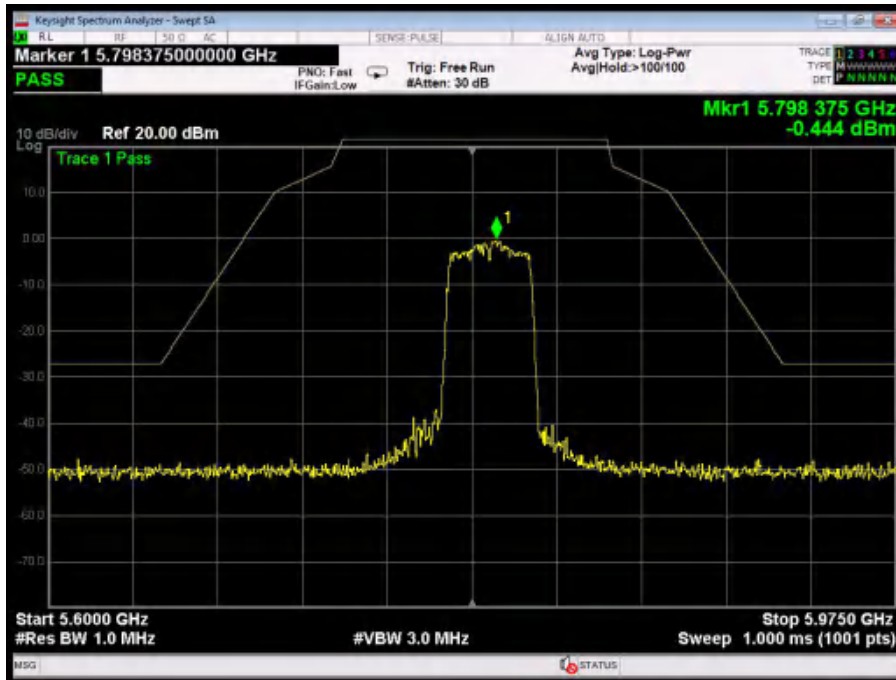

802.11ac(40): Band Edge, Right Side

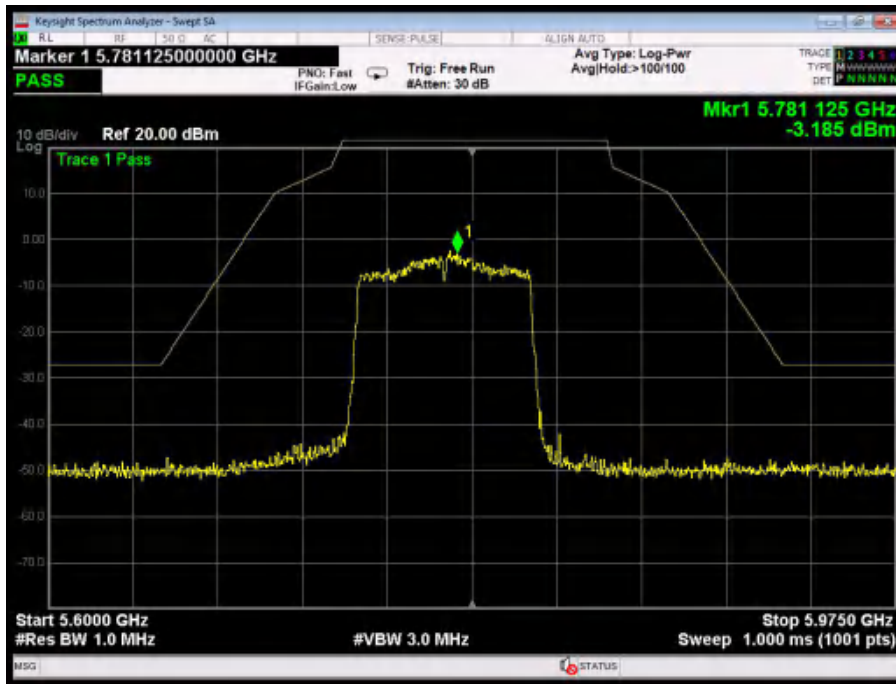

802.11ac(80): Band Edge



Test Results (Above 1000MHz)

ANT B:

Test mode:	IEEE 802.11a	Test channel:	Low CH
------------	--------------	---------------	--------

Peak value:

Frequency (MHz)	Read Level (dBuV)	Antenna Factor (dB/m)	Cable Loss (dB)	Preamplifier Factor (dB)	Level (dBuV/m)	Limit Line (dBuV/m)	Over Limit (dB)	Pol.
11490.00	41.93	31.98	17.08	33.91	57.08	68.20	-11.12	V
17235.00	40.88	32.65	20.03	34.85	58.71	68.20	-9.49	V
11490.00	41.64	31.98	17.08	33.91	56.79	68.20	-11.41	H
17235.00	39.70	32.65	20.03	34.85	57.53	68.20	-10.67	H

Average value:

Frequency (MHz)	Read Level (dBuV)	Antenna Factor (dB/m)	Cable Loss (dB)	Preamplifier Factor (dB)	Level (dBuV/m)	Limit Line (dBuV/m)	Over Limit (dB)	Pol.
11490.00	27.75	31.98	17.08	33.91	42.90	54.00	-11.10	V
17235.00	27.18	32.65	20.03	34.85	45.01	54.00	-8.99	V
11490.00	29.26	31.98	17.08	33.91	44.41	54.00	-9.59	H
17235.00	27.54	32.65	20.03	34.85	45.37	54.00	-8.63	H

Test mode:	IEEE 802.11a	Test channel:	Mid CH
------------	--------------	---------------	--------

Peak value:

Frequency (MHz)	Read Level (dBuV)	Antenna Factor (dB/m)	Cable Loss (dB)	Preamplifier Factor (dB)	Level (dBuV/m)	Limit Line (dBuV/m)	Over Limit (dB)	Pol.
11570.00	41.57	32.44	17.18	33.91	57.28	68.20	-10.92	V
17355.00	39.59	32.78	20.12	34.86	57.63	68.20	-10.57	V
11570.00	41.60	32.44	17.18	33.91	57.31	68.20	-10.89	H
17355.00	41.37	32.78	20.12	34.86	59.41	68.20	-8.79	H



Average value:

Frequency (MHz)	Read Level (dBuV)	Antenna Factor (dB/m)	Cable Loss (dB)	Preamp Factor (dB)	Level (dBuV/m)	Limit Line (dBuV/m)	Over Limit (dB)	Pol.
11570.00	27.33	32.44	17.18	33.91	43.04	54.00	-10.96	V
17355.00	29.75	32.78	20.12	34.86	47.79	54.00	-6.21	V
11570.00	28.03	32.44	17.18	33.91	43.74	54.00	-10.26	H
17355.00	29.35	32.78	20.12	34.86	47.39	54.00	-6.61	H

Test mode:	IEEE 802.11a	Test channel:	High CH
------------	--------------	---------------	---------

Peak value:

Frequency (MHz)	Read Level (dBuV)	Antenna Factor (dB/m)	Cable Loss (dB)	Preamp Factor (dB)	Level (dBuV/m)	Limit Line (dBuV/m)	Over Limit (dB)	Pol.
11650.00	39.71	32.59	18.02	33.92	56.40	68.20	-11.80	V
17475.00	41.44	32.87	20.15	34.88	59.58	68.20	-8.62	V
11650.00	41.58	32.59	18.02	33.92	58.27	68.20	-9.93	H
17475.00	40.95	32.87	20.15	34.88	59.09	68.20	-9.11	H

Average value:

Frequency (MHz)	Read Level (dBuV)	Antenna Factor (dB/m)	Cable Loss (dB)	Preamp Factor (dB)	Level (dBuV/m)	Limit Line (dBuV/m)	Over Limit (dB)	Pol.
11650.00	27.40	32.59	18.02	33.92	44.09	54.00	-9.91	V
17475.00	28.87	32.87	20.15	34.88	47.01	54.00	-6.99	V
11650.00	29.59	32.59	18.02	33.92	46.28	54.00	-7.72	H
17475.00	29.91	32.87	20.15	34.88	48.05	54.00	-5.95	H

Note:

1. Final Level =Receiver Read level + Antenna Factor + Cable Loss–Preamplifier Factor



Band Edge test:

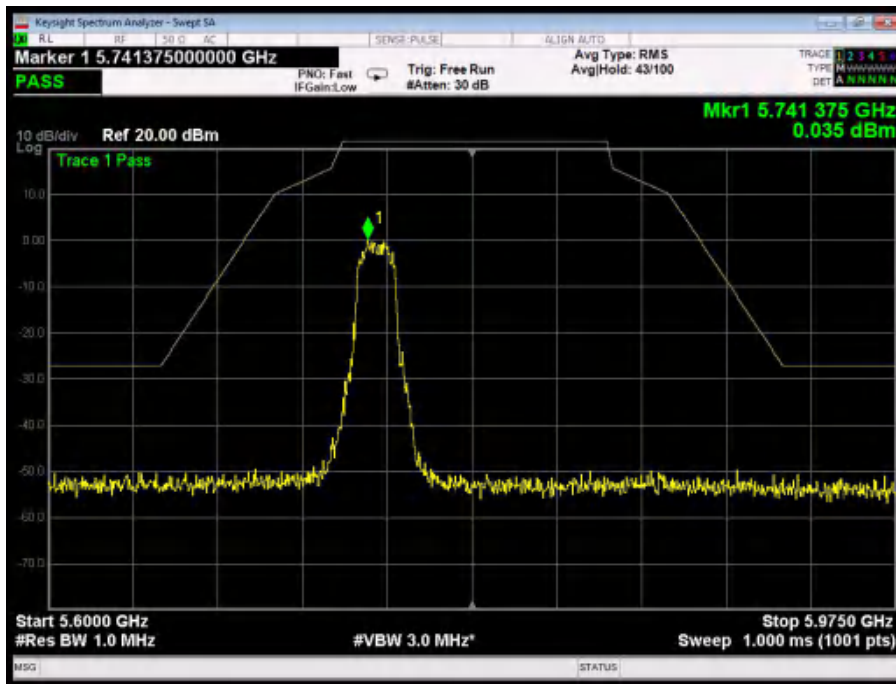

802.11a: Band Edge, Left Side

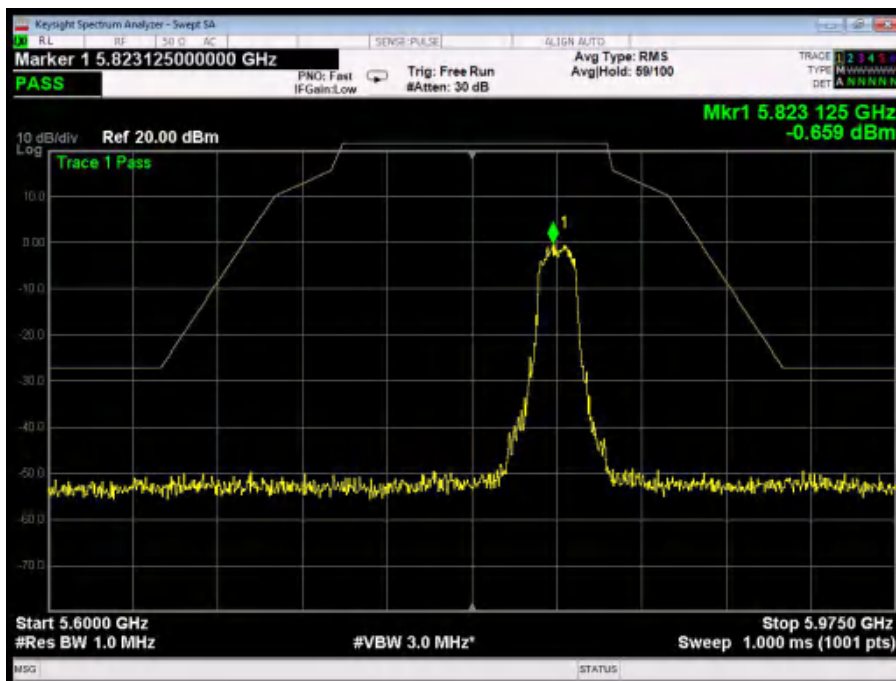

802.11a: Band Edge, Right Side

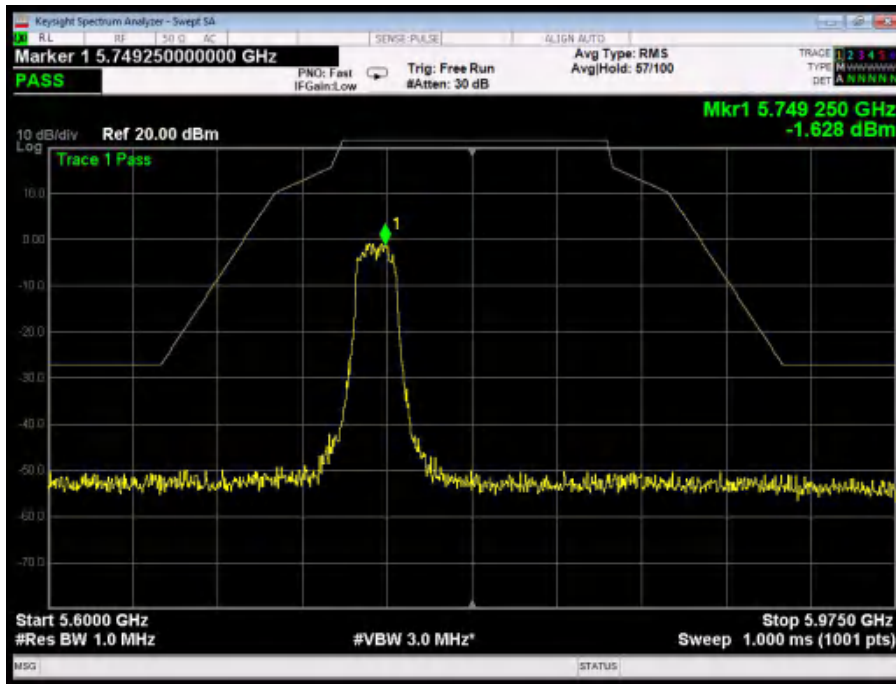

802.11n(20): Band Edge, Left Side

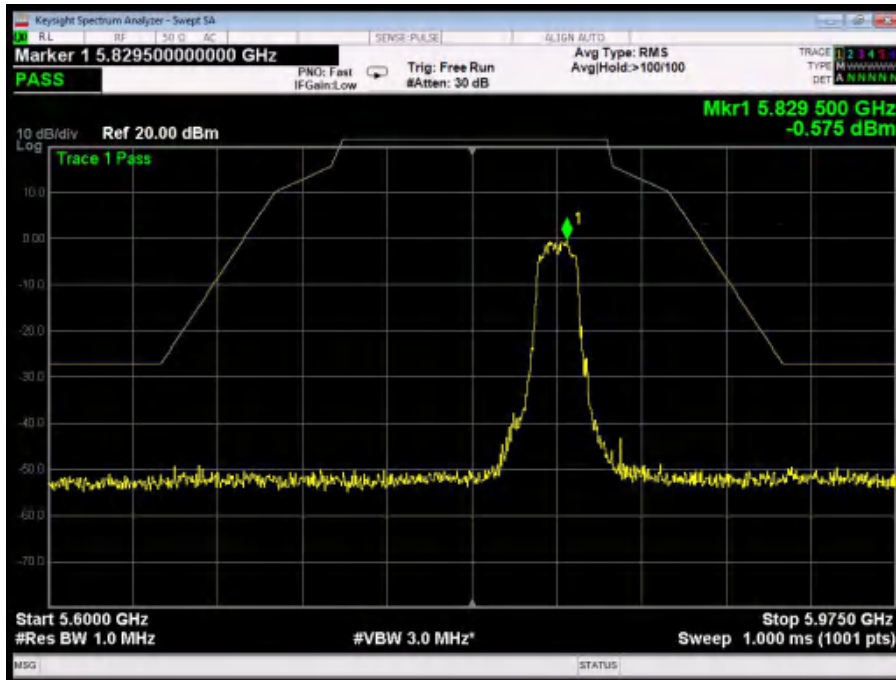

802.11n(20): Band Edge, Right Side

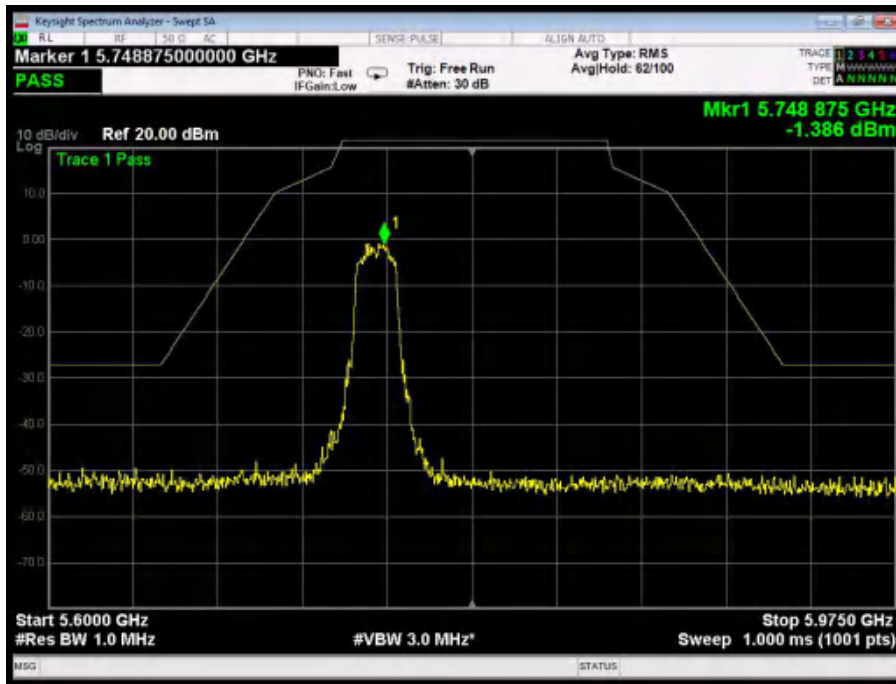

802.11ac(20): Band Edge, Left Side

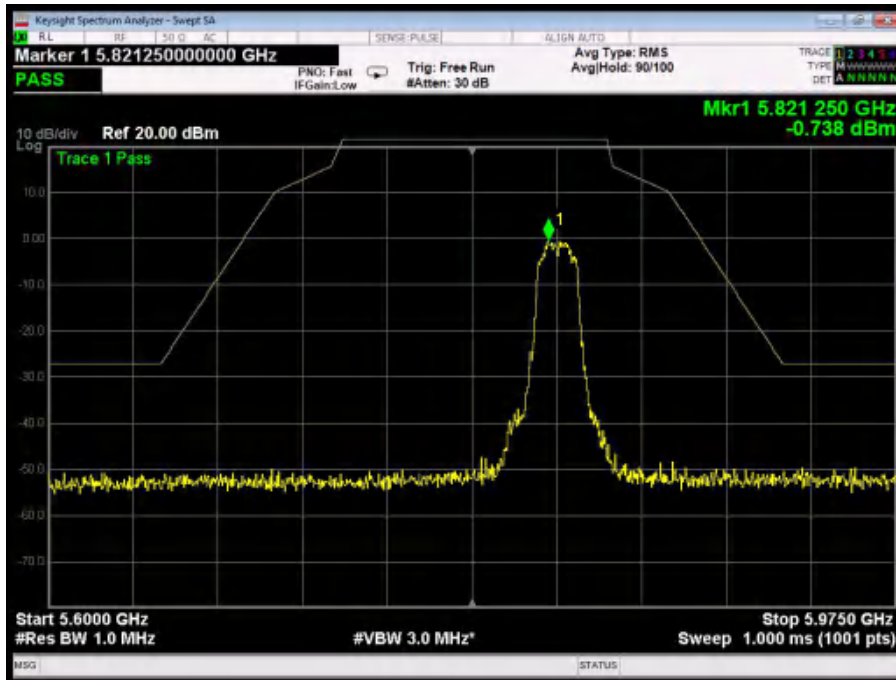

802.11ac(20): Band Edge, Right Side

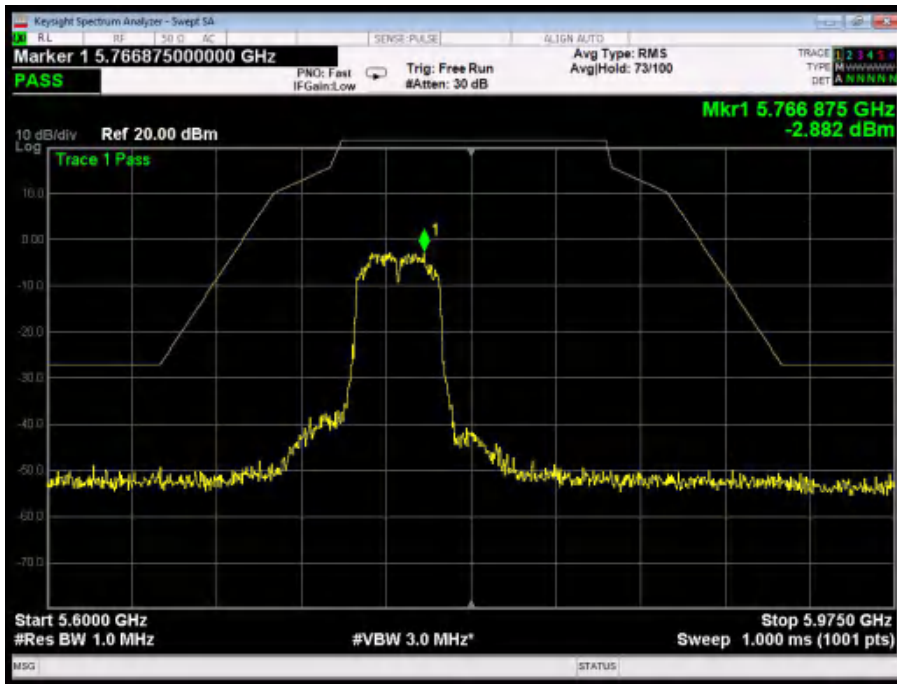

802.11n(40): Band Edge, Left Side

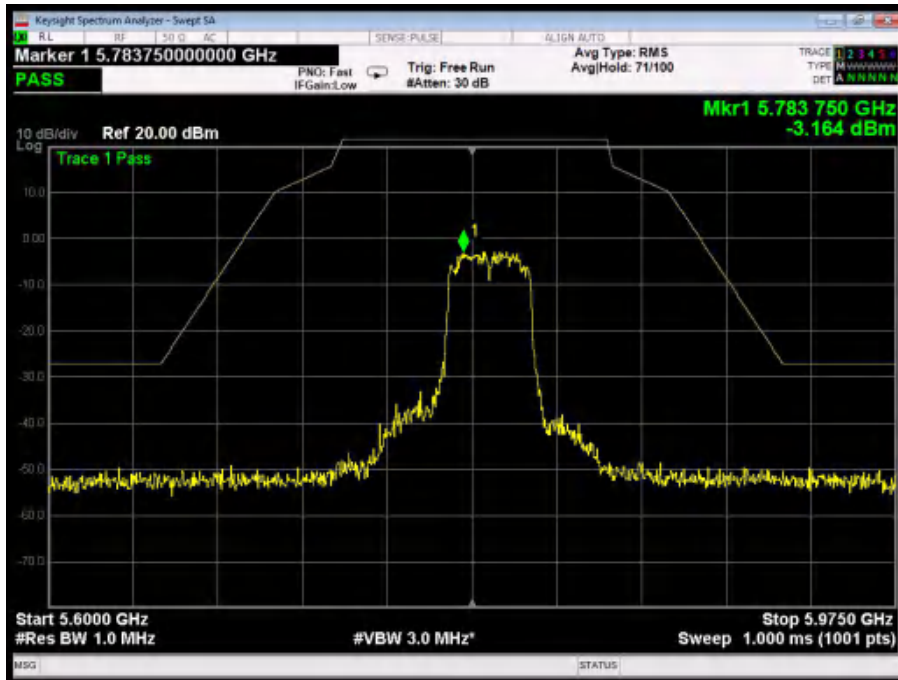

802.11n(40): Band Edge, Right Side

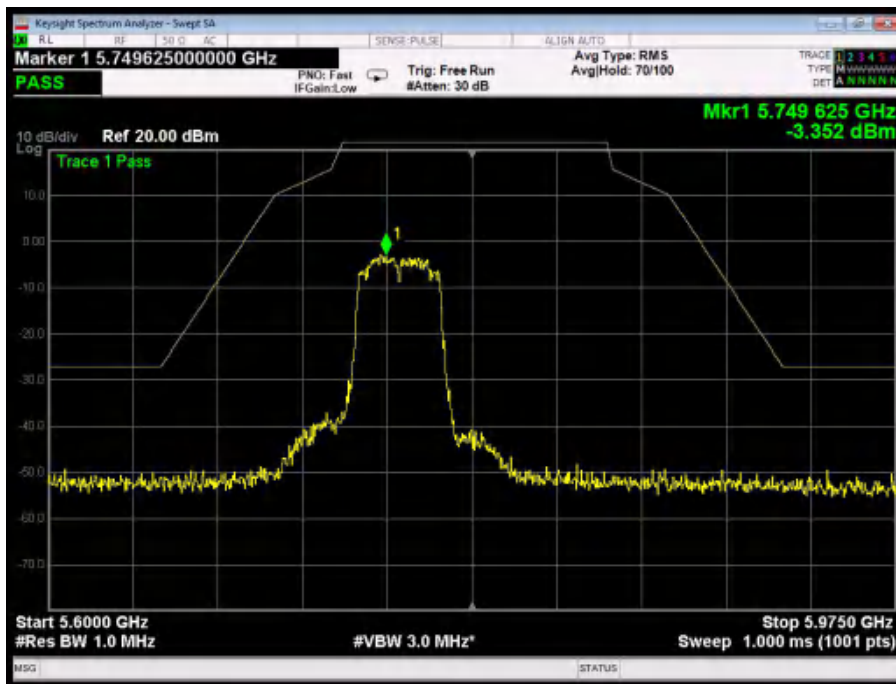

802.11ac(40): Band Edge, Left Side

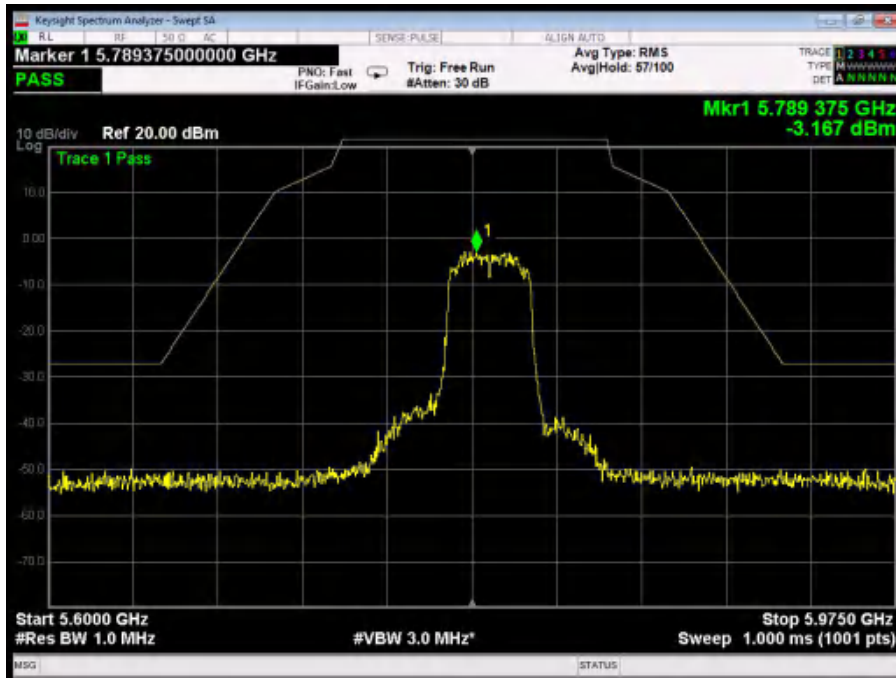

802.11ac(40): Band Edge, Right Side

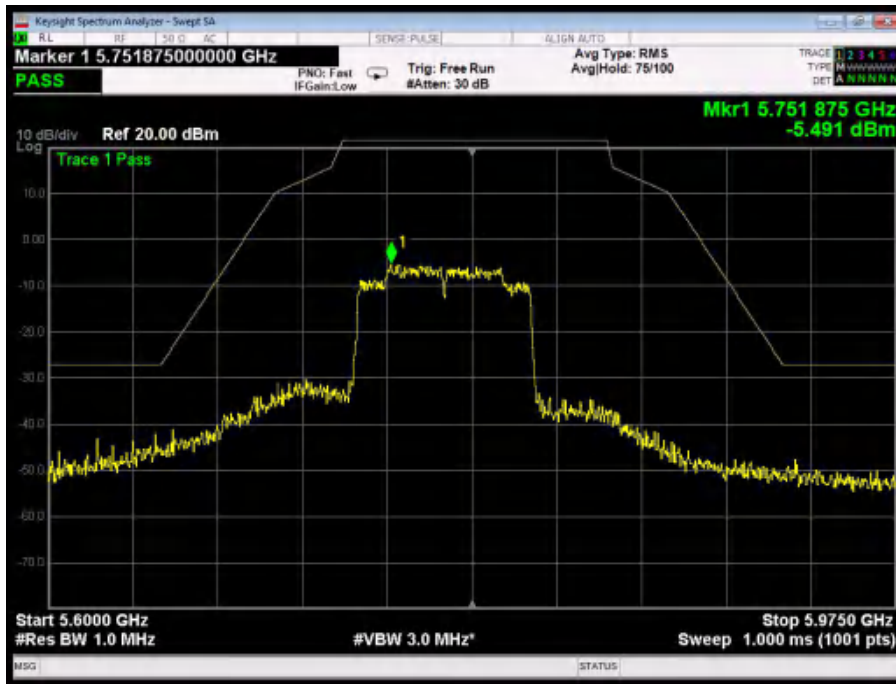

802.11ac(80): Band Edge



Test Results (Above 1000MHz)

ANT A+B

Test mode:	IEEE 802.11ac20	Test channel:	Low CH
------------	-----------------	---------------	--------

Peak value:

Frequency (MHz)	Read Level (dBuV)	Antenna Factor (dB/m)	Cable Loss (dB)	Preamp Factor (dB)	Level (dBuV/m)	Limit Line (dBuV/m)	Over Limit (dB)	Pol.
11490.00	42.18	31.98	17.08	33.91	57.33	68.20	-10.87	V
17235.00	41.75	32.65	20.03	34.85	59.58	68.20	-8.62	V
11490.00	42.18	31.98	17.08	33.91	57.33	68.20	-10.87	H
17235.00	41.49	32.65	20.03	34.85	59.32	68.20	-8.88	H

Average value:

Frequency (MHz)	Read Level (dBuV)	Antenna Factor (dB/m)	Cable Loss (dB)	Preamp Factor (dB)	Level (dBuV/m)	Limit Line (dBuV/m)	Over Limit (dB)	Pol.
11490.00	29.10	31.98	17.08	33.91	44.25	54.00	-9.75	V
17235.00	29.36	32.65	20.03	34.85	47.19	54.00	-6.81	V
11490.00	30.65	31.98	17.08	33.91	45.80	54.00	-8.20	H
17235.00	29.40	32.65	20.03	34.85	47.23	54.00	-6.77	H

Test mode:	IEEE 802.11ac20	Test channel:	Mid CH
------------	-----------------	---------------	--------

Peak value:

Frequency (MHz)	Read Level (dBuV)	Antenna Factor (dB/m)	Cable Loss (dB)	Preamp Factor (dB)	Level (dBuV/m)	Limit Line (dBuV/m)	Over Limit (dB)	Pol.
11570.00	40.45	32.44	17.18	33.91	56.16	68.20	-12.04	V
17355.00	42.91	32.78	20.12	34.86	60.95	68.20	-7.25	V
11570.00	40.78	32.44	17.18	33.91	56.49	68.20	-11.71	H
17355.00	42.72	32.78	20.12	34.86	60.76	68.20	-7.44	H



Average value:

Frequency (MHz)	Read Level (dBuV)	Antenna Factor (dB/m)	Cable Loss (dB)	Preamp Factor (dB)	Level (dBuV/m)	Limit Line (dBuV/m)	Over Limit (dB)	Pol.
11570.00	30.34	32.44	17.18	33.91	46.05	54.00	-7.95	V
17355.00	29.15	32.78	20.12	34.86	47.19	54.00	-6.81	V
11570.00	30.06	32.44	17.18	33.91	45.77	54.00	-8.23	H
17355.00	29.77	32.78	20.12	34.86	47.81	54.00	-6.19	H

Test mode:	IEEE 802.11ac20	Test channel:	High CH
------------	-----------------	---------------	---------

Peak value:

Frequency (MHz)	Read Level (dBuV)	Antenna Factor (dB/m)	Cable Loss (dB)	Preamp Factor (dB)	Level (dBuV/m)	Limit Line (dBuV/m)	Over Limit (dB)	Pol.
11650.00	42.83	32.59	18.02	33.92	59.52	68.20	-8.68	V
17475.00	40.96	32.87	20.15	34.88	59.10	68.20	-9.10	V
11650.00	42.96	32.59	18.02	33.92	59.65	68.20	-8.55	H
17475.00	40.72	32.87	20.15	34.88	58.86	68.20	-9.34	H

Average value:

Frequency (MHz)	Read Level (dBuV)	Antenna Factor (dB/m)	Cable Loss (dB)	Preamp Factor (dB)	Level (dBuV/m)	Limit Line (dBuV/m)	Over Limit (dB)	Pol.
11650.00	30.24	32.59	18.02	33.92	46.93	54.00	-7.07	V
17475.00	29.93	32.87	20.15	34.88	48.07	54.00	-5.93	V
11650.00	30.91	32.59	18.02	33.92	47.60	54.00	-6.40	H
17475.00	28.19	32.87	20.15	34.88	46.33	54.00	-7.67	H

Note:

1. Final Level =Receiver Read level + Antenna Factor + Cable Loss–Preamplifier Factor
2. During the test, pre-scan all modes, and found 802.11ac20 mode is the worst case and only the worst case is recorded in the report.



7 Maximum Peak Output Power Test

7.1 Test Standard and Limit

Test Standard	FCC Part15 C Section 15.407 (a) (3)
Test Limit	30dBm

7.2 Test Setup

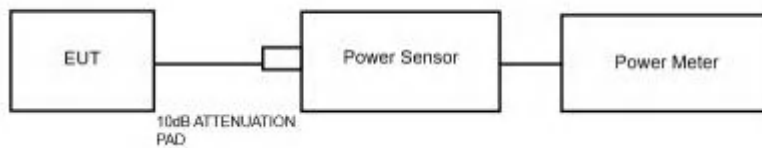

7.3 Test Procedure

1. The Transmitter output (antenna port) was connected to the power meter.
2. Turn on the EUT and power meter and then record the power value.
3. Repeat above procedures on all channels needed to be tested.

Note: The cable loss and attenuator loss were offset into measure device as an amplitude offset.



7.4 Test Data

Test Item	: Max. peak output power	Test Mode	: CH Low ~ CH High
Test Voltage	: DC 24V	Test Result	: PASS

ANT A:

Mode	Channel Frequency (MHz)	Peak Power output (dBm)	Correctional Limit (dBm)	Results
802.11a	5745	15.34	30	PASS
	5785	15.46	30	PASS
	5825	15.06	30	PASS
802.11n20	5745	16.00	30	PASS
	5785	16.17	30	PASS
	5825	16.02	30	PASS
802.11ac20	5745	16.00	30	PASS
	5785	16.19	30	PASS
	5825	17.00	30	PASS
802.11n40	5755	15.14	30	PASS
	5795	15.78	30	PASS
802.11ac40	5755	15.47	30	PASS
	5795	15.35	30	PASS
802.11ac80	5775	15.33	30	PASS



ANT B:

Mode	Channel Frequency (MHz)	Peak Power output (dBm)	Correctional Limit (dBm)	Results
802.11a	5745	14.09	30	PASS
	5785	13.60	30	PASS
	5825	13.14	30	PASS
802.11n20	5745	13.98	30	PASS
	5785	13.11	30	PASS
	5825	12.18	30	PASS
802.11ac20	5745	13.59	30	PASS
	5785	13.10	30	PASS
	5825	12.51	30	PASS
802.11n40	5755	13.88	30	PASS
	5795	13.71	30	PASS
802.11ac40	5755	13.99	30	PASS
	5795	13.32	30	PASS
802.11ac80	5775	13.80	30	PASS



ANT A+B

Mode	Channel Frequency (MHz)	Peak Power output (dBm)	Correctional Limit (dBm)	Results
802.11n20	5745	17.91	29.99	PASS
	5785	17.79	29.99	PASS
	5825	17.38	29.99	PASS
802.11ac20	5745	18.25	29.99	PASS
	5785	18.05	29.99	PASS
	5825	17.67	29.99	PASS
802.11n40	5755	18.11	29.99	PASS
	5795	18.06	29.99	PASS
802.11ac40	5755	18.45	29.99	PASS
	5795	17.72	29.99	PASS
802.11ac80	5775	18.02	29.99	PASS



8 Occupy Bandwidth Test

8.1 Test Standard

Test Standard	FCC Part15 C Section 15.407 (a)(5)&15.407(e)
---------------	--

8.2 Test Setup

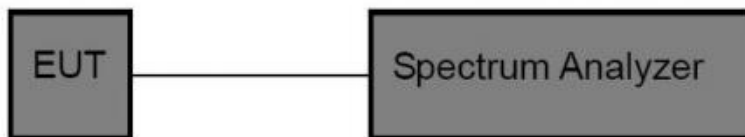

8.3 Test Procedure

1. Place the EUT on the table and set it in the transmitting mode.
2. Remove the antenna from the EUT and then connect a low loss RF cable from the antenna port to the spectrum analyzer.
3. Set the spectrum analyzer as:

26 dB & 99% bandwidth

RBW = approximately 1% of the emission bandwidth;

Set the VBW > RBW;

Detector= Peak

Trace mode= Max hold.

Sweep- auto couple.

6 dB bandwidth

RBW = 100kHz;

Set the video bandwidth (VBW) \geq 3 RBW;

Detector= Peak

Trace mode= Max hold.

Sweep- auto couple.



4. Measure the maximum width of the emission that is 26dB /6dB down from the maximum of the emission. Compare this with the RBW setting of the analyzer
5. Repeat until all the rest channels are investigated.

8.4 Test Data

Test Item	: 6dB &26dB BW	Test Mode	: CH Low ~ CH High
Test Voltage	: DC 24V	Test Result	: PASS

ANT A:

Mode	Channel Frequency (MHz)	6dB BW(MHz)	Limit	Results
802.11a	5745	16.32	>0.5MHz	PASS
	5785	16.37		PASS
	5825	16.35		PASS
802.11n20	5745	17.32		PASS
	5785	17.30		PASS
	5825	16.91		PASS
802.11ac20	5745	16.92		PASS
	5785	17.58		PASS
	5825	17.55		PASS
802.11n40	5755	35.49		PASS
	5795	35.45		PASS
802.11ac40	5755	35.91		PASS
	5795	35.71		PASS
802.11ac80	5775	75.46		PASS



Mode	Channel Frequency (MHz)	26dB BW(MHz)	99% Bandwidth (MHz)
802.11a	5745	21.09	16.652
	5785	21.17	16.661
	5825	21.27	16.690
802.11n20	5745	21.57	17.871
	5785	21.55	17.855
	5825	21.60	17.797
802.11ac20	5745	21.50	17.770
	5785	21.40	17.815
	5825	21.61	17.903
802.11n40	5755	39.80	36.265
	5795	39.49	36.268
802.11ac40	5755	39.78	36.231
	5795	39.76	36.267
802.11ac80	5775	80.90	75.432



6dB Bandwidth

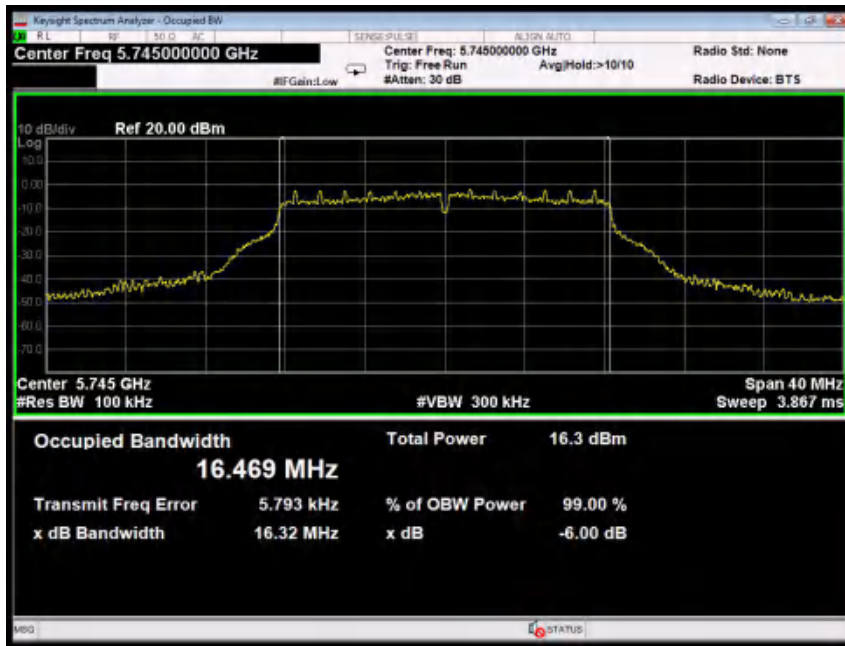

Test Mode: 802.11a--Low

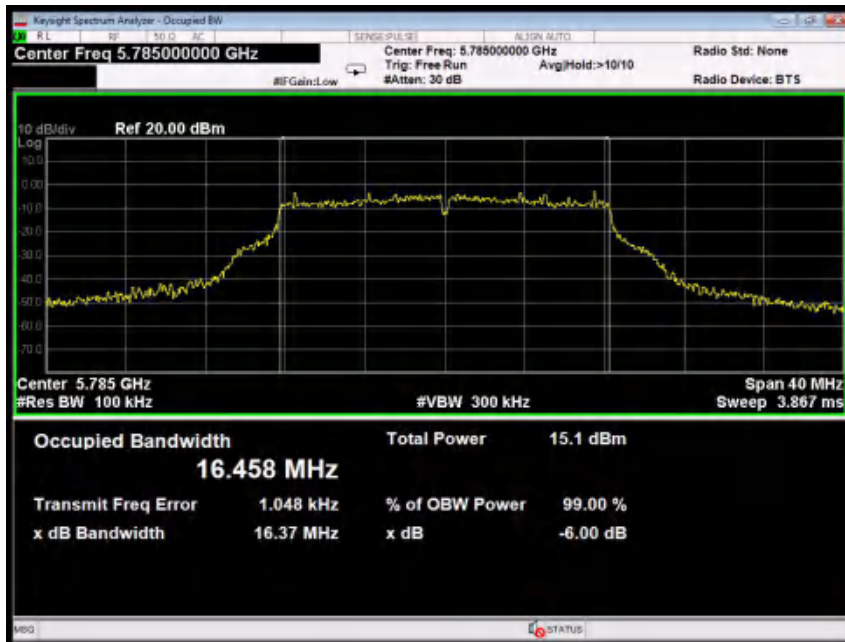

Test Mode: 802.11a---Middle

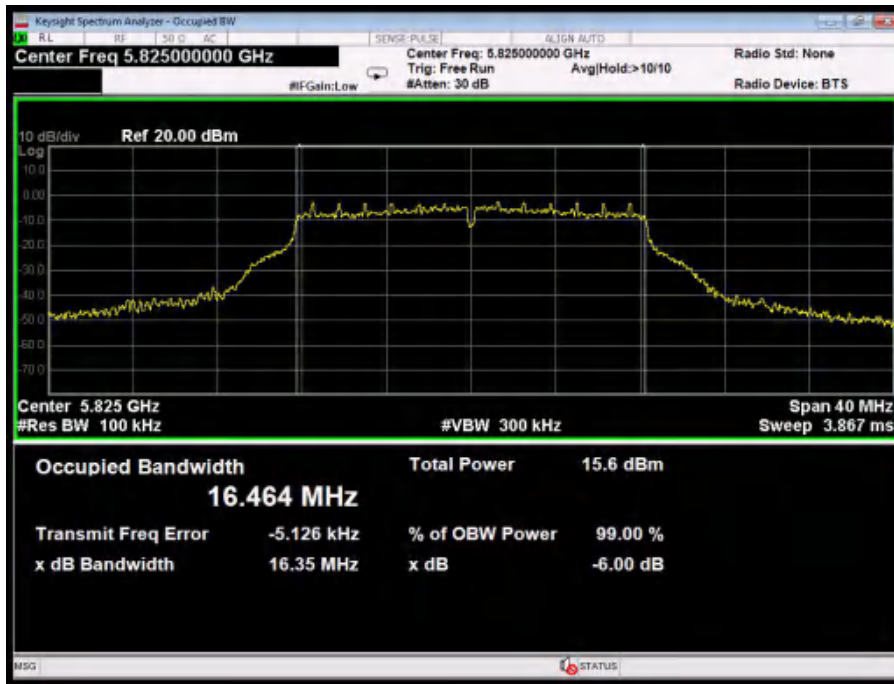

Test Mode: 802.11a---High

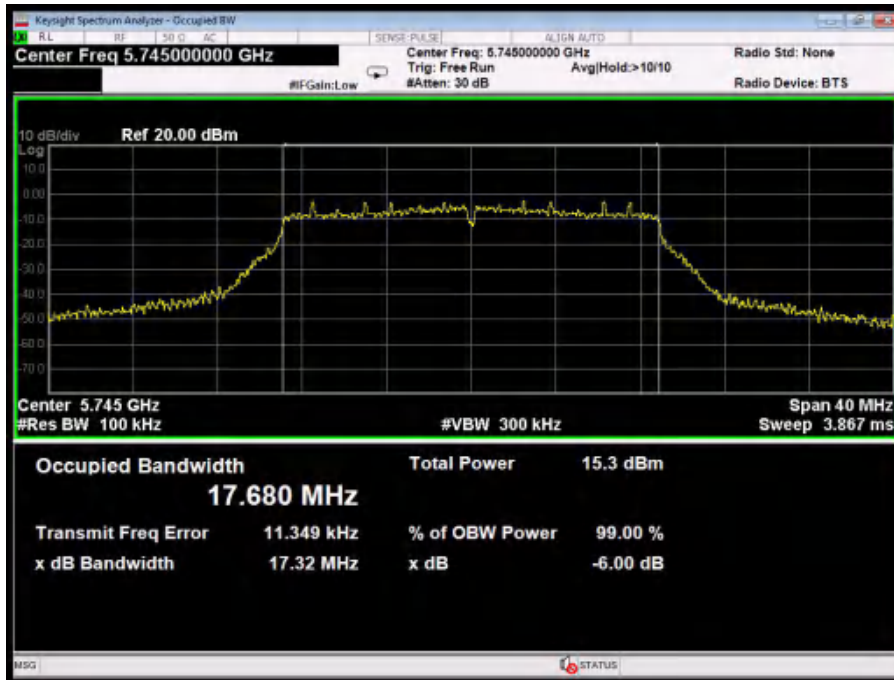

Test Mode: 802.11n20---Low

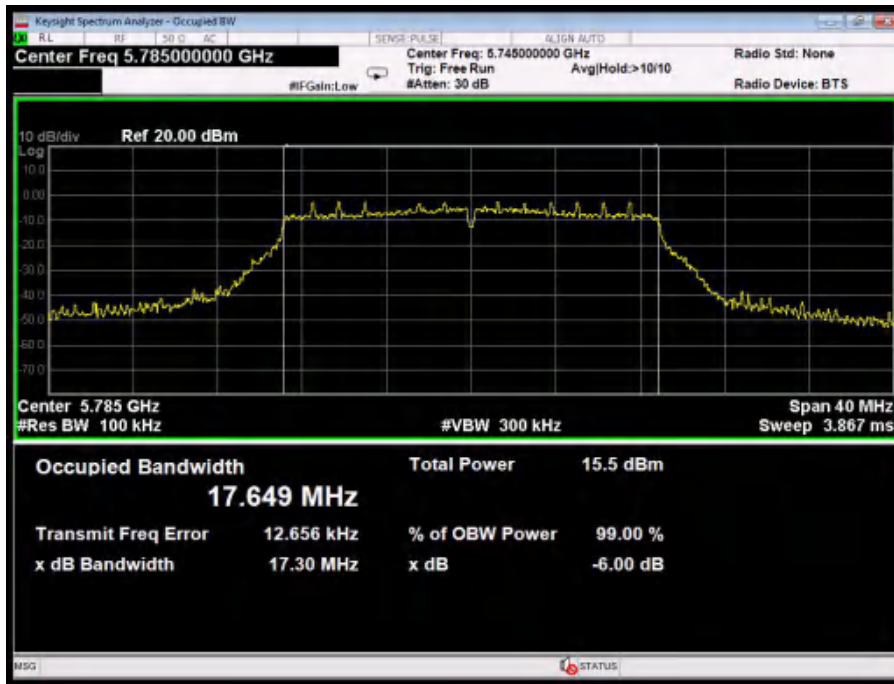

Test Mode: 802.11n20---Middle

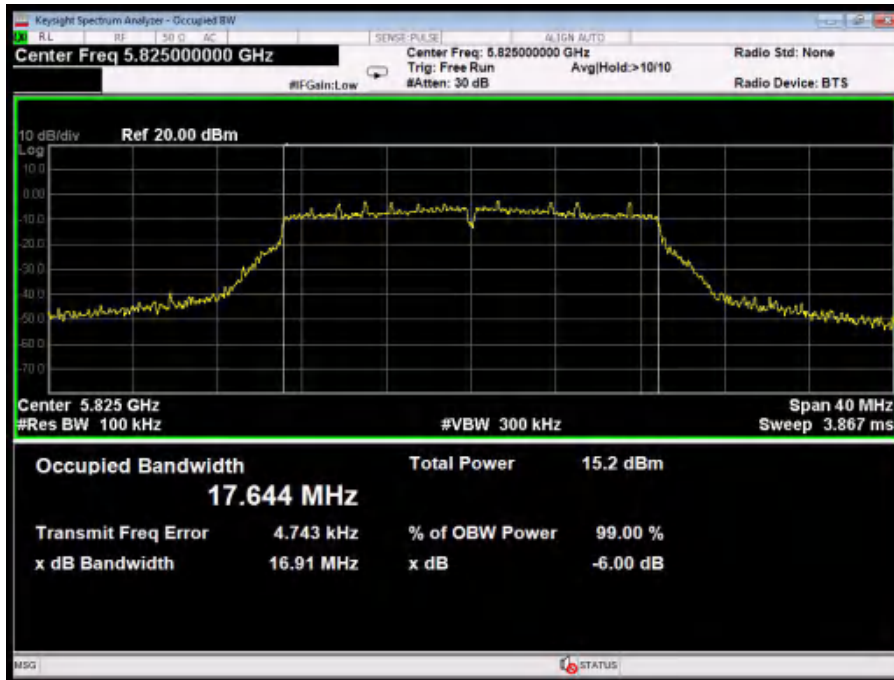

Test Mode: 802.11n20---High

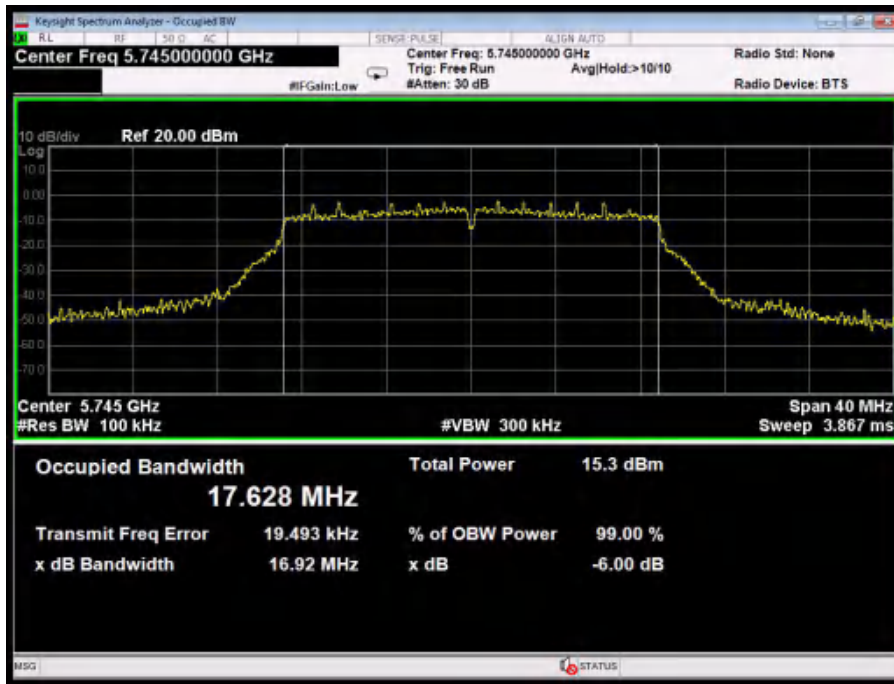

Test Mode: 802.11ac20--Low

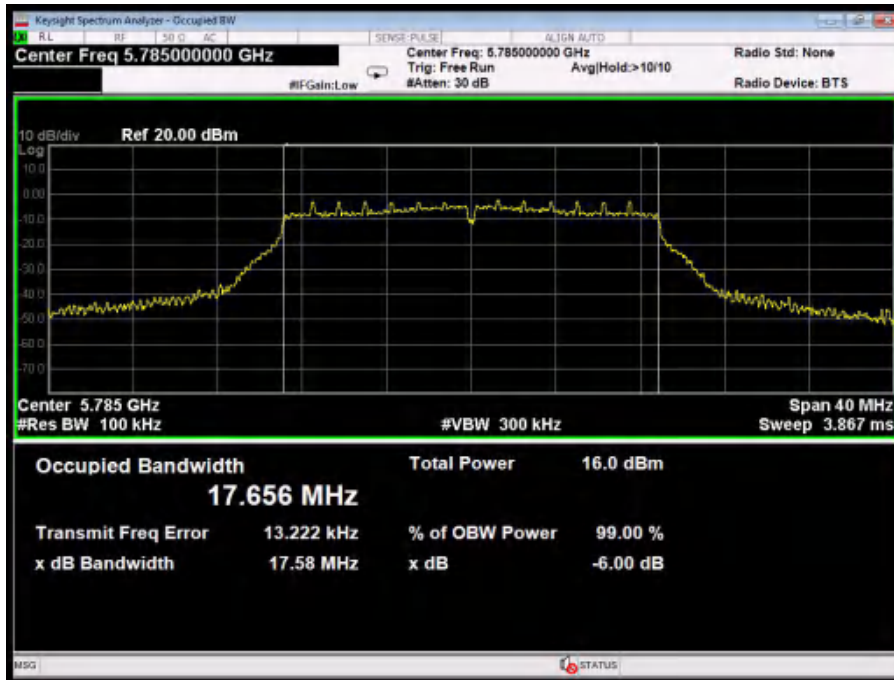

Test Mode: 802.11ac20---Middle

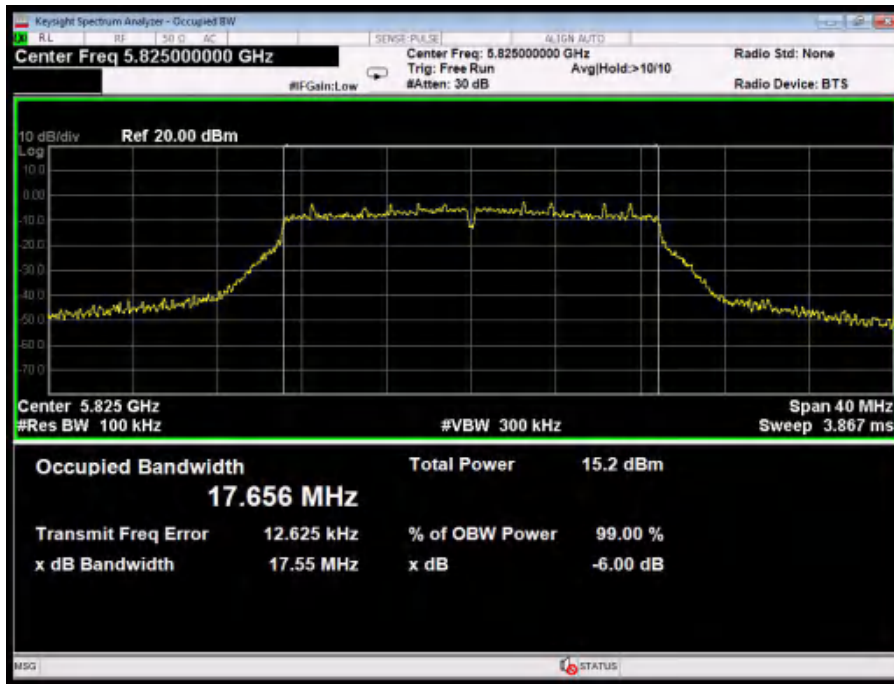

Test Mode: 802.11ac20---High

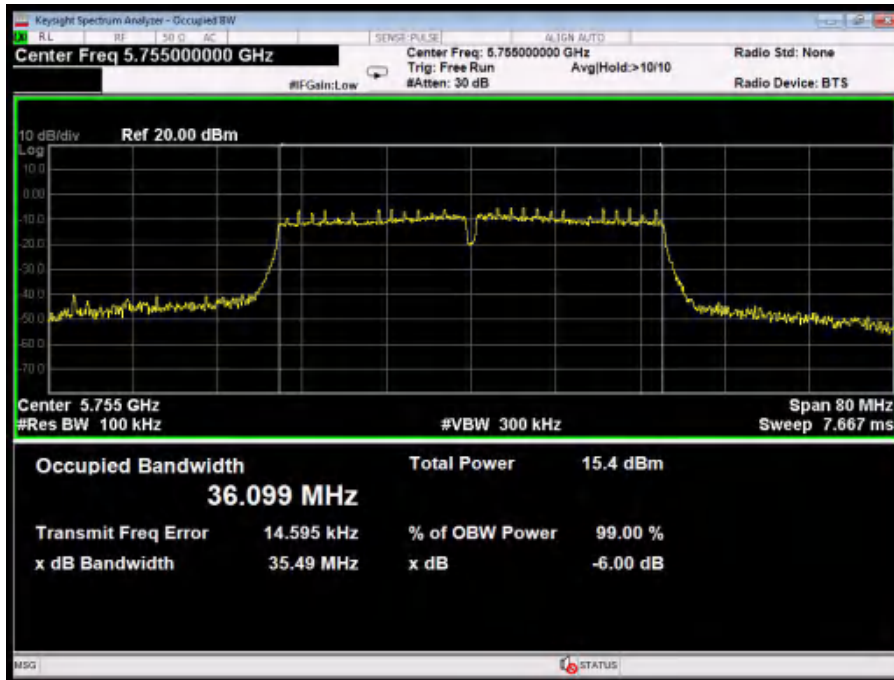

Test Mode: 802.11n40---Low

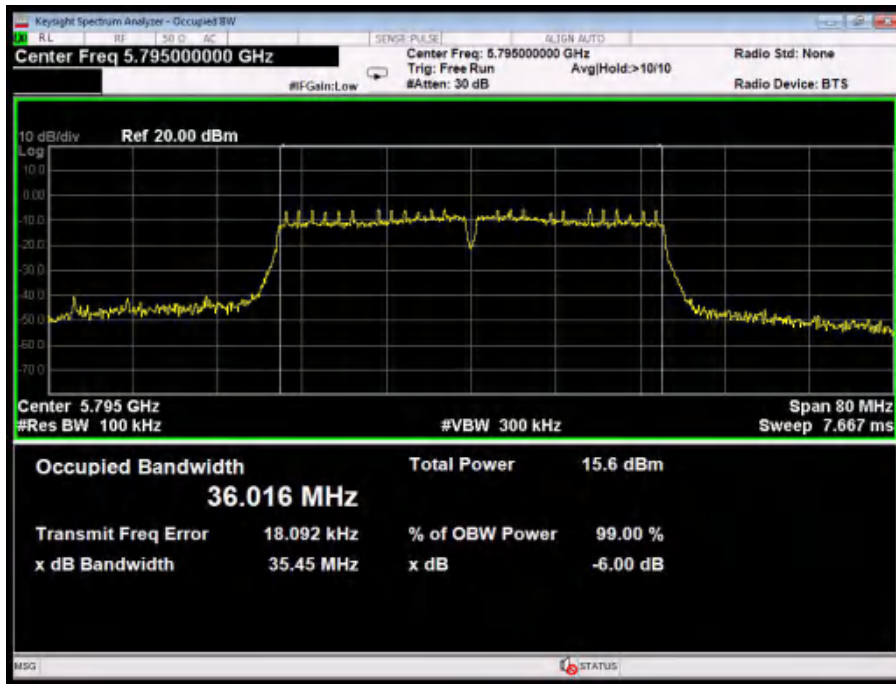

Test Mode: 802.11n40---High

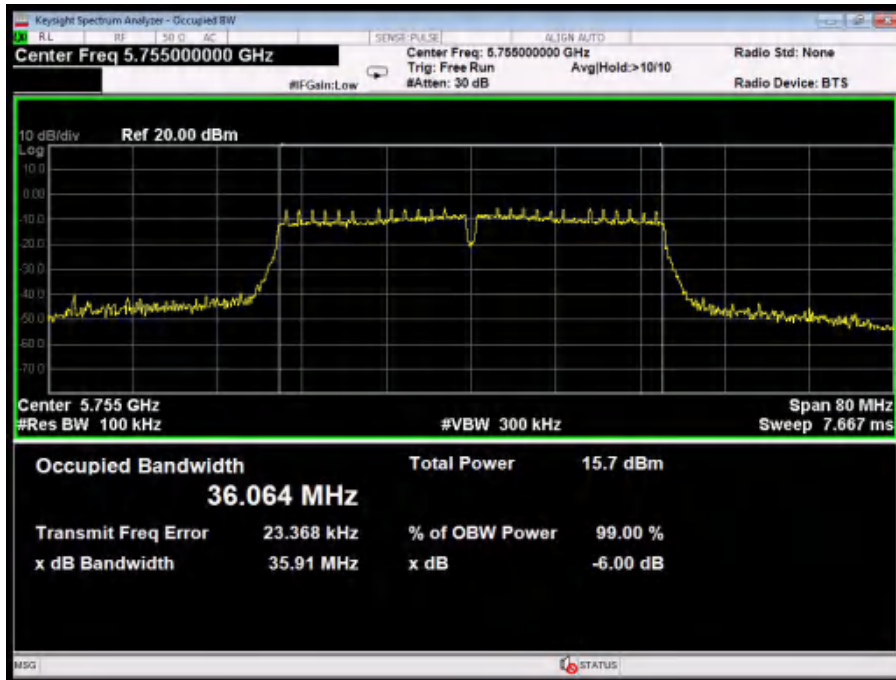

Test Mode: 802.11ac40---Low

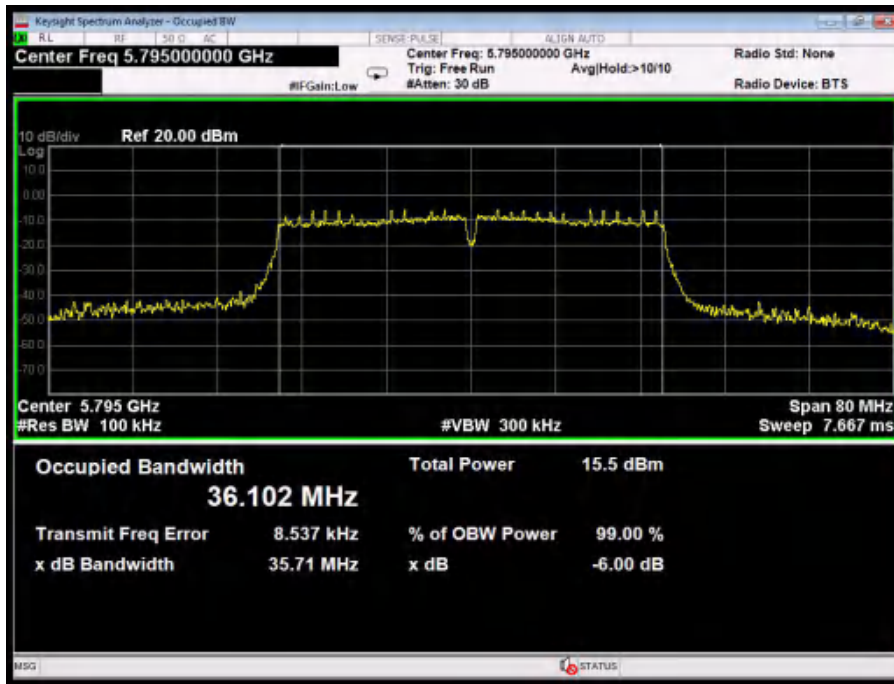

Test Mode: 802.11ac40---High

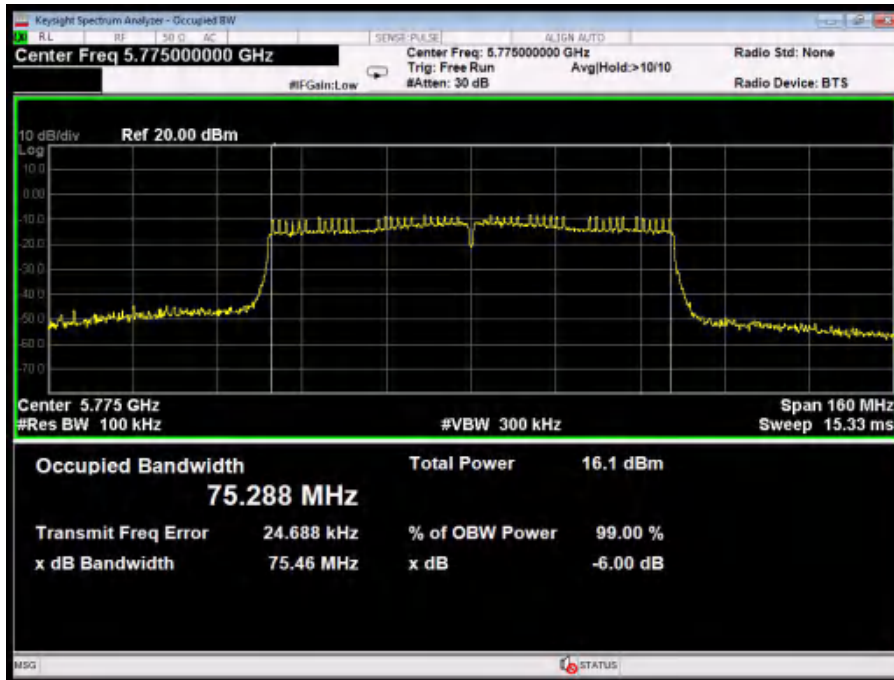

Test Mode: 802.11ac80



26dB & 99% Bandwidth

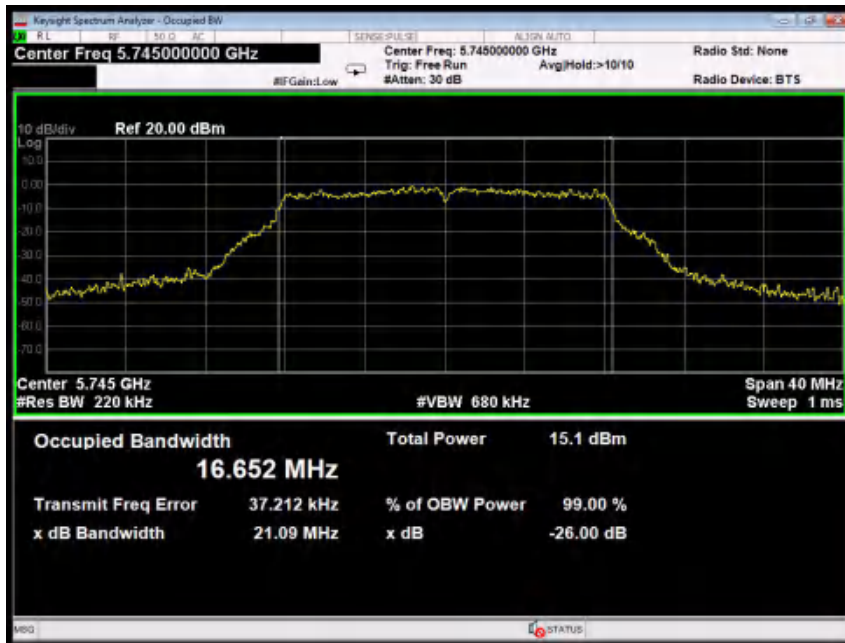

Test Mode: 802.11a--Low

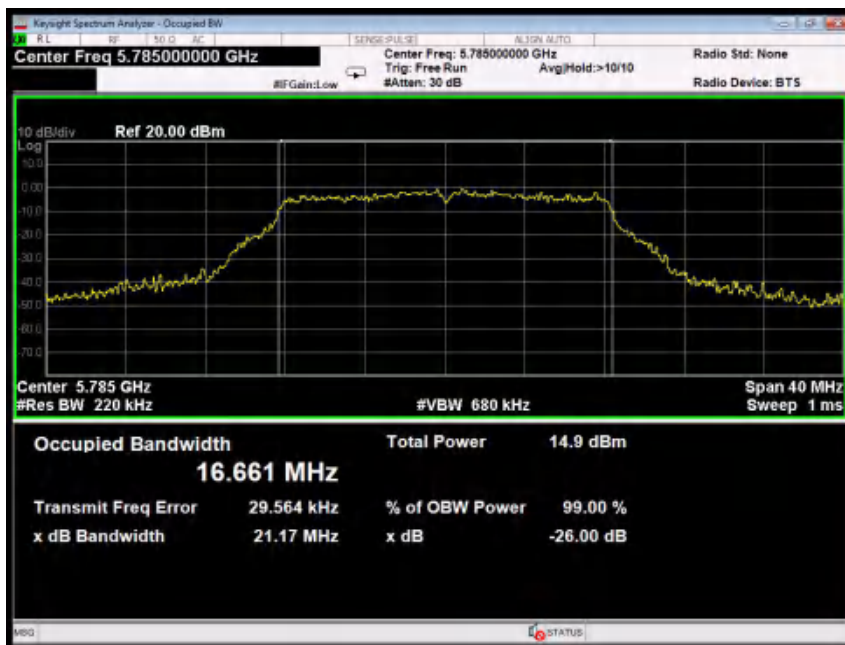

Test Mode: 802.11a---Middle

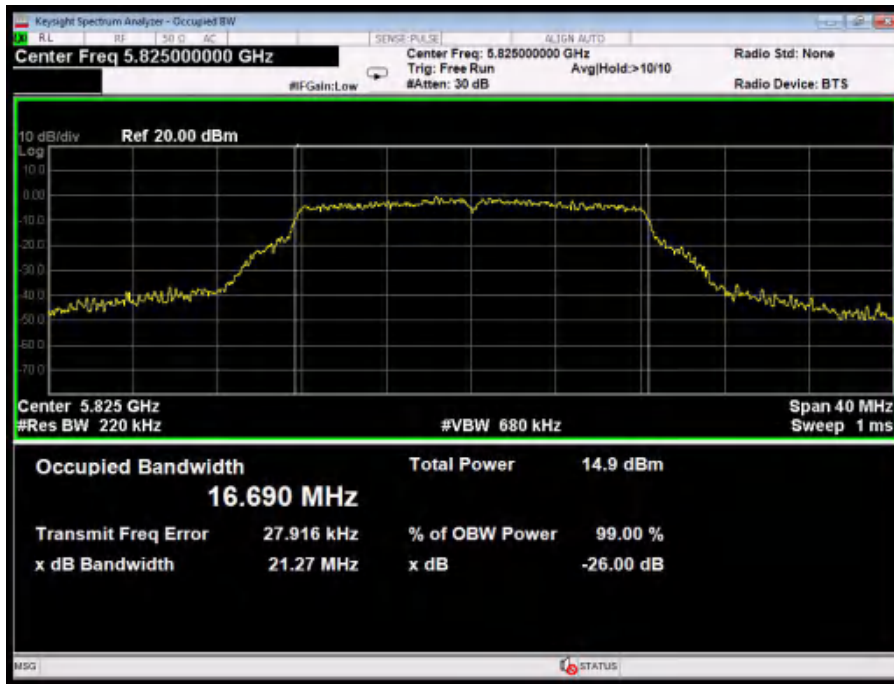

Test Mode: 802.11a---High

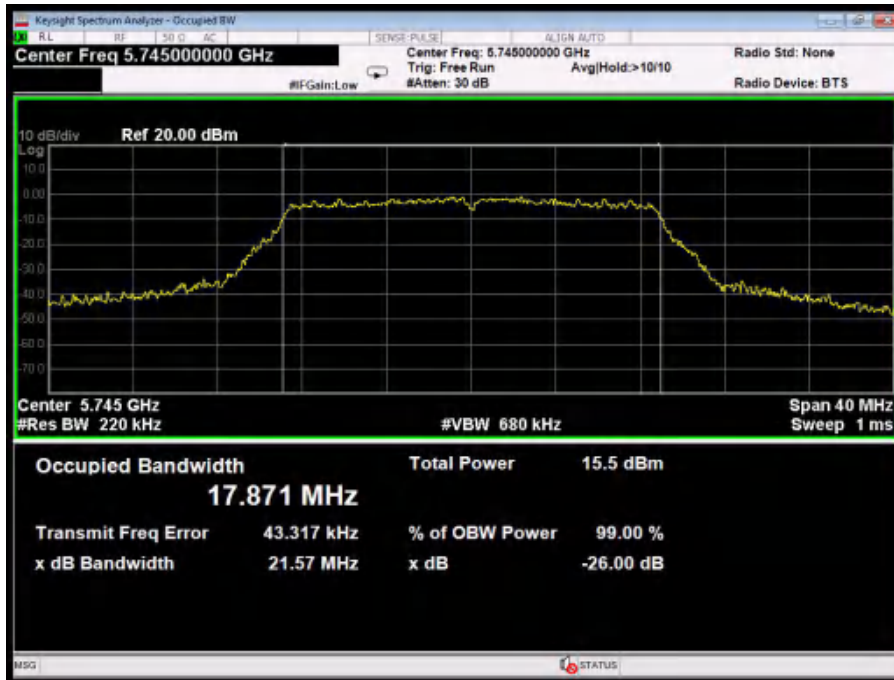

Test Mode: 802.11n20---Low

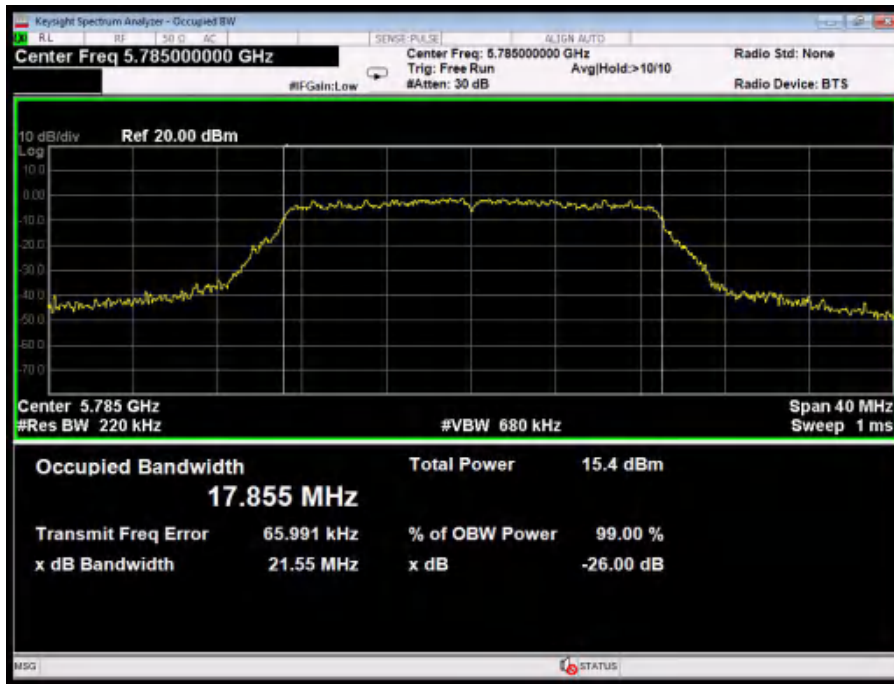

Test Mode: 802.11n20---Middle

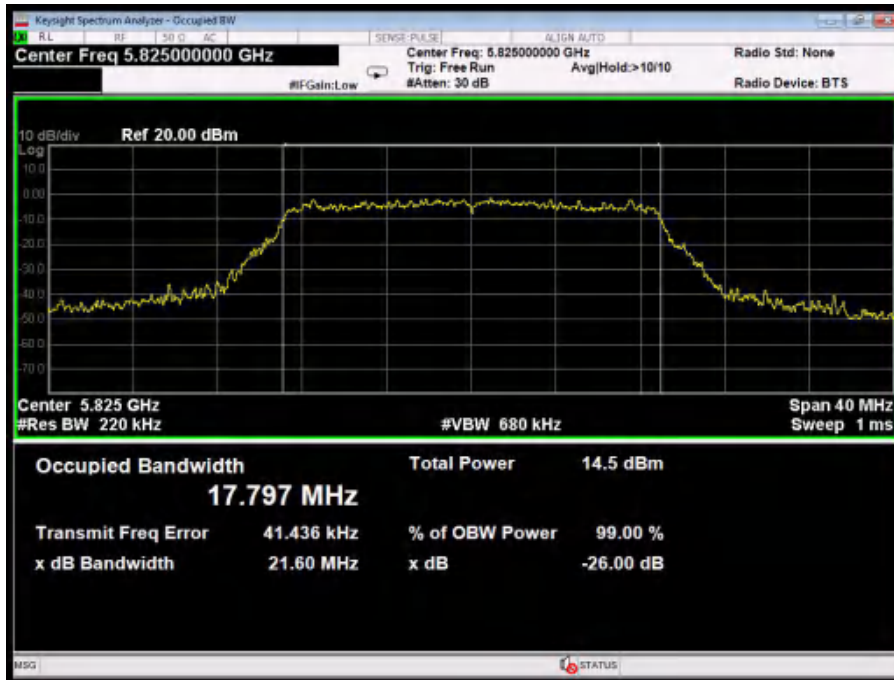

Test Mode: 802.11n20---High

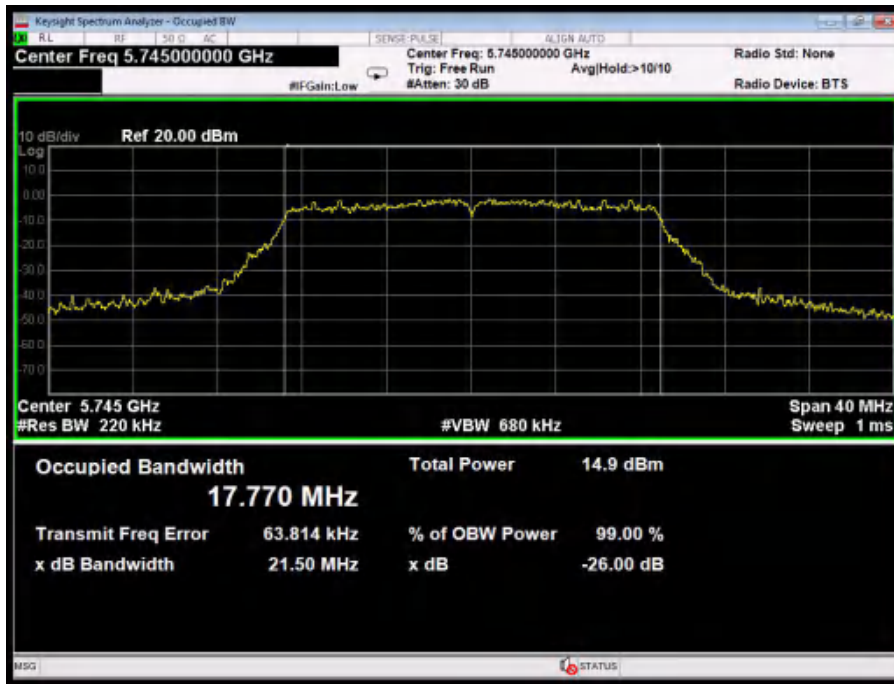

Test Mode: 802.11ac20--Low

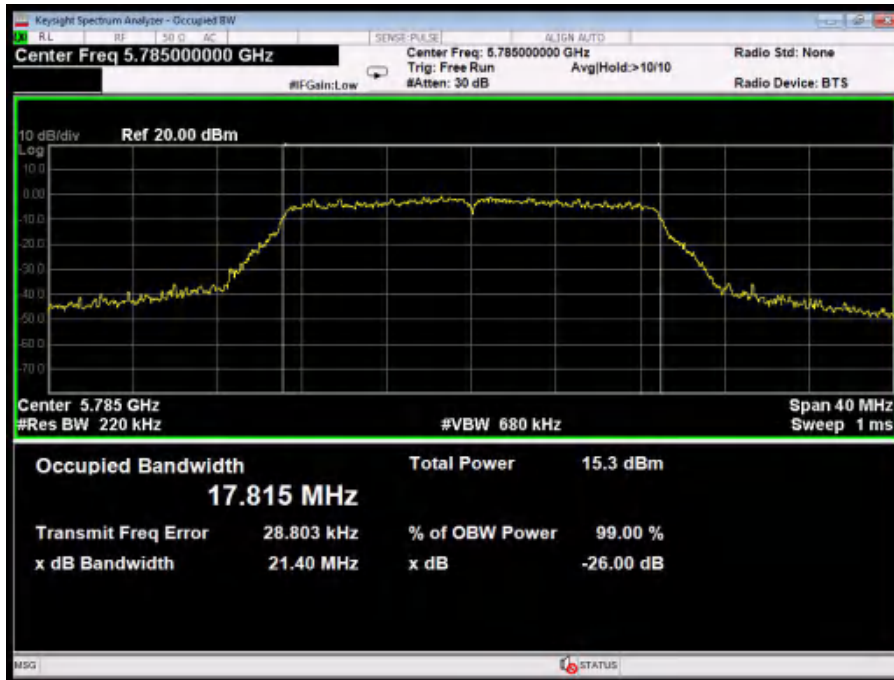

Test Mode: 802.11ac20---Middle

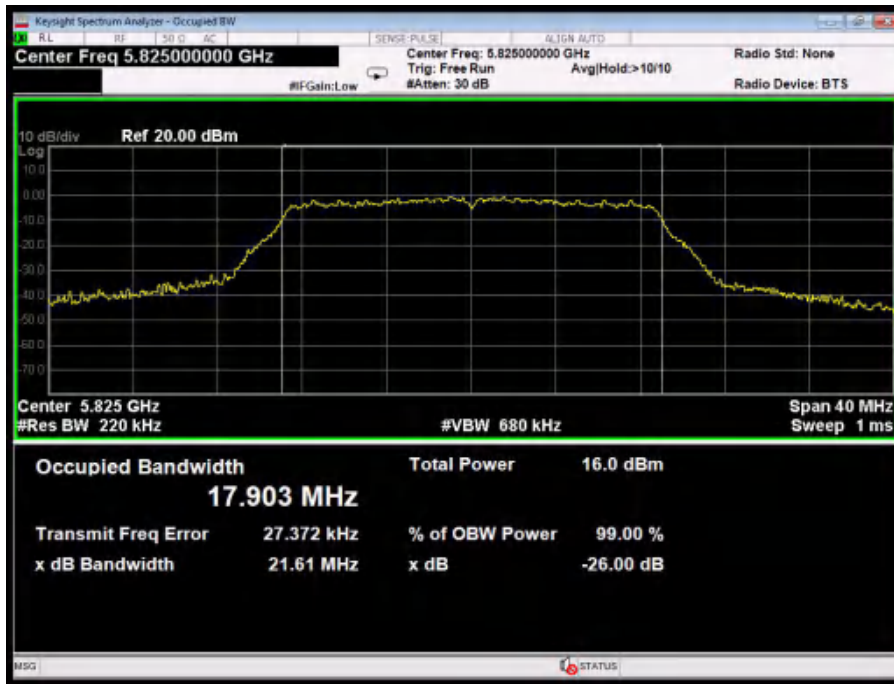

Test Mode: 802.11ac20---High

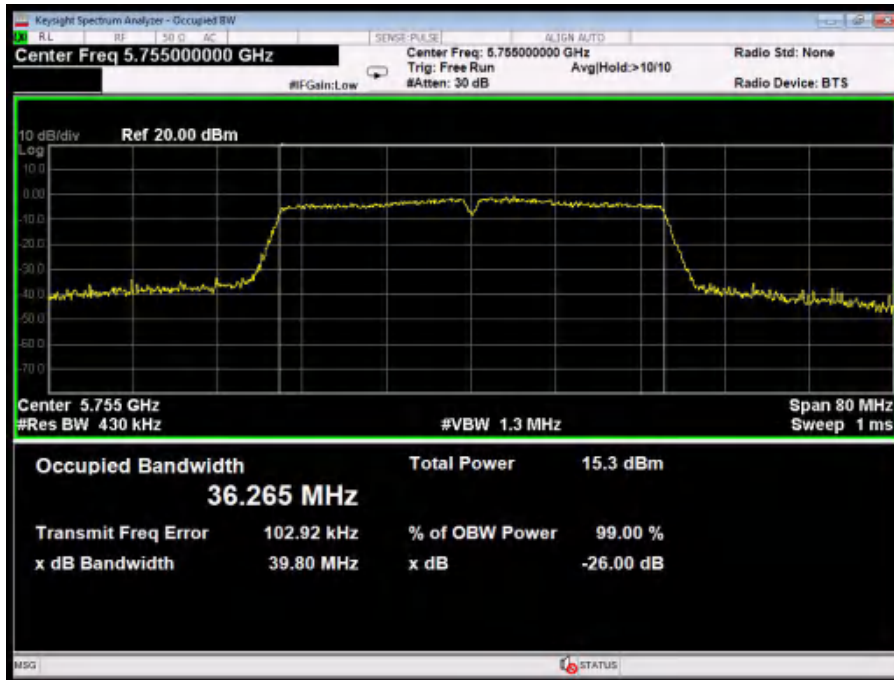

Test Mode: 802.11n40---Low

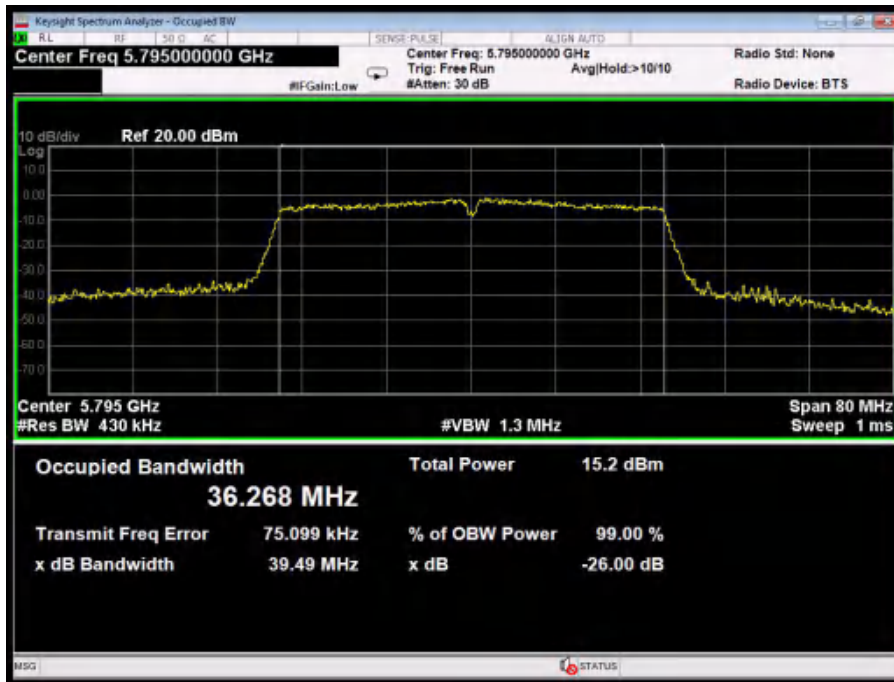

Test Mode: 802.11n40---High

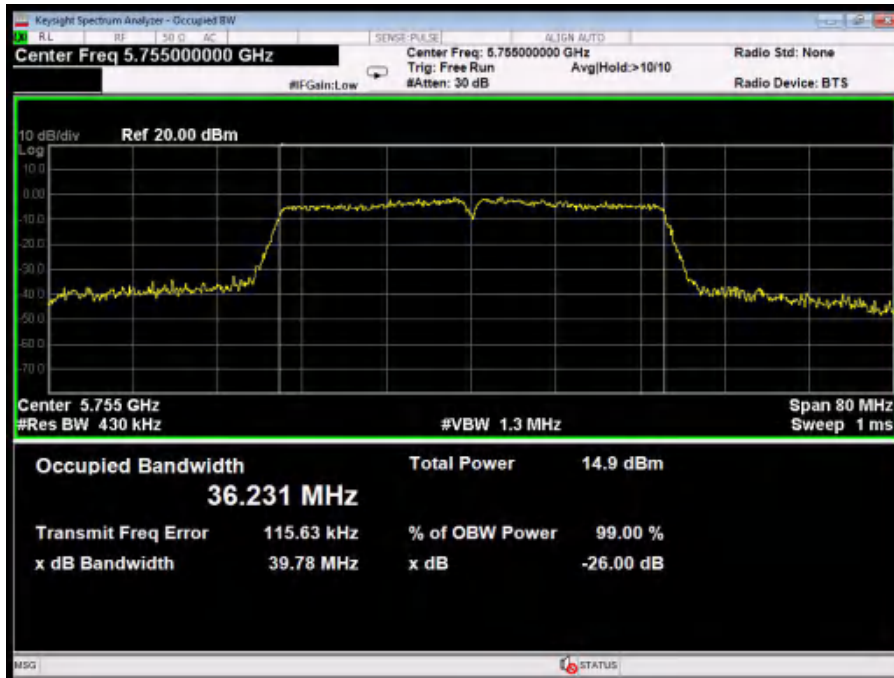

Test Mode: 802.11ac40---Low

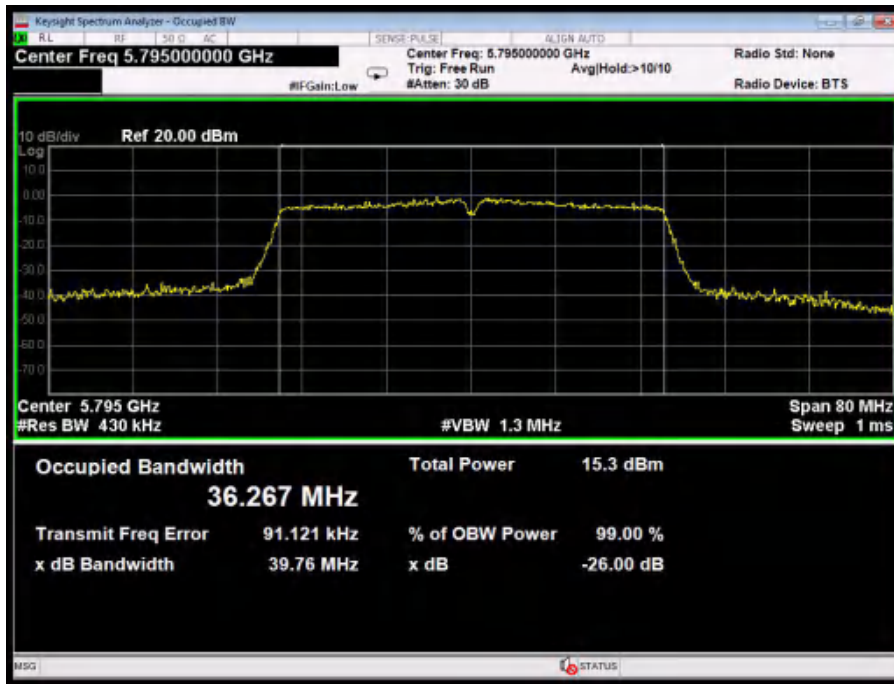

Test Mode: 802.11ac40---High

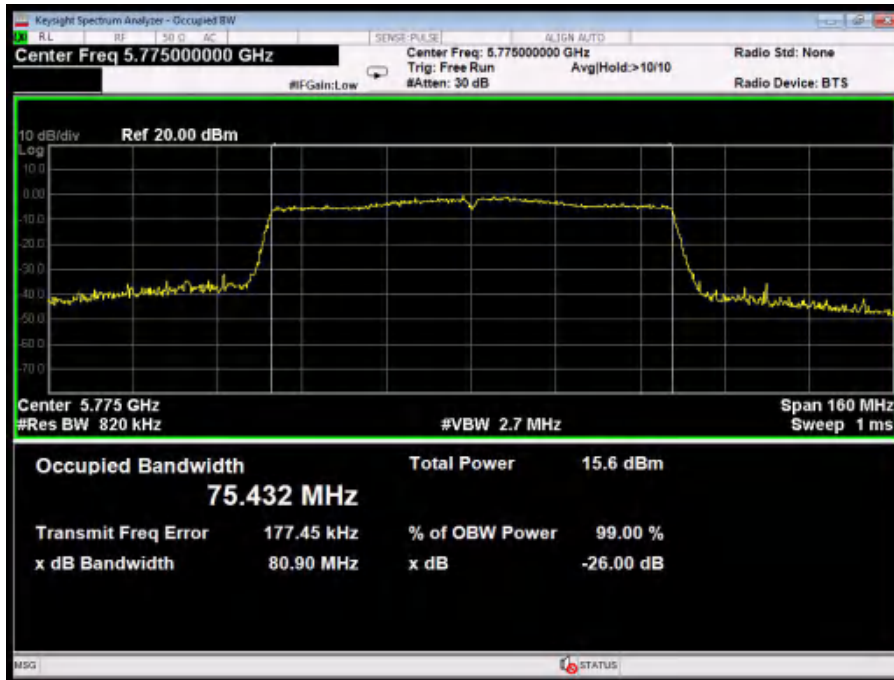

Test Mode: 802.11ac80



ANT B:

Mode	Channel Frequency (MHz)	6dB BW(MHz)	Limit	Results
802.11a	5745	15.17	>0.5MHz	PASS
	5785	14.42		PASS
	5825	14.09		PASS
802.11n20	5745	13.46		PASS
	5785	11.52		PASS
	5825	15.13		PASS
802.11ac20	5745	15.17		PASS
	5785	15.66		PASS
	5825	12.99		PASS
802.11n40	5755	32.62		PASS
	5795	35.18		PASS
802.11ac40	5755	32.57		PASS
	5795	31.45		PASS
802.11ac80	5775	75.34		PASS

Mode	Channel Frequency (MHz)	26dB BW(MHz)	99% Bandwidth (MHz)
802.11a	5745	22.53	16.479
	5785	21.92	16.473
	5825	22.35	16.509
802.11n20	5745	22.81	17.657
	5785	22.45	17.608
	5825	22.84	17.659
802.11ac20	5745	22.39	17.675



	5785	22.01	17.689
	5825	22.49	17.683
802.11n40	5755	41.06	36.087
	5795	41.27	36.112
802.11ac40	5755	42.07	36.057
	5795	41.16	36.067
802.11ac80	5775	80.84	75.378

6dB Bandwidth

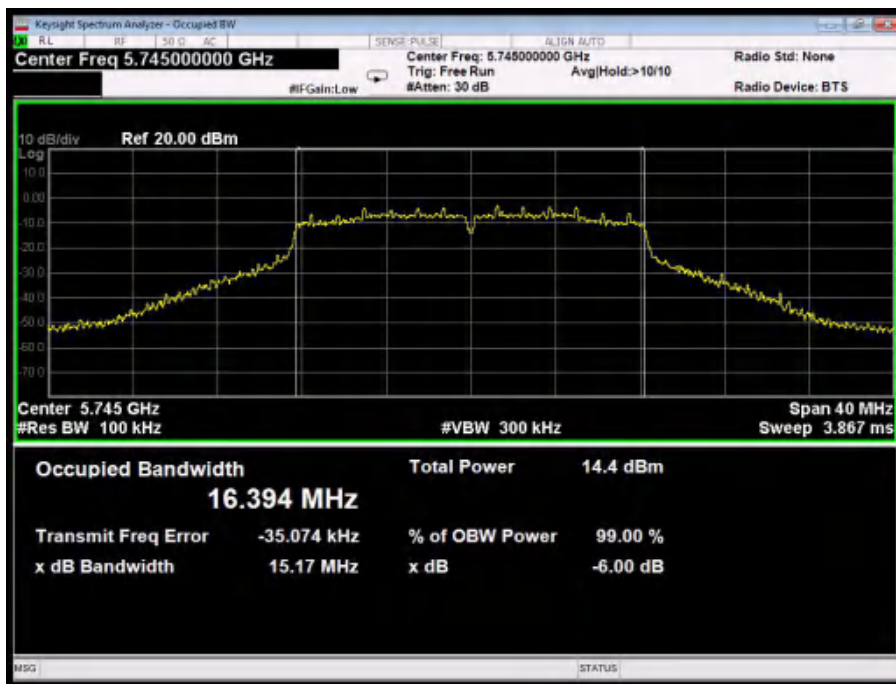

Test Mode: 802.11a--Low

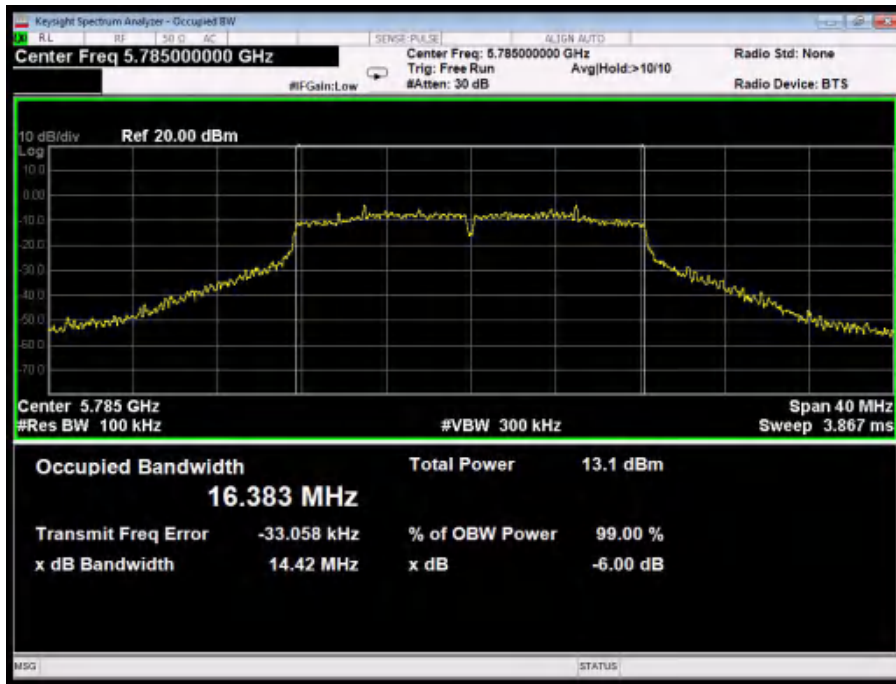

Test Mode: 802.11a---Middle

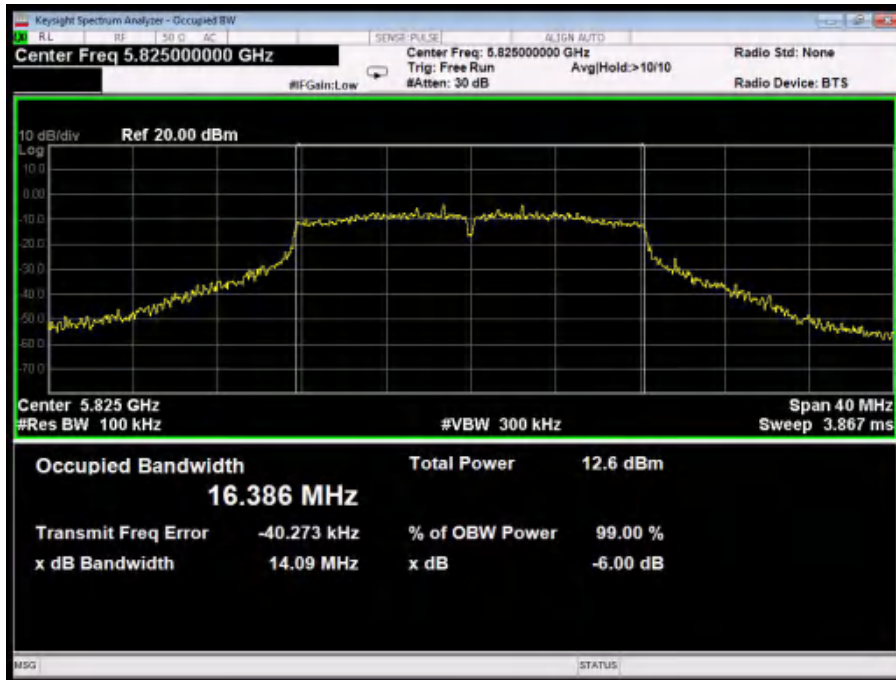

Test Mode: 802.11a---High

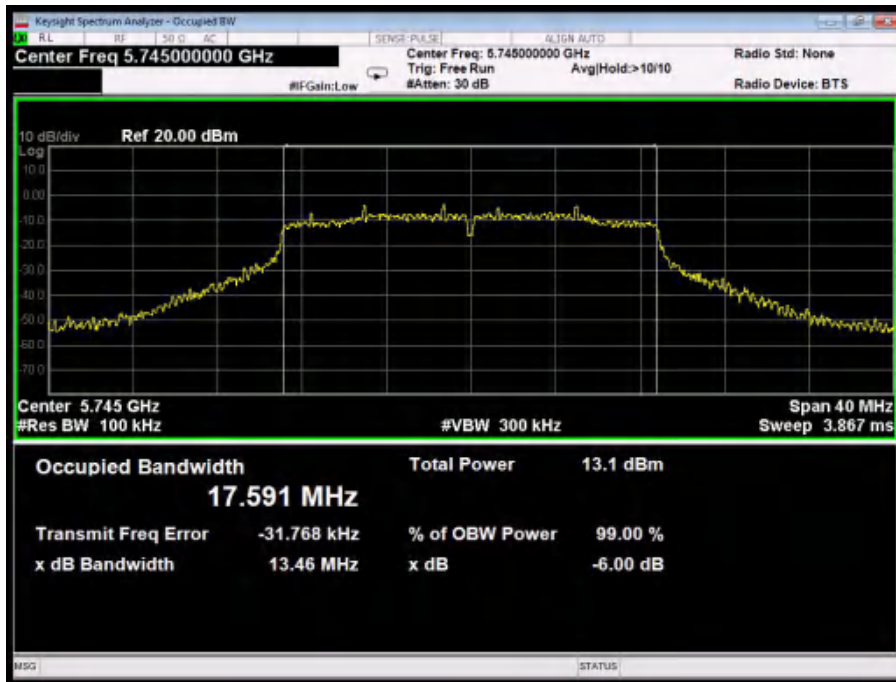

Test Mode: 802.11n20---Low

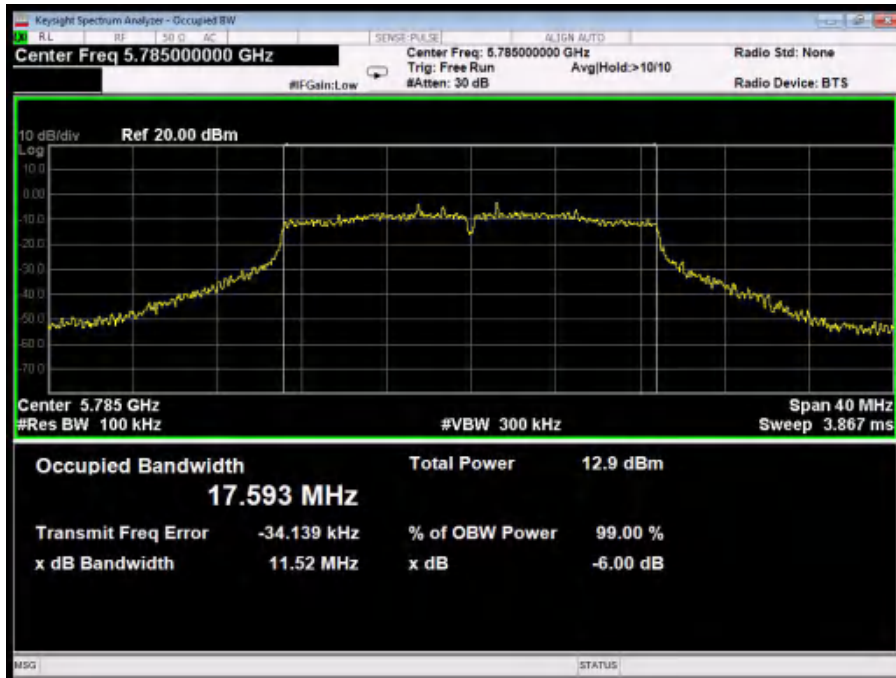

Test Mode: 802.11n20---Middle

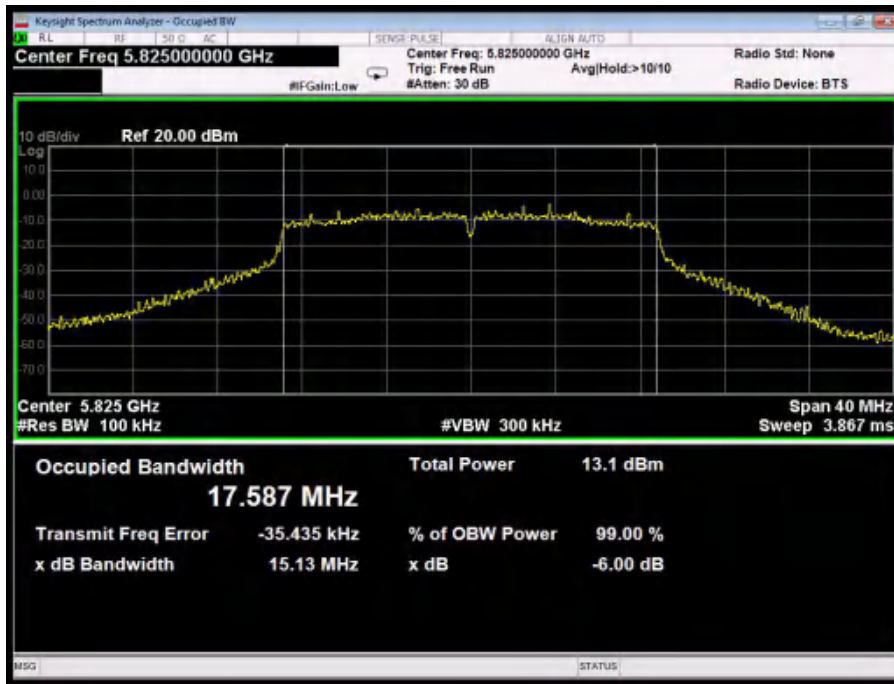

Test Mode: 802.11n20---High

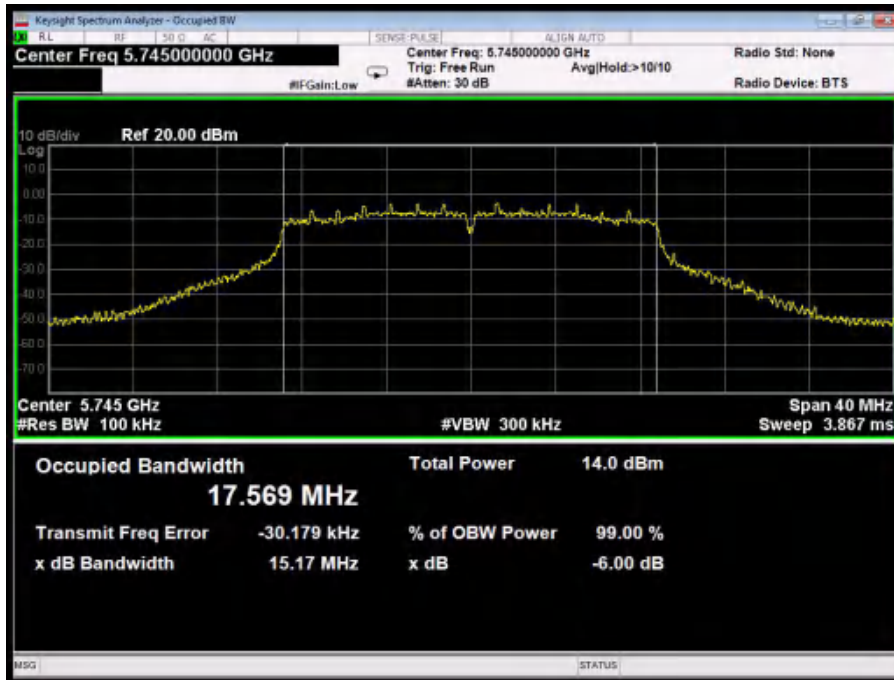

Test Mode: 802.11ac20--Low

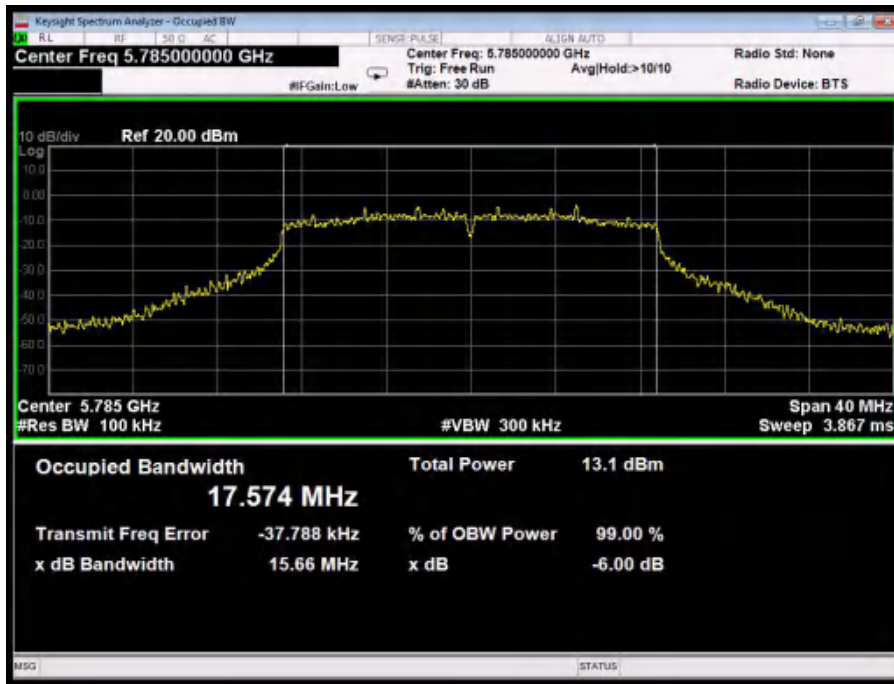

Test Mode: 802.11ac20---Middle

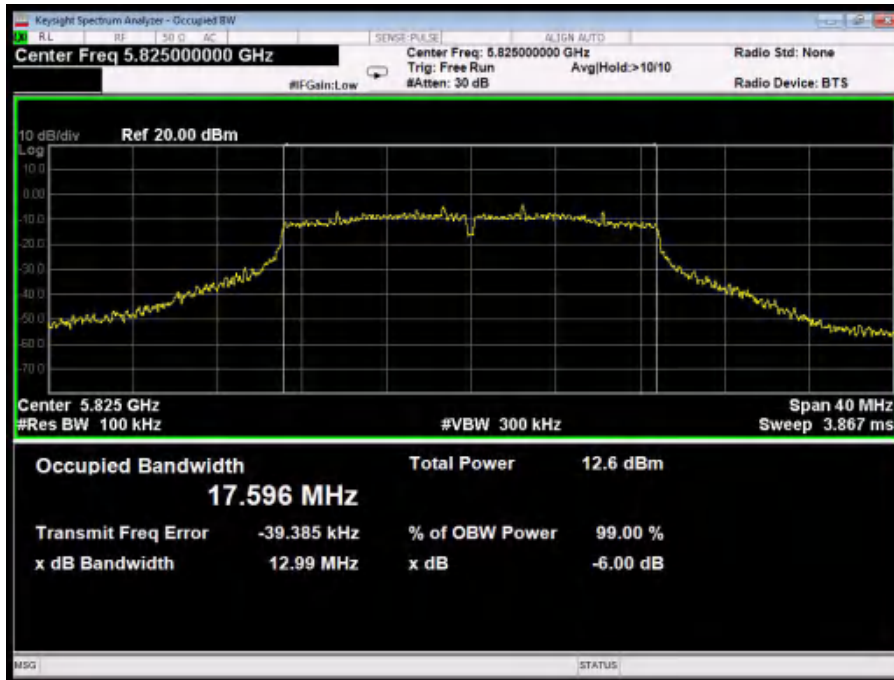

Test Mode: 802.11ac20---High

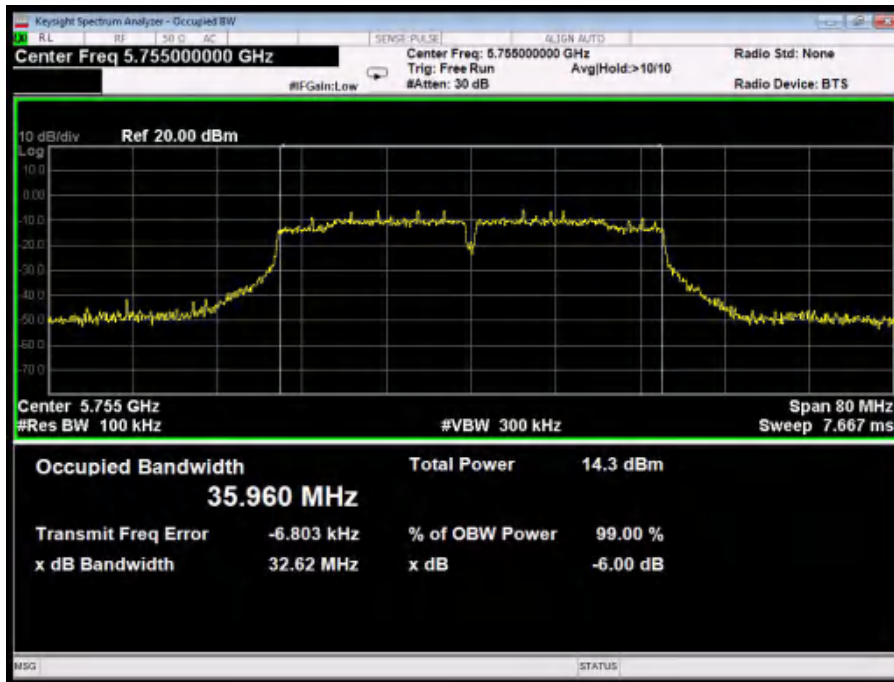

Test Mode: 802.11n40---Low

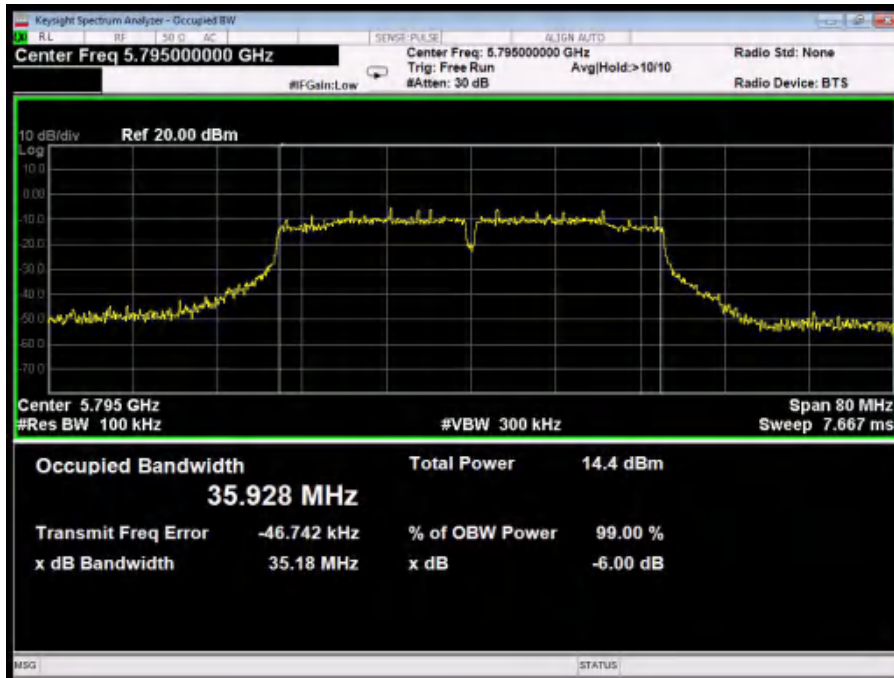

Test Mode: 802.11n40---High

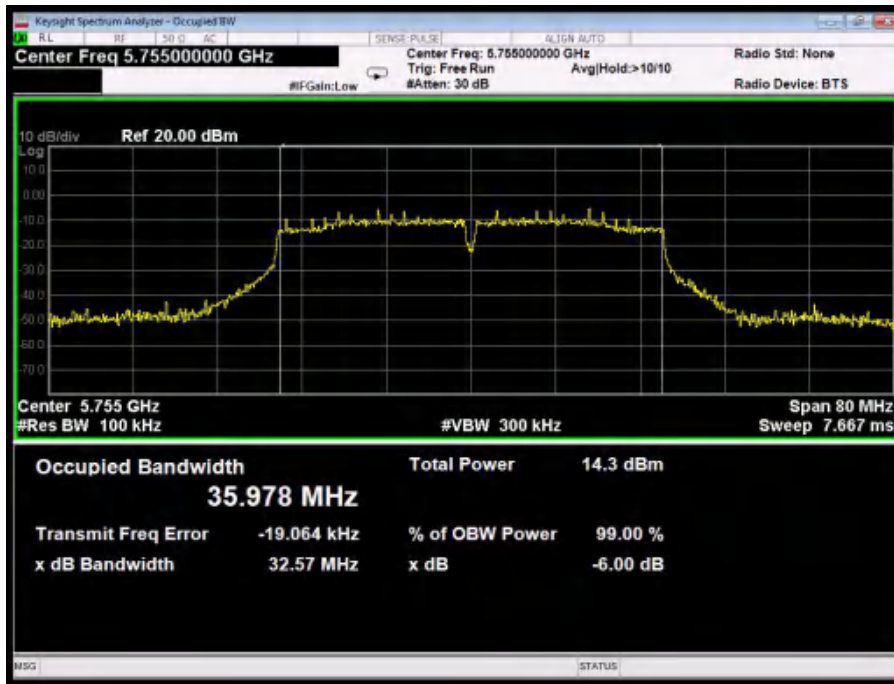

Test Mode: 802.11ac40---Low

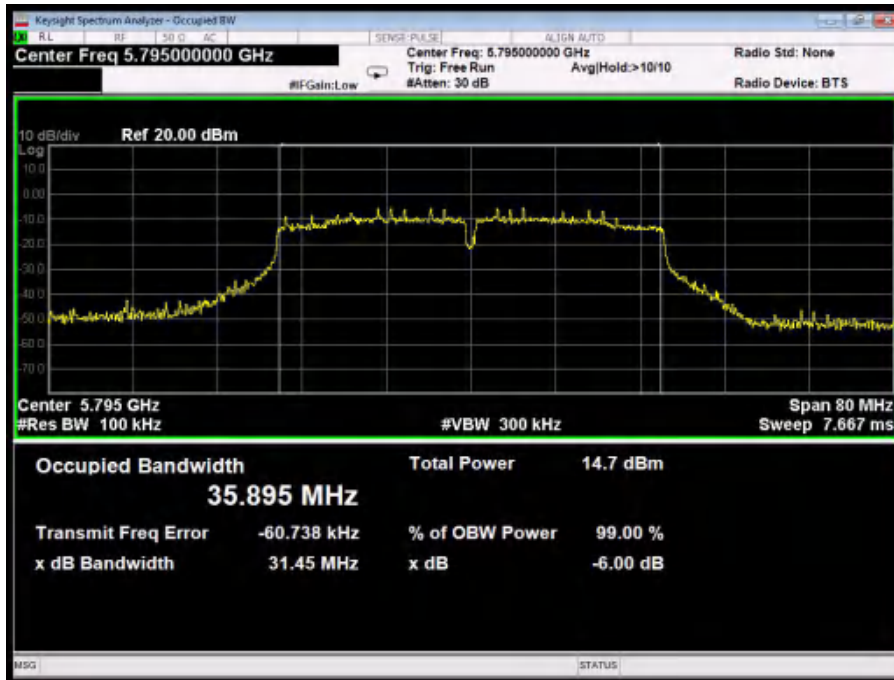

Test Mode: 802.11ac40---High

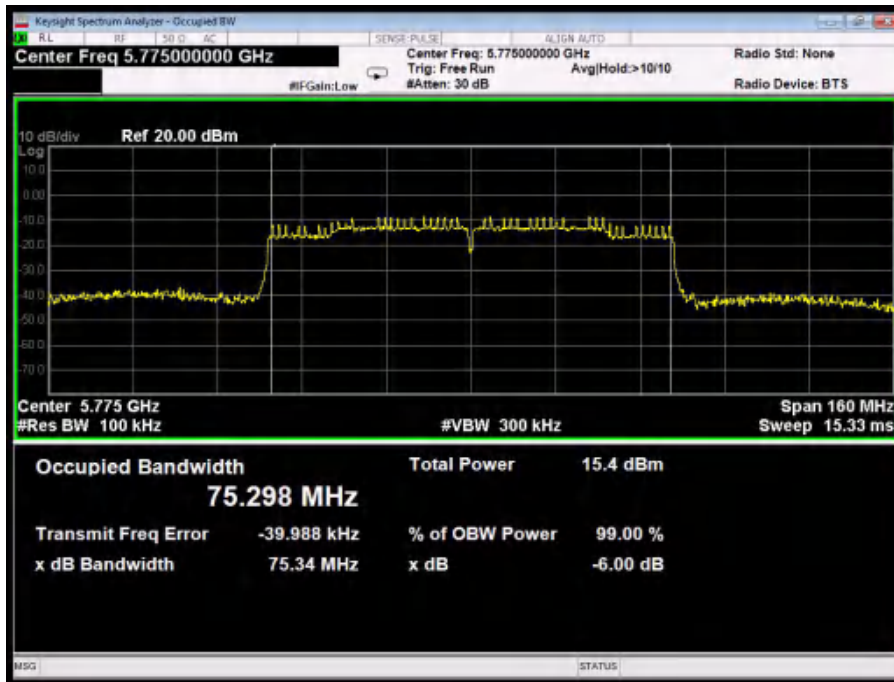

Test Mode: 802.11ac80

26dB & 99% Bandwidth

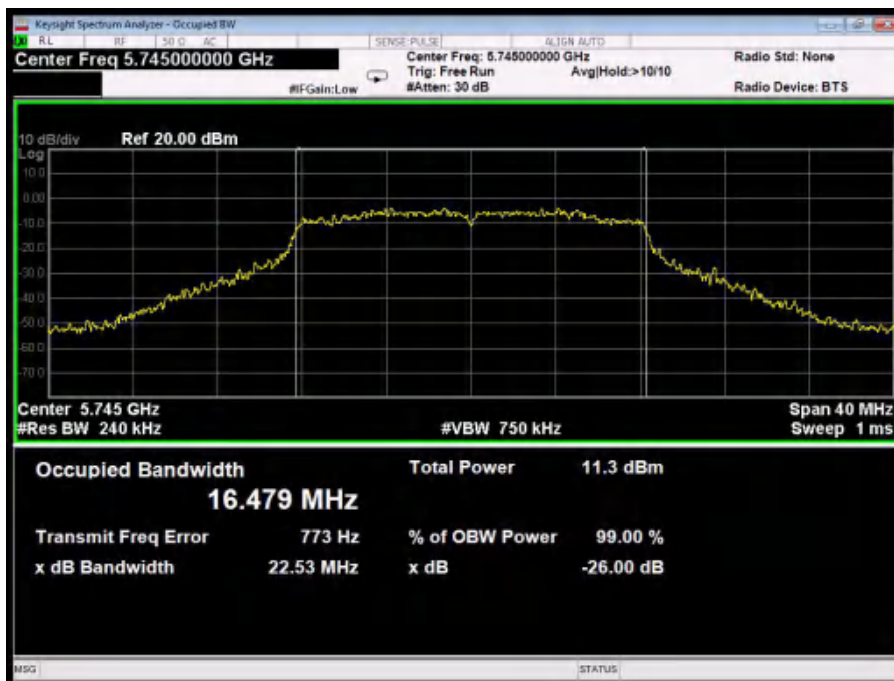

Test Mode: 802.11a--Low

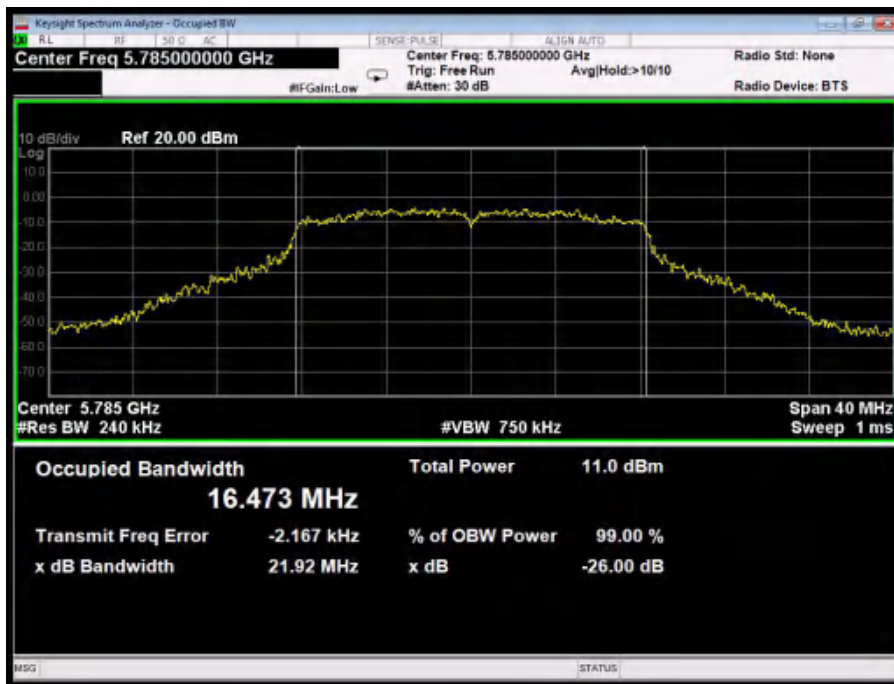

Test Mode: 802.11a---Middle

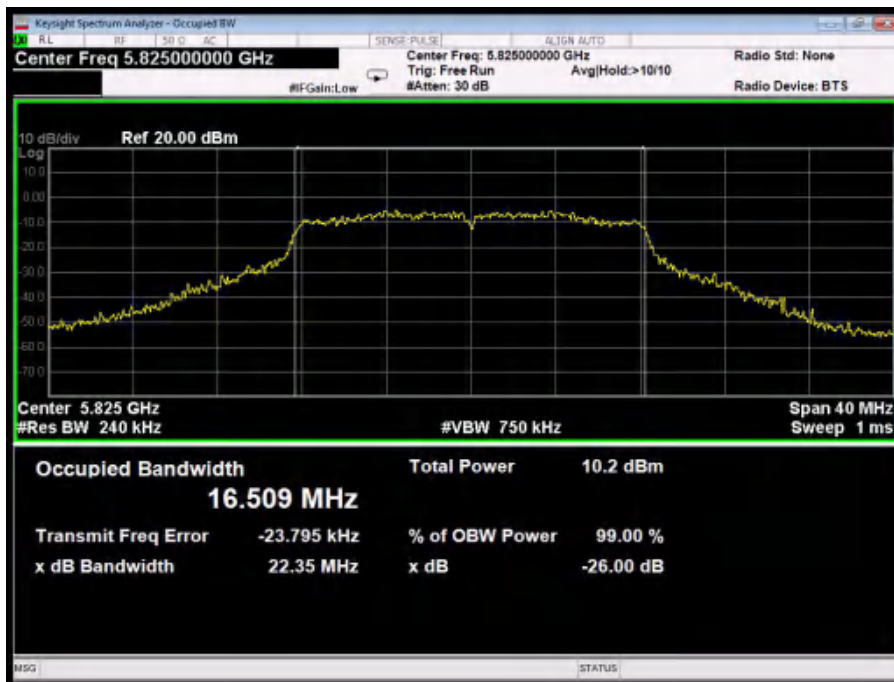

Test Mode: 802.11a---High

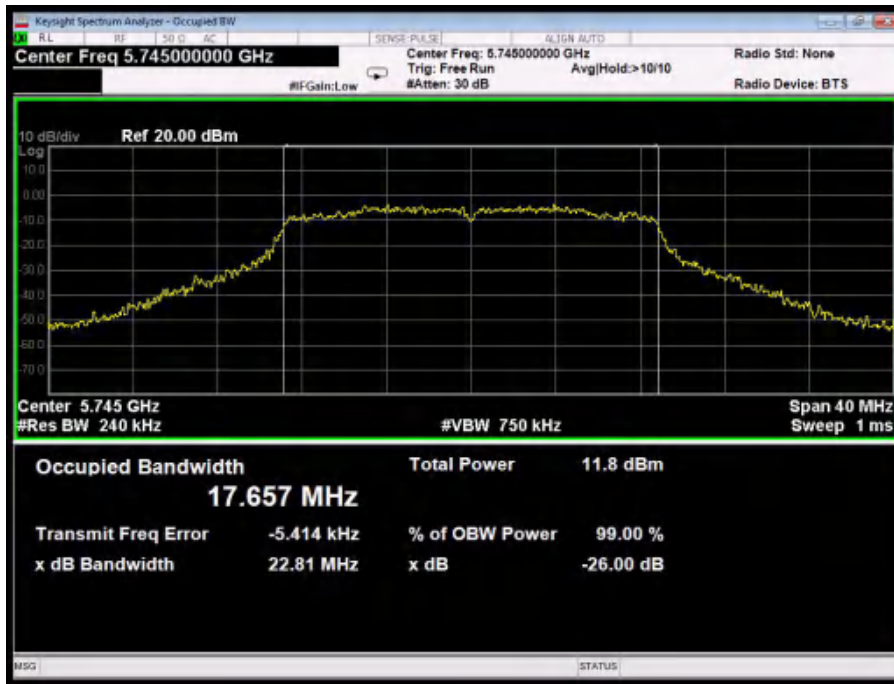

Test Mode: 802.11n20---Low

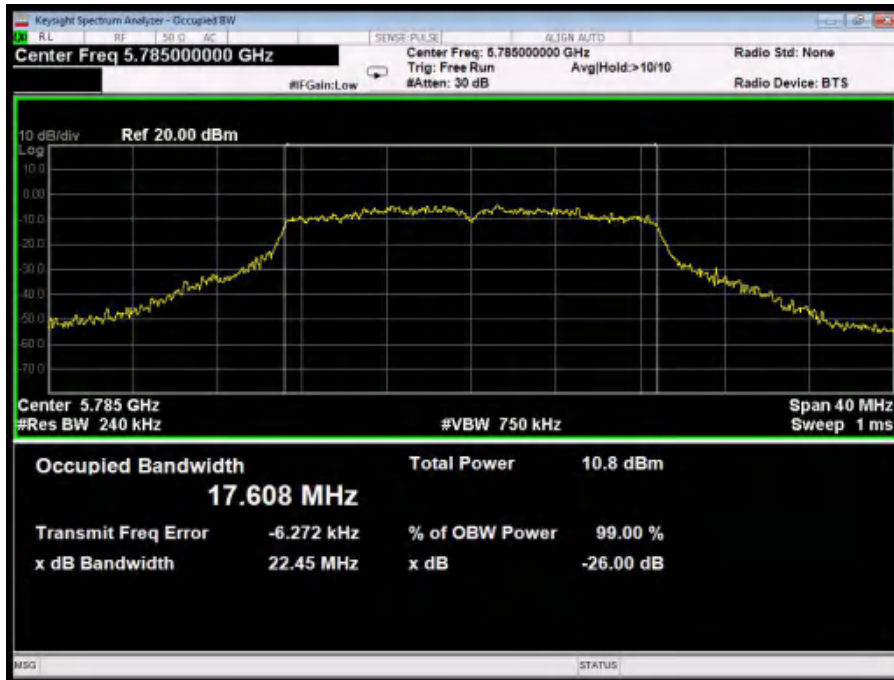

Test Mode: 802.11n20---Middle

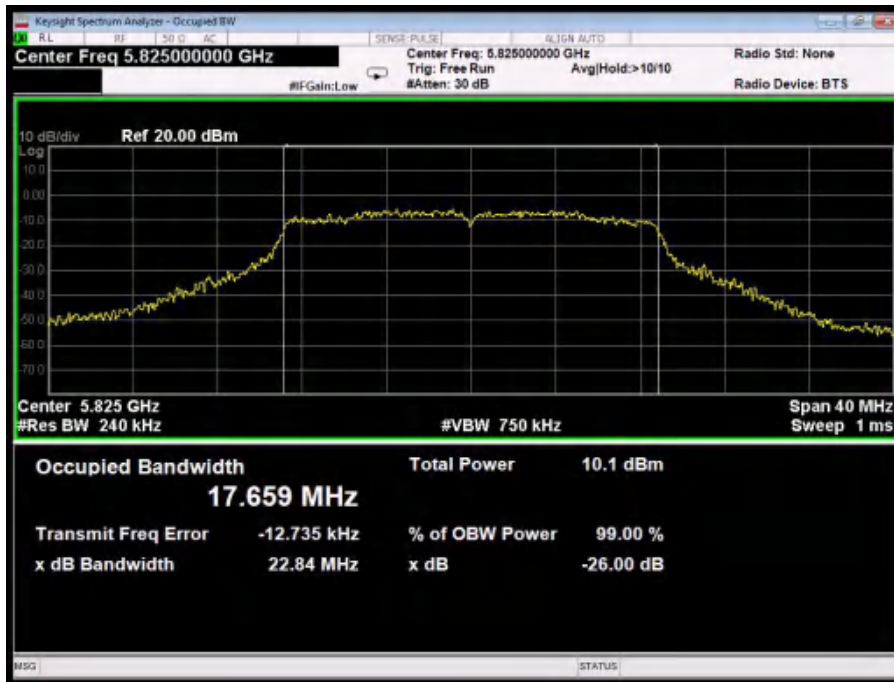

Test Mode: 802.11n20---High

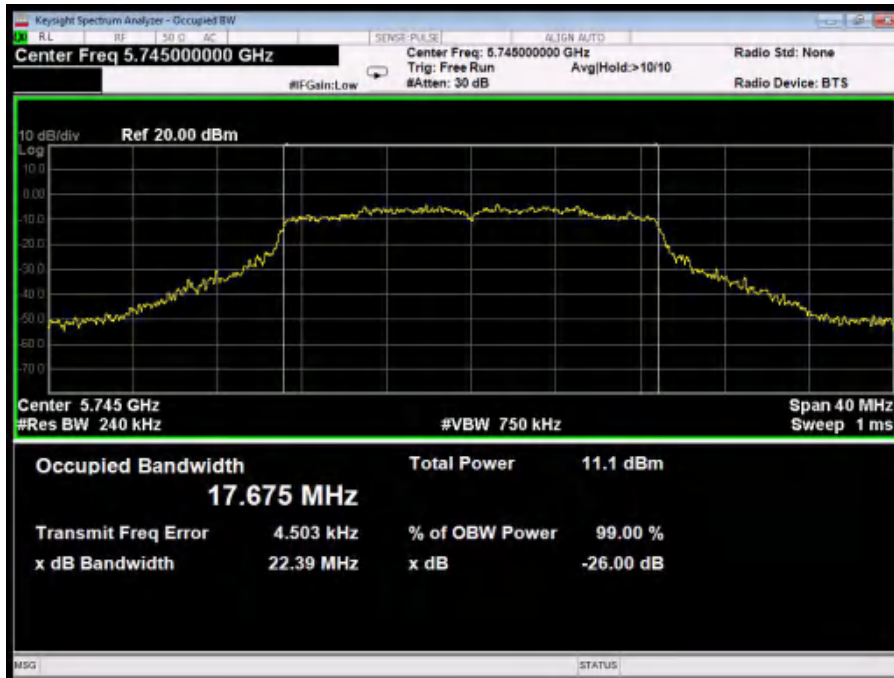

Test Mode: 802.11ac20--Low

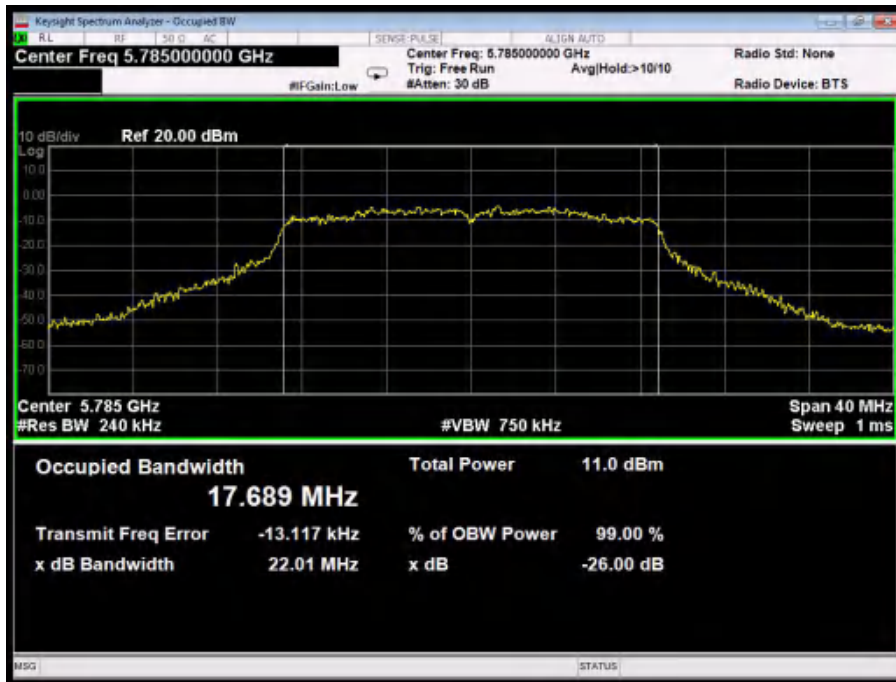

Test Mode: 802.11ac20---Middle

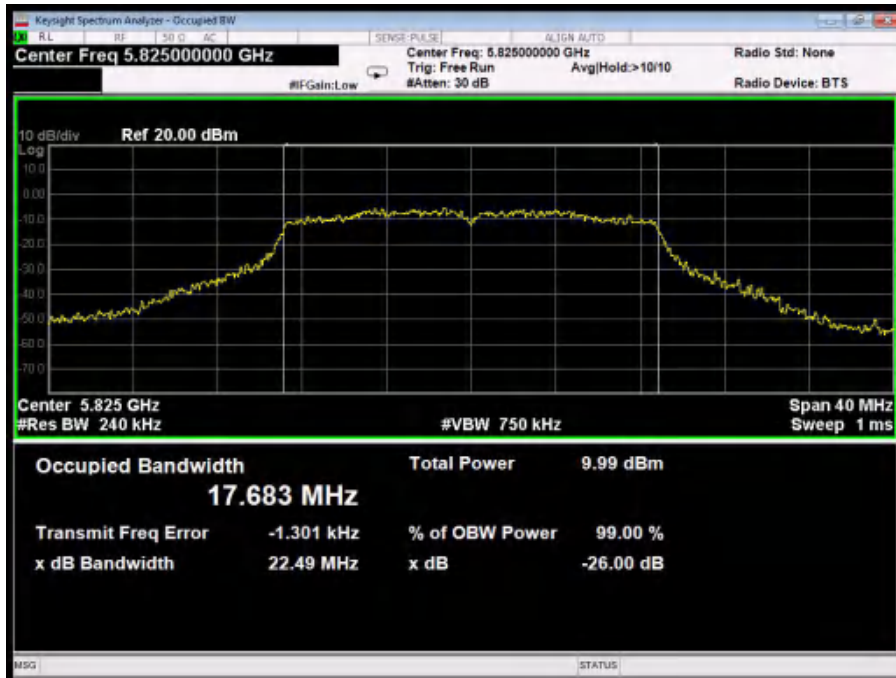

Test Mode: 802.11ac20---High

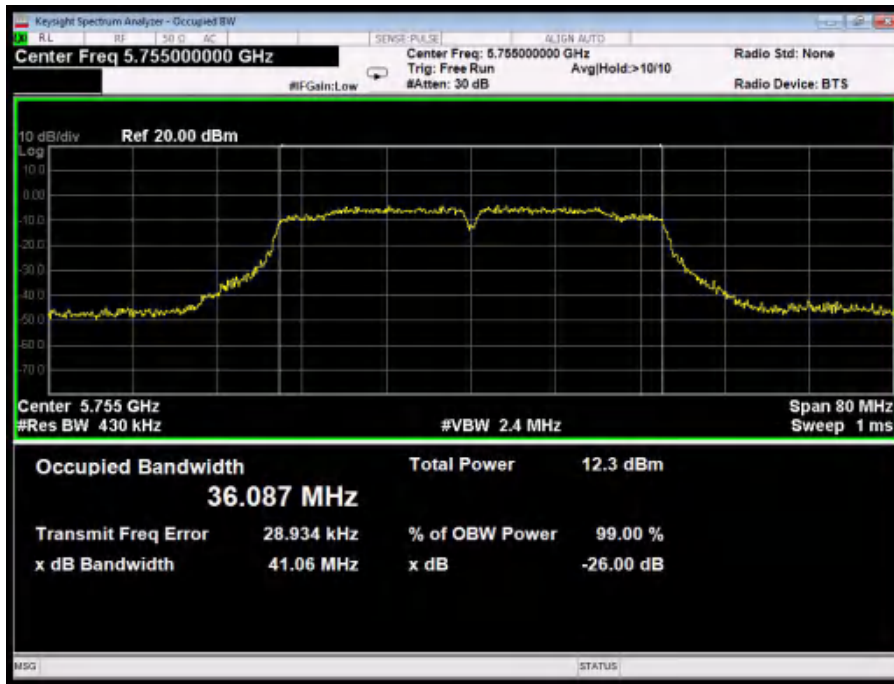

Test Mode: 802.11n40---Low

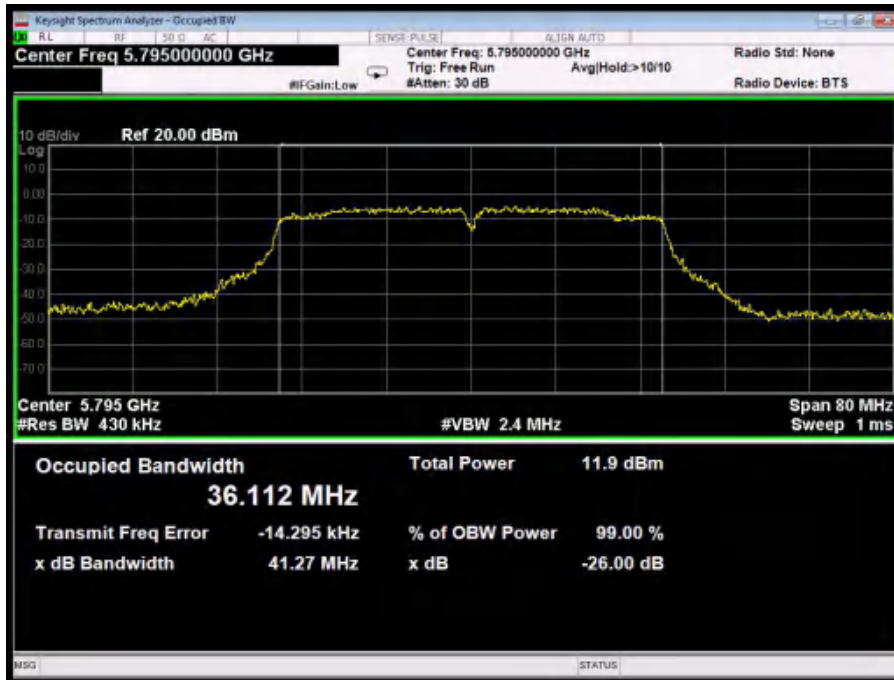

Test Mode: 802.11n40---High

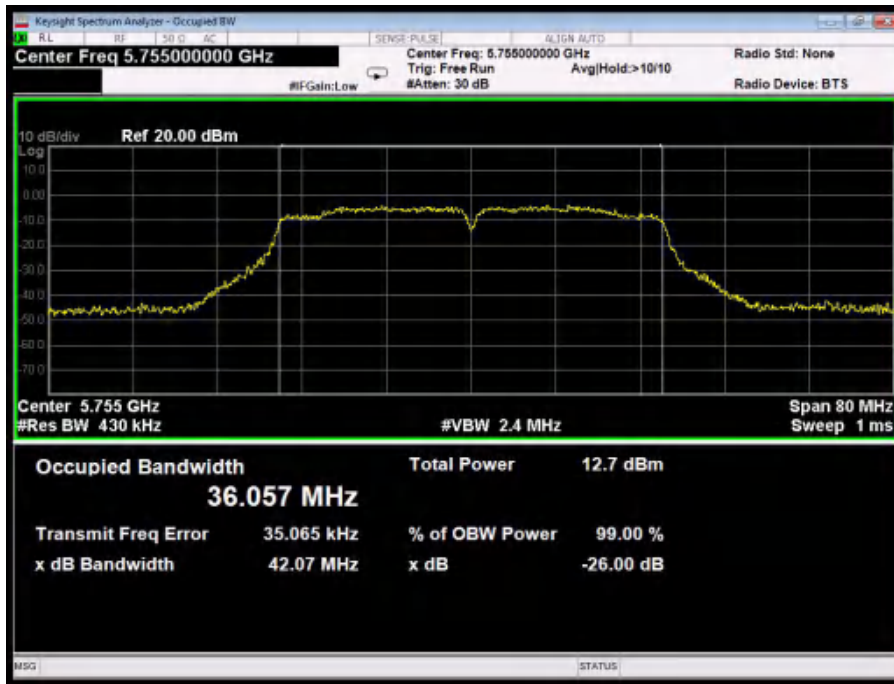

Test Mode: 802.11ac40---Low

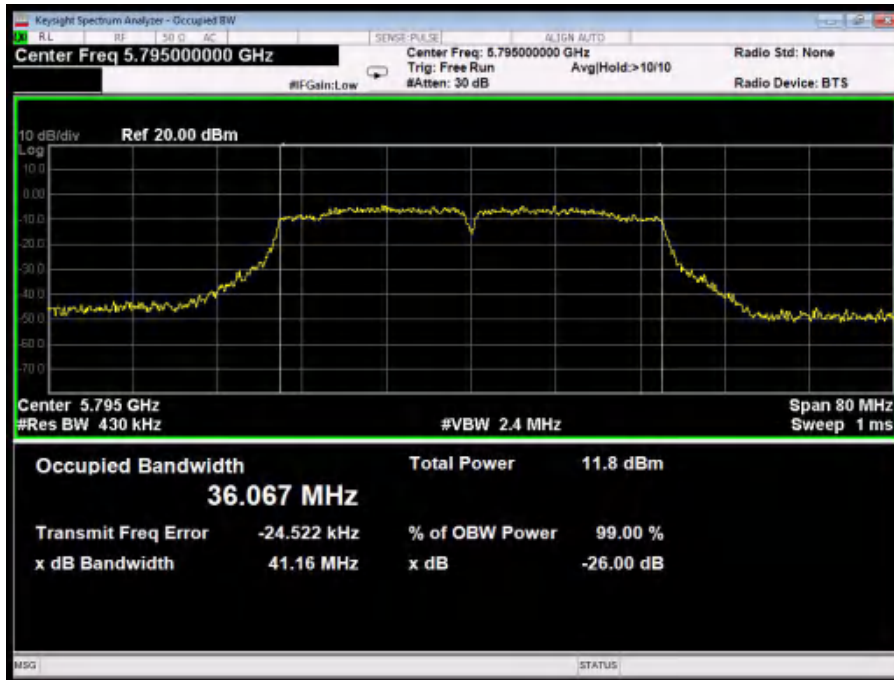

Test Mode: 802.11ac40---High

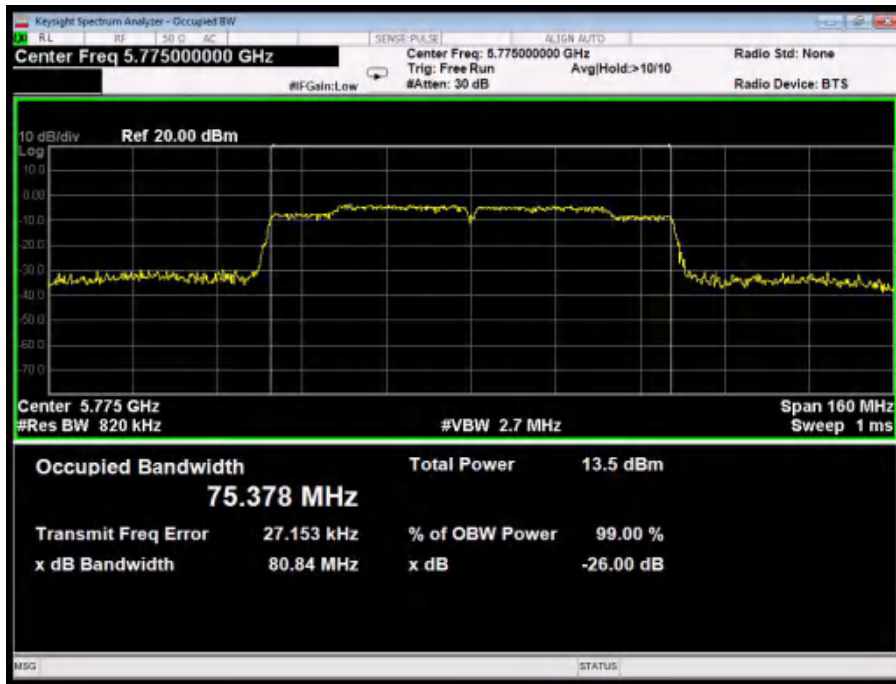

Test Mode: 802.11ac80



9 Power Spectral Density Test

9.1 Test Standard and Limit

Test Standard	FCC Part15 C Section 15.407 (a) (3)
Test Limit	30 dBm/500KHz

9.2 Test Setup

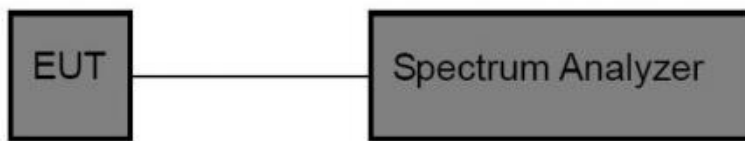

9.3 Test Procedure

For devices operating in the bands 5.15-5.25 GHz, 5.25-5.35 GHz, and 5.47-5.725 GHz, the above procedures make use of 1 MHz RBW to satisfy directly the 1 MHz reference bandwidth specified in § 15.407(a)(5). For devices operating in the band 5.725-5.85 GHz, the rules specify a measurement bandwidth of 500 kHz. Many spectrum analyzers do not have 500 kHz RBW, thus a narrower RBW may need to be used. The rules permit the use of a RBWs less than 1 MHz, or 500 kHz, “provided that the measured power is integrated over the full reference bandwidth” to show the total power over the specified measurement bandwidth (i.e., 1 MHz, or 500 kHz).

1. The EUT is directly connected to the spectrum analyzer;
2. Set RBW =1MHz;
3. Set VBW \geq 3 RBW=3MHz;
3. Set the span to encompass the entire emissions bandwidth (EBW) of the signal;
5. Detector=RMS;
6. Sweep time= auto couple;
7. Trace mode=max. hold;



9.4 Test Data

Test Item	: Power Spectral Density	Test Mode	: CH Low ~ CH High
Test Voltage	: DC 24V	Test Result	: PASS

ANT A:

Mode	Channel Frequency (MHz)	Test Power Spectral Density (dBm/510KHz)	Final Power Spectral Density (dBm/500KHz)	Limit	Results
802.11a	5745	0.847	0.761	30	PASS
	5785	0.924	0.838	30	PASS
	5825	0.268	0.182	30	PASS
802.11n20	5745	0.898	0.812	30	PASS
	5785	1.348	1.262	30	PASS
	5825	1.086	1.000	30	PASS
802.11ac20	5745	1.672	1.586	30	PASS
	5785	0.884	0.798	30	PASS
	5825	1.988	1.902	30	PASS
802.11n40	5755	-1.483	-1.569	30	PASS
	5795	-2.950	-3.036	30	PASS
802.11ac40	5755	-2.532	-2.618	30	PASS
	5795	-2.111	-2.197	30	PASS
802.11ac80	5775	-5.156	-5.242	30	PASS

Remark: Final Power Spectral Density=Test Power Spectral Density+10log10(500/510)



ANT B:

Mode	Channel Frequency (MHz)	Test Power Spectral Density (dBm/510KHz)	Final Power Spectral Density (dBm/500KHz)	Limit	Results
802.11a	5745	-1.867	-1.953	30	PASS
	5785	-2.581	-2.667	30	PASS
	5825	-2.752	-2.838	30	PASS
802.11n20	5745	-2.158	-2.244	30	PASS
	5785	-3.253	-3.339	30	PASS
	5825	-3.606	-3.692	30	PASS
802.11ac20	5745	-2.65	-2.736	30	PASS
	5785	-3.215	-3.301	30	PASS
	5825	-3.963	-4.049	30	PASS
802.11n40	5755	-5.282	-5.368	30	PASS
	5795	-5.308	-5.394	30	PASS
802.11ac40	5755	-5.199	-5.285	30	PASS
	5795	-5.335	-5.421	30	PASS
802.11ac80	5775	-7.938	-8.021	30	PASS

Remark: Final Power Spectral Density=Test Power Spectral Density+10log10(500/510)



ANT A+B

Mode	Channel Frequency (MHz)	Final Power Spectral Density (dBm/510KHz)	Final Power Spectral Density (dBm/500KHz)	Limit	Results
802.11a	5745	5.87	5.784	29.99	PASS
	5785	5.79	5.704	29.99	PASS
	5825	5.56	5.474	29.99	PASS
802.11n20	5745	5.84	5.754	29.99	PASS
	5785	5.84	5.754	29.99	PASS
	5825	5.71	5.624	29.99	PASS
802.11ac20	5745	6.03	5.944	29.99	PASS
	5785	5.69	5.604	29.99	PASS
	5825	6.00	5.914	29.99	PASS
802.11n40	5755	4.78	4.694	29.99	PASS
	5795	4.47	4.384	29.99	PASS
802.11ac40	5755	4.56	4.474	29.99	PASS
	5795	4.64	4.554	29.99	PASS
802.11ac80	5775	3.92	3.834	29.99	PASS

Remark: Final Power Spectral Density=Test Power Spectral Density+10log10(500/510)



ANT A

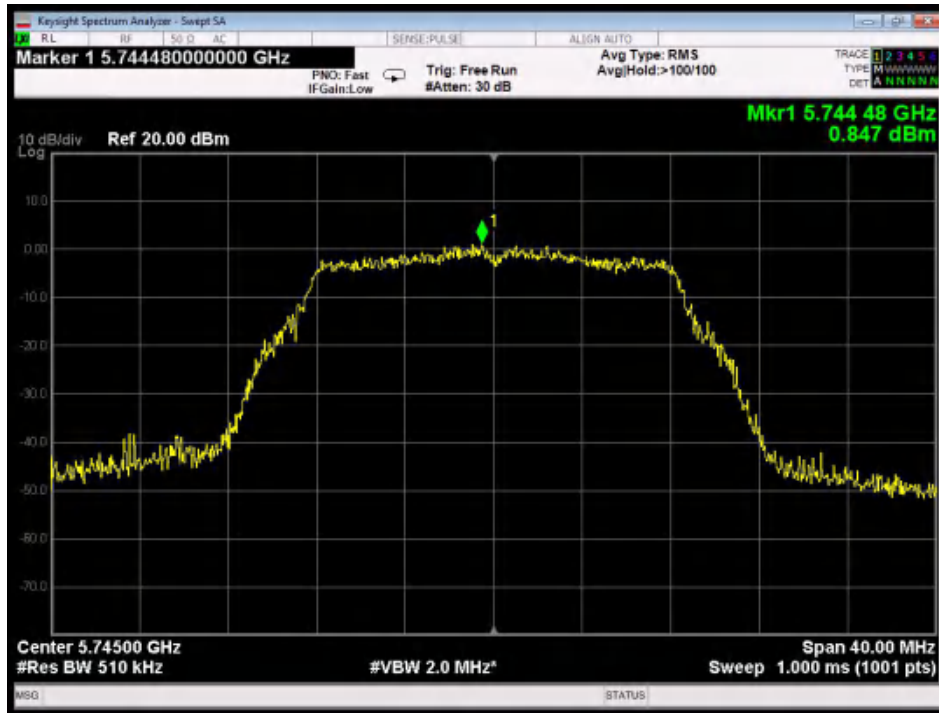

Test Mode: 802.11a--Low

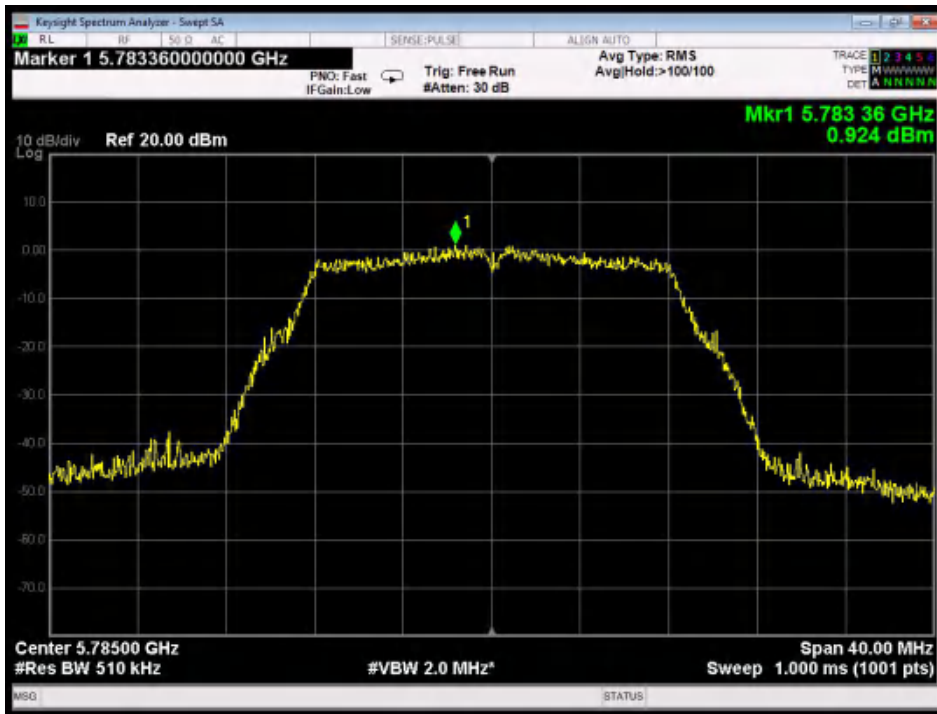

Test Mode: 802.11a---Middle

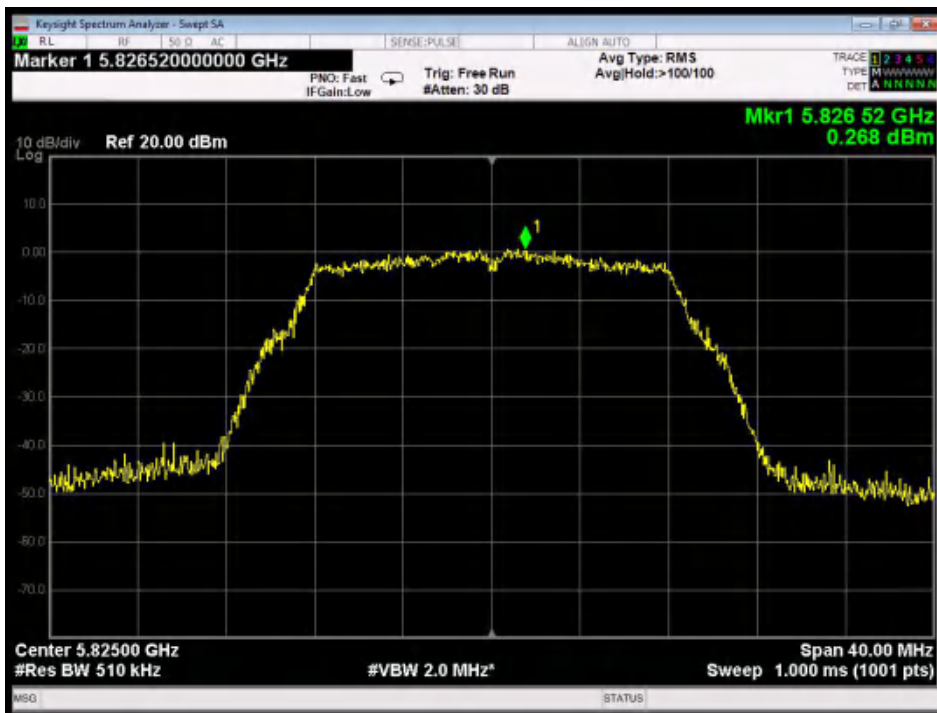

Test Mode: 802.11a---High

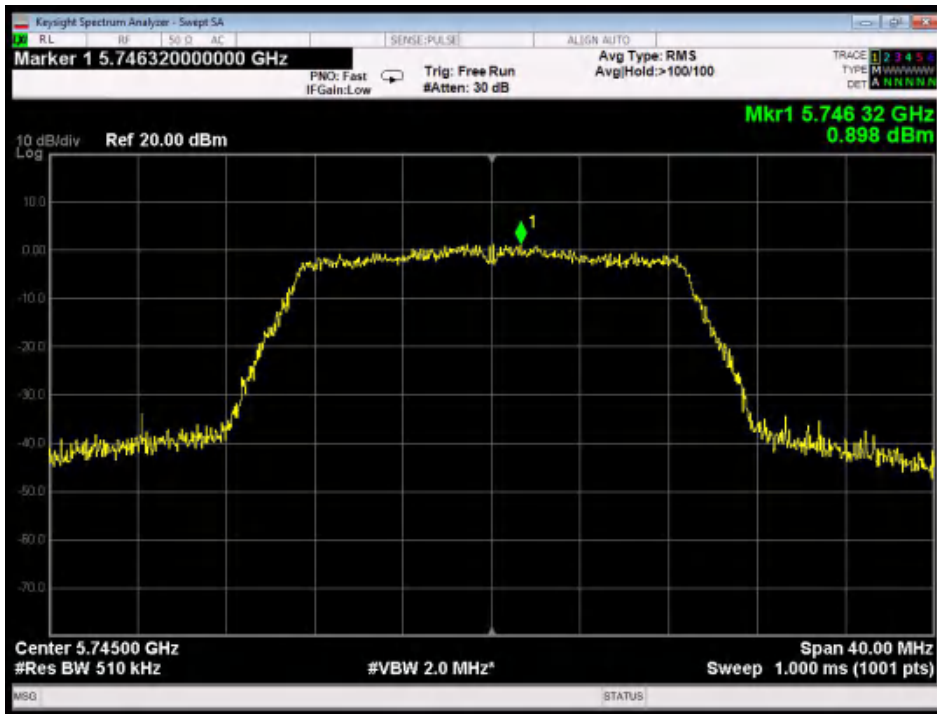

Test Mode: 802.11n20---Low

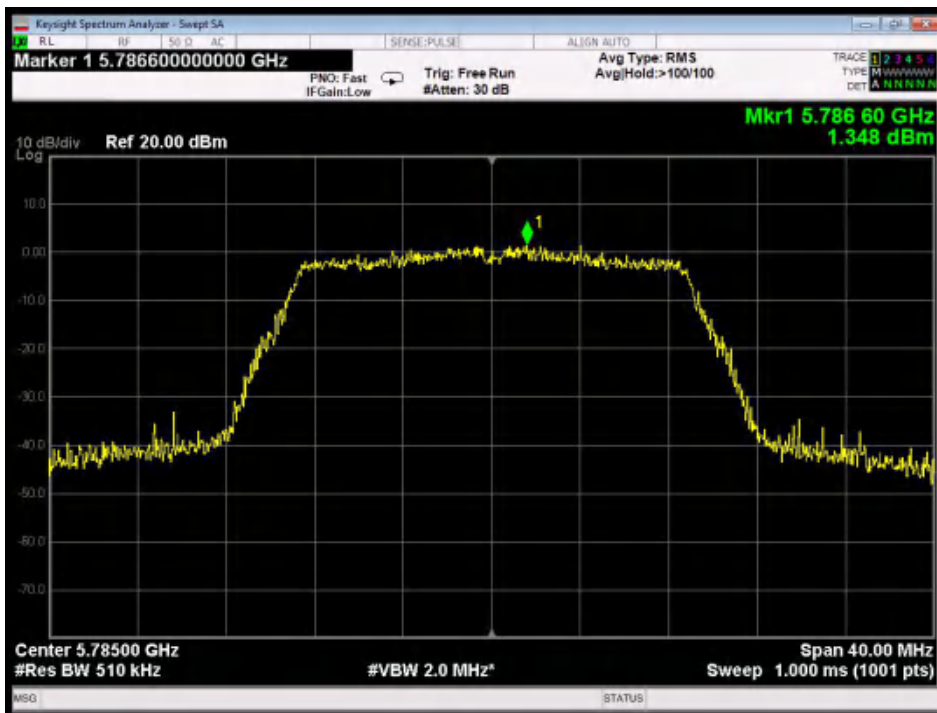

Test Mode: 802.11n20---Middle

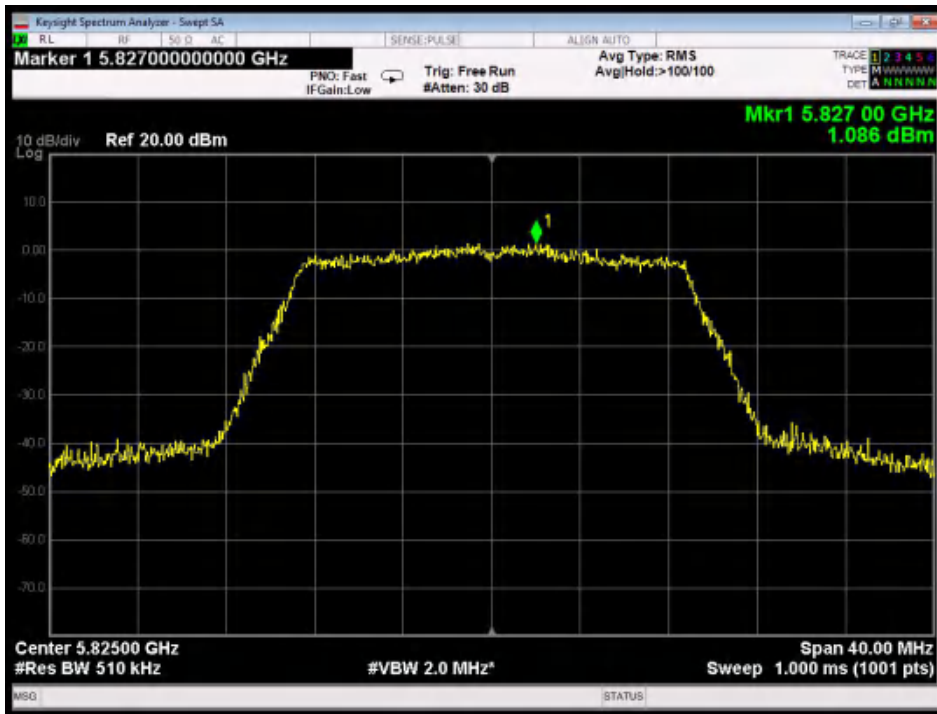

Test Mode: 802.11n20---High

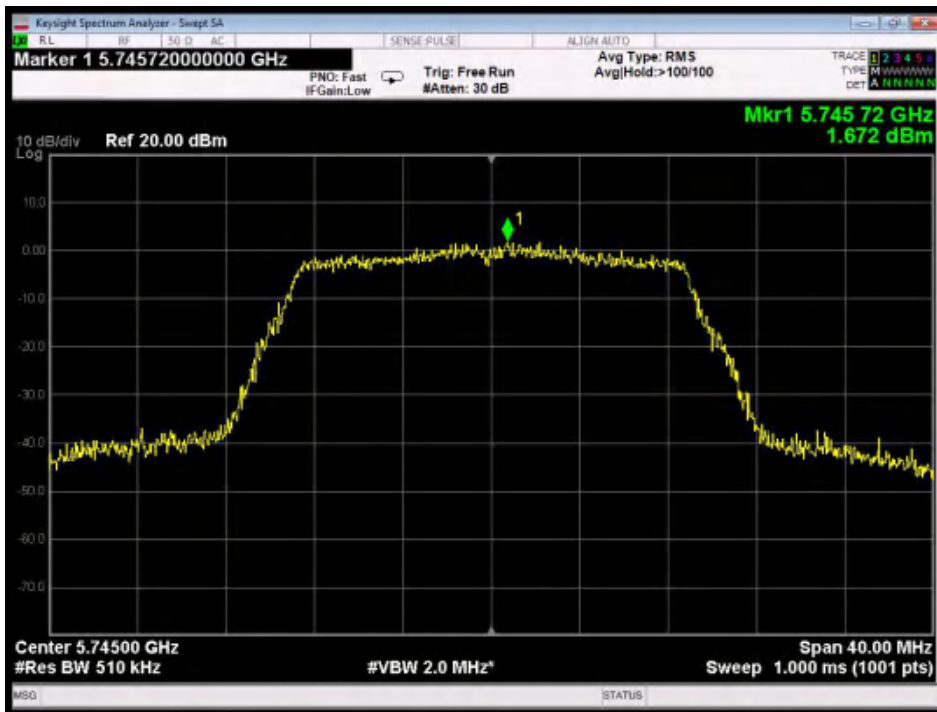



Test Mode: 802.11ac20--Low

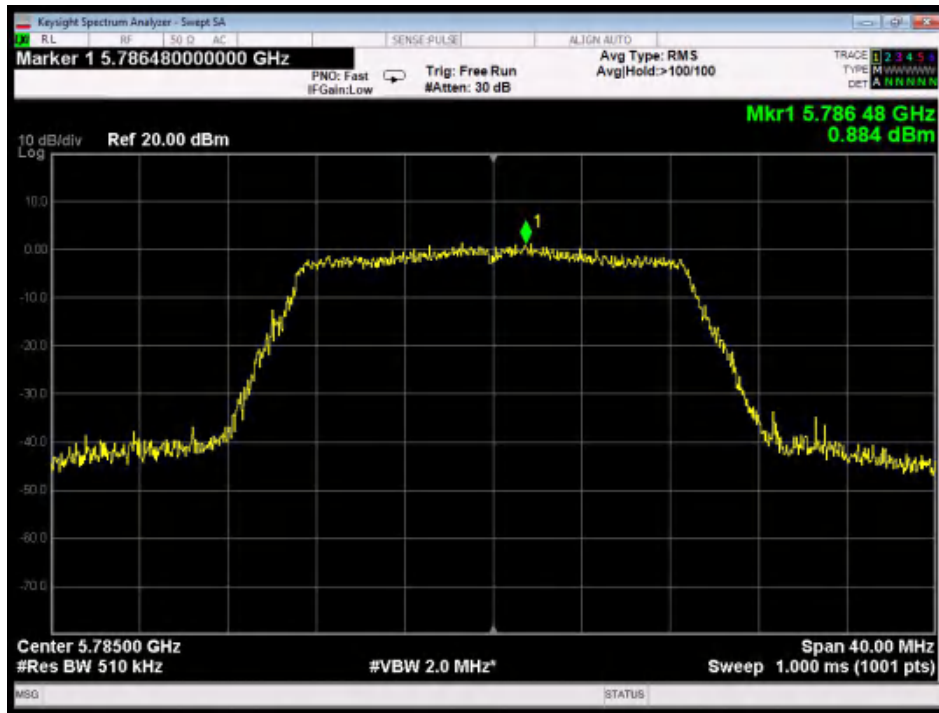

Test Mode: 802.11ac20---Middle

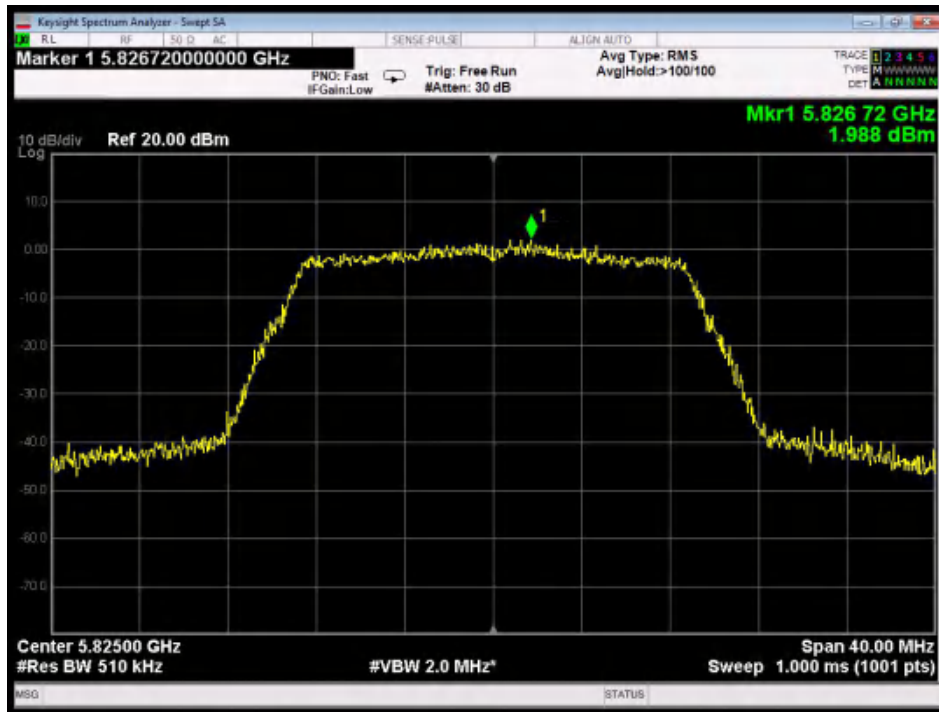



Test Mode: 802.11ac20---High

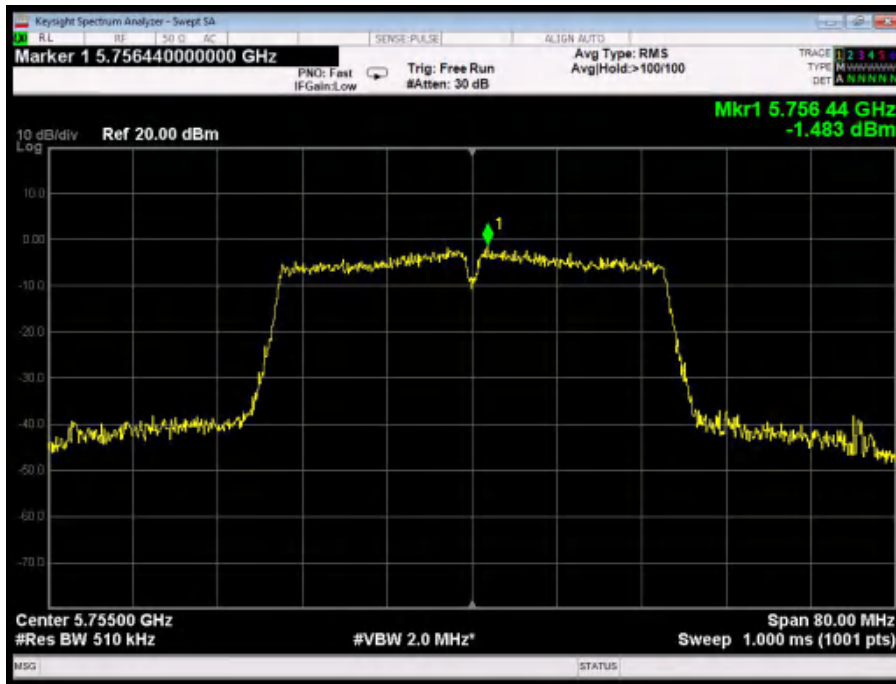

Test Mode: 802.11n40---Low

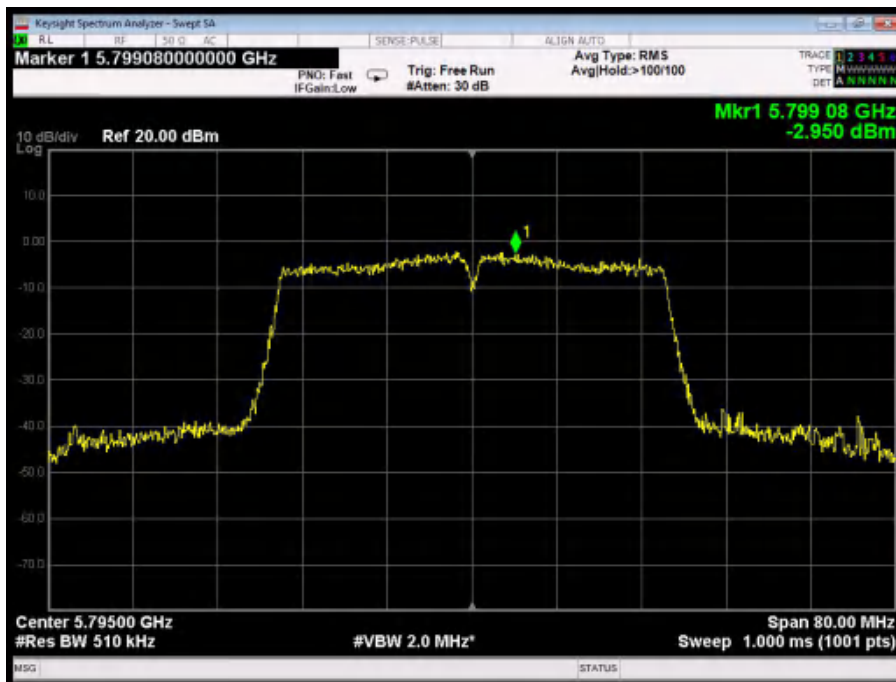



Test Mode: 802.11n40---High

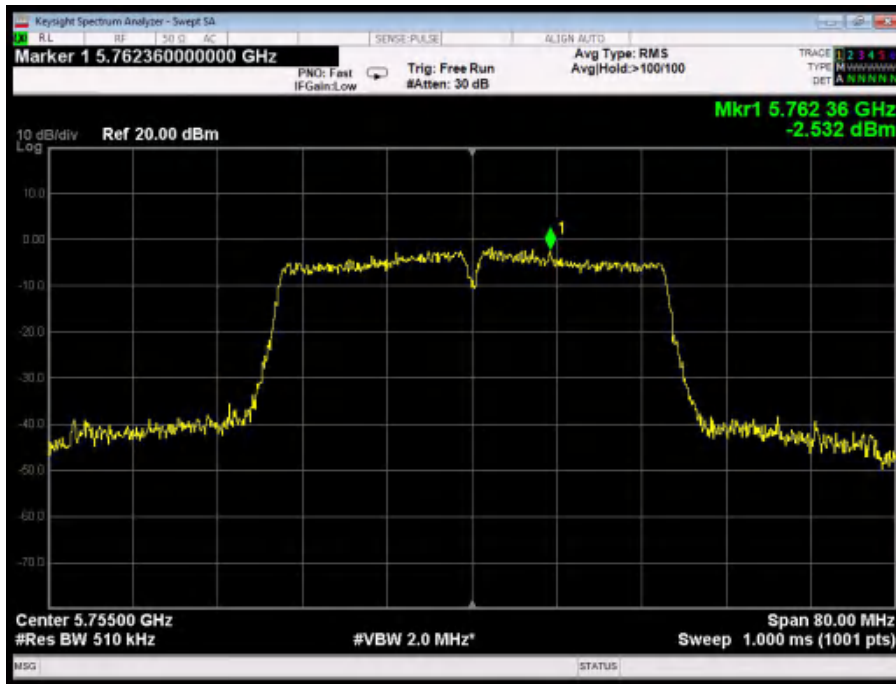

Test Mode: 802.11ac40---Low

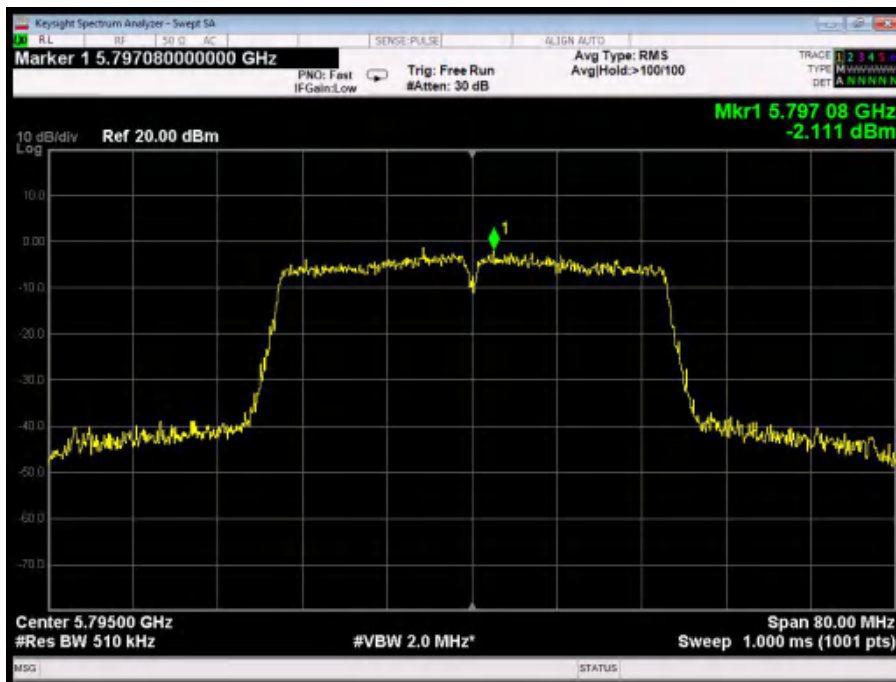



Test Mode: 802.11ac40---High

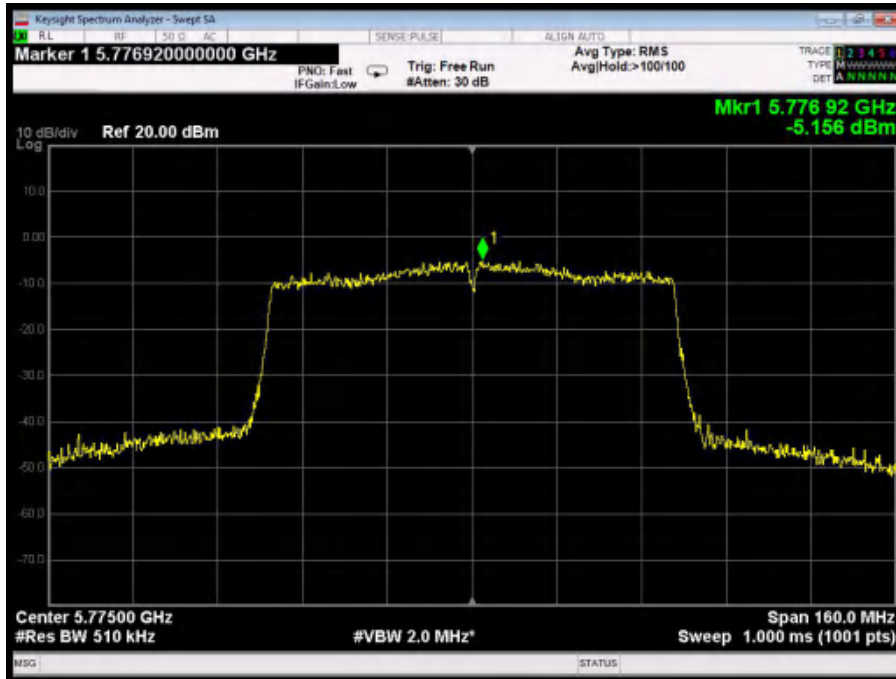

Test Mode: 802.11ac80



ANT B

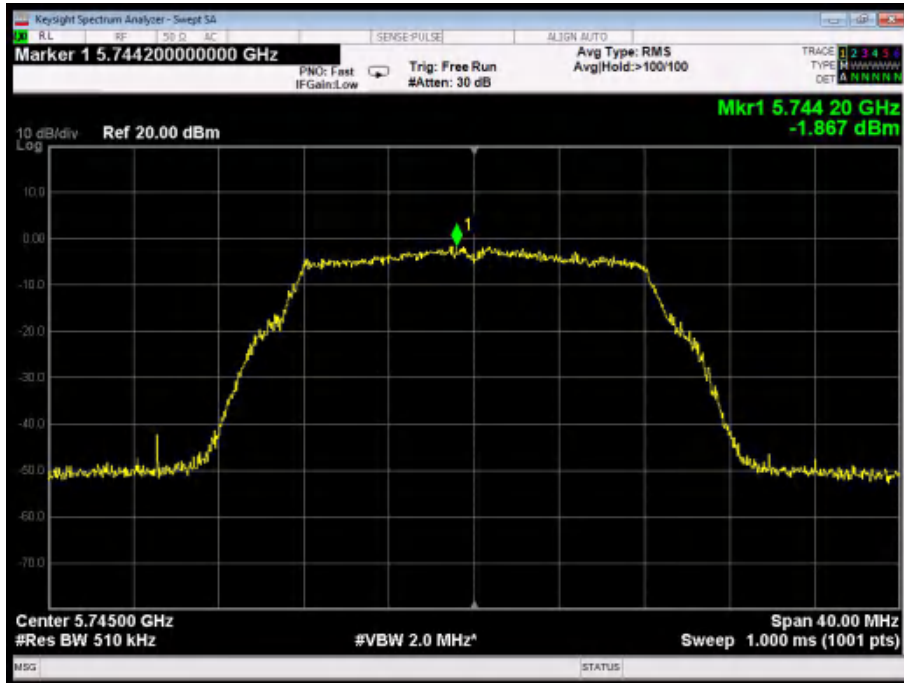

Test Mode: 802.11a--Low

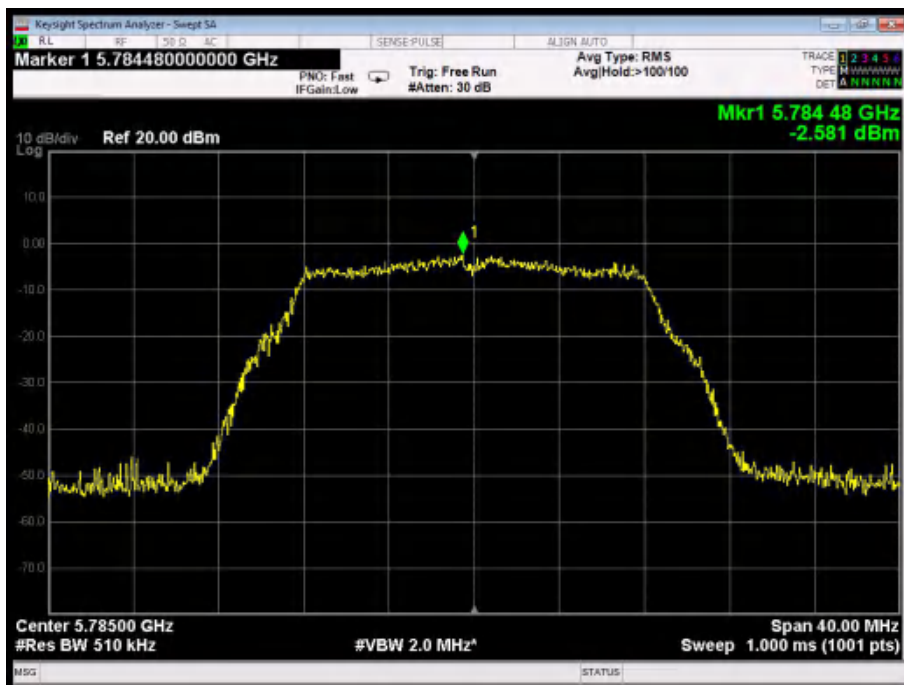



Test Mode: 802.11a---Middle

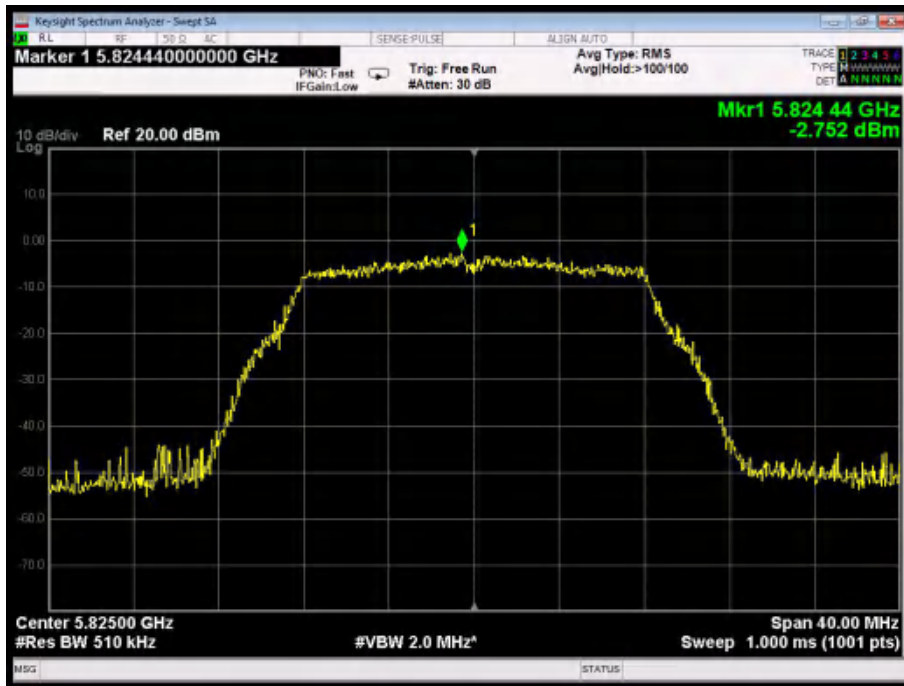

Test Mode: 802.11a---High

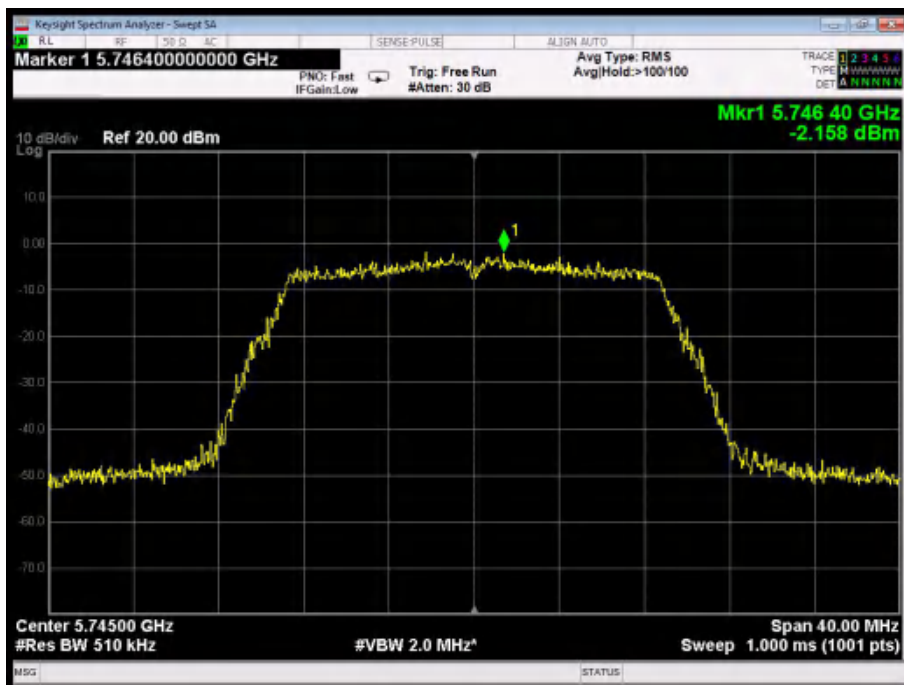



Test Mode: 802.11n20---Low

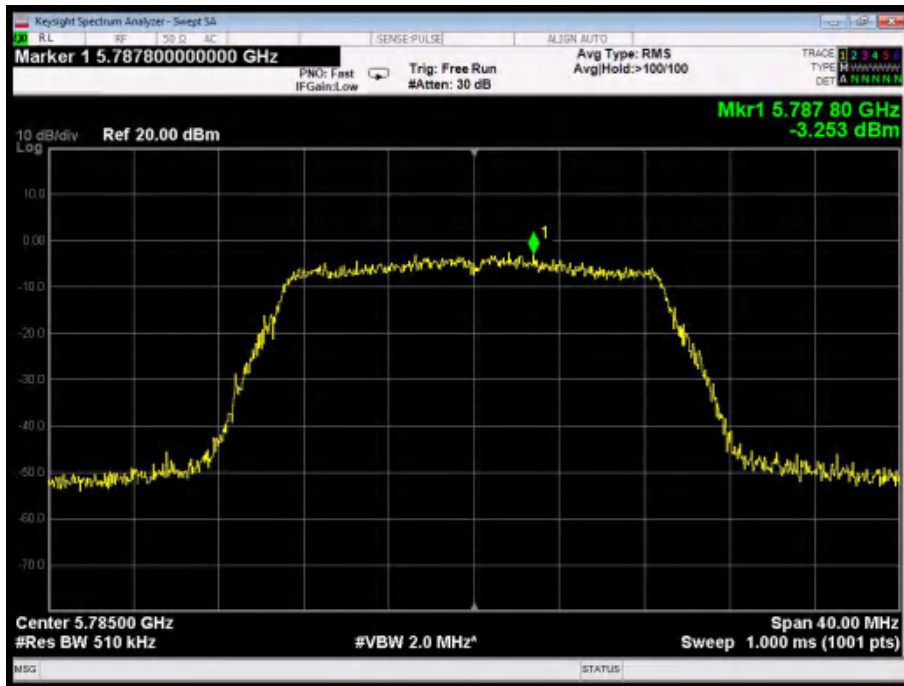

Test Mode: 802.11n20---Middle

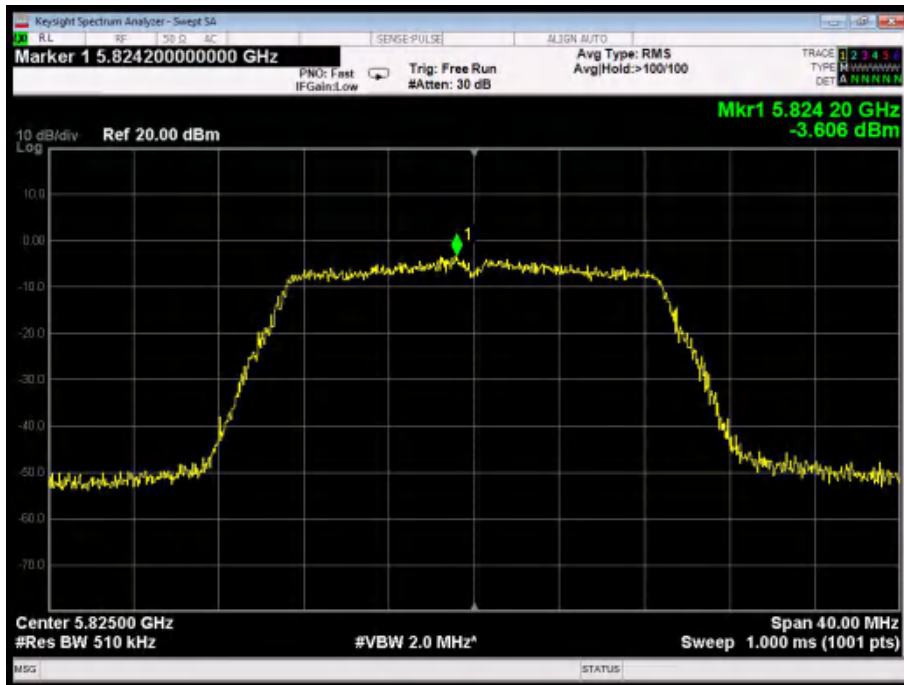

Test Mode: 802.11n20---High

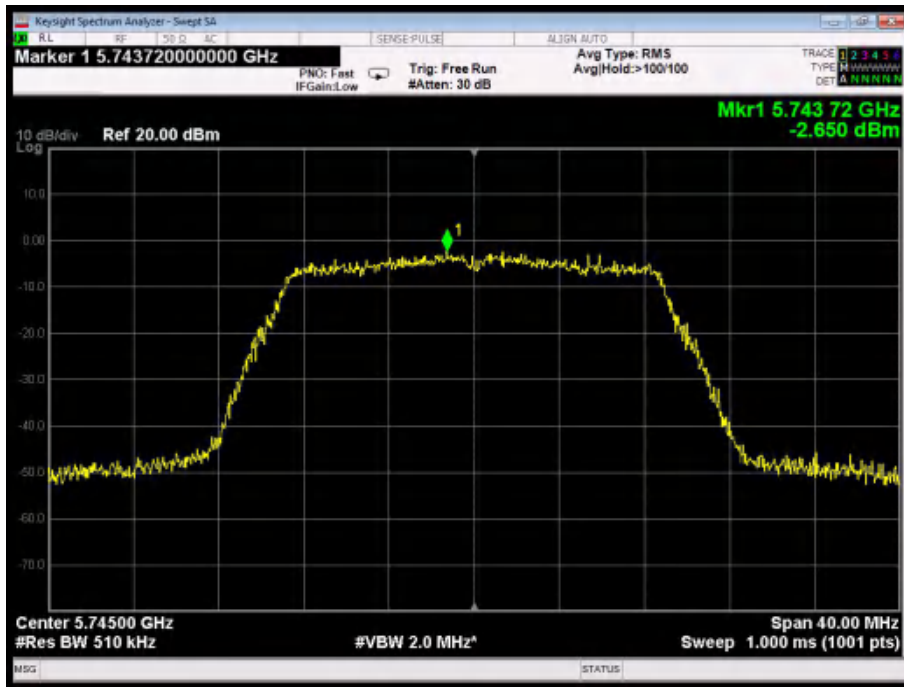

Test Mode: 802.11ac20--Low

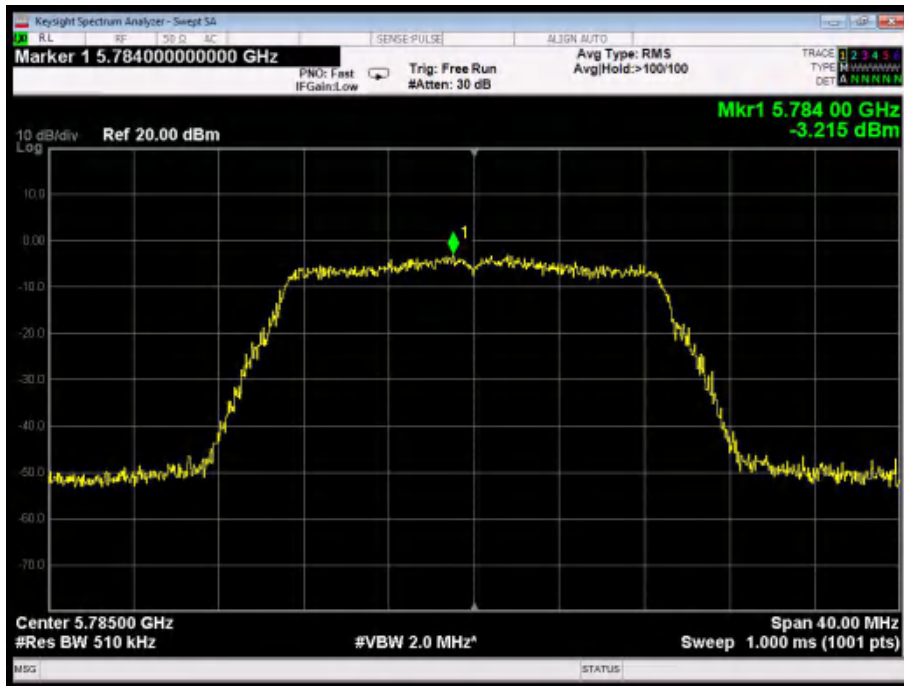

Test Mode: 802.11ac20---Middle

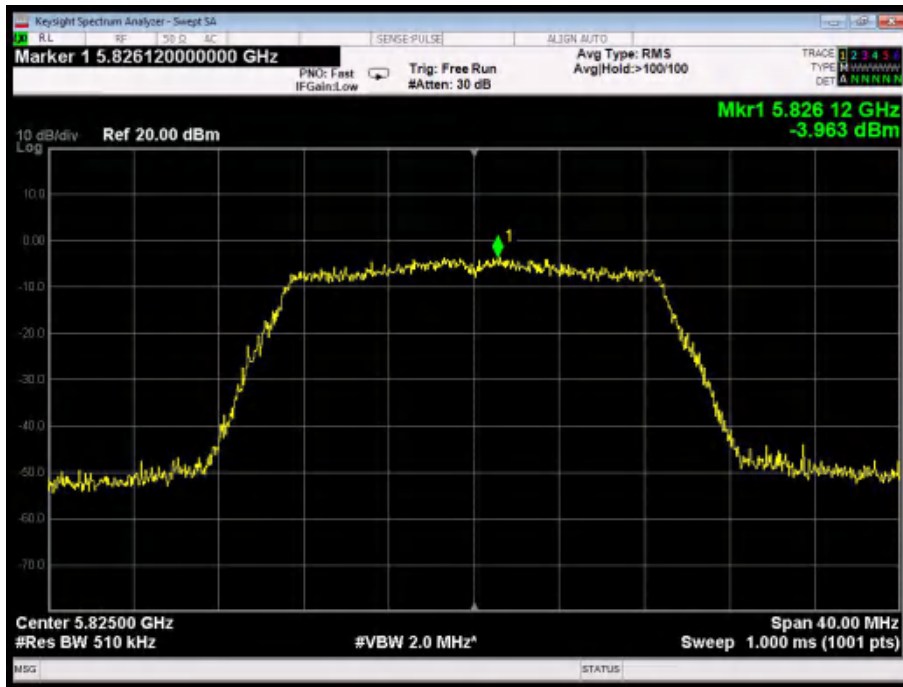

Test Mode: 802.11ac20---High

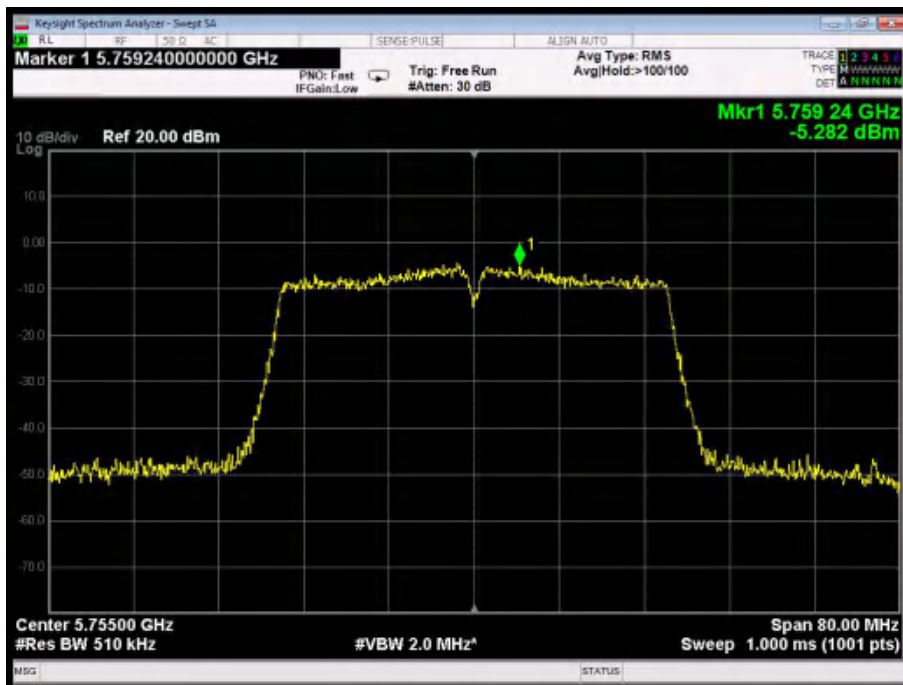

Test Mode: 802.11n40---Low

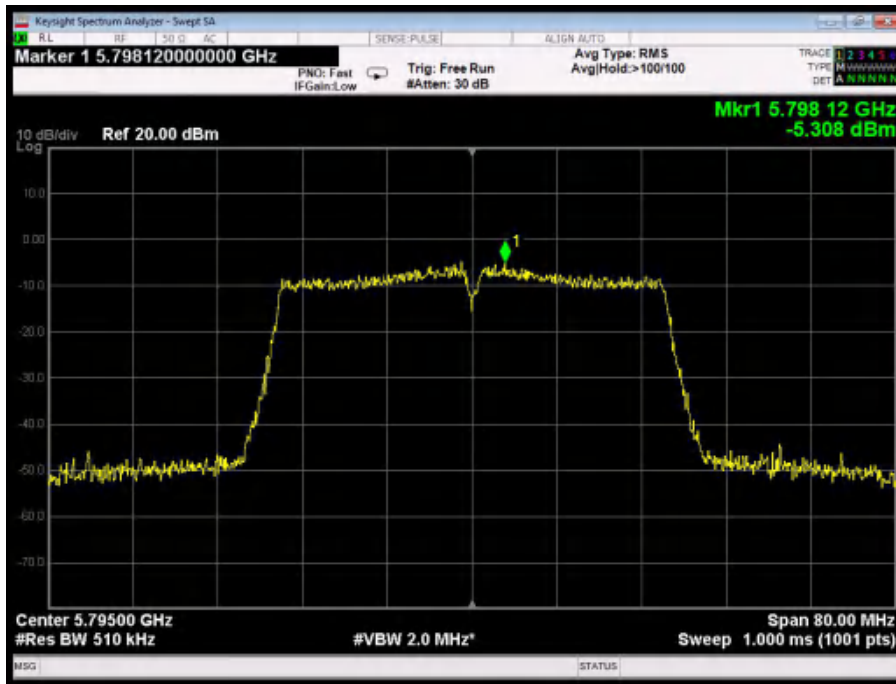

Test Mode: 802.11n40---High

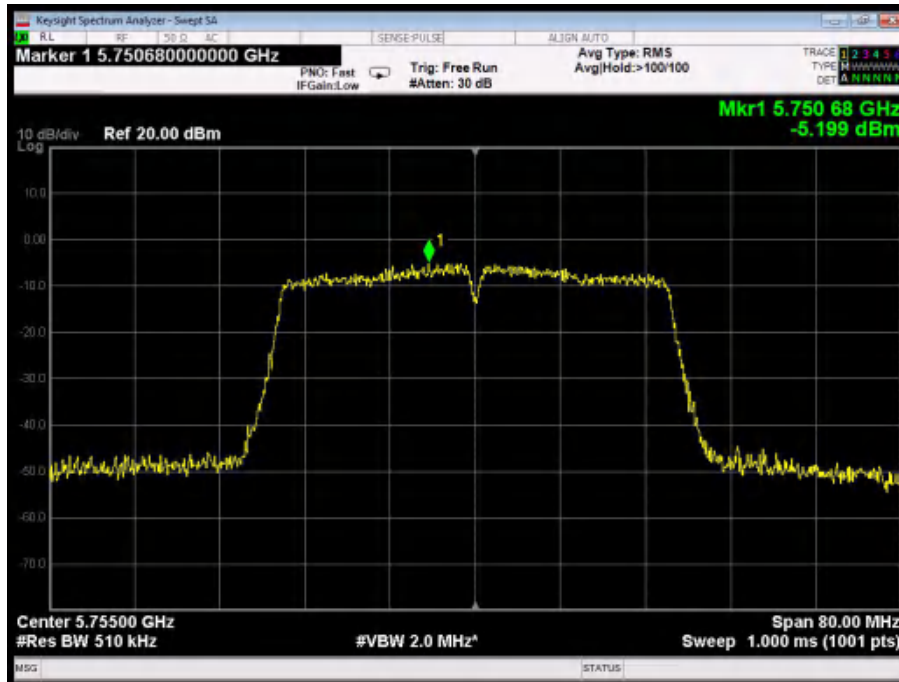

Test Mode: 802.11ac40---Low

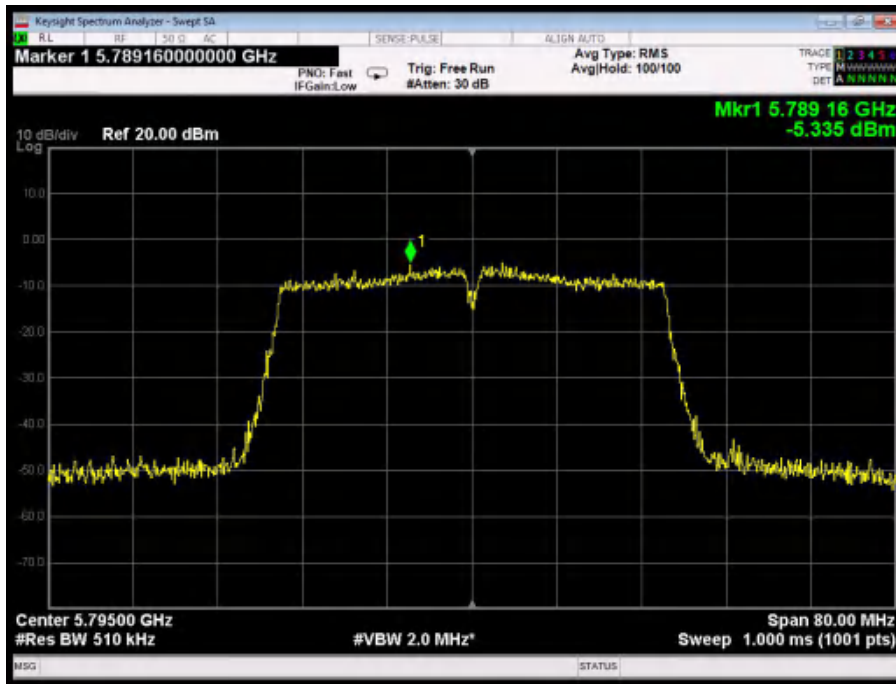

Test Mode: 802.11ac40---High

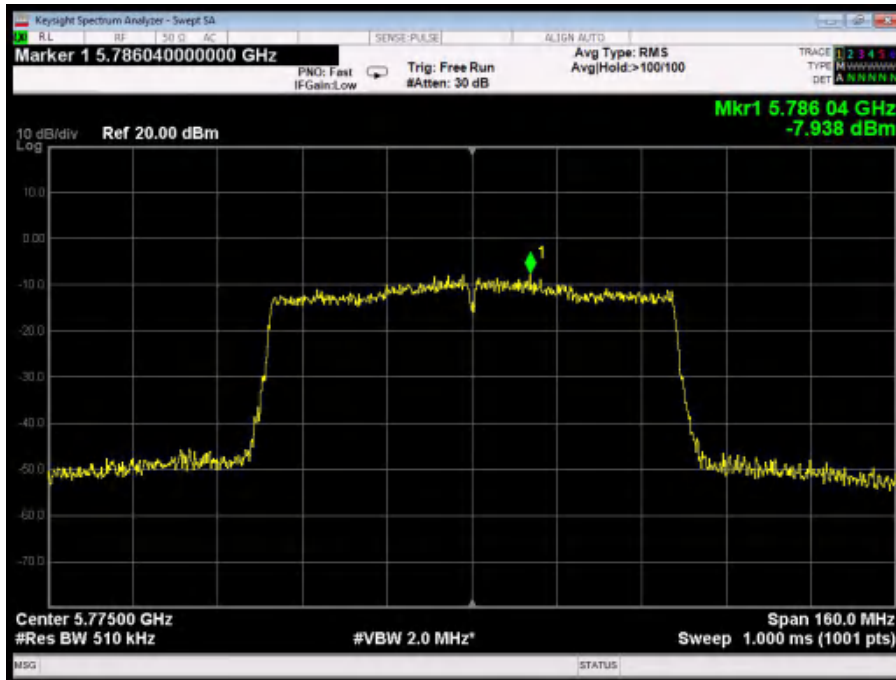

Test Mode: 802.11ac80



10 Antenna Requirement

10.1 Test Standard and Requirement

Test Standard	FCC Part15 Section 15.203 /15.407
Requirement	<p>1) 15.203 requirement:</p> <p>An intentional radiator shall be designed to ensure that no antenna other than that furnished by the responsible party shall be used with the device. The use of a permanently attached antenna or of an antenna that uses a unique coupling to the intentional radiator, the manufacturer may design the unit so that a broken antenna can be replaced by the user, but the use of a standard antenna jack or electrical connector is prohibited.</p> <p>2) 15.407 requirement:</p> <p>An intentional radiator shall be designed to ensure that no antenna other than that furnished by the responsible party shall be used with the device. The use of a permanently attached antenna or of an antenna that uses a unique coupling to the intentional radiator shall be considered sufficient to comply with the provisions of this section. The manufacturer may design the unit so that a broken antenna can be replaced by the user, but the use of a standard antenna jack or electrical connector is prohibited. This requirement does not apply to carrier current devices or to devices operated under the provisions of §15.211, §15.213, §15.217, §15.219, or §15.221. Further, this requirement does not apply to intentional radiators that must be professionally installed, such as perimeter protection systems and some field disturbance sensors, or to other intentional radiators which, in accordance with §15.31(d), must be measured at the installation site. However, the installer shall be responsible for ensuring that the proper antenna is employed so that the limits in this part are not exceeded.</p>

10.2 Antenna Connected Construction

The antenna is a PIFA Antenna which permanently attached, and the best case gain of the antenna is 3 dBi. It complies with the standard requirement.

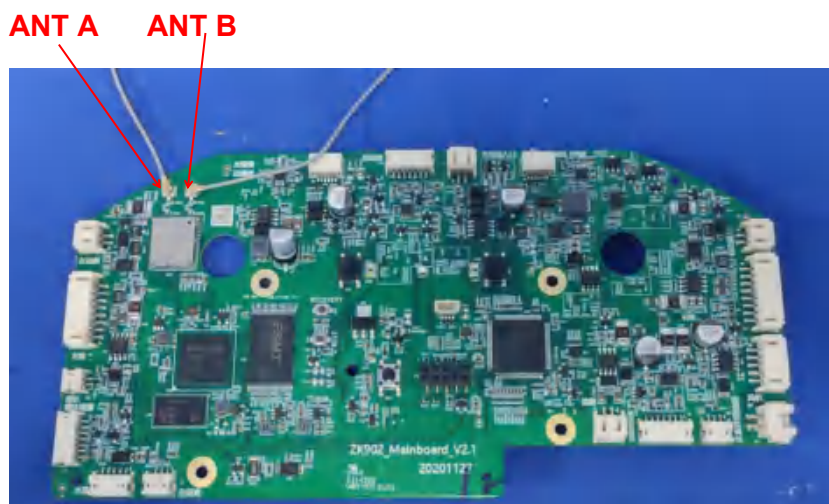

11 APPENDIX I -- PHOTOGRAPH

Reference to the test report PTC21011300402E-FC03

----- End of Report -----