SAR Test Report

Report No.: AGC03576190601FH01

FCC ID : 2ATSO-HYP10

APPLICATION PURPOSE : Original Equipment

PRODUCT DESIGNATION : Portable Translator

BRAND NAME : World Speak

MODEL NAME : HYP10

APPLICANT : King Jim Co., Ltd.

DATE OF ISSUE : July 29,2019

STANDARD(S) : IEEE Std. 1528:2013
FCC 47 CFR Part 2§2.1093:2013
IEEE C95.1TM:2005

REPORT VERSION : V1.0

Attestation of Global Compliance(Shenzhen) Co., Ltd.

CAUTION:

This report shall not be reproduced except in full without the written permission of the test laboratory and shall not be quoted out of context.



Attestation of Global Compliance(Shenzhen)Co.,Ltd.

Add: 2/F., Building 2, No.1-4, Chaxi Sanwei Technical Industrial Park, Gushu,
Xixiang, Bao'an District, Shenzhen, Guangdong, China

Tel: +86-755 2523 4088

E-mail: agc@agc-cert.com

Service Hotline:400 089 2118

Report Revise Record

Report Version	Revise Time	Issued Date	Valid Version	Notes
V1.0	/	July 29,2019	Valid	Initial Release



Attestation of Global Compliance(Shenzhen)Co.,Ltd.

Add: 2/F., Building 2, No.1-4, Chaxi Sanwei Technical Industrial Park, Gushu,
Xixiang, Bao'an District, Shenzhen, Guangdong, China

Tel: +86-755 2523 4088

E-mail: agc@agc-cert.com

Service Hotline:400 089 2118

Test Report

Applicant Name	King Jim Co., Ltd.
Applicant Address	10-18,Higashi-kanda 2-chome Chiyoda-ku,Tokyo,Japan
Manufacturer Name	Travis GT b.v.
Manufacturer Address	Stationsplein 45, 3013 AK Rotterdam, The Netherlands, Rotterdam, Netherlands
Factory Name	SHENZHEN HUNGPHONE TECHNOLOGY CO., LTD
Factory Address	F3-4, Block B6, XuJingChang Industry Park, Fuyong, Bao'an, Shenzhen, China
Product Designation	Portable Translator
Brand Name	World Speak
Model Name	HYP10
EUT Voltage	DC3.8V by battery
Applicable Standard	IEEE Std. 1528:2013 FCC 47 CFR Part 2§2.1093:2013 IEEE C95.1TM:2005
Test Date	July 03,2019 to July 17,2019
Report Template	AGCRT-US-4G/SAR (2018-01-01)

Note: The results of testing in this report apply to the product/system which was tested only.

Eric Zhou

Tested By _____

Eric Zhou(Zhou Yongkang)

July 17,2019

Jack Gui

Checked By _____

Jack Gui (Gui Jiafeng)

July 29,2019

Forrest Lei

Authorized By _____

Forrest Lei(Lei Yonggang)

Authorized Officer

July 29,2019



Attestation of Global Compliance(Shenzhen)Co.,Ltd.

Add: 2/F., Building 2, No.1-4, Chaxi Sanwei Technial Industrial Park, Gushu,
Xixiang, Bao'an District, Shenzhen, Guangdong, China

Tel: +86-755 2523 4088

E-mail: agc@agc-cert.com

Service Hotline:400 089 2118

TABLE OF CONTENTS

1. SUMMARY OF MAXIMUM SAR VALUE	5
2. GENERAL INFORMATION	6
2.1. EUT DESCRIPTION.....	6
3. SAR MEASUREMENT SYSTEM	8
3.1. THE SATIMO SYSTEM USED FOR PERFORMING COMPLIANCE TESTS CONSISTS OF FOLLOWING ITEMS.....	8
3.2. COMOSAR E-FIELD PROBE.....	9
3.3. ROBOT.....	9
3.4. VIDEO POSITIONING SYSTEM.....	10
3.5. DEVICE HOLDER.....	10
3.6. SAM TWIN PHANTOM.....	10
4. SAR MEASUREMENT PROCEDURE	12
4.1. SPECIFIC ABSORPTION RATE (SAR).....	12
4.2. SAR MEASUREMENT PROCEDURE.....	13
4.3. RF EXPOSURE CONDITIONS.....	15
5. TISSUE SIMULATING LIQUID	17
5.1. THE COMPOSITION OF THE TISSUE SIMULATING LIQUID.....	17
5.2. TISSUE DIELECTRIC PARAMETERS FOR HEAD AND BODY PHANTOMS.....	17
5.3. TISSUE CALIBRATION RESULT.....	18
6. SAR SYSTEM CHECK PROCEDURE	20
6.1. SAR SYSTEM CHECK PROCEDURES.....	20
6.2. SAR SYSTEM CHECK.....	21
7. EUT TEST POSITION	23
7.1. BODY WORN POSITION.....	23
8. SAR EXPOSURE LIMITS	24
9. TEST FACILITY	25
10. TEST EQUIPMENT LIST	26
11. MEASUREMENT UNCERTAINTY	27
12. CONDUCTED POWER MEASUREMENT	30
13. TEST RESULTS	56
13.1. SAR TEST RESULTS SUMMARY.....	56
APPENDIX A. SAR SYSTEM CHECK DATA	79
APPENDIX B. SAR MEASUREMENT DATA	95
APPENDIX C. TEST SETUP PHOTOGRAPHS	129
APPENDIX D. CALIBRATION DATA	134



1. SUMMARY OF MAXIMUM SAR VALUE

The maximum results of Specific Absorption Rate (SAR) found during testing for EUT are as follows:

Frequency Band	Highest Reported 1g-SAR(W/Kg)	SAR Test Limit (W/Kg)
	Body-worn	
GSM 850	0.633	1.6
PCS 1900	1.423	
UMTS Band II	1.489	
UMTS Band V	0.477	
LTE Band 2	1.492	
LTE Band 5	0.626	
LTE Band 7	1.392	
LTE Band 12	0.186	
LTE Band 17	0.621	
LTE Band 40	0.179	
LTE Band 41	1.497	
WIFI 2.4G	0.079	
Simultaneous Reported SAR	1.576	
SAR Test Result	PASS	

This device is compliance with Specific Absorption Rate (SAR) for general population/uncontrolled exposure limits (1.6W/Kg) specified in IEEE Std. 1528:2013; FCC 47CFR § 2.1093; IEEE/ANSI C95.1:2005 and the following specific FCC Test Procedures:

- KDB 447498 D01 General RF Exposure Guidance v06
- KDB 648474 D04 Handset SAR v01r03
- KDB 865664 D01 SAR Measurement 100MHz to 6GHz v01r04
- KDB 941225 D01 3G SAR Procedures v03r01
- KDB 941225 D06 Hotspot Mode v02r01
- KDB 248227 D01 802 11 Wi-Fi SAR v02r02
- KDB 941225 D05 SAR for LTE Devices v02r05



Attestation of Global Compliance(Shenzhen)Co.,Ltd.

Add: 2/F., Building 2, No.1-4, Chaxi Sanwei Technial Industrial Park, Gushu,
Xixiang, Bao'an District, Shenzhen, Guangdong, China

Tel: +86-755 2523 4088

E-mail: agc@agc-cert.com

Service Hotline:400 089 2118

2. GENERAL INFORMATION

2.1. EUT Description

General Information	
Product Designation	Portable Translator
Test Model	HYP10
Hardware Version	F01
Software Version	V1.0.0
Device Category	Portable
RF Exposure Environment	Uncontrolled
Antenna Type	Internal
GPRS& EGPRS	
Support Band	<input checked="" type="checkbox"/> GSM 850 <input checked="" type="checkbox"/> PCS 1900 (U.S. Bands) <input checked="" type="checkbox"/> GSM 900 <input checked="" type="checkbox"/> DCS 1800 (Non-U.S. Bands)
GPRS & EGPRS Type	Class B
GPRS & EGPRS Class	Class 12(1Tx+4Rx, 2Tx+3Rx, 3Tx+2Rx, 4Tx+1Rx)
TX Frequency Range	GSM 850 : 820-850MHz; PCS 1900: 1850-1910MHz;
RX Frequency Range	GSM 850 : 869~894MHz; PCS 1900: 1930~1990MHz
Release Version	R99
Type of modulation	GMSK for GPRS; GMSK & 8-PSK for EGPRS
Antenna Gain	GSM850:1.23dBi; PCS1900: 1.31dBi;
Max. Average Power	GSM850: 31.52dBm; PCS1900: 29.44dBm
WCDMA	
Support Band	<input checked="" type="checkbox"/> UMTS FDD Band II <input checked="" type="checkbox"/> UMTS FDD Band V (U.S. Bands) <input checked="" type="checkbox"/> UMTS FDD Band I <input checked="" type="checkbox"/> UMTS FDD Band VIII (Non-U.S. Bands)
HS Type	HSPA(HSUPA/HSDPA)
TX Frequency Range	Band II: 1850-1910MHz; Band V: 820-850MHz
RX Frequency Range	Band II: 1930-1990MHz; Band V: 869-894MHz
Release Version	Rel-6
Type of modulation	HSDPA:QPSK/16QAM; HSUPA:BPSK; WCDMA:QPSK
Antenna Gain	Band II: 1.19dBii; Band V: 1.23dBi
Max. Average Power	Band II: 22.90dBm; Band V: 23.58dBm



EUT Description(Continue)

LTE	
Support Band	<input checked="" type="checkbox"/> FDD Band 2 <input checked="" type="checkbox"/> FDD Band 5 <input checked="" type="checkbox"/> FDD Band 7 <input checked="" type="checkbox"/> FDD Band 12 <input checked="" type="checkbox"/> FDD Band 17 <input checked="" type="checkbox"/> TDD Band 40 <input checked="" type="checkbox"/> TDD Band 41 (U.S. Bands) <input checked="" type="checkbox"/> FDD Band 1 <input checked="" type="checkbox"/> FDD Band 3 <input checked="" type="checkbox"/> FDD Band 8 <input checked="" type="checkbox"/> FDD Band 19 <input checked="" type="checkbox"/> FDD Band 20 <input checked="" type="checkbox"/> TDD Band 28 <input checked="" type="checkbox"/> TDD Band 38 <input checked="" type="checkbox"/> TDD Band 39 (Non-U.S. Bands)
TX Frequency Range	Band 2:1850-1910MHz; Band 5:824-849MHz; Band 7:2500-2570MHz; Band 12:699-716MHz; Band 17: 704-716MHz; Band 40:2300-2400MHz; Band 41:2496-2690MHz
RX Frequency Range	Band 2:1930-1990MHz; Band 5:869-894MHz; Band 7:2620-2690MHz; Band 12: 729-746 MHz; Band 17: 734-746 MHz; Band 40:2300-2400MHz; Band 41:2496-2690MHz
Release Version	Rel-8
Type of modulation	QPSK, 16QAM
Antenna Gain	Band 2: 1.16dBi; Band 5: 1.11dBi; Band 7 : 1.22dBi; Band 12:1.13dBi; Band 17:1.15dBi; Band 40:1.25dBi; Band 41:1.26dBi
Diversity Antenna gain:	Band 2: 1.13dBi; Band 5: 1.09dBi; Band 7 : 1.20dBi;Band 12:1.05dBi; Band 17:1.11dBi; Band 40: 1.23dBi Band 41:1.23dBi
Max. Average Power	Band 2: 24.03dBm; Band 5: 24.47dBm; Band 7: 23.59dBm; Band 12: 24.48dBm; Band 17: 23.60dBm; Band 40: 23.78dBm; Band 41: 23.90dBm
Bluetooth	
Bluetooth Version	<input type="checkbox"/> V2.0 <input type="checkbox"/> V2.1 <input type="checkbox"/> V2.1+EDR <input type="checkbox"/> V3.0 <input type="checkbox"/> V3.0+HS <input type="checkbox"/> V4.0 <input checked="" type="checkbox"/> V4.2
Operation Frequency	2402~2480MHz
Type of modulation	<input checked="" type="checkbox"/> GFSK <input checked="" type="checkbox"/> π/4-DQPSK <input checked="" type="checkbox"/> 8-DPSK
Peak Power	1.704dBm
Antenna Gain	1.28dBi
WIFI	
WIFI Specification	<input type="checkbox"/> 802.11a <input checked="" type="checkbox"/> 802.11b <input checked="" type="checkbox"/> 802.11g <input checked="" type="checkbox"/> 802.11n(20) <input checked="" type="checkbox"/> 802.11n(40)
Operation Frequency	2412~2462MHz
Avg. Burst Power	11b: 14.34dBm, 11g:12.41dBm, 11n(20):11.84dBm, 11n(40):11.96dBm
Antenna Gain	1.26dBi
Accessories	
Battery	Brand name: N/A Model No. : F120001PA Voltage and Capacitance: 3.80 V & 2500mAh
Earphone	Brand name: N/A Model No. : N/A

Note:1.CMU200 can measure the average power and Peak power at the same time
2.The sample used for testing is end product.

Product	Type
	<input checked="" type="checkbox"/> Production unit <input type="checkbox"/> Identical Prototype



Attestation of Global Compliance(Shenzhen)Co.,Ltd.

Add: 2/F., Building 2, No.1-4, Chaxi Sanwei Technial Industrial Park, Gushu, Xixiang, Bao'an District, Shenzhen, Guangdong, China

Tel: +86-755 2523 4088

E-mail: agc@agc-cert.com

Service Hotline:400 089 2118

3. SAR MEASUREMENT SYSTEM

3.1. The SATIMO system used for performing compliance tests consists of following items

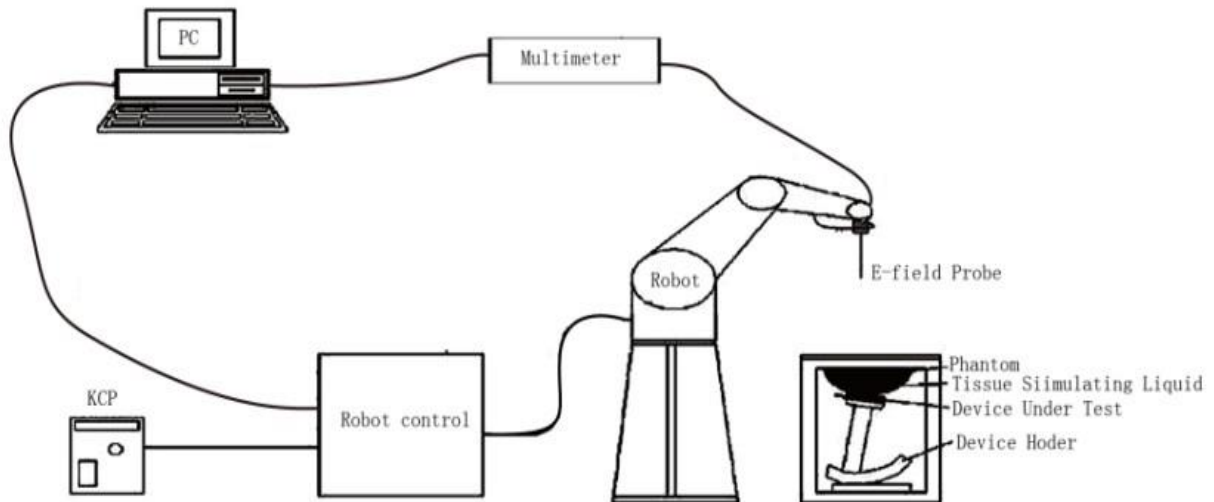

The COMOSAR system for performing compliance tests consists of the following items:

- The PC. It controls most of the bench devices and stores measurement data. A computer running WinXP and the Opensar software.
- The E-Field probe. The probe is a 3-axis system made of 3 distinct dipoles. Each dipole returns a voltage in function of the ambient electric field.
- The Keithley multimeter measures each probe dipole voltages.
- The SAM phantom simulates a human head. The measurement of the electric field is made inside the phantom.
- The liquids simulate the dielectric properties of the human head tissues.
- The network emulator controls the mobile phone under test.
- The validation dipoles are used to measure a reference SAR. They are used to periodically check the bench to make sure that there is no drift of the system characteristics over time.
- The phantom, the device holder and other accessories according to the targeted measurement.

3.2. COMOSAR E-Field Probe

The SAR measurement is conducted with the dosimetric probe manufactured by SATIMO. The probe is specially designed and calibrated for use in liquid with high permittivity. The dosimetric probe has special calibration in liquid at different frequency. SATIMO conducts the probe calibration in compliance with international and national standards (e.g. IEEE 1528 and relevant KDB files.) The calibration data are in Appendix D.

Isotropic E-Field Probe Specification

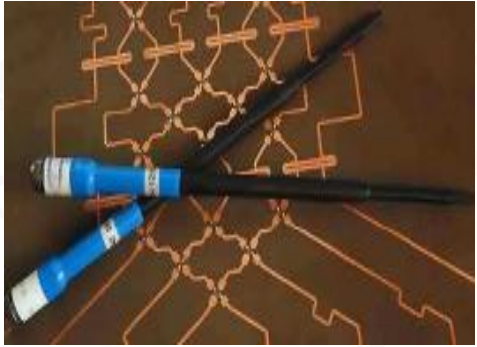
Model	SSE5	
Manufacture	MVG	
Identification No.	SN 22/12 EP159	
Frequency	0.45GHz-3GHz Linearity:±0.11dB(0.45GHz-3GHz)	
Dynamic Range	0.01W/Kg-100W/Kg Linearity:±0.11dB	
Dimensions	Overall length:330mm Length of individual dipoles:4.5mm Maximum external diameter:8mm Probe Tip external diameter:5mm Distance between dipoles/ probe extremity:2.7mm	
Application	High precision dosimetric measurements in any exposure scenario (e.g., very strong gradient fields). Only probe which enables compliance testing for frequencies up to 3 GHz with precision of better 30%.	

3.3. Robot

The COMOSAR system uses the KUKA robot from SATIMO SA (France).For the 6-axis controller COMOSAR system, the KUKA robot controller version from SATIMO is used.

The XL robot series have many features that are important for our application:

- High precision (repeatability 0.02 mm)
- High reliability (industrial design)
- Jerk-free straight movements
- Low ELF interference (the closed metallic construction shields against motor control fields)
- 6-axis controller



3.4. Video Positioning System

The video positioning system is used in OpenSAR to check the probe. Which is composed of a camera, LED, mirror and mechanical parts. The camera is piloted by the main computer with firewire link. During the process, the actual position of the probe tip with respect to the robot arm is measured, as well as the probe length and the horizontal probe offset. The software then corrects all movements, such that the robot coordinates are valid for the probe tip. The repeatability of this process is better than 0.1 mm. If a position has been taught with an aligned probe, the same position will be reached with another aligned probe within 0.1 mm, even if the other probe has different dimensions. During probe rotations, the probe tip will keep its actual position.

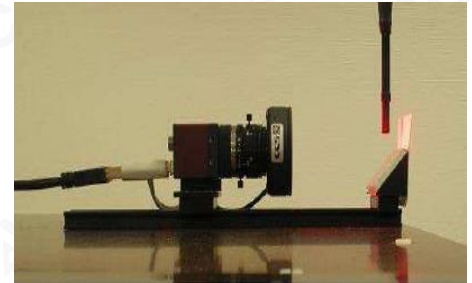

3.5. Device Holder

The COMOSAR device holder is designed to cope with different positions given in the standard. It has two scales for the device rotation (with respect to the body axis) and the device inclination (with respect to the line between the ear reference points). The rotation center for both scales is the ear reference point (EPR). Thus the device needs no repositioning when changing the angles. The COMOSAR device holder has been made out of low-loss POM material having the following dielectric parameters: relative permittivity $\epsilon_r = 3$ and loss tangent $\delta = 0.02$. The amount of dielectric material has been reduced in the closest vicinity of the device, since measurements have suggested that the influence of the clamp on the test results could thus be lowered.

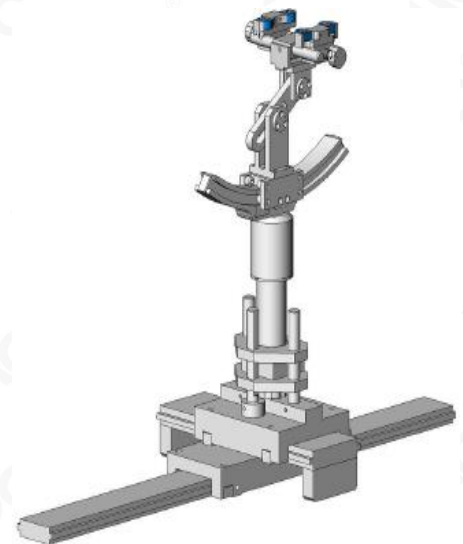

3.6. SAM Twin Phantom



The SAM twin phantom is a fiberglass shell phantom with 2mm shell thickness (except the ear region where shell thickness increases to 6mm). It has three measurement areas:

- Left head
- Right head
- Flat phantom



The bottom plate contains three pair of bolts for locking the device holder. The device holder positions are adjusted to the standard measurement positions in the three sections. A white cover is provided to tap the phantom during off-periods to prevent water evaporation and changes in the liquid parameters. On the phantom top, three reference markers are provided to identify the phantom position with respect to the robot.

4. SAR MEASUREMENT PROCEDURE

4.1. Specific Absorption Rate (SAR)

SAR is related to the rate at which energy is absorbed per unit mass in object exposed to a radio field. The SAR distribution in a biological body is complicated and is usually carried out by experimental techniques or numerical modeling. The standard recommends limits for two tiers of groups, occupational/controlled and occupational/uncontrolled, based on a person's awareness and ability to exercise control over his or her exposure. In general, occupational/controlled exposure limits are higher than the limits for general population/uncontrolled.

The SAR definition is the time derivative (rate) of the incremental energy (dW) absorbed by (dissipated in) an incremental mass (dm) contained in a volume element(dv) of given mass density (ρ). The equation description is as below:

$$SAR = \frac{d}{dt} \left(\frac{dW}{dm} \right) = \frac{d}{dt} \left(\frac{dW}{\rho dV} \right)$$

SAR is expressed in units of Watts per kilogram (W/Kg)

SAR can be obtained using either of the following equations:

$$SAR = \frac{\sigma E^2}{\rho}$$

$$SAR = c_h \left. \frac{dT}{dt} \right|_{t=0}$$

Where

SAR	is the specific absorption rate in watts per kilogram;
E	is the r.m.s. value of the electric field strength in the tissue in volts per meter;
σ	is the conductivity of the tissue in siemens per metre;
ρ	is the density of the tissue in kilograms per cubic metre;
c _h	is the heat capacity of the tissue in joules per kilogram and Kelvin;
$\left. \frac{dT}{dt} \right _{t=0}$	is the initial time derivative of temperature in the tissue in kelvins per second



4.2. SAR Measurement Procedure

Step 1: Power Reference Measurement

The Power Reference Measurement and Power Drift Measurement are for monitoring the power drift of the device under test in the batch process. The minimum distance of probe sensors to surface is 2.7mm This distance cannot be smaller than the distance of sensor calibration points to probe tip as defined in the probe properties,

Step 2: Area Scan

The Area Scan is used as a fast scan in two dimensions to find the area of high field values, before doing a fine measurement around the hot spot. The sophisticated interpolation routines implemented in SATIMO software can find the maximum locations even in relatively coarse grids. When an Area Scan has measured all reachable points, it computes the field maximal found in the scanned area, within a range of the global maximum. The range (in db) is specified in the standards for compliance testing. For example, a 2db range is required in IEEE Standard 1528 and IEC62209 standards, whereby 3db is a requirement when compliance is assessed in accordance with the ARIB standard (Japan) If one Zoom Scan follows the Area Scan, then only the absolute maximum will be taken as reference. For cases where multiple maximum are detected, the number of Zoom Scan has to be increased accordingly.

Area Scan Parameters extracted from KDB 865664 D01 SAR Measurement 100MHz to 6GHz

	≤ 3 GHz	> 3 GHz
Maximum distance from closest measurement point (geometric center of probe sensors) to phantom surface	5 ± 1 mm	$\frac{1}{2} \cdot \delta \cdot \ln(2) \pm 0.5$ mm
Maximum probe angle from probe axis to phantom surface normal at the measurement location	30° ± 1°	20° ± 1°
Maximum area scan spatial resolution: Δx_{Area} , Δy_{Area}	≤ 2 GHz: ≤ 15 mm 2 – 3 GHz: ≤ 12 mm	3 – 4 GHz: ≤ 12 mm 4 – 6 GHz: ≤ 10 mm
	When the x or y dimension of the test device, in the measurement plane orientation, is smaller than the above, the measurement resolution must be ≤ the corresponding x or y dimension of the test device with at least one measurement point on the test device.	

Step 3: Zoom Scan

Zoom Scan are used to assess the peak spatial SAR value within a cubic average volume containing 1g and 10g of simulated tissue. The Zoom Scan measures points(refer to table below) within a cube whose base faces are centered on the maxima found in a preceding area scan job within the same procedure. When the measurement is done, the Zoom Scan evaluates the averaged SAR for 1g and 10g and displays these values next to the job's label.



Zoom Scan Parameters extracted from KDB865664 d01 SAR Measurement 100MHz to 6GHz

Maximum zoom scan spatial resolution: Δx_{Zoom} , Δy_{Zoom}		≤ 2 GHz: ≤ 8 mm 2 – 3 GHz: ≤ 5 mm*	3 – 4 GHz: ≤ 5 mm* 4 – 6 GHz: ≤ 4 mm*
Maximum zoom scan spatial resolution, normal to phantom surface	uniform grid: $\Delta z_{Zoom}(n)$	≤ 5 mm	3 – 4 GHz: ≤ 4 mm 4 – 5 GHz: ≤ 3 mm 5 – 6 GHz: ≤ 2 mm
	graded grid	$\Delta z_{Zoom}(1)$: between 1 st two points closest to phantom surface	≤ 4 mm
		$\Delta z_{Zoom}(n>1)$: between subsequent points	$\leq 1.5 \cdot \Delta z_{Zoom}(n-1)$
Minimum zoom scan volume	x, y, z	≥ 30 mm	3 – 4 GHz: ≥ 28 mm 4 – 5 GHz: ≥ 25 mm 5 – 6 GHz: ≥ 22 mm
<p>Note: δ is the penetration depth of a plane-wave at normal incidence to the tissue medium; see draft standard IEEE P1528-2011 for details.</p> <p>* When zoom scan is required and the <i>reported</i> SAR from the <i>area scan based 1-g SAR estimation</i> procedures of KDB 447498 is ≤ 1.4 W/kg, ≤ 8 mm, ≤ 7 mm and ≤ 5 mm zoom scan resolution may be applied, respectively, for 2 GHz to 3 GHz, 3 GHz to 4 GHz and 4 GHz to 6 GHz.</p>			

Step 4: Power Drift Measurement

The Power Drift Measurement measures the field at the same location as the most recent power reference measurement within the same procedure, and with the same settings. The Power Drift Measurement gives the field difference in dB from the reading conducted within the same settings. This allows a user to monitor the power drift of the device under test within a batch process. The measurement procedure is the same as Step 1.



4.3. RF Exposure Conditions

Test Configuration and setting:

The EUT is a model of GSM Portable Mobile Station (MS). It supports GPRS/EGPRS, WCDMA/HSPA, LTE, BT, WIFI, and support hot spot mode.

For WWAN SAR testing, the device was controlled by using a base station emulator. Communication between the device and the emulator were established by air link. The distance between the EUT and the antenna is larger than 50cm, and the output power radiated from the emulator antenna is at least 30db smaller than the output power of EUT.

For WLAN testing, the EUT is configured with the WLAN continuous TX tool through engineering command.

Antenna Location: (the back view)

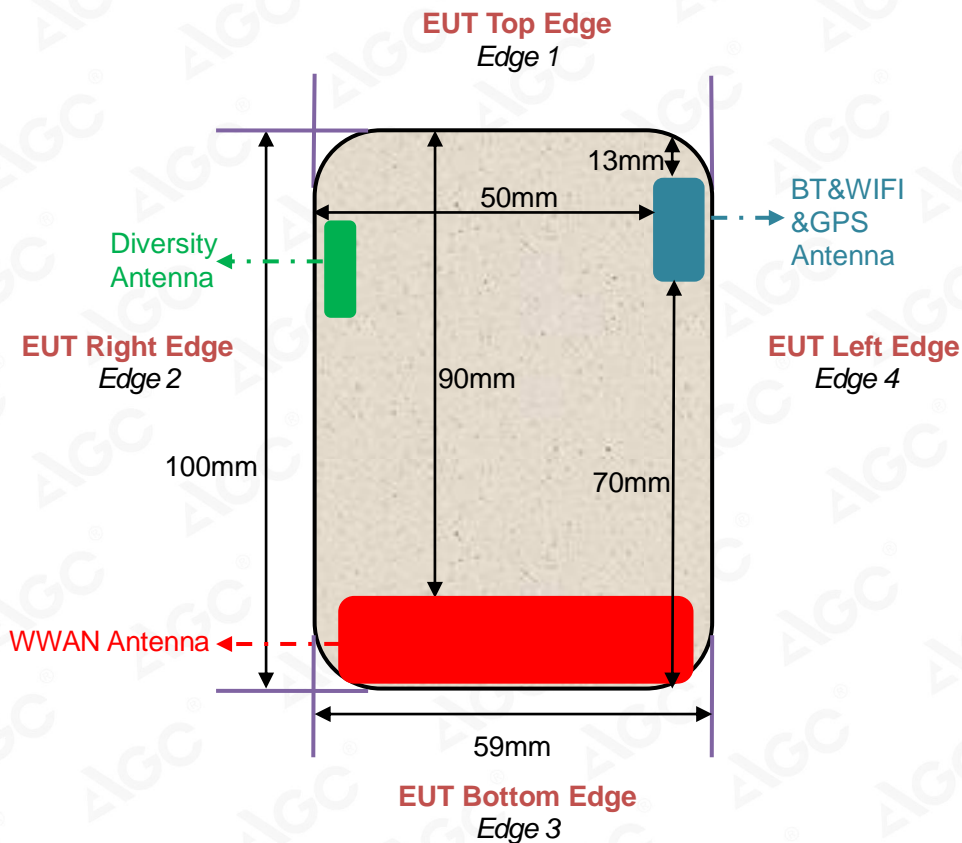

For WWAN mode:

Test Configurations	Antenna to edges/surface	SAR required	Note
Body			
Back	<25mm	Yes	--
Front	<25mm	Yes	--
Hotspot			
Back	<25mm	Yes	--
Front	<25mm	Yes	--
Edge 1 (Top)	90mm	No	SAR is not required for the distance between the antenna and the edge is >25mm as per KDB 941225 D06 Hotspot SAR
Edge 2 (Right)	2mm	Yes	--
Edge 3 (Bottom)	3mm	Yes	--
Edge 4 (Left)	2mm	Yes	--

For WLAN mode:

Test Configurations	Antenna to edges/surface	SAR required	Note
Body			
Back	<25mm	Yes	--
Front	<25mm	Yes	--
Hotspot			
Back	<25mm	Yes	--
Front	<25mm	Yes	--
Edge 1 (Top)	13mm	Yes	--
Edge 2 (Right)	50mm	No	SAR is not required for the distance between the antenna and the edge is >25mm as per KDB 941225 D06 Hotspot SAR
Edge 3 (Bottom)	70mm	No	SAR is not required for the distance between the antenna and the edge is >25mm as per KDB 941225 D06 Hotspot SAR
Edge 4 (Left)	2mm	Yes	--



Attestation of Global Compliance(Shenzhen)Co.,Ltd.

Add: 2/F., Building 2, No.1-4, Chaxi Sanwei Technial Industrial Park, Gushu, Xixiang, Bao'an District, Shenzhen, Guangdong, China

Tel: +86-755 2523 4088 E-mail: agc@agc-cert.com Service Hotline:400 089 2118

5. TISSUE SIMULATING LIQUID

For SAR measurement of the field distribution inside the phantom, the phantom must be filled with homogeneous tissue simulating liquid to a depth of at least 15cm. For head SAR testing the liquid height from the ear reference point (ERP) of the phantom to the liquid top surface is larger than 15cm For body SAR testing, the liquid height from the center of the flat phantom to the liquid top surface is larger than 15cm. The nominal dielectric values of the tissue simulating liquids in the phantom and the tolerance of 5% are listed in 5.2

5.1. The composition of the tissue simulating liquid

Ingredient (% Weight) Frequency (MHz)	Water	Nacl	Polysorbate 20	DGBE	1,2 Propanediol	Triton X-100
750 Body	55	1	0.0	0.0	44	0.0
835 Body	54.00	1	0.0	15	0.0	30
1900 Body	70	1	0.0	9	0.0	20
2300 Body	70	1	0.0	9	0.0	20
2450 Body	70	1	0.0	9	0.0	20
2600 Body	70	1	0	9	0	20

5.2. Tissue Dielectric Parameters for Head and Body Phantoms

The head tissue dielectric parameters recommended by the IEEE 1528 have been incorporated in the following table. These head parameters are derived from planar layer models simulating the highest expected SAR for the dielectric properties and tissue thickness variations in a human head. Other head and body tissue parameters that have not been specified in IEEE 1528 are derived from the tissue dielectric parameters computed from the 4-Cole-Cole equations described in Reference [12] and extrapolated according to the head parameters specified in IEEE 1528.

Target Frequency (MHz)	head		body	
	ϵ_r	σ (S/m)	ϵ_r	σ (S/m)
300	45.3	0.87	58.2	0.92
450	43.5	0.87	56.7	0.94
750	41.9	0.89	55.5	0.96
835	41.5	0.90	55.2	0.97
900	41.5	0.97	55.0	1.05
915	41.5	1.01	55.0	1.06
1450	40.5	1.20	54.0	1.30
1610	40.3	1.29	53.8	1.40
1750	40.1	1.37	53.4	1.49
1800 – 2000	40.0	1.40	53.3	1.52
2300	39.5	1.67	52.9	1.81
2450	39.2	1.80	52.7	1.95
2600	39.0	1.96	52.5	2.16
3000	38.5	2.40	52.0	2.73

(ϵ_r = relative permittivity, σ = conductivity and $\rho = 1000$ kg/m³)



Attestation of Global Compliance(Shenzhen)Co.,Ltd.

Add: 2/F., Building 2, No.1-4, Chaxi Sanwei Technial Industrial Park, Gushu,
Xixiang, Bao'an District, Shenzhen, Guangdong, China

Tel: +86-755 2523 4088

E-mail: agc@agc-cert.com

Service Hotline:400 089 2118

5.3. Tissue Calibration Result

The dielectric parameters of the liquids were verified prior to the SAR evaluation using SATIMO Dielectric Probe Kit and R&S Network Analyzer ZVL6.

Tissue Stimulant Measurement for 750MHz					
	Fr. (MHz)	Dielectric Parameters ($\pm 5\%$)		Tissue Temp [oC]	Test time
		ϵ_r 55.5(52.725-58.275)	δ [s/m]0.96(0.912-1.008)		
Body	704	57.71	0.92	20.7	July 16,2019
	709	57.35	0.93		
	707.5	56.38	0.93		
	710	56.13	0.94		
	711	55.72	0.95		
	750	55.36	0.96		

Tissue Stimulant Measurement for 835MHz					
	Fr. (MHz)	Dielectric Parameters ($\pm 5\%$)		Tissue Temp [oC]	Test time
		ϵ_r 55.20(52.44-57.96)	δ [s/m]0.97(0.9215-1.0185)		
Body	824.2	55.69	0.94	21.6	July 17,2019
	826.4	55.17	0.95		
	835	54.56	0.96		
	836.6	54.22	0.97		
	846.6	53.71	0.97		
	848.8	53.36	0.99		

Tissue Stimulant Measurement for 835MHz					
	Fr. (MHz)	Dielectric Parameters ($\pm 5\%$)		Tissue Temp [oC]	Test time
		ϵ_r 55.20(52.44-57.96)	δ [s/m]0.97(0.9215-1.0185)		
Body	829	55.10	0.95	20.6	July 03,2019
	835	54.62	0.96		
	836.5	54.06	0.97		
	844	53.43	0.99		

Tissue Stimulant Measurement for 1900MHz					
	Fr. (MHz)	Dielectric Parameters ($\pm 5\%$)		Tissue Temp [oC]	Test time
		ϵ_r 53.30(50.635-55.965)	δ [s/m]1.52(1.444-1.596)		
Body	1850.2	54.62	1.46	21.5	July 17,2019
	1852.4	54.10	1.47		
	1880	53.17	1.50		
	1900	52.64	1.51		
	1907.6	52.31	1.53		
	1909.8	51.86	1.54		



Tissue Stimulant Measurement for 1900MHz					
Body	Fr. (MHz)	Dielectric Parameters ($\pm 5\%$)		Tissue Temp [oC]	Test time
		$\epsilon_r 53.30(50.635-55.965)$	$\delta[s/m] 1.52(1.444-1.596)$		
	1860	53.91	1.46	20.6	July 03,2019
	1880	53.27	1.47		
	1900	52.64	1.48		

Tissue Stimulant Measurement for 2300MHz					
Body	Fr. (MHz)	Dielectric Parameters ($\pm 5\%$)		Tissue Temp [oC]	Test time
		$\epsilon_r 52.9(50.26-55.55)$	$\delta[s/m] 1.81(1.72-1.90)$		
	2300	52.36	1.79	21.9	July 13,2019
	2310	51.95	1.80		
	2350	51.62	1.82		
	2390	50.82	1.85		

Tissue Stimulant Measurement for 2450MHz					
Body	Fr. (MHz)	Dielectric Parameters ($\pm 5\%$)		Tissue Temp [oC]	Test time
		$\epsilon_r 52.7(50.065-55.335)$	$\delta[s/m] 1.95(1.8525-2.0475)$		
	2412	54.13	1.89	20.3	July 09,2019
	2437	53.71	1.91		
	2450	52.64	1.92		
	2462	51.37	1.95		

Tissue Stimulant Measurement for 2600MHz					
Body	Fr. (MHz)	Dielectric Parameters ($\pm 5\%$)		Tissue Temp [oC]	Test time
		$\epsilon_r 52.5(49.875-55.125)$	$\delta[s/m] 2.16(2.052-2.268)$		
	2506	54.52	2.08	20.6	July 16,2019
	2510	54.23	2.10		
	2535	53.57	2.12		
	2560	52.79	2.14		
	2593	52.67	2.15		
	2600	52.00	2.16		
	2680	51.43	2.18		



Attestation of Global Compliance(Shenzhen)Co.,Ltd.

Add: 2/F., Building 2, No.1-4, Chaxi Sanwei Technial Industrial Park, Gushu, Xixiang, Bao'an District, Shenzhen, Guangdong, China

Tel: +86-755 2523 4088

E-mail: agc@agc-cert.com

Service Hotline:400 089 2118

6. SAR SYSTEM CHECK PROCEDURE

6.1. SAR System Check Procedures

SAR system check is required to confirm measurement accuracy, according to the tissue dielectric media, probe calibration points and other system operating parameters required for measuring the SAR of a test device. The system verification must be performed for each frequency band and within the valid range of each probe calibration point required for testing the device. The same SAR probe(s) and tissue-equivalent media combinations used with each specific SAR system for system verification must be used for device testing. When multiple probe calibration points are required to cover substantially large transmission bands, independent system verifications are required for each probe calibration point. A system verification must be performed before each series of SAR measurements using the same probe calibration point and tissue-equivalent medium. Additional system verification should be considered according to the conditions of the tissue-equivalent medium and measured tissue dielectric parameters, typically every three to four days when the liquid parameters are remeasured or sooner when marginal liquid parameters are used at the beginning of a series of measurements.

Each SATIMO system is equipped with one or more system check kits. These units, together with the predefined measurement procedures within the SATIMO software, enable the user to conduct the system check and system validation. System kit includes a dipole, and dipole device holder.

The system check verifies that the system operates within its specifications. It's performed daily or before every SAR measurement. The system check uses normal SAR measurement in the flat section of the phantom with a matched dipole at a specified distance. The system check setup is shown as below.

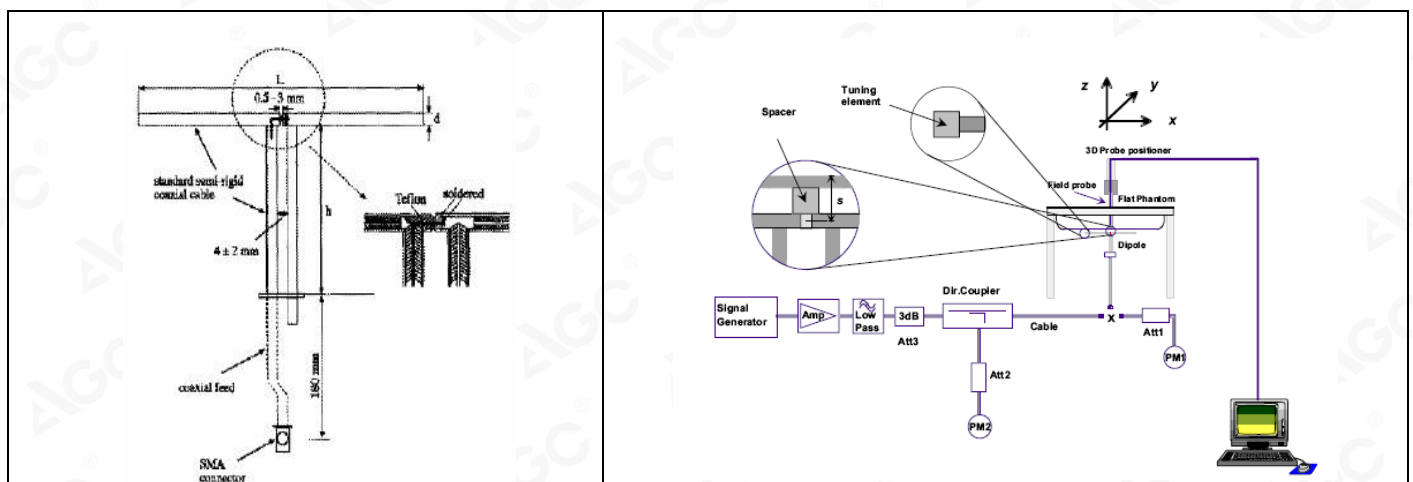

6.2. SAR System Check

6.2.1. Dipoles

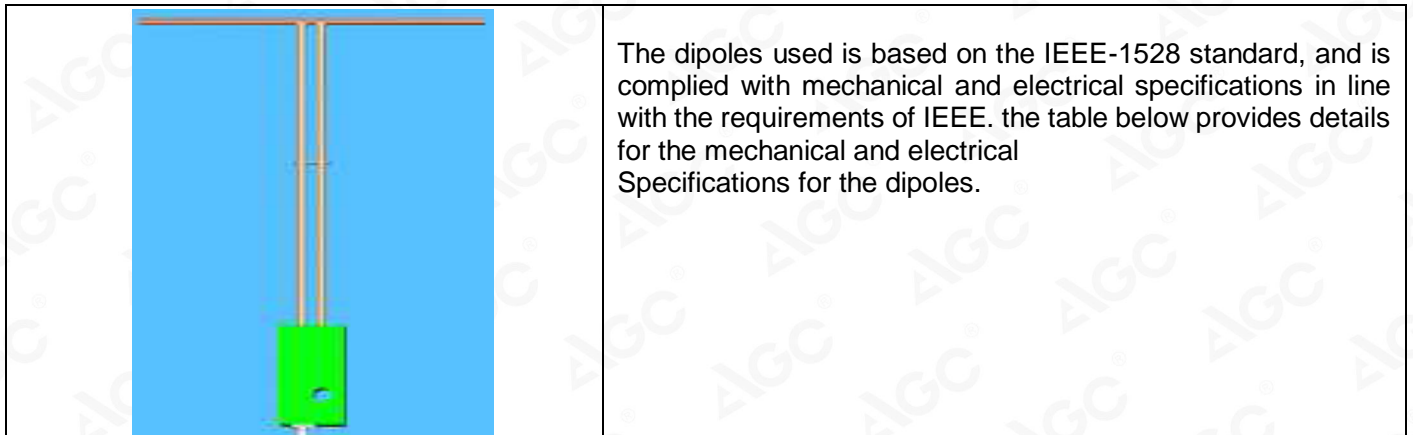

Frequency	L (mm)	h (mm)	d (mm)
750MHz	176	100	6.35
835MHz	161.0	89.8	3.6
1800MHz	71.6	41.7	3.6
1900MHz	68	39.5	3.6
2300MHz	55.5	32.6	3.6
2450MHz	51.5	30.4	3.6
2600MHz	48.5	28.8	3.6



Attestation of Global Compliance(Shenzhen)Co.,Ltd.

Add: 2/F., Building 2, No.1-4, Chaxi Sanwei Technial Industrial Park, Gushu,
Xixiang, Bao'an District, Shenzhen, Guangdong, China

Tel: +86-755 2523 4088

E-mail: agc@agc-cert.com

Service Hotline:400 089 2118

6.2.2. System Check Result

System Performance Check at 750MHz & 835MHz & 1800MHz & 1900MHz & 2300MHz & 2450MHz & 2600MHz for Body								
Validation Kit: SN47/14 DIP 0G750-340& SN29/15 DIP 0G835-383& SN46/11 DIP 1G800-186& SN 46/11 DIP 1G900-187& SN 47/14 DIP 2G300-341& SN46/11 DIP 2G450-189& SN 47/14 DIP 2G600-342								
Frequency [MHz]	Target Value(W/Kg)		Reference Result ($\pm 10\%$)		Tested Value(W/Kg)		Tissue Temp. [°C]	Test time
	1g	10g	1g	10g	1g	10g		
750	8.45	5.67	7.605-9.295	5.103-6.237	9.25	5.97	20.7	July 16,2019
835	9.95	6.50	8.955-10.945	5.85-7.15	9.70	6.49	21.6	July 17,2019
835	9.95	6.50	8.955-10.945	5.85-7.15	9.55	6.32	20.6	July 03,2019
1900	40.82	20.99	36.738-44.902	18.891-23.089	40.30	20.32	21.5	July 17,2019
1900	40.82	20.99	36.738-44.902	18.891-23.089	39.33	20.80	20.6	July 03,2019
2300	50.74	23.23	48.203-53.277	22.069-24.392	49.95	23.17	21.9	July 13,2019
2450	54.45	24.16	49.005-59.895	21.744-26.576	54.62	23.77	20.3	July 09,2019
2600	56.51	24.25	50.859-62.161	21.825-26.675	56.90	24.92	20.6	July 16,2019

Note:

(1) We use a CW signal of 18dBm for system check, and then all SAR value are normalized to 1W forward power. The result must be within $\pm 10\%$ of target value.



Attestation of Global Compliance(Shenzhen)Co.,Ltd.

Add: 2/F., Building 2, No.1-4, Chaxi Sanwei Technical Industrial Park, Gushu, Xixiang, Bao'an District, Shenzhen, Guangdong, China

Tel: +86-755 2523 4088

E-mail: agc@agc-cert.com

Service Hotline:400 089 2118

7. EUT TEST POSITION

This EUT was tested in **Body back, Body front and 4 edges**.

7.1. Body Worn Position

- (1) To position the EUT parallel to the phantom surface.
- (2) To adjust the EUT parallel to the flat phantom.
- (3) To adjust the distance between the EUT surface and the flat phantom to **5mm**.

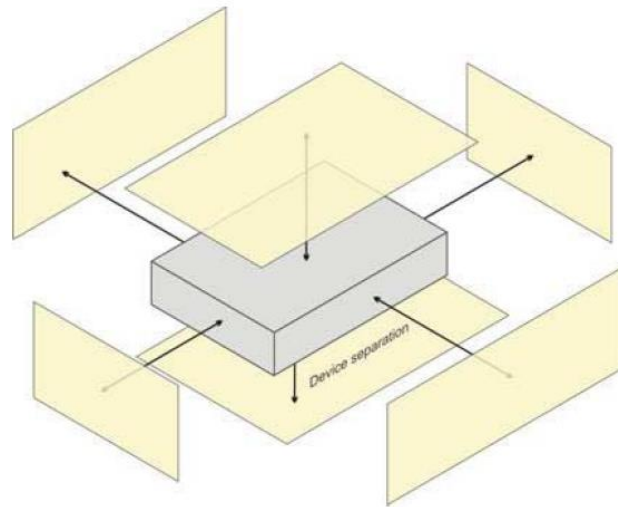

8. SAR EXPOSURE LIMITS

Limits for General Population/Uncontrolled Exposure (W/kg)

Type Exposure	Uncontrolled Environment Limit (W/kg)
Spatial Peak SAR (1g cube tissue for brain or body)	1.60
Spatial Average SAR (Whole body)	0.08
Spatial Peak SAR (Limbs)	4.0



Attestation of Global Compliance(Shenzhen)Co.,Ltd.

Add: 2/F., Building 2, No.1-4, Chaxi Sanwei Technial Industrial Park, Gushu,
Xixiang, Bao'an District, Shenzhen, Guangdong, China

Tel: +86-755 2523 4088

E-mail: agc@agc-cert.com

Service Hotline:400 089 2118

9. TEST FACILITY

Test Site	Attestation of Global Compliance (Shenzhen) Co., Ltd
Location	1-2/F, Building 19, Junfeng Industrial Park, Chongqing Road, Heping Community, Fuhai Street, Bao'an District, Shenzhen, Guangdong, China
Designation Number	CN1259
FCC Test Firm Registration Number	975832
A2LA Cert. No.	5054.02
Description	Attestation of Global Compliance(Shenzhen) Co., Ltd is accredited by A2LA



Attestation of Global Compliance(Shenzhen)Co.,Ltd.

Add: 2/F., Building 2, No.1-4, Chaxi Sanwei Technial Industrial Park, Gushu, Xixiang, Bao'an District, Shenzhen, Guangdong, China

Tel: +86-755 2523 4088

E-mail: agc@agc-cert.com

Service Hotline:400 089 2118

10. TEST EQUIPMENT LIST

Equipment description	Manufacturer/ Model	Identification No.	Current calibration date	Next calibration date
SAR Probe	MVG	SN 22/12 EP159	Aug. 08,2018	Aug. 07,2019
Phantom	SATIMO	SN_4511_SAM90	Validated. No cal required.	Validated. No cal required.
Liquid	SATIMO	-	Validated. No cal required.	Validated. No cal required.
Comm Tester	Agilent-8960	GB46310822	Feb. 27,2019	Feb. 26,2020
Comm Tester	R&S- CMW500	S/N120909	Jul. 02,2019	Jul. 01,2020
Multimeter	Keithley 2000	4114939	Sep. 20,2018	Sep. 19,2019
Dipole	SATIMO SID750	SN47/14 DIP 0G750-340	Apr. 26,2019	Apr. 25,2022
Dipole	SATIMO SID835	SN29/15 DIP 0G835-383	Apr. 26,2019	Apr. 25,2022
Dipole	SATIMO SID1900	SN 46/11 DIP 1G900-187	Apr. 26,2019	Apr. 25,2022
Dipole	SATIMO SID2300	SN 47/14 DIP 2G300-341	Apr. 26,2019	Apr. 25,2022
Dipole	SATIMO SID2450	SN46/11 DIP 2G450-189	Apr. 26,2019	Apr. 25,2022
Dipole	SATIMO SID2600	SN 47/14 DIP 2G600-342	Apr. 26,2019	Apr. 25,2022
Signal Generator	Agilent-E4438C	US41461365	Nov. 01,2018	Oct. 31,2019
Vector Analyzer	Agilent / E4440A	US41421290	Feb. 27,2019	Feb. 26,2020
Network Analyzer	Rhode & Schwarz ZVL6	SN101443	Nov. 01,2018	Oct. 31,2019
Attenuator	Warison /WATT-6SR1211	S/N:WRJ34AYM2F1	June 11,2019	June 10, 2020
Attenuator	Mini-circuits / VAT-10+	31405	June 11,2019	June 10, 2020
Amplifier	EM30180	SN060552	Feb. 27,2019	Feb. 26,2020
Directional Couple	Werlatone/ C5571-10	SN99463	June 12,2019	June 11,2020
Directional Couple	Werlatone/ C6026-10	SN99482	June 12,2019	June 11,2020
Power Sensor	NRP-Z21	1137.6000.02	Sep. 20,2018	Sep. 19,2019
Power Sensor	NRP-Z23	US38261498	Feb. 19,2019	Feb. 18,2020
Power Viewer	R&S	V2.3.1.0	N/A	N/A

Note: Per KDB 865664 Dipole SAR Validation, AGC Lab has adopted 3 years calibration intervals. On annual basis, every measurement dipole has been evaluated and is in compliance with the following criteria:

1. There is no physical damage on the dipole;
2. System validation with specific dipole is within 10% of calibrated value;
3. Return-loss is within 20% of calibrated measurement;
4. Impedance is within 5Ω of calibrated measurement.



Attestation of Global Compliance(Shenzhen)Co.,Ltd.

Add: 2/F., Building 2, No.1-4, Chaxi Sanwei Technial Industrial Park, Gushu,
Xixiang, Bao'an District, Shenzhen, Guangdong, China

Tel: +86-755 2523 4088 E-mail: agc@agc-cert.com Service Hotline:400 089 2118

11. MEASUREMENT UNCERTAINTY

Measurement uncertainty for Dipole averaged over 1 gram / 10 gram.									
a	b	c	d	^e f(d,k)	f	g	^h cx _f /e	ⁱ cx _g /e	k
Uncertainty Component	Sec.	Tol (± %)	Prob. Dist.	Div.	Ci (1g)	Ci (10g)	1g U _i (±%)	10g U _i (±%)	v _i
Measurement System									
Probe calibration	E.2.1	5.831	N	1	1	1	5.83	5.83	∞
Axial Isotropy	E.2.2	0.695	R	√3	√0.5	√0.5	0.28	0.28	∞
Hemispherical Isotropy	E.2.2	1.045	R	√3	√0.5	√0.5	0.43	0.43	∞
Boundary effect	E.2.3	1.0	R	√3	1	1	0.58	0.58	∞
Linearity	E.2.4	0.685	R	√3	1	1	0.40	0.40	∞
System detection limits	E.2.4	1.0	R	√3	1	1	0.58	0.58	∞
Modulation response	E.2.5	3.0	R	√3	1	1	1.73	1.73	∞
Readout Electronics	E.2.6	0.021	N	1	1	1	0.021	0.021	∞
Response Time	E.2.7	0	R	√3	1	1	0	0	∞
Integration Time	E.2.8	1.4	R	√3	1	1	0.81	0.81	∞
RF ambient conditions-Noise	E.6.1	3.0	R	√3	1	1	1.73	1.73	∞
RF ambient conditions-reflections	E.6.1	3.0	R	√3	1	1	1.73	1.73	∞
Probe positioner mechanical tolerance	E.6.2	1.4	R	√3	1	1	0.81	0.81	∞
Probe positioning with respect to phantom shell	E.6.3	1.4	R	√3	1	1	0.81	0.81	∞
Extrapolation, interpolation, and integrations algorithms for max. SAR evaluation	E.5	2.3	R	√3	1	1	1.33	1.33	∞
Test sample Related									
Test sample positioning	E.4.2	2.6	N	1	1	1	2.6	2.6	∞
Device holder uncertainty	E.4.1	3	N	1	1	1	3	3	∞
Output power variation—SAR drift measurement	E.2.9	5	R	√3	1	1	2.89	2.89	∞
SAR scaling	E.6.5	5	R	√3	1	1	2.89	2.89	∞
Phantom and tissue parameters									
Phantom shell uncertainty—shape, thickness, and permittivity	E.3.1	4	R	√3	1	1	2.31	2.31	∞
Uncertainty in SAR correction for deviations in permittivity and conductivity	E.3.2	1.9	N	1	1	0.84	1.90	1.60	∞
Liquid conductivity measurement	E.3.3	4	N	1	0.78	0.71	3.12	2.84	M
Liquid permittivity measurement	E.3.3	5	N	1	0.23	0.26	1.15	1.30	M
Liquid conductivity—temperature uncertainty	E.3.4	2.5	R	√3	0.78	0.71	1.13	1.02	∞
Liquid permittivity—temperature uncertainty	E.3.4	2.5	R	√3	0.23	0.26	0.33	0.38	∞
Combined Standard Uncertainty			RSS				9.79	9.59	
Expanded Uncertainty (95% Confidence interval)			K=2				19.58	19.18	



Attestation of Global Compliance(Shenzhen)Co.,Ltd.

Add: 2/F., Building 2, No.1-4, Chaxi Sanwei Technial Industrial Park, Gushu, Xixiang, Bao'an District, Shenzhen, Guangdong, China

Tel: +86-755 2523 4088

E-mail: agc@agc-cert.com

Service Hotline:400 089 2118

System check uncertainty for Dipole averaged over 1 gram / 10 gram.									
a	b	c	d	^e f(d,k)	f	g	^h cxf/e	ⁱ cxg/e	k
Uncertainty Component	Sec.	Tol (± %)	Prob. Dist.	Div.	Ci (1g)	Ci (10g)	1g Ui (±%)	10g Ui (±%)	vi
Measurement System									
Probe calibration drift	E.2.1.3	0.5	N	1	1	1	0.50	0.50	∞
Axial Isotropy	E.2.2	0.695	R	$\sqrt{3}$	0	0	0.00	0.00	∞
Hemispherical Isotropy	E.2.2	1.045	R	$\sqrt{3}$	0	0	0.00	0.00	∞
Boundary effect	E.2.3	1.0	R	$\sqrt{3}$	0	0	0.00	0.00	∞
Linearity	E.2.4	0.685	R	$\sqrt{3}$	0	0	0.00	0.00	∞
System detection limits	E.2.4	1.0	R	$\sqrt{3}$	0	0	0.00	0.00	∞
Modulation response	E.2.5	3.0	R	$\sqrt{3}$	0	0	0.00	0.00	∞
Readout Electronics	E.2.6	0.021	N	1	0	0	0.00	0.00	∞
Response Time	E.2.7	0	R	$\sqrt{3}$	0	0	0.00	0.00	∞
Integration Time	E.2.8	1.4	R	$\sqrt{3}$	0	0	0.00	0.00	∞
RF ambient conditions-Noise	E.6.1	3.0	R	$\sqrt{3}$	0	0	0.00	0.00	∞
RF ambient conditions-reflections	E.6.1	3.0	R	$\sqrt{3}$	0	0	0.00	0.00	∞
Probe positioner mechanical tolerance	E.6.2	1.4	R	$\sqrt{3}$	1	1	0.81	0.81	∞
Probe positioning with respect to phantom shell	E.6.3	1.4	R	$\sqrt{3}$	1	1	0.81	0.81	∞
Extrapolation, interpolation, and integrations algorithms for max. SAR evaluation	E.5	2.3	R	$\sqrt{3}$	0	0	0.00	0.00	∞
System check source (dipole)									
Deviation of experimental dipoles	E.6.4	2	N	1	1	1	2	2	∞
Input power and SAR drift measurement	8,6.6.4	5	R	$\sqrt{3}$	1	1	2.89	2.89	∞
Dipole axis to liquid distance	8,E.6.6	2	R	$\sqrt{3}$	1	1	1.15	1.15	∞
Phantom and tissue parameters									
Phantom shell uncertainty—shape, thickness, and permittivity	E.3.1	4	R	$\sqrt{3}$	1	1	2.31	2.31	∞
Uncertainty in SAR correction for deviations in permittivity and conductivity	E.3.2	1.9	N	1	1	0.84	1.90	1.60	∞
Liquid conductivity measurement	E.3.3	4	N	1	0.78	0.71	3.12	2.84	M
Liquid permittivity measurement	E.3.3	5	N	1	0.23	0.26	1.15	1.30	M
Liquid conductivity—temperature uncertainty	E.3.4	2.5	R	$\sqrt{3}$	0.78	0.71	1.13	1.02	∞
Liquid permittivity—temperature uncertainty	E.3.4	2.5	R	$\sqrt{3}$	0.23	0.26	0.33	0.38	∞
Combined Standard Uncertainty				RSS			5.564	5.205	
Expanded Uncertainty (95% Confidence interval)				K=2			11.128	10.410	



Attestation of Global Compliance(Shenzhen)Co.,Ltd.

Add: 2/F., Building 2, No.1-4, Chaxi Sanwei Technical Industrial Park, Gushu, Xixiang, Bao'an District, Shenzhen, Guangdong, China

Tel: +86-755 2523 4088

E-mail: agc@agc-cert.com

Service Hotline:400 089 2118

System Validation uncertainty for Dipole averaged over 1 gram / 10 gram.									
a	b	c	d	e f(d,k)	f	g	h cxf/e	i cxg/e	k
Uncertainty Component	Sec.	Tol (±%)	Prob. Dist.	Div.	Ci (1g)	Ci (10g)	1g Ui (±%)	10g Ui (±%)	vi
Measurement System									
Probe calibration	E.2.1	5.831	N	1	1	1	5.83	5.83	∞
Axial Isotropy	E.2.2	0.695	R	$\sqrt{3}$	1	1	0.40	0.40	∞
Hemispherical Isotropy	E.2.2	1.045	R	$\sqrt{3}$	0	0	0.00	0.00	∞
Boundary effect	E.2.3	1.0	R	$\sqrt{3}$	1	1	0.58	0.58	∞
Linearity	E.2.4	0.685	R	$\sqrt{3}$	1	1	0.40	0.40	∞
System detection limits	E.2.4	1.0	R	$\sqrt{3}$	1	1	0.58	0.58	∞
Modulation response	E.2.5	3.0	R	$\sqrt{3}$	0	0	0.00	0.00	∞
Readout Electronics	E.2.6	0.021	N	1	1	1	0.021	0.021	∞
Response Time	E.2.7	0.0	R	$\sqrt{3}$	0	0	0.00	0.00	∞
Integration Time	E.2.8	1.4	R	$\sqrt{3}$	0	0	0.00	0.00	∞
RF ambient conditions-Noise	E.6.1	3.0	R	$\sqrt{3}$	1	1	1.73	1.73	∞
RF ambient conditions-reflections	E.6.1	3.0	R	$\sqrt{3}$	1	1	1.73	1.73	∞
Probe positioner mechanical tolerance	E.6.2	1.4	R	$\sqrt{3}$	1	1	0.81	0.81	∞
Probe positioning with respect to phantom shell	E.6.3	1.4	R	$\sqrt{3}$	1	1	0.81	0.81	∞
Extrapolation, interpolation, and integrations algorithms for max. SAR evaluation	E.5	2.3	R	$\sqrt{3}$	1	1	1.33	1.33	∞
System check source (dipole)									
Deviation of experimental dipole from numerical dipole	E.6.4	5.0	N	1	1	1	5.00	5.00	∞
Input power and SAR drift measurement	8,6.6.4	5.0	R	$\sqrt{3}$	1	1	2.89	2.89	∞
Dipole axis to liquid distance	8,E.6.6	2.0	R	$\sqrt{3}$	1	1	1.15	1.15	∞
Phantom and tissue parameters									
Phantom shell uncertainty—shape, thickness, and permittivity	E.3.1	4.0	R	$\sqrt{3}$	1	1	2.31	2.31	∞
Uncertainty in SAR correction for deviations in permittivity and conductivity	E.3.2	1.9	N	1	1	0.84	1.90	1.60	∞
Liquid conductivity measurement	E.3.3	4.0	N	1	0.78	0.71	3.12	2.84	M
Liquid permittivity measurement	E.3.3	5.0	N	1	0.23	0.26	1.15	1.30	M
Liquid conductivity—temperature uncertainty	E.3.4	2.5	R	$\sqrt{3}$	0.78	0.71	1.13	1.02	∞
Liquid permittivity—temperature uncertainty	E.3.4	2.5	R	$\sqrt{3}$	0.23	0.26	0.33	0.38	∞
Combined Standard Uncertainty				RSS			9.718	9.517	
Expanded Uncertainty (95% Confidence interval)				K=2			19.437	19.035	



Attestation of Global Compliance(Shenzhen)Co.,Ltd.

Add: 2/F., Building 2, No.1-4, Chaxi Sanwei Technical Industrial Park, Gushu, Xixiang, Bao'an District, Shenzhen, Guangdong, China

Tel: +86-755 2523 4088

E-mail: agc@agc-cert.com

Service Hotline:400 089 2118

12. CONDUCTED POWER MEASUREMENT GSM BAND

Mode	Frequency(MHz)	Avg. Burst Power(dBm)	Duty cycle Factor(dBm)	Frame Power(dBm)
Maximum Power <1>				
GPRS 850 (1 Slot)	824.2	31.52	-9	22.52
	836.6	31.34	-9	22.34
	848.8	31.49	-9	22.49
GPRS 850 (2 Slot)	824.2	28.83	-6	22.83
	836.6	28.79	-6	22.79
	848.8	28.45	-6	22.45
GPRS 850 (3 Slot)	824.2	27.43	-4.26	23.17
	836.6	27.60	-4.26	23.34
	848.8	27.37	-4.26	23.11
GPRS 850 (4 Slot)	824.2	25.52	-3	22.52
	836.6	25.44	-3	22.44
	848.8	25.49	-3	22.49
EGPRS 850 (1 Slot)	824.2	26.79	-9	17.79
	836.6	26.69	-9	17.69
	848.8	27.42	-9	18.42
EGPRS 850 (2 Slot)	824.2	26.42	-6	20.42
	836.6	26.36	-6	20.36
	848.8	26.49	-6	20.49
EGPRS 850 (3 Slot)	824.2	26.12	-4.26	21.86
	836.6	26.34	-4.26	22.08
	848.8	26.15	-4.26	21.89
EGPRS 850 (4 Slot)	824.2	24.36	-3	21.36
	836.6	24.42	-3	21.42
	848.8	24.85	-3	21.85



Attestation of Global Compliance(Shenzhen)Co.,Ltd.

Add: 2/F., Building 2, No.1-4, Chaxi Sanwei Technial Industrial Park, Gushu,
Xixiang, Bao'an District, Shenzhen, Guangdong, China

Tel: +86-755 2523 4088

E-mail: agc@agc-cert.com

Service Hotline:400 089 2118

GSM BAND CONTINUE

Mode	Frequency(MHz)	Avg. Burst Power(dBm)	Duty cycle Factor(dBm)	Frame Power(dBm)
Maximum Power <1>				
GPRS1900 (1 Slot)	1850.2	29.44	-9	20.44
	1880	29.12	-9	20.12
	1909.8	29.36	-9	20.36
GPRS1900 (2 Slot)	1850.2	26.49	-6	20.49
	1880	26.07	-6	20.07
	1909.8	26.38	-6	20.38
GPRS1900 (3 Slot)	1850.2	25.12	-4.26	20.86
	1880	25.60	-4.26	21.34
	1909.8	25.69	-4.26	21.43
GPRS1900 (4 Slot)	1850.2	23.42	-3	20.42
	1880	23.38	-3	20.38
	1909.8	23.49	-3	20.49
EGPRS1900 (1 Slot)	1850.2	25.11	-9	16.11
	1880	25.35	-9	16.35
	1909.8	25.42	-9	16.42
EGPRS1900 (2 Slot)	1850.2	23.69	-6	17.69
	1880	23.44	-6	17.44
	1909.8	23.79	-6	17.79
EGPRS1900 (3 Slot)	1850.2	21.61	-4.26	17.35
	1880	21.52	-4.26	17.26
	1909.8	21.35	-4.26	17.09
EGPRS1900 (4 Slot)	1850.2	20.46	-3	17.46
	1880	20.47	-3	17.47
	1909.8	20.64	-3	17.64

Note 1:

The Frame Power (Source-based time-averaged Power) is scaled the maximum burst average power based on time slots. The calculated methods are show as following:

- Frame Power = Max burst power (1 Up Slot) – 9 dB
- Frame Power = Max burst power (2 Up Slot) – 6 dB
- Frame Power = Max burst power (3 Up Slot) – 4.26 dB
- Frame Power = Max burst power (4 Up Slot) – 3 dB



Attestation of Global Compliance(Shenzhen)Co.,Ltd.

Add: 2/F., Building 2, No.1-4, Chaxi Sanwei Technical Industrial Park, Gushu, Xixiang, Bao'an District, Shenzhen, Guangdong, China

Tel: +86-755 2523 4088 E-mail: agc@agc-cert.com Service Hotline:400 089 2118

**UMTS BAND
HSDPA Setup Configuration:**

- The EUT was connected to Base Station Agilent E5515C referred to the Setup Configuration.
- The RF path losses were compensated into the measurements.
- A call was established between EUT and Based Station with following setting:
 - (1) Set Gain Factors(β_c and β_d) parameters set according to each
 - (2) Set RMC 12.2Kbps+HSDPA mode.
 - (3) Set Cell Power=-86dBm
 - (4) Set HS-DSCH Configuration Type to FRC (H-set 1, QPSK)
 - (5) Select HSDPA Uplink Parameters
 - (6) Set Delta ACK, Delta NACK and Delta CQI=8
 - (7) Set Ack - Nack Repetition Factor to 3
 - (8) Set CQI Feedback Cycle (k) to 4ms
 - (9) Set CQI Repetition Factor to 2
 - (10) Power Ctrl Mode=All Up bits
- The transmitted maximum output power was recorded.

Table C.10.2.4: β values for transmitter characteristics tests with HS-DPCCH

Sub-test	β_c (Note5)	β_d	β_d (SF)	β_c/β_d	β_{HS} (Note1, Note 2)	CM (dB) (Note 3)	MPR (dB) (Note 3)
1	2/15	15/15	64	2/15	4/15	0.0	0.0
2	12/15(Note 4)	15/15(Note 4)	64	12/15(Note 4)	24/15	1.0	0.0
3	15/15	8/15	64	15/8	30/15	1.5	0.5
4	15/15	4/15	64	15/4	30/15	1.5	0.5

Note 1: $\Delta ACK, \Delta NACK$ and $\Delta CQI = 30/15$ with $\beta_{hs} = 30/15 * \beta_c$.

Note 2: For the HS-DPCCH power mask requirement test in clause 5.2C, 5.7A, and the Error Vector Magnitude (EVM) with HS-DPCCH test in clause 5.13.1A, and HSDPA EVM with phase discontinuity in clause 5.13.1AA, ΔACK and $\Delta NACK = 30/15$ with $\beta_{hs} = 30/15 * \beta_c$, and $\Delta CQI = 24/15$ with $\beta_{hs} = 24/15 * \beta_c$.

Note 3: CM = 1 for $\beta_c/\beta_d = 12/15, hs/ c = 24/15$. For all other combinations of DPDCH, DPCCH and HS-DPCCH the MPR is based on the relative CM difference. This is applicable for only UEs that support HSDPA in release 6 and later releases.

Note 4: For subtest 2 the c/ d ratio of 12/15 for the TFC during the measurement period (TF1, TF0) is achieved by setting the signalled gain factors for the reference TFC (TF1, TF1) to $c = 11/15$ and $d = 15/15$.



HSUPA Setup Configuration:

- The EUT was connected to Base Station Agilent E5515C referred to the Setup Configuration.
- The RF path losses were compensated into the measurements.
- A call was established between EUT and Base Station with following setting * :
 - (1) Call Configs = 5.2B, 5.9B, 5.10B, and 5.13.2B with QPSK
 - (2) Set the Gain Factors (β_c and β_d) and parameters (AG Index) were set according to each specific sub-test in the following table, C11.1.3, quoted from the TS 34.121
 - (3) Set Cell Power = -86 dBm
 - (4) Set Channel Type = 12.2k + HSPA
 - (5) Set UE Target Power
 - (6) Power Ctrl Mode= Alternating bits
 - (7) Set and observe the E-TFCI
 - (8) Confirm that E-TFCI is equal to the target E-TFCI of 75 for sub-test 1, and other subtest's E-TFCI
- The transmitted maximum output power was recorded.

Table C.11.1.3: β values for transmitter characteristics tests with HS-DPCCH and E-DCH

Sub-test	β_c	β_d	β_d (SF)	β_c/β_d	β_{HS} (Note 1)	β_{ec}	β_{ed} (Note 4) (Note 5)	β_{ed} (SF)	β_{ed} (Codes)	CM (dB) (Note 2)	MPR (dB) (Note 2) (Note 6)	AG Index (Note 5)	E-TF CI
1	11/15 (Note 3)	15/15 (Note 3)	64	11/15 (Note 3)	22/15	209/225	1309/225	4	1	1.0	0.0	20	75
2	6/15	15/15	64	6/15	12/15	12/15	94/75	4	1	3.0	2.0	12	67
3	15/15	9/15	64	15/9	30/15	30/15	β_{ed1} : 47/15 β_{ed2} : 47/15	4 4	2	2.0	1.0	15	92
4	2/15	15/15	64	2/15	4/15	2/15	56/75	4	1	3.0	2.0	17	71
5	15/15	0	-	-	5/15	5/15	47/15	4	1	1.0	0.0	12	67

Note 1: For sub-test 1 to 4, ΔACK , $\Delta NACK$ and $\Delta CQI = 30/15$ with $\beta_{hs} = 30/15 * \beta_c$. For sub-test 5, ΔACK , $\Delta NACK$ and $\Delta CQI = 5/15$ with $\beta_{hs} = 5/15 * \beta_c$.

Note 2: CM = 1 for $\beta_c/\beta_d = 12/15$, $hs/c = 24/15$. For all other combinations of DPDCH, DPCCH, HS-DPCCH, E-DPDCH and E-DPCCH the MPR is based on the relative CM difference.

Note 3: For subtest 1 the c/d ratio of 11/15 for the TFC during the measurement period (TF1, TF0) is achieved by setting the signalled gain factors for the reference TFC (TF1, TF1) to $c = 10/15$ and $d = 15/15$.

Note 4: In case of testing by UE using E-DPDCH Physical Layer category 1, Sub-test 3 is omitted according to TS25.306 Table 5.1g.

Note 5: β_{ed} cannot be set directly; it is set by Absolute Grant Value.

Note 6: For subtests 2, 3 and 4, UE may perform E-DPDCH power scaling at max power which could results in slightly smaller MPR values.



UMTS BAND II

Mode	Frequency (MHz)	Avg. Burst Power (dBm)
WCDMA 1900 RMC	1852.4	22.17
	1880	22.90
	1907.6	22.19
WCDMA 1900 AMR	1852.4	22.10
	1880	22.35
	1907.6	22.49
HSDPA Subtest 1	1852.4	21.14
	1880	20.95
	1907.6	21.25
HSDPA Subtest 2	1852.4	20.42
	1880	20.20
	1907.6	20.42
HSDPA Subtest 3	1852.4	20.51
	1880	20.14
	1907.6	20.40
HSDPA Subtest 4	1852.4	20.39
	1880	20.17
	1907.6	20.39
HSUPA Subtest 1	1852.4	18.88
	1880	18.51
	1907.6	18.83
HSUPA Subtest 2	1852.4	18.99
	1880	18.72
	1907.6	19.01
HSUPA Subtest 3	1852.4	19.95
	1880	19.57
	1907.6	19.88
HSUPA Subtest 4	1852.4	18.63
	1880	18.23
	1907.6	18.56
HSUPA Subtest 5	1852.4	17.72
	1880	17.60
	1907.6	17.71



Attestation of Global Compliance(Shenzhen)Co.,Ltd.

Add: 2/F., Building 2, No.1-4, Chaxi Sanwei Technial Industrial Park, Gushu, Xixiang, Bao'an District, Shenzhen, Guangdong, China

Tel: +86-755 2523 4088

E-mail: agc@agc-cert.com

Service Hotline:400 089 2118

UMTS BAND V

Mode	Frequency (MHz)	Avg. Burst Power (dBm)
WCDMA 850 RMC	826.4	23.35
	836.6	23.58
	846.6	23.43
WCDMA 850 AMR	826.4	22.49
	836.6	22.52
	846.6	22.60
HSDPA Subtest 1	826.4	22.39
	836.6	22.66
	846.6	22.52
HSDPA Subtest 2	826.4	21.62
	836.6	21.87
	846.6	22.72
HSDPA Subtest 3	826.4	21.54
	836.6	21.83
	846.6	22.73
HSDPA Subtest 4	826.4	21.60
	836.6	21.83
	846.6	22.68
HSUPA Subtest 1	826.4	20.27
	836.6	20.38
	846.6	20.30
HSUPA Subtest 2	826.4	20.34
	836.6	20.56
	846.6	21.44
HSUPA Subtest 3	826.4	21.23
	836.6	21.38
	846.6	22.23
HSUPA Subtest 4	826.4	19.79
	836.6	19.98
	846.6	20.86
HSUPA Subtest 5	826.4	19.24
	836.6	19.53
	846.6	22.20



Attestation of Global Compliance(Shenzhen)Co.,Ltd.

Add: 2/F., Building 2, No.1-4, Chaxi Sanwei Technical Industrial Park, Gushu, Xixiang, Bao'an District, Shenzhen, Guangdong, China

Tel: +86-755 2523 4088

E-mail: agc@agc-cert.com

Service Hotline:400 089 2118

According to 3GPP 25.101 sub-clause 6.2.2 , the maximum output power is allowed to be reduced by following the table.

Table 6.1aA: UE maximum output power with HS-DPCCH and E-DCH

UE Transmit Channel Configuration	CM(db)	MPR(db)
For all combinations of ,DPDCH,DPCCH HS-DPDCH,E-DPDCH and E-DPCCH	$0 \leq CM \leq 3.5$	$MAX(CM-1,0)$

Note: CM=1 for $\beta_o/\beta_d=12/15$, $\beta_{hs}/\beta_c=24/15$. For all other combinations of DPDCH, DPCCH, HS-DPCCH, E-DPDCH and E-DPCCH the MPR is based on the relative CM difference.

The device supports MPR to solve linearity issues (ACLR or SEM) due to the higher peak-to average ratios (PAR) of the HSUPA signal. This prevents saturating the full range of the TX DAC inside of device and provides a reduced power output to the RF transceiver chip according to the Cubic Metric (a function of the combinations of DPDCH, DPCCH, HS-DPCCH, E-DPDCH and E-DPCCH).

When E-DPDCH channels are present the beta gains on those channels are reduced firsts to try to get the power under the allowed limit. If the beta gains are lowered as far as possible, then a hard limiting is applied at the maximum allowed level.

The SW currently recalculates the cubic metric every time the beta gains on the E-DPDCH are reduced. The cubic metric will likely get lower each time this is done .However, there is no reported reduction of maximum output power in the HSUPA mode since the device also provides a compensation for the power back-off by increasing the gain of TX_AG in the transceiver (PA) device.

The end effect is that the DUT output power is identical to the case where there is no MPR in the device.



LTE Band

LTE (TDD) Considerations

For Time-Division Duplex (TDD) systems, SAR must be tested using a fixed periodic duty factor according to the highest transmission duty factor implemented for the device and supported by the defined 3GPP LTE TDD configurations.

SAR was tested with the highest transmission duty factor (63.33%) using Uplink-downlink configuration 0 and Special subframe configuration 7.

LTE TDD Band 40 supports 3GPP TS 36.211 section 4.2 for Type 2 Frame Structure and Table 4.2-2 for uplink-downlink configurations and Table 4.2-1 for Special subframe configurations.

Table 4.2-1: Configuration of special subframe (lengths of DwPTS/GP/UpPTS)

Special subframe configuration	Normal cyclic prefix in downlink			Extended cyclic prefix in downlink		
	DwPTS	UpPTS		DwPTS	UpPTS	
		Normal cyclic prefix in uplink	Extended cyclic prefix in uplink		Normal cyclic prefix in uplink	Extended cyclic prefix in uplink
0	$6592 \cdot T_s$	$2192 \cdot T_s$	$2560 \cdot T_s$	$7680 \cdot T_s$	$2192 \cdot T_s$	$2560 \cdot T_s$
1	$19760 \cdot T_s$			$20480 \cdot T_s$		
2	$21952 \cdot T_s$			$23040 \cdot T_s$		
3	$24144 \cdot T_s$			$25600 \cdot T_s$		
4	$26336 \cdot T_s$	$4384 \cdot T_s$	$5120 \cdot T_s$	$7680 \cdot T_s$	$4384 \cdot T_s$	$5120 \cdot T_s$
5	$6592 \cdot T_s$			$20480 \cdot T_s$		
6	$19760 \cdot T_s$			$23040 \cdot T_s$		
7	$21952 \cdot T_s$			$12800 \cdot T_s$		
8	$24144 \cdot T_s$			-		
9	$13168 \cdot T_s$	-	-	-	-	-

Table 4.2-2: Uplink-downlink configurations

Uplink-downlink configuration	Downlink-to-Uplink Switch-point periodicity	Subframe number										
		0	1	2	3	4	5	6	7	8	9	
0	5 ms	D	S	U	U	U	D	S	U	U	U	
1	5 ms	D	S	U	U	D	D	S	U	U	D	
2	5 ms	D	S	U	D	D	D	S	U	D	D	
3	10 ms	D	S	U	U	U	D	D	D	D	D	
4	10 ms	D	S	U	U	D	D	D	D	D	D	
5	10 ms	D	S	U	D	D	D	D	D	D	D	
6	5 ms	D	S	U	U	U	D	S	U	U	D	



Calculated Duty Cycle

Uplink-Downlink Configuration	Downlink-to-Uplink Switch-point Periodicity	Subframe Number										Calculated Duty Cycle(%)
		0	1	2	3	4	5	6	7	8	9	
0	5ms	D	S	U	U	U	D	S	U	U	U	63.33
1	5ms	D	S	U	U	D	D	S	U	U	D	43.33
2	5ms	D	S	U	D	D	D	S	U	D	D	23.33
3	10ms	D	S	U	U	U	D	D	D	D	D	31.67
4	10ms	D	S	U	U	D	D	D	D	D	D	21.67
5	10ms	D	S	U	D	D	D	D	D	D	D	11.67
6	5ms	D	S	U	U	U	D	S	U	U	D	53.33

Note: Calculated Duty Cycle = Extended cyclic prefix in uplink x (Ts) x # of S + # of U

Example for Calculated Duty Cycle for Uplink-Downlink Configuration 0:

Calculated Duty Cycle = $5120 \times [1/(15000 \times 2048)] \times 2 + 6 \text{ ms} = 63.33\%$

where

$T_s = 1/(15000 \times 2048)$ seconds



Attestation of Global Compliance(Shenzhen)Co.,Ltd.

Add: 2/F., Building 2, No.1-4, Chaxi Sanwei Technial Industrial Park, Gushu, Xixiang, Bao'an District, Shenzhen, Guangdong, China

Tel: +86-755 2523 4088

E-mail: agc@agc-cert.com

Service Hotline:400 089 2118

LTE Band

Conducted Power of LTE Band 2(dBm)									
Bandwidth	Modulation	RB size	RB offset	Target MPR	Channel	Channel	Channel		
					18607	18900	19193		
1.4MHz	QPSK	1	0	0	23.92	23.09	23.31		
			2	0	24.03	23.19	23.45		
			5	0	23.56	23.08	23.26		
		3	0	0	23.50	23.19	23.37		
			1	0	23.52	23.17	23.39		
			2	0	23.52	23.22	23.40		
		6	0	1	22.46	22.11	22.33		
		16QAM	1	0	1	22.54	22.26	22.21	
				2	1	22.72	22.42	22.35	
	5			1	22.53	22.25	22.16		
	3		0	1	23.51	23.18	23.40		
			1	1	23.51	23.19	23.38		
			2	1	23.50	23.21	23.40		
	6		0	2	21.50	21.01	21.34		
	Bandwidth		Modulation	RB size	RB offset	Target MPR	Channel	Channel	Channel
							18615	18900	19185
	3MHz	QPSK	1	0	0	23.45	23.18	23.35	
				8	0	23.41	23.15	23.37	
14				0	23.51	23.10	23.30		
8			0	1	22.46	22.08	22.35		
			4	1	22.47	22.11	22.34		
			8	1	22.48	22.12	22.31		
15			0	1	22.47	22.13	22.35		
16QAM			1	0	1	22.64	22.34	22.28	
				8	1	22.61	22.28	22.24	
		14		1	22.64	22.28	22.23		
		8	0	2	22.48	22.08	22.37		
			4	2	22.47	22.08	22.34		
			8	2	22.49	22.11	22.33		
		15	0	2	21.48	21.07	21.30		



Attestation of Global Compliance(Shenzhen)Co.,Ltd.

Add: 2/F., Building 2, No.1-4, Chaxi Sanwei Technical Industrial Park, Gushu, Xixiang, Bao'an District, Shenzhen, Guangdong, China

Tel: +86-755 2523 4088

E-mail: agc@agc-cert.com

Service Hotline:400 089 2118

Conducted Power of LTE Band 2(dBm)							
Bandwidth	Modulation	RB size	RB offset	Target MPR	Channel	Channel	Channel
					18625	18900	19175
5MHz	QPSK	1	0	0	23.45	23.14	23.40
			12	0	23.54	23.24	23.49
			24	0	23.38	23.08	23.31
		12	0	1	22.44	22.15	22.40
			6	1	22.43	22.15	22.41
			13	1	22.44	22.13	22.34
	25	0	1	22.51	22.17	22.43	
	16QAM	1	0	1	22.46	22.32	22.41
			12	1	22.55	22.41	22.52
			24	1	22.46	22.24	22.31
		12	0	2	22.40	22.11	22.40
			6	2	22.41	22.15	22.42
			13	2	22.48	22.06	22.30
	25	0	2	21.50	21.13	21.45	
	Bandwidth	Modulation	RB size	RB offset	Target MPR	Channel	Channel
					18650	18900	19150
10MHz	QPSK	1	0	0	23.40	23.19	23.44
			24	0	23.54	23.21	23.57
			49	0	23.36	23.03	23.34
		25	0	1	22.44	22.22	22.59
			12	1	22.47	22.22	22.59
			25	1	22.50	22.18	22.47
	50	0	1	22.51	22.18	22.55	
	16QAM	1	0	1	22.61	22.32	22.33
			24	1	22.73	22.41	22.46
			49	1	22.53	22.18	22.19
		25	0	2	22.49	22.23	22.60
			12	2	22.48	22.22	22.59
			25	2	22.52	22.20	22.46
	50	0	2	21.49	21.21	21.56	



Attestation of Global Compliance(Shenzhen)Co.,Ltd.

Add: 2/F., Building 2, No.1-4, Chaxi Sanwei Technial Industrial Park, Gushu, Xixiang, Bao'an District, Shenzhen, Guangdong, China

Tel: +86-755 2523 4088 E-mail: agc@agc-cert.com Service Hotline:400 089 2118

Conducted Power of LTE Band 2(dBm)									
Bandwidth	Modulation	RB size	RB offset	Target MPR	Channel	Channel	Channel		
					18675	18900	19125		
15MHz	QPSK	1	0	0	23.36	23.14	23.18		
			38	0	23.40	23.14	23.49		
			74	0	23.30	22.92	23.28		
		36	0	1	22.49	22.19	22.52		
			18	1	22.47	22.18	22.49		
			37	1	22.50	22.21	22.53		
		75	0	1	22.50	22.21	22.53		
		16QAM	1	0	1	22.56	22.41	22.06	
				38	1	22.59	22.41	22.37	
	74			1	22.50	22.21	22.16		
	36		0	2	22.53	22.23	22.54		
			18	2	22.48	22.21	22.52		
			37	2	22.49	22.19	22.51		
	75		0	2	21.43	21.18	21.47		
	Bandwidth		Modulation	RB size	RB offset	Target MPR	Channel	Channel	Channel
							18700	18900	19100
	20MHz	QPSK	1	0	0	23.29	23.10	22.75	
				49	0	23.56	23.28	23.39	
99				0	23.17	22.80	23.01		
50			0	1	22.42	22.22	22.35		
			25	1	22.42	22.23	22.30		
			49	1	22.38	22.10	22.34		
100			0	1	22.38	22.18	22.34		
16QAM			1	0	1	22.31	22.22	21.86	
				49	1	22.60	22.43	22.51	
		99		1	22.15	21.98	22.09		
		50	0	2	22.41	22.22	22.36		
			25	2	22.39	22.20	22.32		
			49	2	22.37	22.10	22.35		
		100	0	2	21.35	21.15	21.35		



Attestation of Global Compliance(Shenzhen)Co.,Ltd.

Add: 2/F., Building 2, No.1-4, Chaxi Sanwei Technial Industrial Park, Gushu, Xixiang, Bao'an District, Shenzhen, Guangdong, China

Tel: +86-755 2523 4088 E-mail: agc@agc-cert.com Service Hotline:400 089 2118

Conducted Power of LTE Band 5(dBm)									
Bandwidth	Modulation	RB size	RB offset	Target MPR	Channel	Channel	Channel		
					20407	20525	20643		
1.4MHz	QPSK	1	0	0	23.44	22.87	22.93		
			2	0	23.41	23.00	23.05		
			5	0	23.26	22.87	22.89		
		3	0	0	23.46	22.83	23.01		
			1	0	23.45	22.87	23.01		
			2	0	23.38	22.92	23.01		
		6	0	1	22.38	21.93	22.08		
		16QAM	1	0	1	22.50	22.03	22.14	
				2	1	22.62	22.21	22.34	
	5			1	22.38	22.05	22.13		
	3		0	1	23.42	22.87	23.02		
			1	1	23.44	22.84	23.02		
			2	1	23.36	22.92	23.01		
	6		0	2	21.37	20.88	21.13		
	Bandwidth		Modulation	RB size	RB offset	Target MPR	Channel	Channel	Channel
							20415	20525	20635
	3MHz	QPSK	1	0	0	23.54	22.94	23.08	
				7	0	23.26	22.95	23.02	
14				0	23.12	22.93	22.97		
8			0	1	22.25	21.97	22.12		
			4	1	22.26	21.96	22.13		
			7	1	22.28	21.99	22.16		
15			0	1	22.30	21.97	22.15		
16QAM			1	0	1	22.67	22.13	22.38	
				7	1	22.42	22.18	22.30	
		14		1	22.23	22.17	22.23		
		8	0	2	22.30	21.94	22.12		
			4	2	22.30	21.97	22.10		
			7	2	22.29	21.98	22.09		
		15	0	2	21.29	20.86	21.15		



Attestation of Global Compliance(Shenzhen)Co.,Ltd.

Add: 2/F., Building 2, No.1-4, Chaxi Sanwei Technical Industrial Park, Gushu, Xixiang, Bao'an District, Shenzhen, Guangdong, China

Tel: +86-755 2523 4088

E-mail: agc@agc-cert.com

Service Hotline:400 089 2118

Conducted Power of LTE Band 5(dBm)									
Bandwidth	Modulation	RB size	RB offset	Target MPR	Channel	Channel	Channel		
					20425	20525	20625		
5MHz	QPSK	1	0	0	23.45	22.85	23.26		
			12	0	23.17	22.99	23.18		
			24	0	22.86	22.87	22.96		
		12	0	1	22.20	21.91	22.28		
			6	1	22.22	21.94	22.28		
			11	1	22.02	21.98	23.24		
		25	0	1	22.16	22.01	23.35		
		16QAM	1	0	1	22.47	22.02	22.32	
				12	1	22.16	22.27	22.32	
	24			1	21.88	22.16	22.06		
	12		0	2	22.18	21.91	23.38		
			6	2	22.21	21.92	23.37		
			11	2	22.02	21.98	23.23		
	25		0	2	21.13	20.97	22.37		
	Bandwidth		Modulation	RB size	RB offset	Target MPR	Channel	Channel	Channel
							20450	20525	20600
	10MHz	QPSK	1	0	0	23.58	23.40	24.25	
				24	0	23.55	23.73	24.47	
49				0	23.46	23.70	24.29		
25			0	1	22.51	22.63	23.46		
			12	1	22.50	22.65	23.46		
			25	1	22.42	22.74	23.37		
50			0	1	22.45	22.71	23.44		
16QAM			1	0	1	22.75	22.59	23.56	
				24	1	22.66	22.97	23.67	
		49		1	22.59	22.94	23.56		
		25	0	2	22.50	22.68	23.46		
			12	2	22.49	22.65	23.49		
			25	2	22.45	22.71	23.38		
		50	0	2	21.41	21.69	22.43		



Attestation of Global Compliance(Shenzhen)Co.,Ltd.

Add: 2/F., Building 2, No.1-4, Chaxi Sanwei Technial Industrial Park, Gushu, Xixiang, Bao'an District, Shenzhen, Guangdong, China

Tel: +86-755 2523 4088 E-mail: agc@agc-cert.com Service Hotline:400 089 2118

Conducted Power of LTE Band 7 (dBm)

Bandwidth	Modulation	RB size	RB offset	Target MPR	Channel	Channel	Channel	
					20775	21100	21425	
5MHz	QPSK	1	0	0	23.19	22.89	23.43	
			12	0	23.42	23.03	23.48	
			24	0	23.34	22.87	23.32	
		12	0	1	22.13	21.86	22.40	
			6	1	22.18	21.86	22.41	
			13	1	22.32	21.87	22.26	
	25	0	1	22.30	21.87	22.30		
	16QAM	1	0	1	22.09	22.03	22.34	
			12	1	22.22	22.13	22.44	
			24	1	22.28	22.00	22.26	
		12	0	2	22.15	21.89	22.35	
			6	2	22.14	21.87	22.36	
			13	2	22.30	21.87	22.24	
		25	0	2	21.30	20.92	21.34	
		Bandwidth	Modulation	RB size	RB offset	Target MPR	Channel	Channel
20800							21100	21400
10MHz	QPSK	1	0	0	23.19	22.93	23.56	
			24	0	23.44	23.00	23.51	
			49	0	23.47	22.91	23.34	
		25	0	1	22.26	21.91	22.50	
			12	1	22.26	21.96	22.48	
			25	1	22.49	21.93	22.30	
	50	0	1	22.37	21.94	22.38		
	16QAM	1	0	1	22.35	22.03	22.33	
			24	1	22.62	22.10	22.36	
			49	1	22.60	22.01	22.21	
		25	0	2	22.24	21.93	22.47	
			12	2	22.26	21.94	22.48	
			25	2	22.48	21.94	22.32	
		50	0	2	21.39	21.00	21.30	



Attestation of Global Compliance(Shenzhen)Co.,Ltd.

Add: 2/F., Building 2, No.1-4, Chaxi Sanwei Technial Industrial Park, Gushu, Xixiang, Bao'an District, Shenzhen, Guangdong, China

Tel: +86-755 2523 4088

E-mail: agc@agc-cert.com

Service Hotline:400 089 2118

Conducted Power of LTE Band 7 (dBm)

Bandwidth	Modulation	RB size	RB offset	Target MPR	Channel	Channel	Channel	
					20825	21100	21375	
15MHz	QPSK	1	0	0	23.10	22.90	23.42	
			37	0	23.47	22.88	23.26	
			74	0	23.24	22.87	22.42	
		37	0	1	22.45	22.00	22.40	
			16	1	22.44	22.03	22.43	
			35	1	22.43	22.03	22.43	
	75	0	1	22.48	22.00	23.22		
	16QAM	1	0	1	22.21	22.08	22.06	
			37	1	22.54	22.13	22.33	
			74	1	22.35	22.10	22.09	
		37	0	2	22.44	22.02	22.43	
			16	2	22.44	22.01	22.41	
			35	2	22.42	21.99	22.43	
		75	0	2	21.43	23.22	21.34	
		Bandwidth	Modulation	RB size	RB offset	Target MPR	Channel	Channel
20850							21100	21350
20MHz	QPSK	1	0	0	23.59	22.78	22.82	
			49	0	22.97	23.03	23.43	
			99	0	22.24	22.81	22.98	
		50	0	1	22.23	21.96	22.24	
			25	1	22.37	21.99	22.22	
			49	1	22.29	21.91	22.29	
	100	0	1	21.97	21.92	22.24		
	16QAM	1	0	1	22.55	21.88	21.88	
			49	1	21.97	22.15	22.40	
			99	1	22.23	21.92	22.06	
		50	0	2	22.21	21.98	22.22	
			25	2	22.39	21.98	22.21	
			49	2	21.30	21.92	22.25	
		100	0	2	23.59	21.00	21.20	



Attestation of Global Compliance(Shenzhen)Co.,Ltd.

Add: 2/F., Building 2, No.1-4, Chaxi Sanwei Technial Industrial Park, Gushu, Xixiang, Bao'an District, Shenzhen, Guangdong, China

Tel: +86-755 2523 4088

E-mail: agc@agc-cert.com

Service Hotline:400 089 2118

Conducted Power of LTE Band 12(dBm)									
Bandwidth	Modulation	RB size	RB offset	Target MPR	Channel	Channel	Channel		
					23017	23095	23173		
1.4MHz	QPSK	1	0	0	24.26	24.38	23.93		
			2	0	24.33	24.39	24.08		
			5	0	24.19	24.37	23.94		
		3	0	0	24.20	24.39	23.93		
			1	0	24.23	24.40	23.93		
			2	0	24.22	24.42	23.89		
		6	0	1	23.25	23.45	23.06		
		16QAM	1	0	1	23.19	23.35	22.78	
				2	1	23.27	23.55	22.87	
	5			1	23.16	23.37	22.72		
	3		0	1	24.21	24.38	23.91		
			1	1	24.20	24.38	23.92		
			2	1	24.22	24.43	23.89		
	6		0	2	22.20	22.25	21.93		
	Bandwidth		Modulation	RB size	RB offset	Target MPR	Channel	Channel	Channel
							23025	23095	23165
	3MHz	QPSK	1	0	0	24.19	24.40	24.16	
				7	0	24.21	24.40	24.02	
14				0	24.26	24.34	23.98		
8			0	1	23.18	23.36	23.00		
			4	1	23.19	23.33	23.01		
			7	1	23.19	23.39	23.01		
15			0	1	23.21	23.38	23.01		
16QAM			1	0	1	23.30	23.48	22.98	
				7	1	23.31	23.45	22.85	
		14		1	23.38	23.42	22.79		
		8	0	2	23.19	23.38	23.01		
			4	2	23.20	23.37	23.00		
			7	2	23.21	23.36	23.00		
		15	0	2	22.19	22.27	21.89		



Attestation of Global Compliance(Shenzhen)Co.,Ltd.

Add: 2/F., Building 2, No.1-4, Chaxi Sanwei Technical Industrial Park, Gushu, Xixiang, Bao'an District, Shenzhen, Guangdong, China

Tel: +86-755 2523 4088

E-mail: agc@agc-cert.com

Service Hotline:400 089 2118

Conducted Power of LTE Band 12(dBm)							
Bandwidth	Modulation	RB size	RB offset	Target MPR	Channel	Channel	Channel
					23035	23095	23155
5MHz	QPSK	1	0	0	24.22	24.34	24.22
			12	0	24.35	24.47	24.19
			24	0	24.32	24.32	24.01
		12	0	1	23.26	23.30	23.21
			6	1	23.22	23.30	23.23
			13	1	23.29	23.37	23.02
	25	0	1	23.27	23.40	23.14	
	16QAM	1	0	1	23.11	23.46	23.16
			12	1	23.29	23.57	23.12
			24	1	23.29	23.43	22.82
		12	0	2	23.22	23.35	23.25
			6	2	23.23	23.31	23.21
			13	2	23.29	23.35	23.03
	25	0	2	22.27	22.33	22.12	
	Bandwidth	Modulation	RB size	RB offset	Target MPR	Channel	Channel
					23060	23095	23130
10MHz	QPSK	1	0	0	24.15	24.31	24.36
			24	0	24.43	24.48	24.36
			49	0	24.36	24.18	23.99
		25	0	1	23.41	23.34	23.39
			12	1	23.41	23.33	23.39
			25	1	23.50	23.32	23.12
	50	0	1	23.42	23.36	23.20	
	16QAM	1	0	1	23.23	23.40	23.23
			24	1	23.53	23.53	23.17
			49	1	23.47	23.29	22.81
		25	0	2	23.40	23.34	23.40
			12	2	23.41	23.34	23.38
			25	2	23.50	23.31	23.14
	50	0	2	22.36	22.31	22.19	



Attestation of Global Compliance(Shenzhen)Co.,Ltd.

Add: 2/F., Building 2, No.1-4, Chaxi Sanwei Technial Industrial Park, Gushu, Xixiang, Bao'an District, Shenzhen, Guangdong, China

Tel: +86-755 2523 4088

E-mail: agc@agc-cert.com

Service Hotline:400 089 2118

Conducted Power of LTE Band 17(dBm)									
Bandwidth	Modulation	RB size	RB offset	Target MPR	Channel	Channel	Channel		
					23755	23790	23825		
5MHz	QPSK	1	0	0	23.47	23.54	23.32		
			12	0	23.60	23.55	23.26		
			24	0	23.48	23.33	23.02		
		12	0	1	22.48	22.52	22.33		
			6	1	22.47	22.52	22.35		
			13	1	22.59	22.52	22.13		
		25	0	1	22.52	22.49	22.25		
		16QAM	1	0	1	22.59	22.54	22.34	
				12	1	22.77	22.43	22.19	
	24			1	22.64	22.34	21.91		
	12		0	2	22.45	22.46	22.38		
			6	2	22.56	22.56	22.34		
			13	2	22.62	22.44	22.15		
	25		0	2	21.54	21.58	21.24		
	Bandwidth		Modulation	RB size	RB offset	Target MPR	Channel	Channel	Channel
							23780	23790	23800
	10MHz	QPSK	1	0	0	23.46	23.45	23.53	
				24	0	23.54	23.55	23.51	
49				0	23.22	23.10	23.05		
25			0	1	22.52	22.53	22.56		
			12	1	22.51	22.54	22.58		
			25	1	22.32	22.29	22.26		
50			0	1	22.42	22.48	22.41		
16QAM			1	0	1	22.63	22.59	22.36	
				24	1	22.64	22.58	22.33	
		49		1	22.36	22.18	21.95		
		25	0	2	22.48	22.49	22.50		
			12	2	22.51	22.53	22.55		
			25	2	22.32	22.41	22.28		
		50	0	2	21.43	21.46	21.45		



Attestation of Global Compliance(Shenzhen)Co.,Ltd.

Add: 2/F., Building 2, No.1-4, Chaxi Sanwei Technical Industrial Park, Gushu, Xixiang, Bao'an District, Shenzhen, Guangdong, China

Tel: +86-755 2523 4088

E-mail: agc@agc-cert.com

Service Hotline:400 089 2118

Avg. Output Power of LTE Band 40(dBm)									
Bandwidth	Modulation	RB size	RB offset	Target MPR	Channel	Channel	Channel		
					38675	39150	39625		
5MHz	QPSK	1	0	0	23.14	22.14	23.37		
			12	0	23.13	22.21	23.46		
			24	0	22.85	22.08	23.30		
		12	0	1	22.09	21.13	22.30		
			6	1	22.06	21.14	22.30		
			11	1	22.06	21.14	22.31		
		25	0	1	22.07	21.13	22.29		
		16QAM	1	0	1	22.12	21.32	22.32	
				12	1	22.10	21.39	22.37	
	24			1	21.86	21.25	22.18		
	12		0	2	22.08	21.13	22.33		
			6	2	22.08	21.16	22.33		
			11	2	22.04	21.17	22.31		
	25		0	2	21.17	20.23	20.98		
	Bandwidth		Modulation	RB size	RB offset	Target MPR	Channel	Channel	Channel
							38700	39150	39600
	10MHz	QPSK	1	0	0	23.23	22.30	23.52	
				24	0	23.19	22.39	23.73	
49				0	22.59	22.00	23.35		
25			0	1	22.00	21.11	22.45		
			12	1	22.02	21.11	22.45		
			25	1	21.82	21.06	22.36		
50			0	1	21.93	21.12	22.44		
16QAM			1	0	1	22.41	21.35	22.41	
				24	1	22.35	21.44	22.55	
		49		1	21.77	21.20	22.19		
		25	0	2	22.03	21.10	22.44		
			12	2	22.01	21.10	22.48		
			25	2	21.79	21.08	22.38		
		50	0	2	20.99	20.20	21.38		



Attestation of Global Compliance(Shenzhen)Co.,Ltd.

Add: 2/F., Building 2, No.1-4, Chaxi Sanwei Technial Industrial Park, Gushu, Xixiang, Bao'an District, Shenzhen, Guangdong, China

Tel: +86-755 2523 4088 E-mail: agc@agc-cert.com Service Hotline:400 089 2118

Avg. Output Power of LTE Band 40(dBm)

Bandwidth	Modulation	RB size	RB offset	Target MPR	Channel	Channel	Channel	
					38725	39150	39575	
15MHz	QPSK	1	0	0	23.15	22.09	23.38	
			37	0	22.78	22.19	23.44	
			74	0	22.23	22.14	23.19	
		37	0	1	21.83	21.17	22.44	
			16	1	21.83	21.17	22.45	
			35	1	21.83	21.18	22.44	
		75	0	1	21.83	21.18	22.45	
		16QAM	1	0	1	22.27	21.24	22.28
				37	1	21.96	21.30	22.29
	74			1	21.40	21.28	21.97	
	37		0	2	21.84	21.18	22.44	
			16	2	21.83	21.17	22.44	
			35	2	21.84	21.18	22.44	
	75	0	2	20.84	20.23	21.37		
	Bandwidth	Modulation	RB size	RB offset	Target MPR	Channel	Channel	Channel
					38750	39150	39550	
20MHz	QPSK	1	0	0	22.94	21.89	23.30	
			49	0	22.84	22.42	23.78	
			99	0	21.81	22.24	23.11	
		50	0	1	21.86	21.12	22.54	
			25	1	21.85	21.15	22.52	
			49	1	21.40	21.14	22.42	
		100	0	1	21.59	21.13	22.48	
		16QAM	1	0	1	21.96	21.05	22.24
				49	1	21.85	21.57	22.69
	99			1	20.84	21.42	21.99	
	50		0	2	20.94	20.36	21.52	
			25	2	20.97	20.35	21.51	
			49	2	20.48	20.32	21.42	
	100	0	2	20.64	20.37	21.43		



Attestation of Global Compliance(Shenzhen)Co.,Ltd.

Add: 2/F., Building 2, No.1-4, Chaxi Sanwei Technial Industrial Park, Gushu, Xixiang, Bao'an District, Shenzhen, Guangdong, China

Tel: +86-755 2523 4088

E-mail: agc@agc-cert.com

Service Hotline:400 089 2118

Conducted Power of LTE Band 41(dBm)

Bandwidth	Modulation	RB size	RB offset	Target MPR	Channel	Channel	Channel		
					39675	40620	41565		
5MHz	QPSK	1	0	0	22.12	23.24	22.39		
			12	0	22.24	23.34	22.62		
			24	0	22.20	23.19	22.72		
		12	0	1	21.14	23.19	21.61		
			6	1	21.16	23.21	21.64		
			11	1	21.16	23.16	21.65		
		25	0	1	21.15	23.21	21.60		
		16QAM	1	0	1	21.07	23.45	21.41	
				12	1	21.20	23.44	21.62	
	24			1	21.15	23.38	21.67		
	12		0	2	21.14	23.22	21.63		
			6	2	21.15	23.20	21.63		
			11	2	21.15	23.22	21.64		
	25		0	2	20.21	22.13	20.61		
	Bandwidth		Modulation	RB size	RB offset	Target MPR	Channel	Channel	Channel
							39700	40620	41540
	10MHz	QPSK	1	0	0	22.21	23.24	22.24	
				24	0	22.59	23.61	22.74	
49				0	22.40	23.18	22.77		
25			0	1	21.22	23.26	21.44		
			12	1	21.22	23.27	21.45		
			25	1	21.34	23.23	21.64		
50			0	1	21.28	23.28	21.54		
16QAM			1	0	1	21.35	23.30	21.36	
				24	1	21.67	23.66	21.82	
		49		1	21.55	23.22	21.85		
		25	0	2	21.24	23.26	21.46		
			12	2	21.23	23.25	21.47		
			25	2	21.37	23.24	21.65		
		50	0	2	20.31	22.26	20.51		



Attestation of Global Compliance(Shenzhen)Co.,Ltd.

Add: 2/F., Building 2, No.1-4, Chaxi Sanwei Technial Industrial Park, Gushu, Xixiang, Bao'an District, Shenzhen, Guangdong, China

Tel: +86-755 2523 4088 E-mail: agc@agc-cert.com Service Hotline:400 089 2118

Conducted Power of LTE Band 41(dBm)							
Bandwidth	Modulation	RB size	RB offset	Target MPR	Channel	Channel	Channel
					39725	40620	41515
15MHz	QPSK	1	0	0	22.19	23.10	22.07
			37	0	22.36	23.36	22.39
			74	0	22.54	23.90	22.67
		37	0	1	21.36	23.21	21.60
			16	1	21.39	23.22	21.59
			35	1	21.40	23.20	21.57
	75	0	1	21.38	23.21	21.59	
	16QAM	1	0	1	21.28	23.25	21.19
			37	1	21.50	23.51	21.50
			74	1	21.65	23.11	21.74
		37	0	2	21.39	23.21	21.59
			16	2	21.39	23.21	21.59
			35	2	21.40	23.22	21.59
	75	0	2	20.33	22.18	20.41	
Bandwidth	Modulation	RB size	RB offset	Target MPR	Channel	Channel	Channel
					39750	40620	41490
20MHz	QPSK	1	0	0	22.89	23.83	23.58
			49	0	22.68	23.59	23.21
			99	0	22.59	23.67	23.19
		50	0	1	21.28	23.13	21.91
			25	1	21.28	23.12	21.87
			49	1	21.60	23.06	22.09
	100	0	1	21.43	23.07	21.97	
	16QAM	1	0	1	20.98	23.02	21.53
			49	1	21.67	23.75	22.06
			99	1	21.59	22.82	22.11
		50	0	2	20.27	22.04	20.87
			25	2	20.28	22.01	20.91
			49	2	20.61	22.09	21.14
	100	0	2	20.44	22.09	20.95	



Attestation of Global Compliance(Shenzhen)Co.,Ltd.

Add: 2/F., Building 2, No.1-4, Chaxi Sanwei Technial Industrial Park, Gushu, Xixiang, Bao'an District, Shenzhen, Guangdong, China

Tel: +86-755 2523 4088

E-mail: agc@agc-cert.com

Service Hotline:400 089 2118

The following tests were conducted according to the test requirements outlined in section 6.2 of the 3GPP TS36.101 specification.

UE Power Class: 3 (23 +/- 2dBm). The allowed Maximum Power Reduction (MPR) for the maximum output power due to higher order modulation and transmit bandwidth configuration (resource blocks) is specified in Table 6.2.3.3-1 of the 3GPP TS36.101.

Table 6.2.3.3-1 Maximum Power Reduction (MPR) for Power class3

Modulation	Maximum Power Reduction (MPR) for Power[RB]						MPR(dB)
	1.4MHz	3MHz	5MHz	10MHz	15MHz	20MHz	
QPSK	>5	>4	>8	>12	>16	>18	≤1
16QAM	≤5	≤4	≤8	≤12	≤16	≤18	≤1
16QAM	>5	>4	>8	>12	>16	>18	≤2

The allowed A-MPR values specified below in Table 6.2.4.3-1 of 3GPP TS36.101 are in addition to the allowed MPR requirements. All the measurements below were performed with A-MPR disabled, by using Network Signaling Value of "NS_01".3



Attestation of Global Compliance(Shenzhen)Co.,Ltd.

Add: 2/F., Building 2, No.1-4, Chaxi Sanwei Technial Industrial Park, Gushu,
Xixiang, Bao'an District, Shenzhen, Guangdong, China

Tel: +86-755 2523 4088

E-mail: agc@agc-cert.com

Service Hotline:400 089 2118

Table 6.2.4.3-1: Additional Maximum Power Reduction (A-MPR) / Spectrum Emission requirements

Network Signaling value	Requirements (sub-clause)	E-UTRA Band	Channel bandwidth (MHz)	Resources Blocks (N_{RB})	A-MPR (dB)
NS_01	6.6.2.1.1	Table 5.2-1	1.4,3,5,10,15,20	Table 5.4.2-1	N/A
NS_03	6.6.2.2.3.1	2,4,10, 23, 25,35,36	3	>5	≤ 1
			5	>6	≤ 1
			10	>6	≤ 1
			15	>8	≤ 1
			20	>10	≤ 1
NS_04	6.6.2.2.3.2	41	5	>6	≤ 1
			10, 15, 20	Table 6.2.4.3-4	
NS_05	6.6.3.3.3.1	1	10,15,20	≥ 50	≤ 1
NS_06	6.6.2.2.3.3	12, 13, 14, 17	1.4, 3, 5, 10	Table 5.4.2-1	N/A
NS_07	6.6.2.2.3.3 6.6.3.3.3.2	13	10	Table 6.2.4.3-2	Table 6.2.4.3-2
NS_08	6.6.3.3.3.3	19	10, 15	> 44	≤ 3
NS_09	6.6.3.3.3.4	21	10, 15	> 40	≤ 1
				> 55	≤ 2
				Table 6.2.4.3-3	
NS_10		20	15, 20	Table 6.2.4.3-3	Table 6.2.4.3-3
NS_11	6.6.2.2.1 6.6.3.3.13	231	1.4, 3, 5, 10,15,20	Table 6.2.4.3-5	Table 6.2.4.3-5
NS_12	6.6.3.3.5	26	1.4, 3, 5	Table 6.2.4.3-6	Table 6.2.4.3-6
NS_13	6.6.3.3.6	26	5	Table 6.2.4.3-7	Table 6.2.4.3-7
NS_14	6.6.3.3.7	26	10, 15	Table 6.2.4.3-8	Table 6.2.4.3-8
NS_15	6.6.3.3.8	26	1.4, 3, 5, 10, 15	Table 6.2.4.3-9 Table 6.2.4.3-10	Table 6.2.4.3-9, Table 6.2.4.3-10
NS_16	6.6.3.3.9	27	3, 5, 10	Table 6.2.4.3-11, Table 6.2.4.3-12, Table 6.2.4.3-13	
NS_17	6.6.3.3.10	28	5, 10	Table 5.4.2-1	N/A
	6.6.3.3.11	28	5	≥ 2	≤ 1
NS_18			10, 15, 20	≥ 1	≤ 4
NS_19			10, 15, 20	Table 6.2.4.3-15	Table 6.2.4.3-15
NS_20			5, 10, 15, 20	Table 6.2.4.3-14	Table 6.2.4.3-14
...					
NS_20	-	-	-	-	-



Attestation of Global Compliance(Shenzhen)Co.,Ltd.

Add: 2/F., Building 2, No.1-4, Chaxi Sanwei Technial Industrial Park, Gushu, Xixiang, Bao'an District, Shenzhen, Guangdong, China

Tel: +86-755 2523 4088

E-mail: agc@agc-cert.com

Service Hotline:400 089 2118

WIFI

Mode	Data Rate (Mbps)	Channel	Frequency(MHz)	Avg. Burst Power(dBm)
802.11b	1	01	2412	14.03
		06	2437	13.64
		11	2462	14.34
802.11g	6	01	2412	10.08
		06	2437	12.41
		11	2462	10.19
802.11n(20)	6.5	01	2412	10.21
		06	2437	11.84
		11	2462	10.17
802.11n(40)	13.5	03	2422	11.22
		06	2437	10.14
		09	2452	11.96

Bluetooth_V4.2 (BR/EDR)

Modulation	Channel	Frequency(MHz)	Peak Power (dBm)
GFSK	0	2402	1.554
	39	2441	0.872
	78	2480	1.554
π /4-DQPSK	0	2402	0.352
	39	2441	-0.522
	78	2480	-0.071
8-DPSK	0	2402	0.436
	39	2441	-0.520
	78	2480	-0.065

Bluetooth_V4.2 (BLE)

Modulation	Channel	Frequency(MHz)	Peak Power (dBm)
GFSK	0	2402	1.655
	19	2440	0.301
	39	2480	1.704



Attestation of Global Compliance(Shenzhen)Co.,Ltd.

Add: 2/F., Building 2, No.1-4, Chaxi Sanwei Technial Industrial Park, Gushu, Xixiang, Bao'an District, Shenzhen, Guangdong, China

Tel: +86-755 2523 4088 E-mail: agc@agc-cert.com Service Hotline:400 089 2118

13. TEST RESULTS

13.1. SAR Test Results Summary

13.1.1. Test position and configuration

Body-worn SAR was performed with the device 5mm from the phantom, and 4 Edges SAR was performed with the device 5mm from the phantom.

13.1.2. Operation Mode

1. Per KDB 447498 D01 v06 ,for each exposure position, if the highest 1-g SAR is ≤ 0.8 W/kg, testing for low and high channel is optional.
2. Per KDB 865664 D01 v01r04,for each frequency band, if the measured SAR is ≥ 0.8 W/Kg, testing for repeated SAR measurement is required , that the highest measured SAR is only to be tested. When the SAR results are near the limit, the following procedures are required for each device to verify these types of SAR measurement related variation concerns by repeating the highest measured SAR configuration in each frequency band.
 - (1) When the original highest measured SAR is ≥ 0.8 W/Kg, repeat that measurement once.
 - (2) Perform a second repeated measurement only if the ratio of largest to smallest SAR for the original and first repeated measurements is >1.20 or when the original or repeated measurement is ≥ 1.45 W/Kg.
 - (3) Perform a third repeated measurement only if the original, first and second repeated measurement is ≥ 1.5 W/Kg and ratio of largest to smallest SAR for the original, first and second measurement is ≥ 1.20 .
3. Body-worn exposure conditions are intended to voice call operations, therefore GSM voice call mode is selected to be test.
4. Per KDB 648474 D04 v01r03,when the reported SAR for a body-worn accessory measured without a headset connected to the handset is ≤ 1.2 W/Kg, SAR testing with a headset connected is not required.
5. Per KDB 248227 D01v02r02,for 2.4GHz 802.11g/n SAR testing is not required when the highest reported SAR for DSSS is adjusted by the ratio of OFDM to DSSS specified maximum output power and the adjusted SAR is ≤ 1.2 W/kg.
6. Per KDB 941225 D06 V02r01, When the same wireless mode transmission configurations for voice and data are required for SAR measurements, the more conservative configuration with a smaller separation distance should be tested for the overlapping SAR configurations.
7. Maximum Scaling SAR in order to calculate the Maximum SAR values to test under the standard Peak Power, Calculation method is as follows:
Maximum Scaling SAR =tested SAR (Max.) \times [maximum turn-up power (mw)/ maximum measurement output power(mw)]
8. Proximity sensor, just for avoiding the wrong operation in the phone screen when call, and has no influence on output power or SAR result
9. Per KDB 941225 D05v02r03, start with the largest channel bandwidth and measure SAR for QPSK with 1RB allocation using the RB offset and required test channel combination with highest maximum output power for RB offsets at the upper edge, middle and lower edge of each required test channel.
10. Per KDB 941125 D05v02r03, 50% RB allocation for QPSK SAR testing follows 1RB QPSK allocation procedure.
11. Per KDB 941125 D05v02r03. For QPSK with 100% RB allocation. SAR is not required when the highest maximum output power for 100% RB allocation is less than the highest maximum output power in 50% and



1RB allocation and the highest reported SAR is >1.45 W/Kg, the remaining required test channels must also be tested.

12. Per KDB 941125 D05v02r03. 16QAM output power for each RB allocation configuration is not 1/2 dB higher than the same configuration in QPSK and the reported SAR for the QPSK configuration is ≤ 1.45 W/Kg, Per KDB 941225 D05v02r02, 16QAM SAR testing is not required.
13. Per KDB 941125 D05v02r03. Smaller bandwidth output power for each RB allocation configuration is $>$ not 1/2 dB higher than the same configuration in the largest supported bandwidth, and the reported SAR for the largest supported bandwidth is ≤ 1.45 W/Kg. Per KDB 941125 D05v02r03, smaller bandwidth SAR testing is not required.



Attestation of Global Compliance(Shenzhen)Co.,Ltd.

Add: 2/F., Building 2, No.1-4, Chaxi Sanwei Technial Industrial Park, Gushu,
Xixiang, Bao'an District, Shenzhen, Guangdong, China

Tel: +86-755 2523 4088

E-mail: agc@agc-cert.com

Service Hotline:400 089 2118

13.1.3. Test Result

SAR MEASUREMENT									
Depth of Liquid (cm):>15					Relative Humidity (%): 48.2				
Product: Portable Translator									
Test Mode: GSM850 with GMSK modulation									
Position	Mode	Ch.	Fr. (MHz)	Power Drift (<±5%)	SAR (1g) (W/kg)	Max. Tune-up Power (dBm)	Meas. output Power (dBm)	Scaled SAR (W/Kg)	Limit (W/kg)
SIM 1 Card									
Body back	GPRS-3 slot	190	836.6	-0.26	0.619	27.70	27.60	0.633	1.6
Body front	GPRS-3 slot	190	836.6	-0.35	0.430	27.70	27.60	0.440	1.6
Edge 2(Right)	GPRS-3 slot	190	836.6	-0.05	0.282	27.70	27.60	0.289	1.6
Edge 3(Bottom)	GPRS-3 slot	190	836.6	-0.17	0.153	27.70	27.60	0.157	1.6
Edge 4(Left)	GPRS-3 slot	190	836.6	0.01	0.443	27.70	27.60	0.453	1.6

Note:

- When the 1-g Reported SAR is ≤ 0.8 W/kg, testing for low and high channel is optional. Refer to KDB 447498.
- The test separation for body back, body front and 4 Edges is 5mm of all above table.



Attestation of Global Compliance(Shenzhen)Co.,Ltd.

Add: 2/F., Building 2, No.1-4, Chaxi Sanwei Technial Industrial Park, Gushu, Xixiang, Bao'an District, Shenzhen, Guangdong, China

Tel: +86-755 2523 4088

E-mail: agc@agc-cert.com

Service Hotline:400 089 2118

SAR MEASUREMENT									
Depth of Liquid (cm):>15					Relative Humidity (%): 48.2				
Product: Portable Translator									
Test Mode: PCS1900 with GMSK modulation									
Position	Mode	Ch.	Fr. (MHz)	Power Drift (<±5%)	SAR (1g) (W/kg)	Max. Tune-up Power (dBm)	Meas. output Power (dBm)	Scaled SAR (W/Kg)	Limit (W/kg)
SIM 1 Card									
Body back	GPRS-3 slot	512	1850.2	-1.36	1.177	25.70	25.12	1.345	1.6
Body back	GPRS-3 slot	661	1880	-0.68	1.391	25.70	25.60	1.423	1.6
Body back	GPRS-3 slot	810	1909.8	1.27	1.339	25.70	25.69	1.342	1.6
Body front	GPRS-3 slot	512	1850.2	0.42	0.764	25.70	25.12	0.873	1.6
Body front	GPRS-3 slot	661	1880	-0.16	0.898	25.70	25.60	0.919	1.6
Body front	GPRS-3 slot	810	1909.8	0.33	0.870	25.70	25.69	0.872	1.6
Body back+Ear.	GPRS-3 slot	512	1850.2	-1.20	1.249	25.70	25.12	1.427	1.6
Body back+Ear.	GPRS-3 slot	661	1880	-0.05	1.111	25.70	25.60	1.137	1.6
Body back+Ear.	GPRS-3 slot	810	1909.8	0.22	1.253	25.70	25.69	1.256	1.6
Edge 2(Right)	GPRS-3 slot	661	1880.0	0.56	0.303	25.70	25.60	0.310	1.6
Edge 3(Bottom)	GPRS-3 slot	512	1850.2	-0.07	0.755	25.70	25.12	0.863	1.6
Edge 3(Bottom)	GPRS-3 slot	661	1880	-0.21	0.882	25.70	25.60	0.903	1.6
Edge 3(Bottom)	GPRS-3 slot	810	1909.8	1.31	0.789	25.70	25.69	0.791	1.6
Edge 4(Left)	GPRS-3 slot	661	1880.0	0.08	0.591	25.70	25.60	0.605	1.6

Note:

- When the 1-g Reported SAR is ≤ 0.8 W/kg, testing for low and high channel is optional. Refer to KDB 447498.
- The test separation for body back, body front and 4 Edges is 5mm of all above table.



Attestation of Global Compliance(Shenzhen)Co.,Ltd.

Add: 2/F., Building 2, No.1-4, Chaxi Sanwei Technical Industrial Park, Gushu, Xixiang, Bao'an District, Shenzhen, Guangdong, China

Tel: +86-755 2523 4088

E-mail: agc@agc-cert.com

Service Hotline:400 089 2118

SAR MEASUREMENT									
Depth of Liquid (cm):>15					Relative Humidity (%): 48.2				
Product: Portable Translator									
Test Mode: WCDMA Band II with QPSK modulation									
Position	Mode	Ch.	Fr. (MHz)	Power Drift ($\leq \pm 5\%$)	SAR (1g) (W/kg)	Max. Tune-up Power (dBm)	Meas. output Power (dBm)	Scaled SAR (W/Kg)	Limit (W/kg)
Body back	RMC 12.2kbps	9262	1852.4	-0.39	1.259	22.90	22.17	1.489	1.6
Body back	RMC 12.2kbps	9400	1880	-0.22	1.268	22.90	22.90	1.268	1.6
Body back	RMC 12.2kbps	9538	1907.6	1.07	1.133	22.90	22.19	1.334	1.6
Body front	RMC 12.2kbps	9400	1880	-0.16	0.506	22.90	22.90	0.506	1.6
Body back+Ear.	RMC 12.2kbps	9262	1852.4	0.53	1.222	22.90	22.17	1.446	1.6
Body back+Ear.	RMC 12.2kbps	9400	1880	-1.24	1.200	22.90	22.90	1.200	1.6
Body back+Ear.	RMC 12.2kbps	9538	1907.6	-1.11	1.126	22.90	22.19	1.326	1.6
Edge 2(Right)	RMC 12.2kbps	9400	1880	0.58	0.247	22.90	22.90	0.247	1.6
Edge 3(Bottom)	RMC 12.2kbps	9400	1880	-0.27	0.721	22.90	22.90	0.721	1.6
Edge 4(Left)	RMC 12.2kbps	9400	1880	-0.52	0.446	22.90	22.90	0.446	1.6

Note:

- When the 1-g Reported SAR is ≤ 0.8 W/kg, testing for low and high channel is optional. Refer to KDB 447498.
- The test separation for body back, body front and 4 Edges is 5mm of all above table.



Attestation of Global Compliance(Shenzhen)Co.,Ltd.

Add: 2/F., Building 2, No.1-4, Chaxi Sanwei Technial Industrial Park, Gushu, Xixiang, Bao'an District, Shenzhen, Guangdong, China

Tel: +86-755 2523 4088

E-mail: agc@agc-cert.com

Service Hotline:400 089 2118

SAR MEASUREMENT									
Depth of Liquid (cm):>15					Relative Humidity (%): 48.2				
Product: Portable Translator									
Test Mode: WCDMA Band V with QPSK modulation									
Position	Mode	Ch.	Fr. (MHz)	Power Drift ($\pm 5\%$)	SAR (1g) (W/kg)	Max. Tune-up Power (dBm)	Meas. output Power (dBm)	Scaled SAR (W/Kg)	Limit (W/kg)
Body back	RMC 12.2kbps	4183	836.6	-0.39	0.475	23.60	23.58	0.477	1.6
Body front	RMC 12.2kbps	4183	836.6	-0.26	0.417	23.60	23.58	0.419	1.6
Edge 2(Right)	RMC 12.2kbps	4183	836.6	-0.57	0.244	23.60	23.58	0.245	1.6
Edge 3(Bottom)	RMC 12.2kbps	4183	836.6	0.13	0.119	23.60	23.58	0.120	1.6
Edge 4(Left)	RMC 12.2kbps	4183	836.6	0.05	0.421	23.60	23.58	0.423	1.6

Note:

- When the 1-g Reported SAR is ≤ 0.8 W/kg, testing for low and high channel is optional. Refer to KDB 447498.
- The test separation for body back, body front and 4 Edges is 5mm of all above table.



Attestation of Global Compliance(Shenzhen)Co.,Ltd.

Add: 2/F., Building 2, No.1-4, Chaxi Sanwei Technial Industrial Park, Gushu, Xixiang, Bao'an District, Shenzhen, Guangdong, China

Tel: +86-755 2523 4088

E-mail: agc@agc-cert.com

Service Hotline:400 089 2118

SAR MEASUREMENT												
Depth of Liquid (cm):>15						Relative Humidity (%):49.5						
Product: Portable Translator												
Test Mode: LTE Band 2												
BM MHz	MOD	Position	Test Mode		Ch.	Freq. (MHz)	Power Drift (<±5%)	SAR (1g) (W/kg)	Max. Tune up Power (dBm)	Meas. output Power (dBm)	Scaled SAR (W/Kg)	Limit (W/kg)
			UL RB Allocation	UL RB START								
20	QPSK	Body back	1	0	18700	1860	-0.33	1.255	24.03	23.29	1.488	1.6
		Body back	1	0	18900	1880	-0.27	1.163	24.03	23.10	1.441	1.6
		Body back	1	0	19100	1900	-0.18	1.111	24.03	22.75	1.492	1.6
		Body front	1	0	18700	1860	1.56	0.647	24.03	23.29	0.767	1.6
		Body front	1	0	18900	1880	0.28	0.755	24.03	23.10	0.935	1.6
		Body front	1	0	19100	1900	0.19	0.582	24.03	22.75	0.781	1.6
		Body back+ Ear.	1	0	18700	1860	0.62	1.000	24.03	23.29	1.186	1.6
		Body back+ Ear.	1	0	18900	1880	1.35	1.000	24.03	23.10	1.239	1.6
		Body back+ Ear.	1	0	19100	1900	-0.24	1.107	24.03	22.75	1.486	1.6
		Edge 2(Right)	1	0	18900	1880	-0.15	0.195	24.03	23.10	0.242	1.6
		Edge 3(Bottom)	1	0	18900	1880	-0.08	0.519	24.03	23.10	0.643	1.6
		Edge 4(Left)	1	0	18900	1880	0.22	0.418	24.03	23.10	0.518	1.6

Note:

- When the 1-g Reported SAR is ≤ 0.8 W/kg, testing for low and high channel is optional. Refer to KDB 447498.
- The test separation for body back, body front and 4 Edges is 5mm of all above table.



Attestation of Global Compliance(Shenzhen)Co.,Ltd.

Add: 2/F., Building 2, No.1-4, Chaxi Sanwei Technial Industrial Park, Gushu, Xixiang, Bao'an District, Shenzhen, Guangdong, China

Tel: +86-755 2523 4088

E-mail: agc@agc-cert.com

Service Hotline:400 089 2118

SAR MEASUREMENT												
Depth of Liquid (cm):>15						Relative Humidity (%): 49.5						
Product: Portable Translator												
Test Mode: LTE Band 5												
BM MHz	MOD	Position	Test Mode		Ch.	Freq. (MHz)	Power Drift ($\leq \pm 5\%$)	SAR (1g) (W/kg)	Max. Tuneup Power (dBm)	Meas. output Power (dBm)	Scaled SAR (W/Kg)	Limit (W/kg)
			UL RB Allocation	UL RB START								
10	QPSK	Body back	1	0	20525	836.5	-0.61	0.486	24.50	23.40	0.626	1.6
		Body front	1	0	20525	836.5	-0.28	0.375	24.50	23.40	0.483	1.6
		Edge 2(Right)	1	0	20525	836.5	0.24	0.220	24.50	23.40	0.283	1.6
		Edge 3(Bottom)	1	0	20525	836.5	-0.17	0.098	24.50	23.40	0.126	1.6
		Edge 4(Left)	1	0	20525	836.5	0.06	0.445	24.50	23.40	0.573	1.6

Note:

- When the 1-g Reported SAR is ≤ 0.8 W/kg, testing for low and high channel is optional. Refer to KDB 447498.
- The test separation for body back, body front and 4 Edges is 5mm of all above table.



Attestation of Global Compliance(Shenzhen)Co.,Ltd.

Add: 2/F., Building 2, No.1-4, Chaxi Sanwei Technial Industrial Park, Gushu, Xixiang, Bao'an District, Shenzhen, Guangdong, China

Tel: +86-755 2523 4088

E-mail: agc@agc-cert.com

Service Hotline:400 089 2118

SAR MEASUREMENT												
Depth of Liquid (cm):>15						Relative Humidity (%):47.3						
Product: Portable Translator												
Test Mode: LTE Band 7												
BM MHz	MOD	Position	Test Mode		Ch.	Freq. (MHz)	Power Drift ($\pm 5\%$)	SAR (1g) (W/kg)	Max. Tuneup Power (dBm)	Meas. output Power (dBm)	Scaled SAR (W/Kg)	Limit (W/kg)
			UL RB Allocation	UL RB START								
20	QPSK	Body back	1	0	20850	2510	-0.39	1.162	23.59	23.59	1.162	1.6
		Body back	1	0	21100	2535	0.22	1.155	23.59	22.78	1.392	1.6
		Body back	1	0	21350	2560	-0.15	1.145	23.59	22.82	1.367	1.6
		Body front	1	0	21100	2535	-0.27	0.015	23.59	22.78	0.018	1.6
		Body back+Ear.	1	0	20850	2510	0.46	1.156	23.59	23.59	1.156	1.6
		Body back+Ear.	1	0	21100	2535	-1.33	0.972	23.59	22.78	1.171	1.6
		Body back+Ear.	1	0	21350	2560	-1.27	0.970	23.59	22.82	1.158	1.6
		Edge 2(Right)	1	0	21100	2535	-0.25	0.009	23.59	22.78	0.011	1.6
		Edge 3(Bottom)	1	0	21100	2535	-0.22	0.171	23.59	22.78	0.206	1.6
		Edge 4(Left)	1	0	21100	2535	0.36	0.064	23.59	22.78	0.077	1.6

Note:

- When the 1-g Reported SAR is ≤ 0.8 W/kg, testing for low and high channel is optional. Refer to KDB 447498.
- The test separation for body back, body front and 4 Edges is 5mm of all above table.



Attestation of Global Compliance(Shenzhen)Co.,Ltd.

Add: 2/F., Building 2, No.1-4, Chaxi Sanwei Technial Industrial Park, Gushu, Xixiang, Bao'an District, Shenzhen, Guangdong, China

Tel: +86-755 2523 4088

E-mail: agc@agc-cert.com

Service Hotline:400 089 2118

SAR MEASUREMENT												
Depth of Liquid (cm):>15						Relative Humidity (%): 47.3						
Product: Portable Translator												
Test Mode: LTE Band 12												
BM MHz	MOD	Position	Test Mode		Ch.	Freq. (MHz)	Power Drift ($\pm 5\%$)	SAR (1g) (W/kg)	Max. Tuneup Power (dBm)	Meas. output Power (dBm)	Scaled SAR (W/Kg)	Limit (W/kg)
			UL RB Allocation	UL RB START								
10	QPSK	Body back	1	0	23095	707.5	-0.29	0.178	24.50	24.31	0.186	1.6
		Body front	1	0	23095	707.5	0.28	0.014	24.50	24.31	0.015	1.6
		Edge 2(Right)	1	0	23095	707.5	-0.24	0.007	24.50	24.31	0.007	1.6
		Edge 3(Bottom)	1	0	23095	707.5	-0.15	0.008	24.50	24.31	0.008	1.6
		Edge 4(Left)	1	0	23095	707.5	0.06	0.016	24.50	24.31	0.017	1.6

Note:

- When the 1-g Reported SAR is ≤ 0.8 W/kg, testing for low and high channel is optional. Refer to KDB 447498.
- The test separation for body back, body front and 4 Edges is 5mm of all above table.



Attestation of Global Compliance(Shenzhen)Co.,Ltd.

Add: 2/F., Building 2, No.1-4, Chaxi Sanwei Technial Industrial Park, Gushu, Xixiang, Bao'an District, Shenzhen, Guangdong, China

Tel: +86-755 2523 4088

E-mail: agc@agc-cert.com

Service Hotline:400 089 2118

SAR MEASUREMENT												
Depth of Liquid (cm):>15						Relative Humidity (%): 47.3						
Product: Portable Translator												
Test Mode: LTE Band 17												
BM MHz	MOD	Position	Test Mode		Ch.	Freq. (MHz)	Power Drift ($\leq\pm 5\%$)	SAR (1g) (W/kg)	Max. Tuneup Power (dBm)	Meas. output Power (dBm)	Scaled SAR (W/Kg)	Limit (W/kg)
			UL RB Allocation	UL RB START								
10	QPSK	Body back	1	0	23790	710	-0.66	0.600	23.60	23.45	0.621	1.6
		Body front	1	0	23790	710	0.28	0.342	23.60	23.45	0.354	1.6
		Edge 2(Right)	1	0	23790	710	0.34	0.333	23.60	23.45	0.345	1.6
		Edge 3(Bottom)	1	0	23790	710	-0.42	0.283	23.60	23.45	0.293	1.6
		Edge 4(Left)	1	0	23790	710	0.27	0.433	23.60	23.45	0.448	1.6

Note:

- When the 1-g Reported SAR is ≤ 0.8 W/kg, testing for low and high channel is optional. Refer to KDB 447498.
- The test separation for body back, body front and 4 Edges is 5mm of all above table.



Attestation of Global Compliance(Shenzhen)Co.,Ltd.

Add: 2/F., Building 2, No.1-4, Chaxi Sanwei Technial Industrial Park, Gushu, Xixiang, Bao'an District, Shenzhen, Guangdong, China

Tel: +86-755 2523 4088

E-mail: agc@agc-cert.com

Service Hotline:400 089 2118

SAR MEASUREMENT												
Depth of Liquid (cm):>15						Relative Humidity (%): 43.4						
Product: Portable Translator												
Test Mode: LTE Band 40												
BW MHz	MOD	Position	Test Mode		Ch.	Freq. (MHz)	Power Drift ($\leq \pm 5\%$)	SAR (1g) (W/kg)	Max. Tune-up Power (dBm)	Meas. output Power (dBm)	Scaled SAR (W/Kg)	Limit (W/kg)
			UL RB Allocation	UL RB START								
20	QPSK	Body back	1	0	39150	2350	-0.29	0.115	23.80	21.89	0.179	1.6
		Body front	1	0	39150	2350	-0.05	0.009	23.80	21.89	0.014	1.6
		Edge 2(Right)	1	0	39150	2350	-0.46	0.009	23.80	21.89	0.014	1.6
		Edge 3(Bottom)	1	0	39150	2350	0.11	0.026	23.80	21.89	0.040	1.6
		Edge 4(Left)	1	0	39150	2350	0.05	0.010	23.80	21.89	0.016	1.6

Note:

- When the 1-g Reported SAR is ≤ 0.8 W/kg, testing for low and high channel is optional. Refer to KDB 447498.
- The test separation for body back, body front and 4 Edges is 5mm of all above table.



Attestation of Global Compliance(Shenzhen)Co.,Ltd.

Add: 2/F., Building 2, No.1-4, Chaxi Sanwei Technial Industrial Park, Gushu, Xixiang, Bao'an District, Shenzhen, Guangdong, China

Tel: +86-755 2523 4088

E-mail: agc@agc-cert.com

Service Hotline:400 089 2118

SAR MEASUREMENT												
Depth of Liquid (cm):>15						Relative Humidity (%): 47.3						
Product: Portable Translator												
Test Mode: LTE Band 41												
BW MHz	MOD	Position	Test Mode		Ch.	Freq. (MHz)	Power Drift ($\leq \pm 5\%$)	SAR (1g) (W/kg)	Max. Tuneup Power (dBm)	Meas. output Power (dBm)	Scaled SAR (W/Kg)	Limit (W/kg)
			UL RB Allocation	UL RB START								
20	QPSK	Body back	1	0	39750	2506	-0.28	1.186	23.90	22.89	1.497	1.6
		Body back	1	0	40620	2593	1.42	1.219	23.90	23.83	1.239	1.6
		Body back	1	0	41490	2680	0.16	1.189	23.90	23.58	1.280	1.6
		Body front	1	0	40620	2593	-0.35	0.034	23.90	23.83	0.035	1.6
		Body back+ Ear.	1	0	39750	2506	-0.29	1.173	23.90	22.89	1.480	1.6
		Body back+ Ear.	1	0	40620	2593	-1.02	1.174	23.90	23.83	1.193	1.6
		Body back+ Ear.	1	0	41490	2680	0.27	1.172	23.90	23.58	1.262	1.6
		Edge 2(Right)	1	0	40620	2593	-0.51	0.020	23.90	23.83	0.020	1.6
		Edge 3(Bottom)	1	0	40620	2593	0.23	0.262	23.90	23.83	0.266	1.6
		Edge 4(Left)	1	0	40620	2593	0.02	0.117	23.90	23.83	0.119	1.6

Note:

- When the 1-g Reported SAR is ≤ 0.8 W/kg, testing for low and high channel is optional. Refer to KDB 447498.
- The test separation for body back, body front and 4 Edges is 5mm of all above table



Attestation of Global Compliance(Shenzhen)Co.,Ltd.

Add: 2/F., Building 2, No.1-4, Chaxi Sanwei Technial Industrial Park, Gushu, Xixiang, Bao'an District, Shenzhen, Guangdong, China

Tel: +86-755 2523 4088

E-mail: agc@agc-cert.com

Service Hotline:400 089 2118

SAR MEASUREMENT									
Depth of Liquid (cm):>15					Relative Humidity (%): 49.2				
Product: Portable Translator									
Test Mode:802.11b									
Position	Mode	Ch.	Fr. (MHz)	Power Drift ($\pm 5\%$)	SAR (1g) (W/kg)	Max. Tune-up Power (dBm)	Meas. output Power (dBm)	Scaled SAR (W/Kg)	Limit (W/kg)
Body back	DTS	11	2462	-0.33	0.078	14.40	14.34	0.079	1.6
Body front	DTS	11	2462	-0.28	0.040	14.40	14.34	0.041	1.6
Edge 1 (Top)	DTS	11	2462	0.65	0.016	14.40	14.34	0.016	1.6
Edge 4(Left)	DTS	11	2462	0.20	0.038	14.40	14.34	0.039	1.6

Note:

- According to KDB248227, SAR is not required for 802.11n HT20/HT40 channels when the maximum average output power is less than 1/4 dB higher than that measured on the corresponding 802.11a/b channels.
- All of above "DTS" means data transmitters.
- The test separation for body back, body front and 4 Edges is 5mm of all above table.



Attestation of Global Compliance(Shenzhen)Co.,Ltd.

Add: 2/F., Building 2, No.1-4, Chaxi Sanwei Technical Industrial Park, Gushu, Xixiang, Bao'an District, Shenzhen, Guangdong, China

Tel: +86-755 2523 4088

E-mail: agc@agc-cert.com

Service Hotline:400 089 2118

Repeated SAR										
Product: Portable Translator										
Test Mode: PCS1900 with GMSK modulation & WCDMA Band II with QPSK modulation										
Position	Mode	Ch.	Fr. (MHz)	Power Drift (<±5%)	Once SAR (1g) (W/kg)	Power Drift (<±5%)	Twice SAR (1g) (W/kg)	Power Drift (<±5%)	Third SAR (1g) (W/kg)	Limit W/kg
Body back	GPRS-3 slot	661	1880	-0.21	1.268	--	--	--	--	1.6
Body back	RMC 12.2kbps	9400	1880	0.05	1.211	--	--	--	--	1.6

Repeated SAR											
Product: Portable Translator											
Test Mode: LTE Band 2& LTE Band 7& LTE Band 41 with QPSK modulation											
Position	Test Mode		Ch.	Fr. (MHz)	Power Drift (<±5%)	Once SAR (1g) (W/kg)	Power Drift (<±5%)	Twice SAR (1g) (W/kg)	Power Drift (<±5%)	Third SAR (1g) (W/kg)	Limit W/kg
	UL RB Allocation	UL RB START									
Body back	1	0	18700	1860	-0.31	1.122	--	--	--	--	1.6
Body back	1	0	20850	2510	0.05	0.971	--	--	--	--	1.6
Body back	1	0	40620	2593	-0.62	1.217	--	--	--	--	1.6



Attestation of Global Compliance(Shenzhen)Co.,Ltd.

Add: 2/F., Building 2, No.1-4, Chaxi Sanwei Technial Industrial Park, Gushu, Xixiang, Bao'an District, Shenzhen, Guangdong, China

Tel: +86-755 2523 4088

E-mail: agc@agc-cert.com

Service Hotline:400 089 2118