FCC Test Report

Report No.: AGC08506200603FE02

FCC ID : 2ATS9-1313
APPLICATION PURPOSE : Original Equipment
PRODUCT DESIGNATION : TRUE WIRELESS ACTIVE HEADPHONE
BRAND NAME : CLEER
MODEL NAME : GOAL
APPLICANT : CLEER LIMITED
DATE OF ISSUE : July 10, 2020
STANDARD(S) : FCC Part 15.247
REPORT VERSION : V1.0

Attestation of Global Compliance (Shenzhen) Co., Ltd

CAUTION:

This report shall not be reproduced except in full without the written permission of the test laboratory and shall not be quoted out of context.



REPORT REVISE RECORD

Report Version	Revise Time	Issued Date	Valid Version	Notes
V1.0	/	July 10, 2020	Valid	Initial Release



TABLE OF CONTENTS

1. VERIFICATION OF COMPLIANCE 5

2.GENERAL INFORMATION 6

 2.1 PRODUCT DESCRIPTION 6

 2.2. TABLE OF CARRIER FREQUENCIES 6

 2.3 RELATED SUBMITTAL(S)/GRANT(S) 7

 2.4 TEST METHODOLOGY 7

 2.5 SPECIAL ACCESSORIES 7

 2.6 EQUIPMENT MODIFICATIONS 7

3. MEASUREMENT UNCERTAINTY 8

4. DESCRIPTION OF TEST MODES 9

5. SYSTEM TEST CONFIGURATION 10

 5.1 CONFIGURATION OF TESTED SYSTEM 10

 5.2 EQUIPMENT USED IN TESTED SYSTEM 10

 5.3. SUMMARY OF TEST RESULTS 10

6. TEST FACILITY 11

7. PEAK OUTPUT POWER 12

 7.1. MEASUREMENT PROCEDURE 12

 7.2. TEST SET-UP (BLOCK DIAGRAM OF CONFIGURATION) 12

 7.3. LIMITS AND MEASUREMENT RESULT 13

8. 6 DB BANDWIDTH 15

 8.1. MEASUREMENT PROCEDURE 15

 8.2. TEST SET-UP (BLOCK DIAGRAM OF CONFIGURATION) 15

 8.3. LIMITS AND MEASUREMENT RESULTS 15

9. CONDUCTED SPURIOUS EMISSION 17

 9.1. MEASUREMENT PROCEDURE 17

 9.2. TEST SET-UP (BLOCK DIAGRAM OF CONFIGURATION) 17

 9.3. MEASUREMENT EQUIPMENT USED 17

 9.4. LIMITS AND MEASUREMENT RESULT 17

10. MAXIMUM CONDUCTED OUTPUT POWER SPECTRAL DENSITY 25



10.1 MEASUREMENT PROCEDURE	25
10.2 TEST SET-UP (BLOCK DIAGRAM OF CONFIGURATION)	25
10.3 MEASUREMENT EQUIPMENT USED	25
10.4 LIMITS AND MEASUREMENT RESULT	25
11. RADIATED EMISSION.....	27
11.1. MEASUREMENT PROCEDURE	27
11.2. TEST SETUP.....	28
11.3. LIMITS AND MEASUREMENT RESULT	29
11.4. TEST RESULT.....	29
14. FCC LINE CONDUCTED EMISSION TEST	39
14.1. LIMITS OF LINE CONDUCTED EMISSION TEST	39
14.2. BLOCK DIAGRAM OF LINE CONDUCTED EMISSION TEST.....	39
14.3. PRELIMINARY PROCEDURE OF LINE CONDUCTED EMISSION TEST.....	40
14.4. FINAL PROCEDURE OF LINE CONDUCTED EMISSION TEST.....	40
14.5. TEST RESULT OF LINE CONDUCTED EMISSION TEST	40
APPENDIX A: PHOTOGRAPHS OF TEST SETUP	41
APPENDIX B: PHOTOGRAPHS OF EUT	42



1. VERIFICATION OF COMPLIANCE

Applicant	CLEER LIMITED
Address	Units 3306-12, 33/F, Shui On Centre, Nos.6-8 Harbour Road, Wanchai, Hong Kong
Manufacturer	CLEER LIMITED
Address	Units 3306-12, 33/F, Shui On Centre, Nos.6-8 Harbour Road, Wanchai, Hong Kong
Factory	CLEER LIMITED
Address	Units 3306-12, 33/F, Shui On Centre, Nos.6-8 Harbour Road, Wanchai, Hong Kong
Product Designation	TRUE WIRELESS ACTIVE HEADPHONE
Brand Name	CLEER
Test Model	GOAL
Date of test	Jun. 17, 2020 to July 10, 2020
Deviation	No any deviation from the test method
Condition of Test Sample	Normal
Test Result	Pass
Report Template	AGCRT-US-BLE/RF

We hereby certify that:

The above equipment was tested by Attestation of Global Compliance (Shenzhen) Co., Ltd. The test data, data evaluation, test procedures, and equipment configurations shown in this report were made in accordance with the procedures given in ANSI C63.10 (2013) and the energy emitted by the sample EUT tested as described in this report is in compliance with radiated emission limits of FCC part 15.247.

Prepared By

NiNi Guo

NiNi Guo
Project Engineer

July 10, 2020

Reviewed By

Max Zhang

Max Zhang
Reviewer

July 10, 2020

Approved By

Forrest Lei

Forrest Lei
Authorized Officer

July 10, 2020



2.GENERAL INFORMATION

2.1PRODUCT DESCRIPTION

The EUT is designed as a “TRUE WIRELESS ACTIVE HEADPHONE”. It is designed by way of utilizing the GFSK technology to achieve the system operation.

A major technical description of EUT is described as following

Operation Frequency	2.402GHz to 2.480GHz
RF Output Power	0.180dBm(Max)
Bluetooth Version	V5.0
Modulation	BR <input checked="" type="checkbox"/> GFSK, EDR <input checked="" type="checkbox"/> π /4-DQPSK, <input checked="" type="checkbox"/> 8DPSK BLE <input checked="" type="checkbox"/> GFSK 1Mbps <input type="checkbox"/> GFSK 2Mbps
Number of Channels	40 Channel
Antenna Designation	FPC Antenna(Comply with requirements of the FCC part 15.203)
Antenna Gain	1.5dBi
Hardware Version	V1.2
Software Version	V1.0.3
Power Supply	DC 3.7V by battery
Note: The EUT comprises left and right channel headsets, both are the same in SCH but different in the PCB Layout. Both of them have been tested. Only the test data of right headset recorded in this report.	

2.2. TABLE OF CARRIER FREQUENCIES

Frequency Band	Channel Number	Frequency
2400~2483.5MHZ	0	2402MHZ
	1	2404MHZ
	:	:
	38	2478 MHZ
	39	2480 MHZ



2.3 RELATED SUBMITTAL(S)/GRANT(S)

This submittal(s) (test report) is intended for **FCC ID: 2ATS9-1313** filing to comply with the FCC Part 15.247 requirements.

2.4 TEST METHODOLOGY

Both conducted and radiated testing was performed according to the procedures in ANSI C63.10 (2013). Radiated testing was performed at an antenna to EUT distance 3 meters.

2.5 SPECIAL ACCESSORIES

Refer to section 2.2.

2.6 EQUIPMENT MODIFICATIONS

Not available for this EUT intended for grant.



3. MEASUREMENT UNCERTAINTY

The reported uncertainty of measurement $y \pm U$, where expanded uncertainty U is based on a standard uncertainty multiplied by a coverage factor of $k=2$, providing a level of confidence of approximately 95%.

- Uncertainty of Conducted Emission, $U_c = \pm 3.1$ dB
- Uncertainty of Radiated Emission below 1GHz, $U_c = \pm 4.0$ dB
- Uncertainty of Radiated Emission above 1GHz, $U_c = \pm 4.8$ dB
- Uncertainty of total RF power, conducted, $U_c = \pm 0.8$ dB
- Uncertainty of RF power density, conducted, $U_c = \pm 2.6$ dB
- Uncertainty of spurious emissions, conducted, $U_c = \pm 2.7$ dB
- Uncertainty of Occupied Channel Bandwidth: $U_c = \pm 2$ %



4. DESCRIPTION OF TEST MODES

NO.	TEST MODE DESCRIPTION
1	Low channel TX
2	Middle channel TX
3	High channel TX

Note:

1. Only the result of the worst case was recorded in the report, if no other cases.
2. For Radiated Emission, 3axis were chosen for testing for each applicable mode.
3. For Conducted Test method, a temporary antenna connector is provided by the manufacture.
4. The test software is the Blue Test3 which can set the EUT into the individual test modes.



5. SYSTEM TEST CONFIGURATION

5.1 CONFIGURATION OF TESTED SYSTEM

Radiated Emission Configure :



5.2 EQUIPMENT USED IN TESTED SYSTEM

Item	Equipment	Model No.	ID or Specification	Remark
1	TRUE WIRELESS ACTIVE HEADPHONE	GOAL	2ATS9-1313	EUT

5.3. SUMMARY OF TEST RESULTS

FCC RULES	DESCRIPTION OF TEST	RESULT
15.247 (b)(3)	Peak Output Power	Compliant
15.247 (a)(2)	6 dB Bandwidth	Compliant
15.247 (d)	Conducted Spurious Emission	Compliant
15.247 (e)	Maximum Conducted Output Power Density	Compliant
15.209	Radiated Emission	Compliant
15.207	Conducted Emission	N/A

Note: The EUT is powered by battery.



6. TEST FACILITY

Test Site	Attestation of Global Compliance (Shenzhen) Co., Ltd
Location	1-2/F, Building 19, Junfeng Industrial Park, Chongqing Road, Heping Community, Fuhai Street, Bao'an District, Shenzhen, Guangdong, China
Designation Number	CN1259
FCC Test Firm Registration Number	975832
A2LA Cert. No.	5054.02
Description	Attestation of Global Compliance(Shenzhen) Co., Ltd is accredited by A2LA

TEST EQUIPMENT OF RADIATED EMISSION TEST

Equipment	Manufacturer	Model	S/N	Cal. Date	Cal. Due
TEST RECEIVER	R&S	ESCI	10096	May 15, 2020	May 14, 2022
EXA Signal Analyzer	Aglient	N9010A	MY53470504	Dec. 12, 2019	Dec. 11, 2020
2.4GHz Fliter	EM Electronics	2400-2500MHz	N/A	Mar. 23, 2020	Mar. 22, 2022
Attenuator	ZHINAN	E-002	N/A	Sep. 09, 2019	Sep. 08, 2020
Horn antenna	SCHWARZBEC K	BBHA 9170	#768	Sep. 09, 2019	Sep. 08, 2021
Active loop antenna (9K-30MHz)	ZHINAN	ZN30900C	18051	May 22, 2020	May 21, 2022
Double-Ridged Waveguide Horn	ETS LINDGREN	3117	00034609	May 17, 2019	May 16, 2021
Broadband Preamplifier	ETS LINDGREN	3117PA	00225134	Oct. 15, 2019	Oct. 16, 2020
ANTENNA	SCHWARZBEC K	VULB9168	494	Sep. 20, 2019	Sep. 19, 2021
Test software	FARA	EZ-EMC (Ver RA-03A)	N/A	N/A	N/A



7. PEAK OUTPUT POWER

7.1. MEASUREMENT PROCEDURE

For peak power test:

1. Connect EUT RF output port to the Spectrum Analyzer through an RF attenuator
2. $RBW \geq DTS$ bandwidth
3. $VBW \geq 3 * RBW$.
4. $SPAN \geq VBW$.
5. Sweep: Auto.
6. Detector function: Peak.
7. Trace: Max hold.

Allow trace to stabilize. Use the marker-to-peak function to set the marker to the peak of the emission. The indicated level is the peak output power, after any corrections for external attenuators and cables.

7.2. TEST SET-UP (BLOCK DIAGRAM OF CONFIGURATION) PEAK POWER TEST SETUP

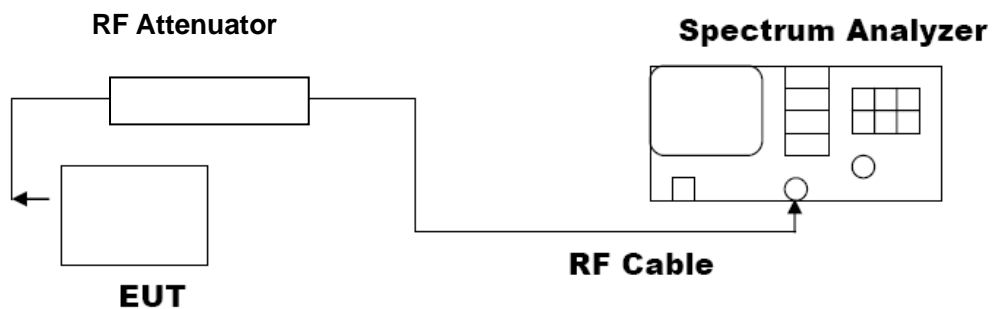

7.3. LIMITS AND MEASUREMENT RESULT

PEAK OUTPUT POWER MEASUREMENT RESULT FOR GFSK MODULATION			
Frequency (GHz)	Peak Power (dBm)	Applicable Limits (dBm)	Pass or Fail
2.402	-0.018	30	Pass
2.440	-0.008	30	Pass
2.480	0.180	30	Pass

CH0

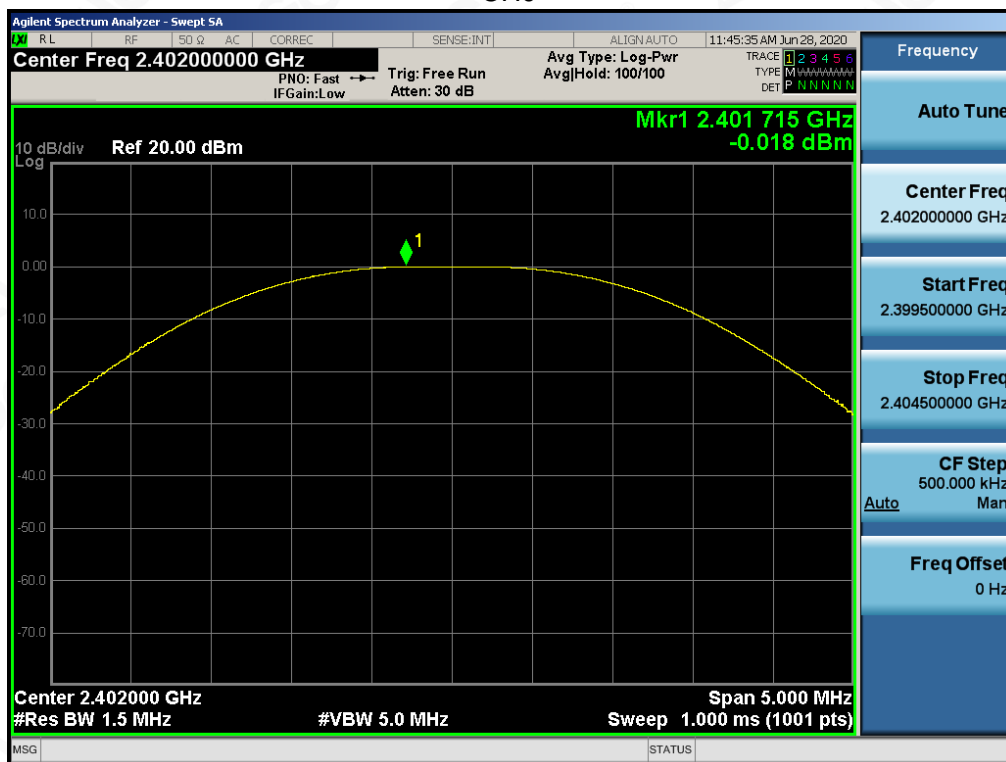

CH19

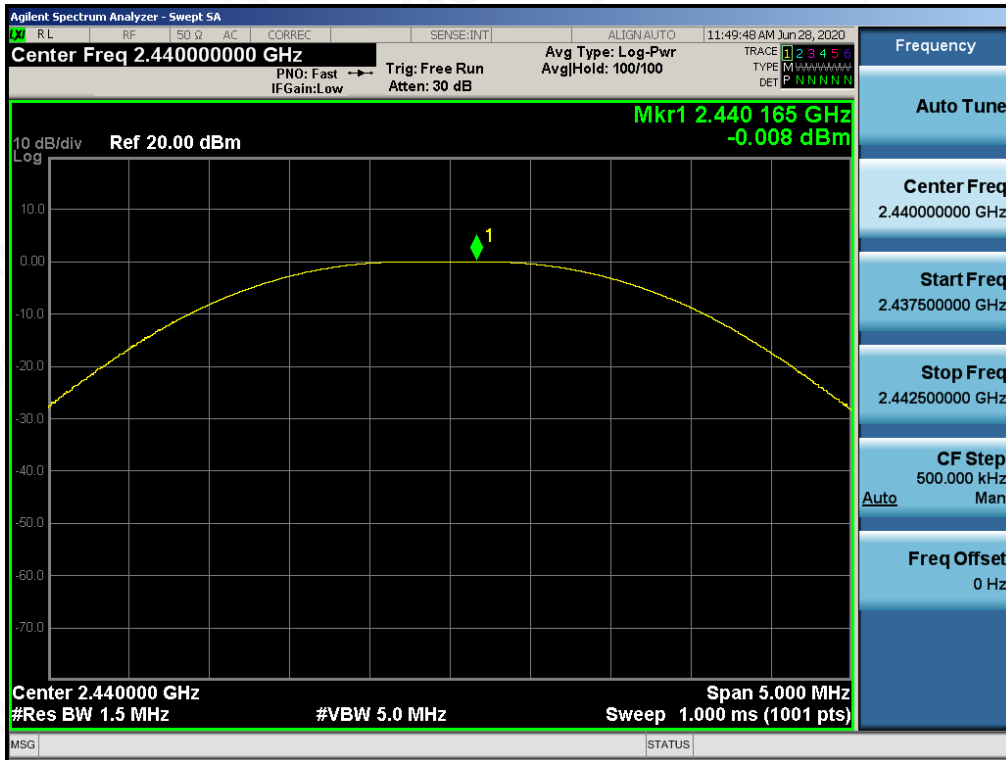

CH39

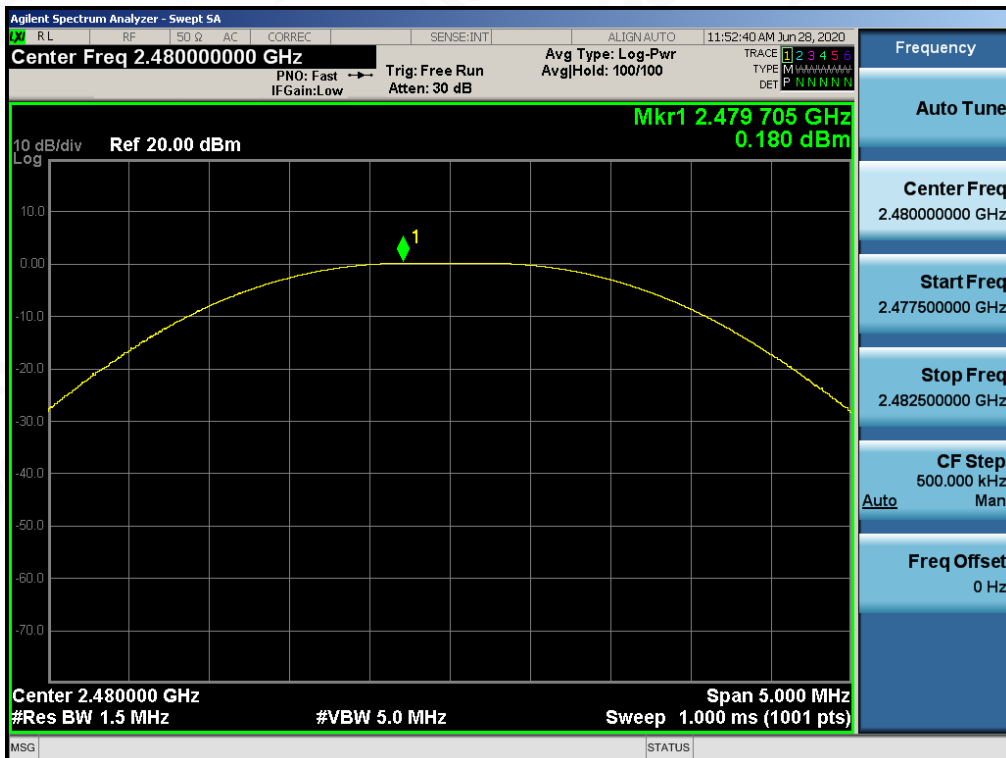

8. 6 DB BANDWIDTH

8.1. MEASUREMENT PROCEDURE

1. Connect EUT RF output port to the Spectrum Analyzer through an RF attenuator
2. Set the EUT Work on the top, the middle and the bottom operation frequency individually.
3. Set SPA Centre Frequency = Operation Frequency, RBW= 100 KHz, VBW \geq 3 \times RBW.
4. Set SPA Trace 1 Max hold, then View.

Note: The EUT was tested according to ANSI C63.10 for compliance to FCC PART 15.247 requirements.

8.2. TEST SET-UP (BLOCK DIAGRAM OF CONFIGURATION)

The same as described in section 7.2.

8.3. LIMITS AND MEASUREMENT RESULTS

LIMITS AND MEASUREMENT RESULT			
Applicable Limits	Applicable Limits		
	Test Data (kHz)		Criteria
>500KHZ	Low Channel	711.7	PASS
	Middle Channel	716.4	PASS
	High Channel	705.7	PASS

TEST PLOT OF BANDWIDTH FOR LOW CHANNEL

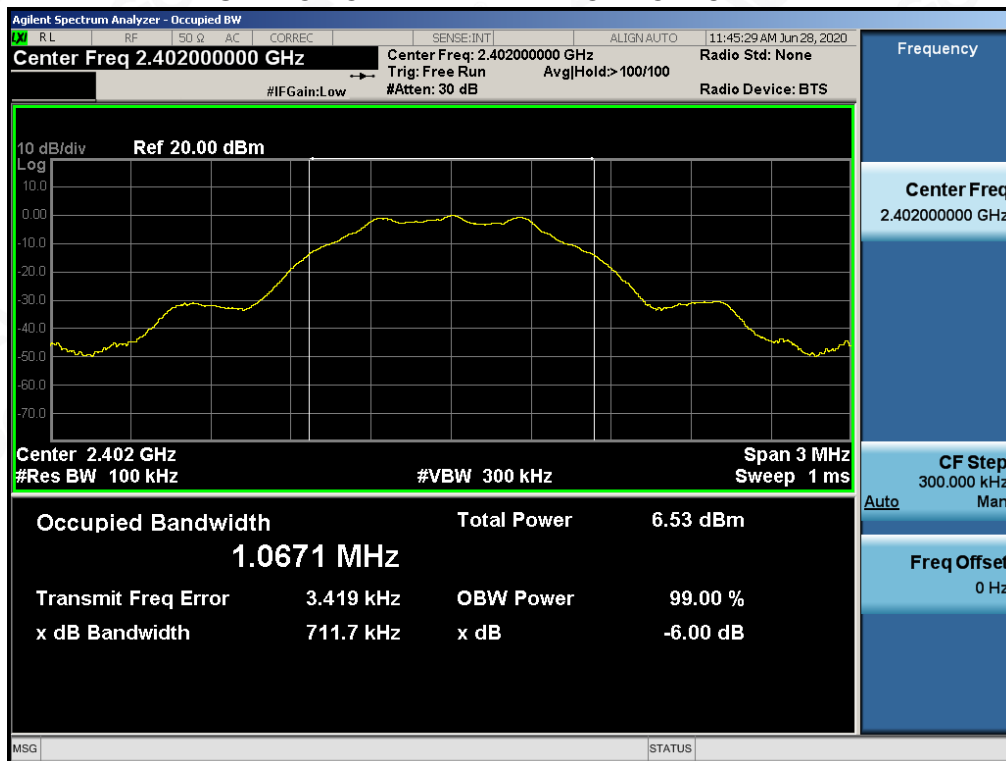

TEST PLOT OF BANDWIDTH FOR MIDDLE CHANNEL

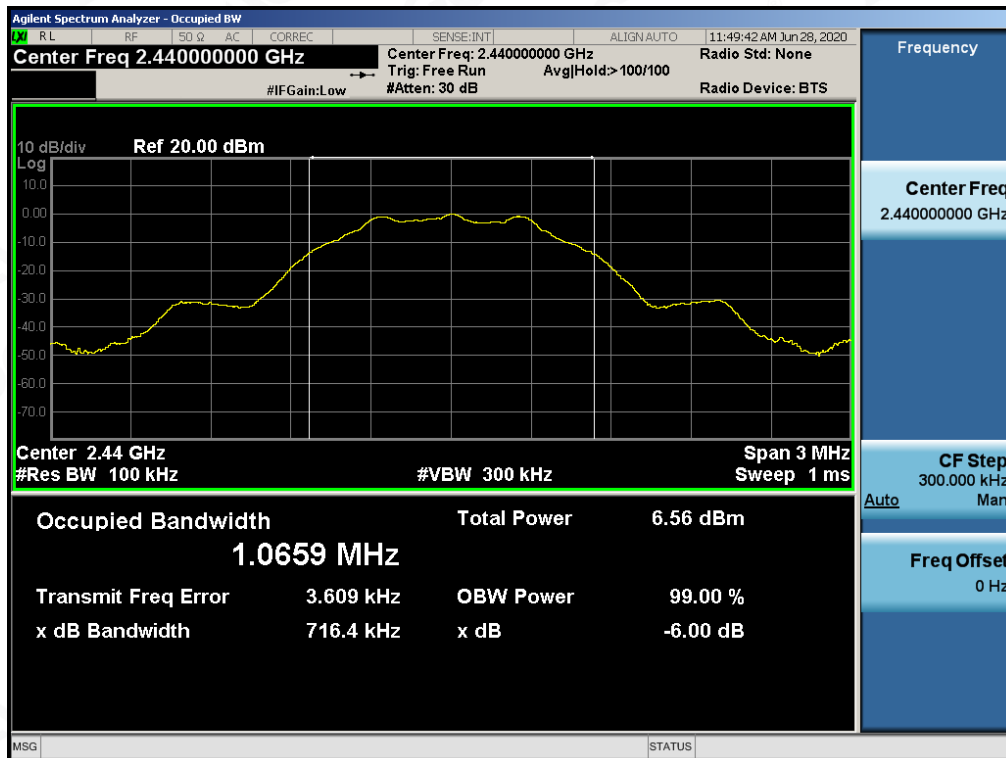

TEST PLOT OF BANDWIDTH FOR HIGH CHANNEL

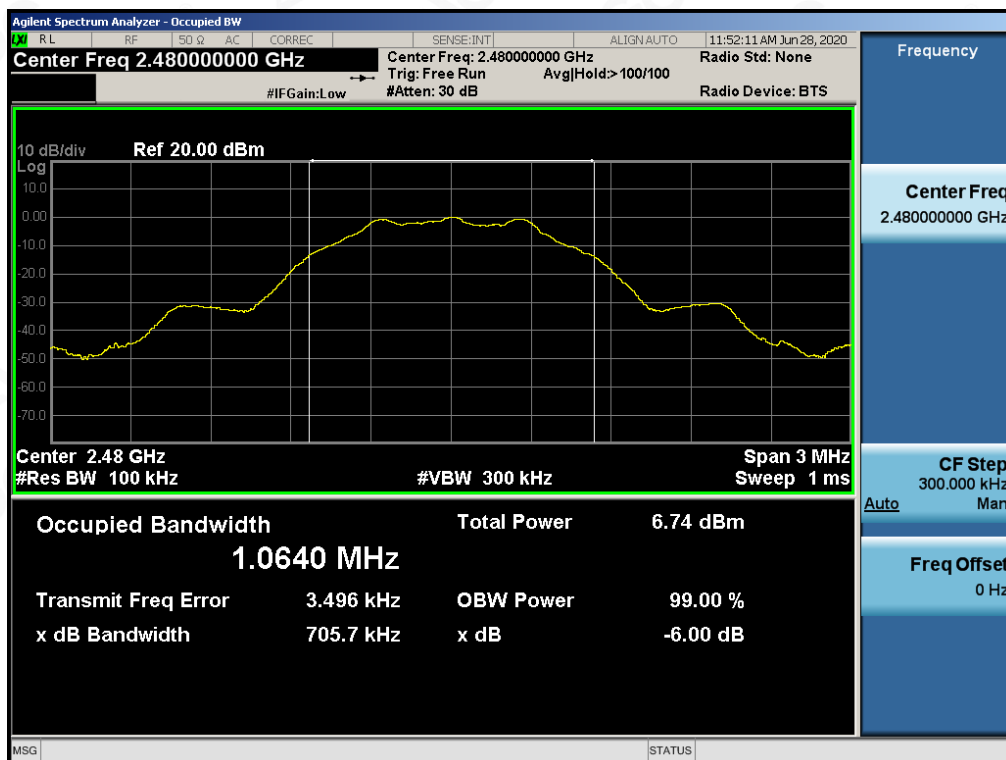

9. CONDUCTED SPURIOUS EMISSION

9.1. MEASUREMENT PROCEDURE

1. Connect EUT RF output port to the Spectrum Analyzer through an RF attenuator
2. Set the EUT Work on the top, the middle and the bottom operation frequency individually.
3. Set SPA Trace 1 Max hold, then View.

Note: The EUT was tested according to ANSI C63.10 for compliance to FCC PART 15.247 requirements.

9.2. TEST SET-UP (BLOCK DIAGRAM OF CONFIGURATION)

The same as described in section 7.2.

9.3. MEASUREMENT EQUIPMENT USED

The same as described in section 6.

9.4. LIMITS AND MEASUREMENT RESULT

LIMITS AND MEASUREMENT RESULT		
Applicable Limits	Measurement Result	
	Test Data	Criteria
In any 100 KHz Bandwidth Outside the frequency band in which the spread spectrum intentional radiator is operating, the radio frequency power that is produce by the intentional radiator shall be at least 20 dB below that in 100KHz bandwidth within the band that contains the highest level of the desired power.	At least -20dBc than the reference level	PASS



**TEST RESULT FOR ENTIRE FREQUENCY RANGE
GFSK MODULATION IN LOW CHANNEL**

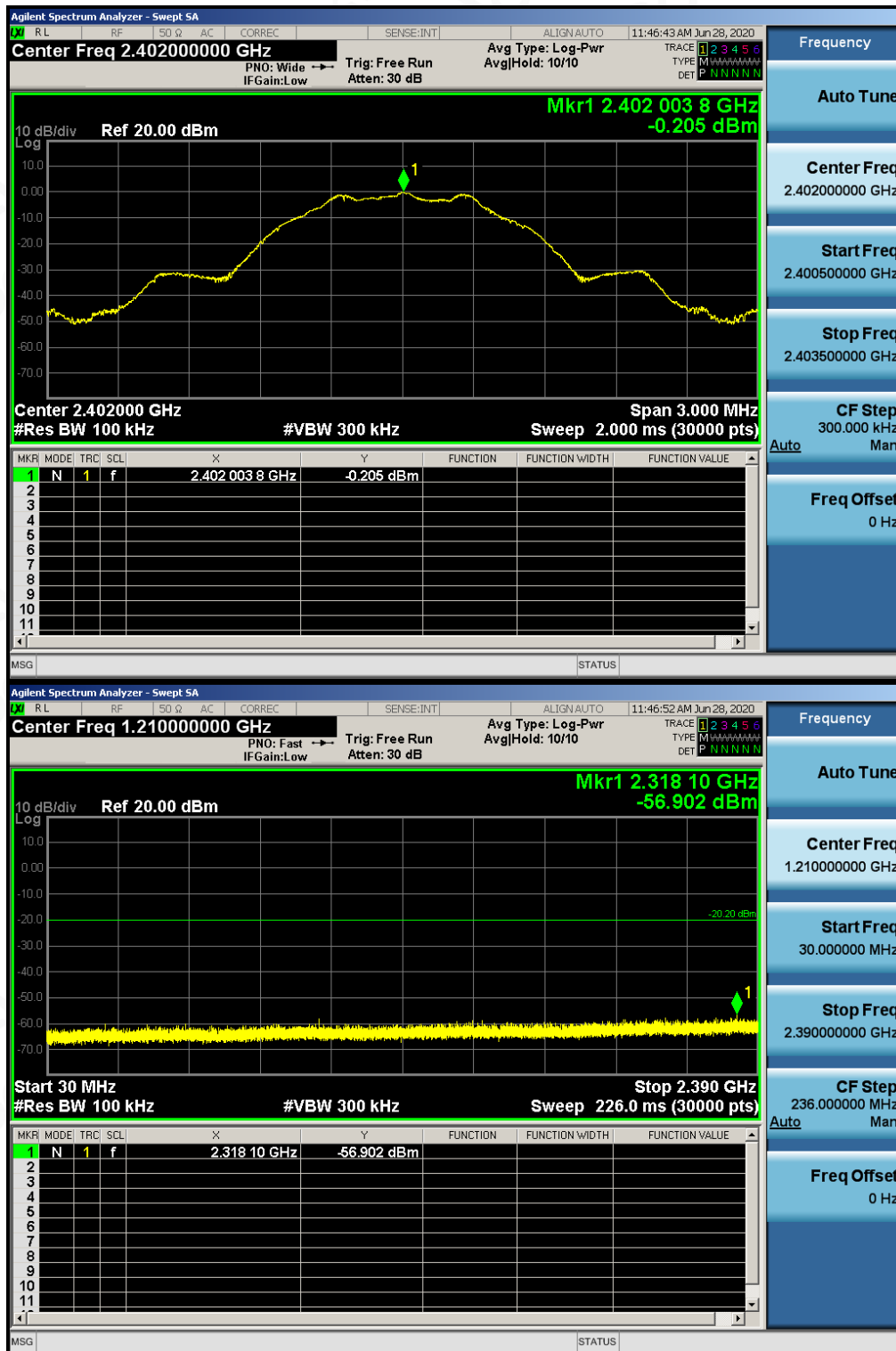

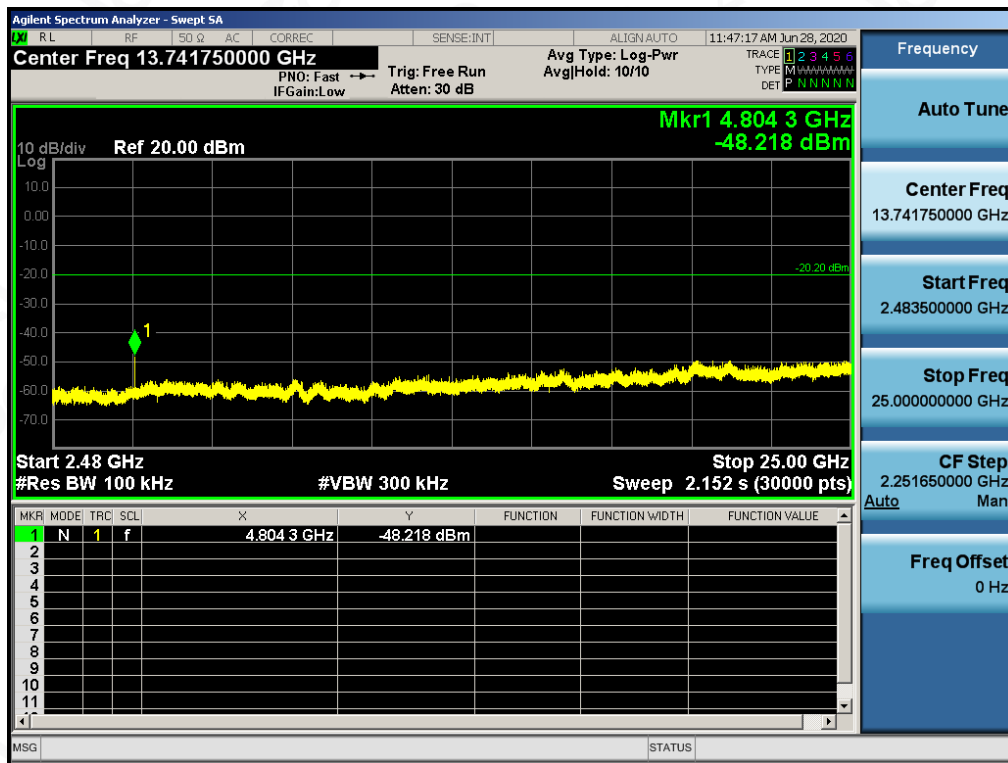

GFSK MODULATION IN MIDDLE CHANNEL

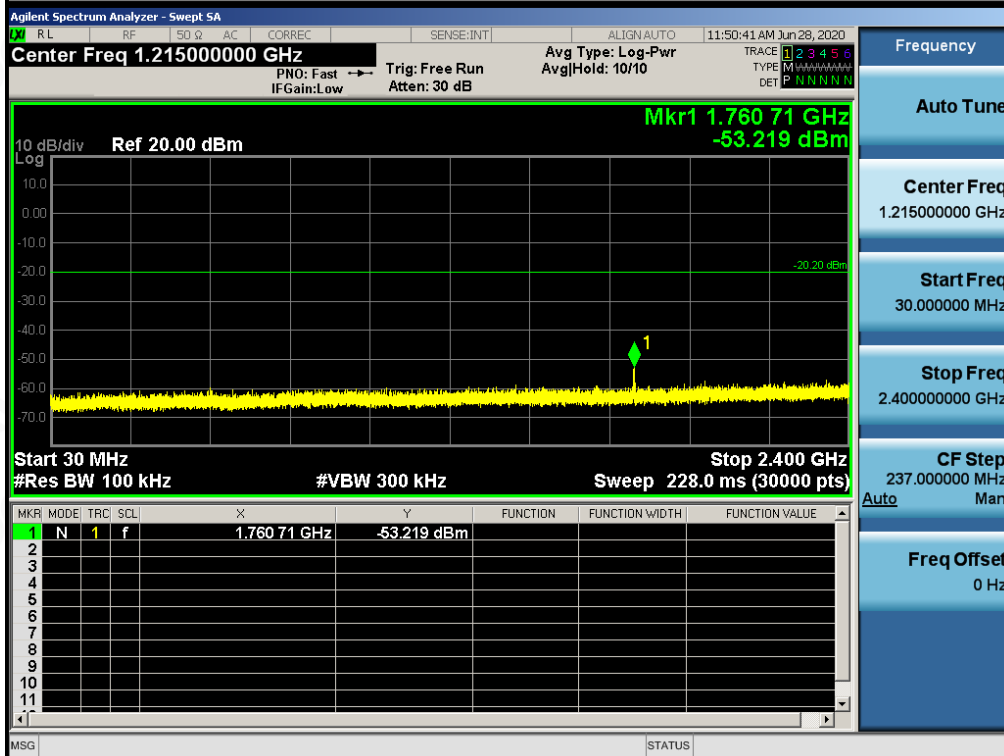
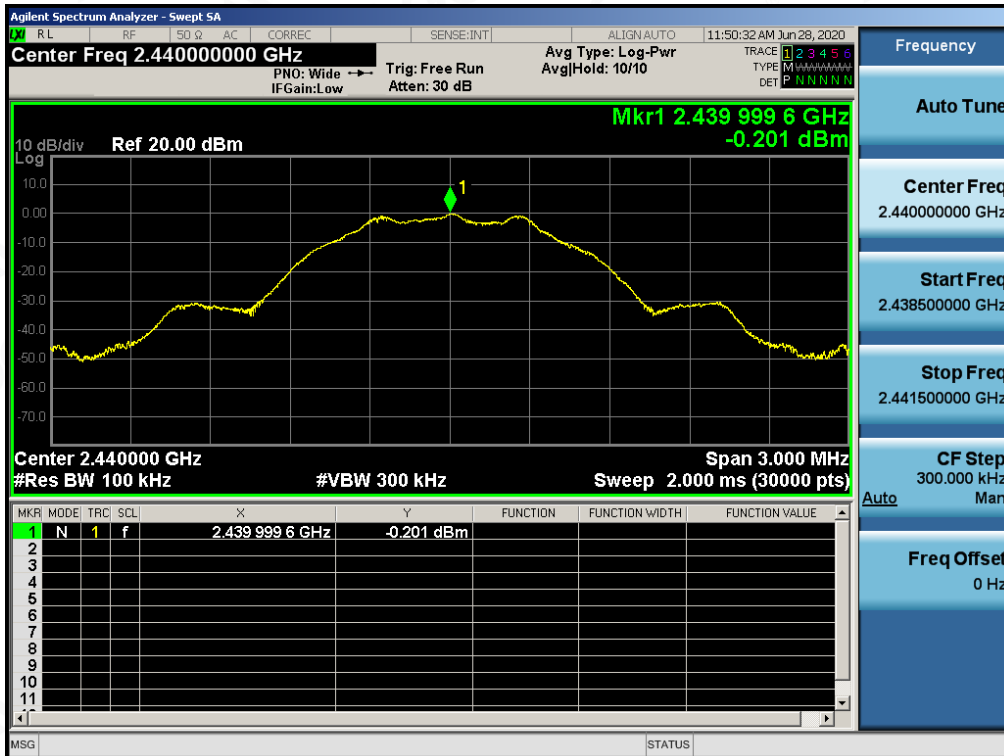

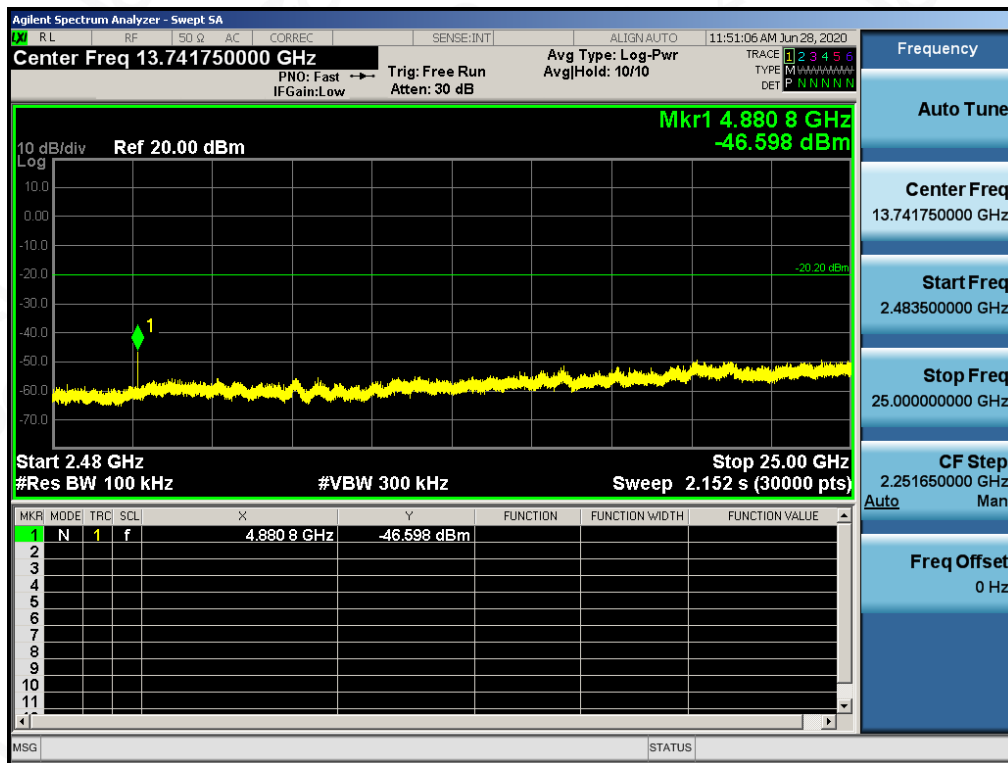

GFSK MODULATION IN HIGH CHANNEL

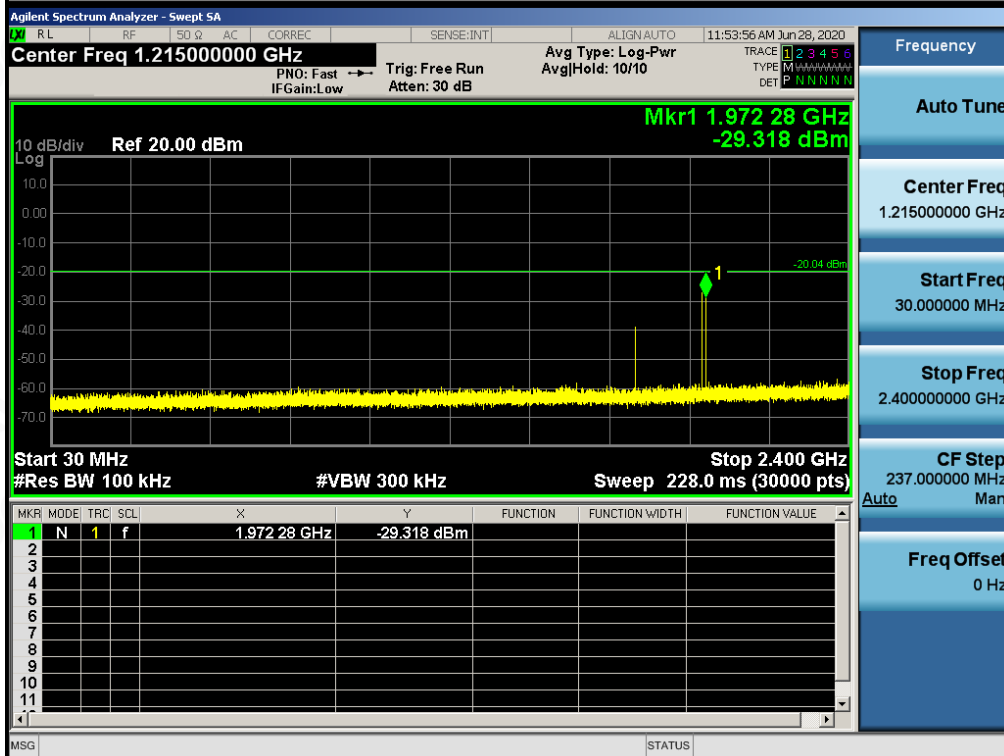
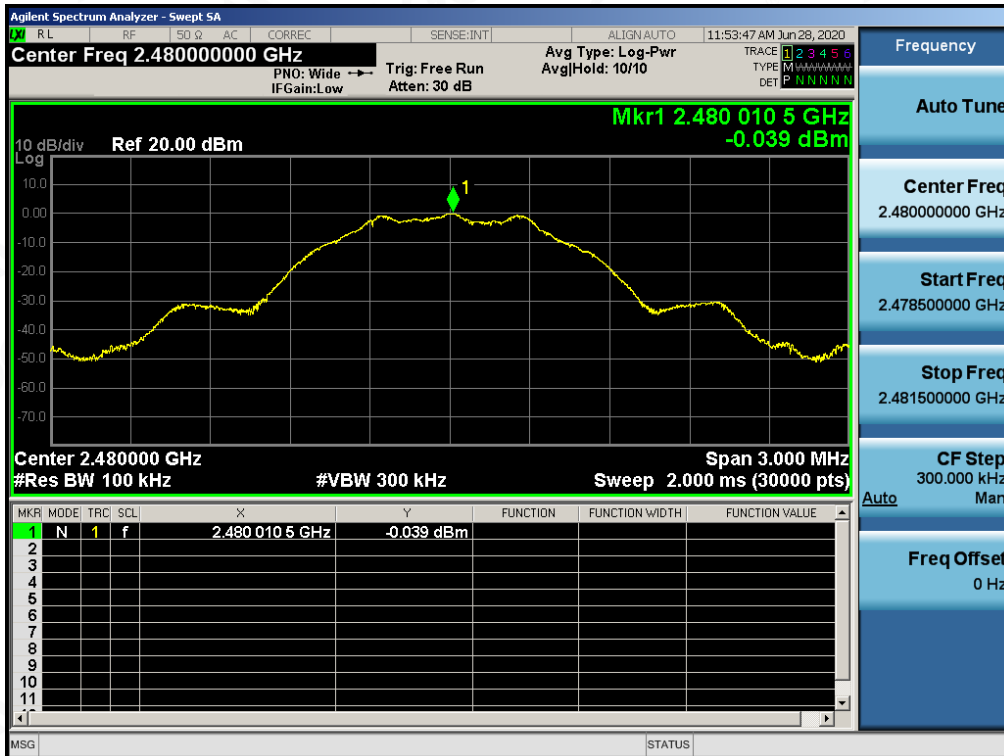

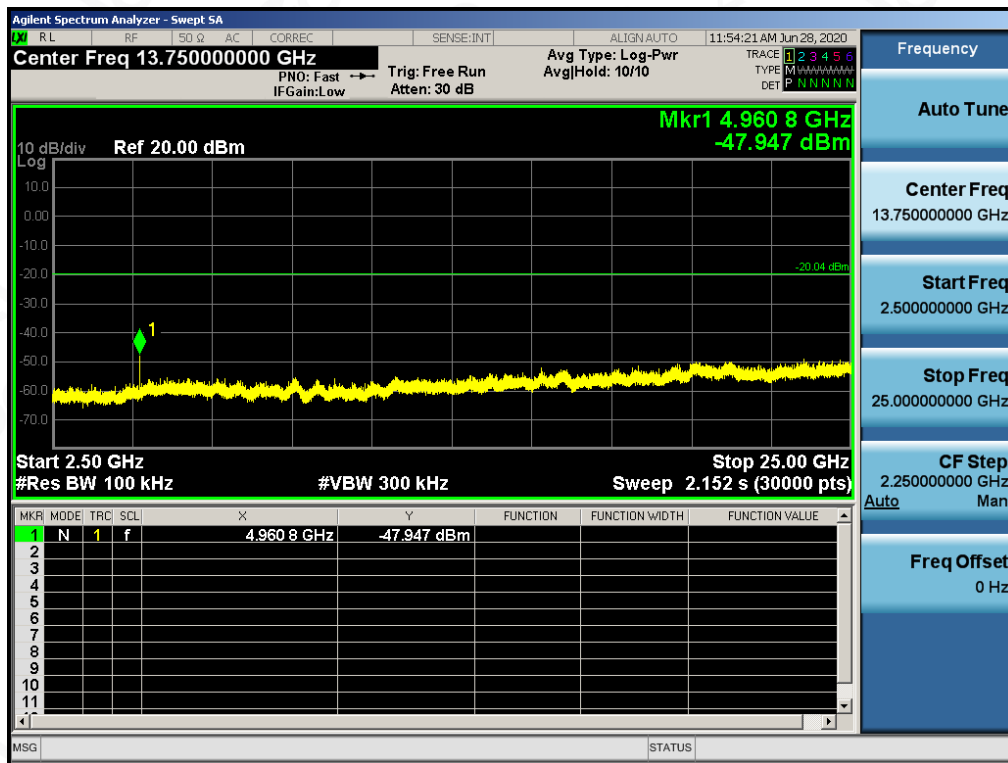

Note: The peak emissions without marker on the above plots are fundamental wave and need not to compare with the limit.



TEST RESULT FOR BAND EDGE GFSK MODULATION IN LOW CHANNEL

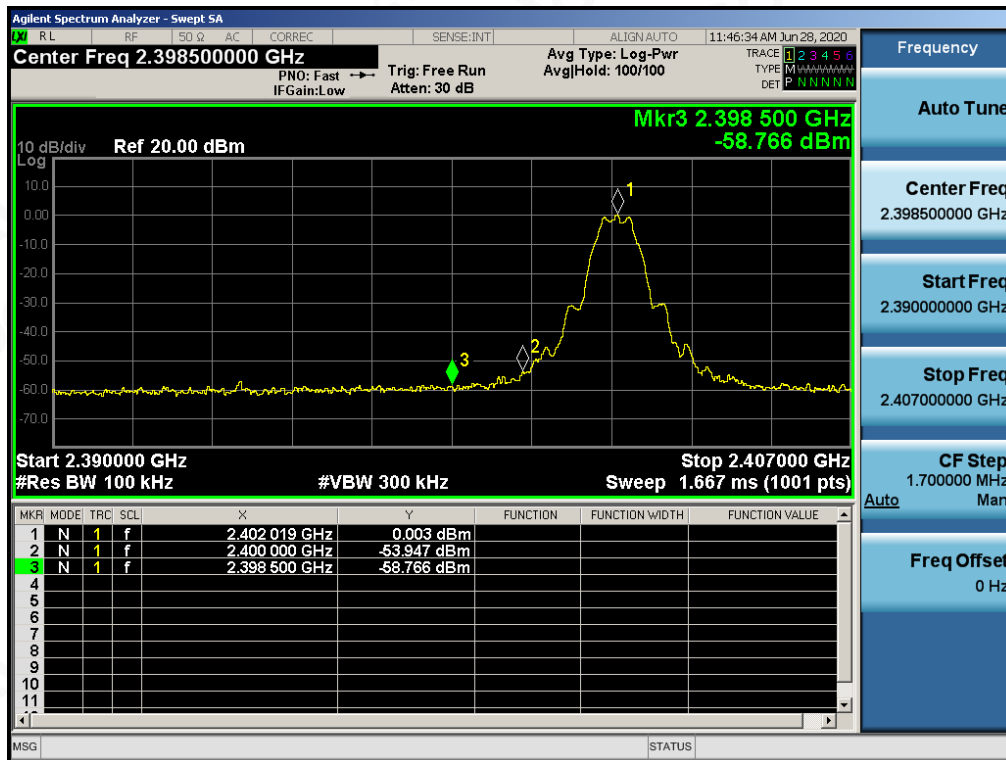

GFSK MODULATION IN HIGH CHANNEL

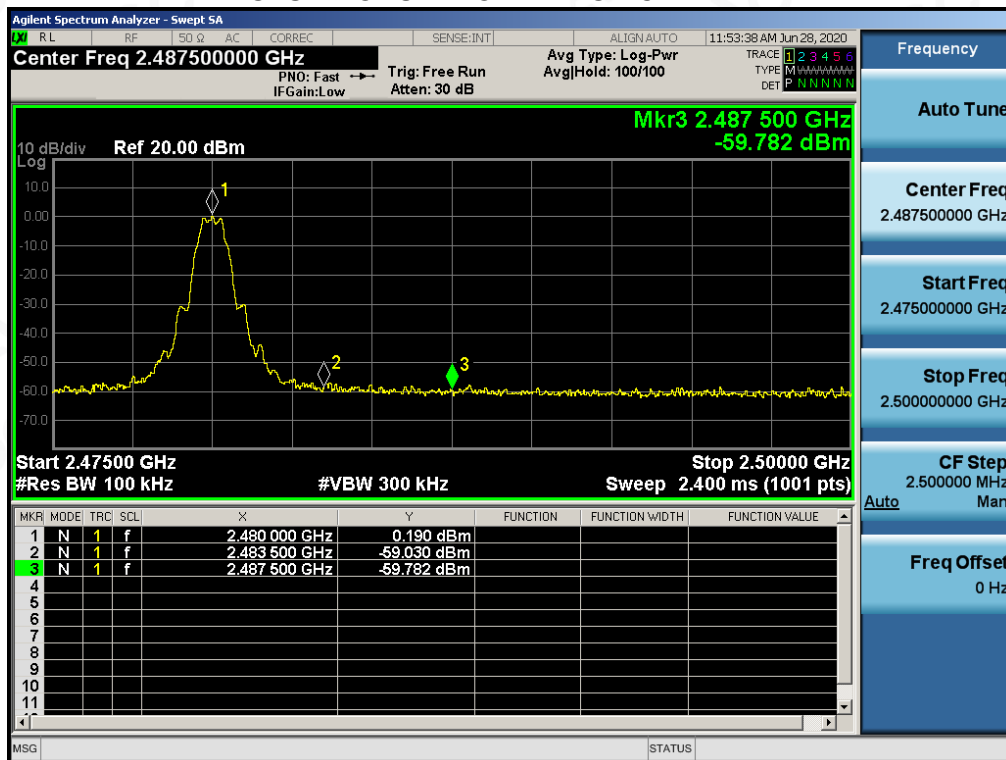

10. MAXIMUM CONDUCTED OUTPUT POWER SPECTRAL DENSITY

10.1 MEASUREMENT PROCEDURE

- (1). Connect EUT RF output port to the Spectrum Analyzer through an RF attenuator
- (2). Set the EUT Work on the top, the middle and the bottom operation frequency individually.
- (3). Set SPA Trace 1 Max hold, then View.

Note: The method of PKPSD in the KDB 558074 item 10.2 was used in this testing.

10.2 TEST SET-UP (BLOCK DIAGRAM OF CONFIGURATION)

Refer To Section 7.2.

10.3 MEASUREMENT EQUIPMENT USED

Refer To Section 6.

10.4 LIMITS AND MEASUREMENT RESULT

Channel No.	PSD (dBm/3kHz)	Limit (dBm/3kHz)	Result
Low Channel	-18.441	8	Pass
Middle Channel	-16.203	8	Pass
High Channel	-15.458	8	Pass

TEST PLOT OF SPECTRAL DENSITY FOR LOW CHANNEL

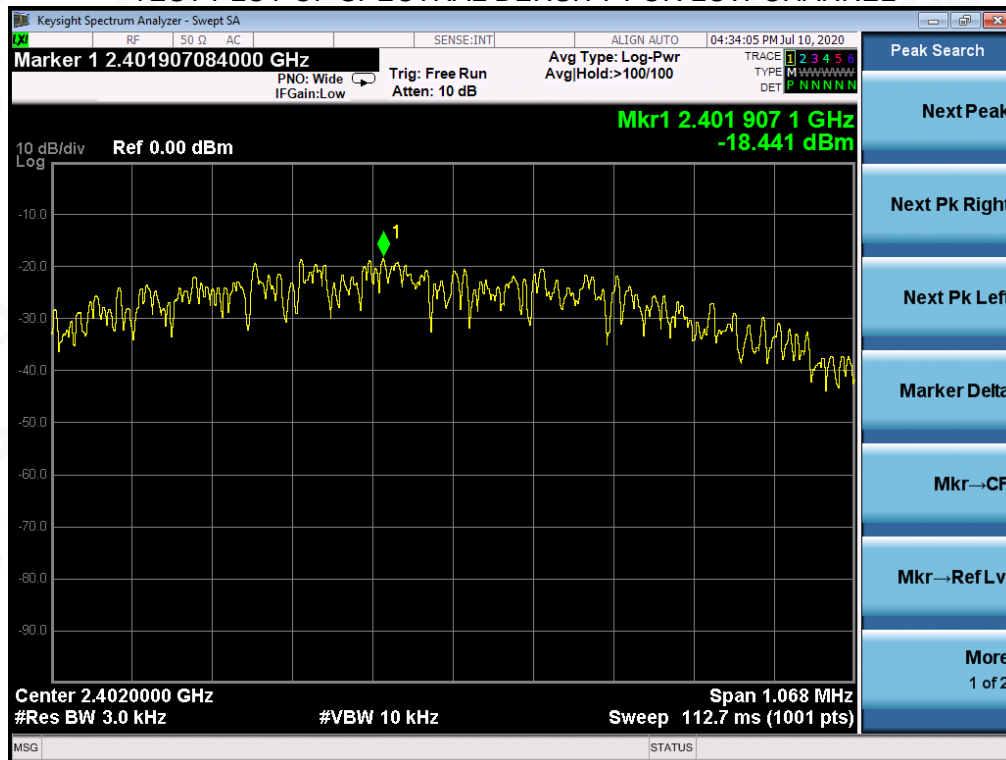

TEST PLOT OF SPECTRAL DENSITY FOR MIDDLE CHANNEL

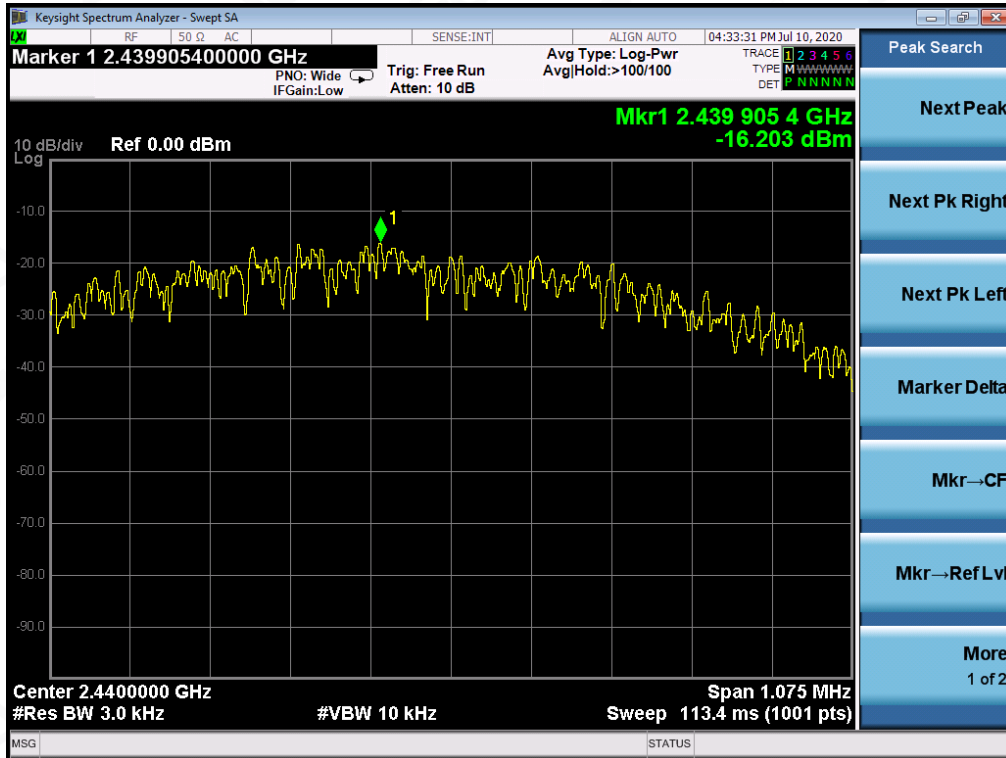

TEST PLOT OF SPECTRAL DENSITY FOR HIGH CHANNEL

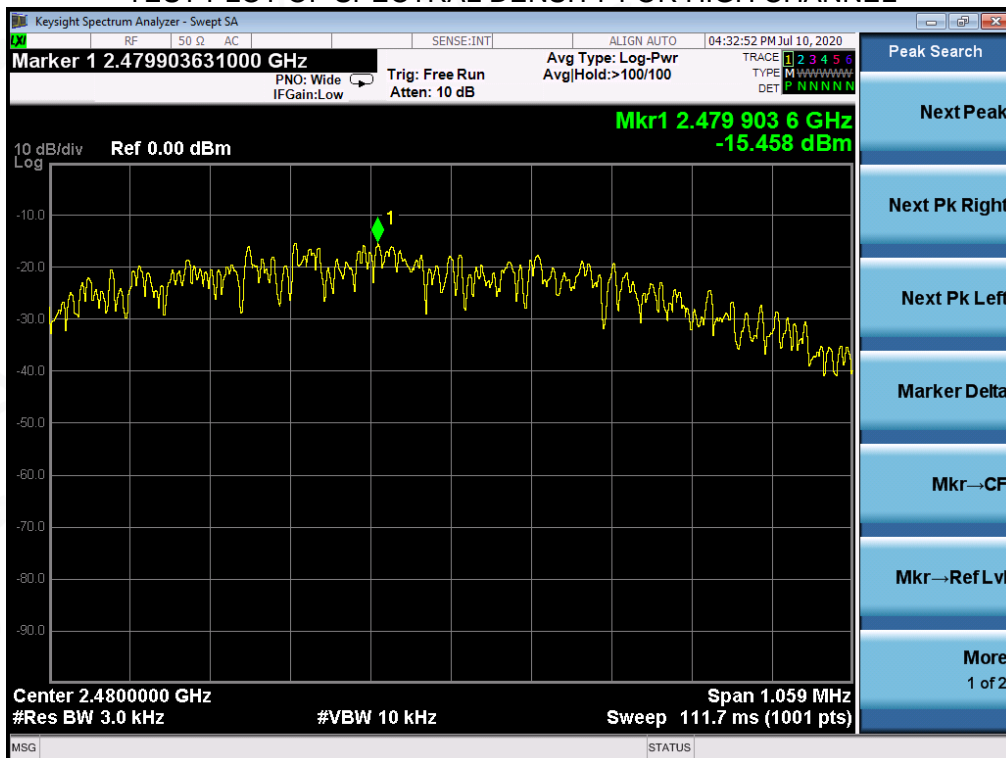

11. RADIATED EMISSION

11.1. MEASUREMENT PROCEDURE

1. The EUT was placed on the top of the turntable 0.8 or 1.5 meter above ground. The phase center of the receiving antenna mounted on the top of a height-variable antenna tower was placed 3 meters far away from the turntable.
2. Power on the EUT and all the supporting units. The turntable was rotated by 360 degrees to determine the position of the highest radiation.
3. The height of the broadband receiving antenna was varied between one meter and four meters above ground to find the maximum emissions field strength of both horizontal and vertical polarization.
4. For each suspected emissions, the antenna tower was scan (from 1 M to 4 M) and then the turntable was rotated (from 0 degree to 360 degrees) to find the maximum reading.
5. Set the test-receiver system to Peak or CISPR quasi-peak Detect Function with specified bandwidth under Maximum Hold Mode.
6. For emissions above 1GHz, use 1MHz RBW and 3MHz VBW for peak reading. Place the measurement antenna away from each area of the EUT determined to be a source of emissions at the specified measurement distance, while keeping the measurement antenna aimed at the source of emissions at each frequency of significant emissions, with polarization oriented for maximum response. The measurement antenna may have to be higher or lower than the EUT, depending on the radiation pattern of the emission and staying aimed at the emission source for receiving the maximum signal. The final measurement antenna elevation shall be that which maximizes the emissions. The measurement antenna elevation for maximum emissions shall be restricted to a range of heights of from 1 m to 4 m above the ground or reference ground plane.
7. When the radiated emissions limits are expressed in terms of the average value of the emissions, and pulsed operation is employed, the measurement field strength shall be determined by averaging over one complete pulse train, including blanking intervals, as long as the pulse train does not exceed 0.1 seconds. As an alternative (provided the transmitter operates for longer than 0.1 seconds) or in cases where the pulse train exceeds 0.1 seconds, the measured field strength shall be determined from the average absolute voltage during a 0.1 second interval during which the field strength is at its maximum values.
8. If the emissions level of the EUT in peak mode was 3 dB lower than the average limit specified, then testing will be stopped and peak values of EUT will be reported, otherwise, the emissions which do not have 3 dB margin will be repeated one by one using the quasi-peak method for below 1GHz.
9. For testing above 1GHz, the emissions level of the EUT in peak mode was lower than average limit (that means the emissions level in peak mode also complies with the limit in average mode), then testing will be stopped and peak values of EUT will be reported, otherwise, the emissions will be measured in average mode again and reported.
10. In case the emission is lower than 30MHz, loop antenna has to be used for measurement and the recorded data should be QP measured by receiver. High - Low scan is not required in this case.



11.2. TEST SETUP

Radiated Emission Test-Setup Frequency Below 30MHz

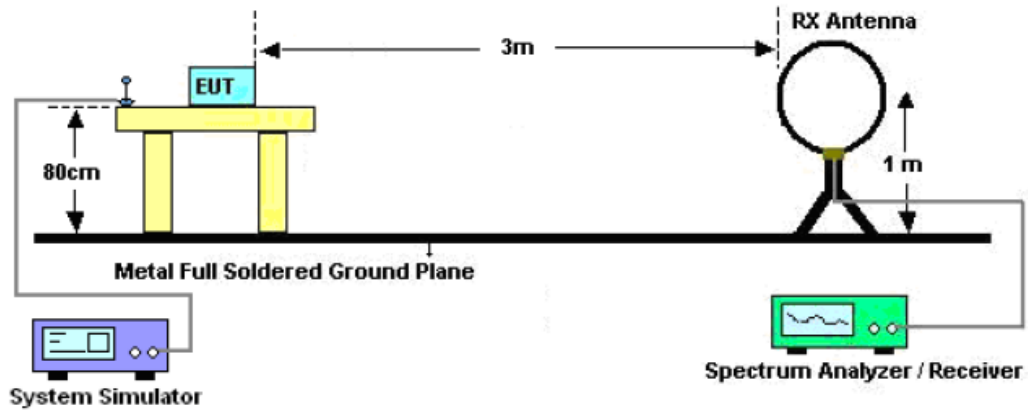

RADIATED EMISSION TEST SETUP 30MHz-1000MHz

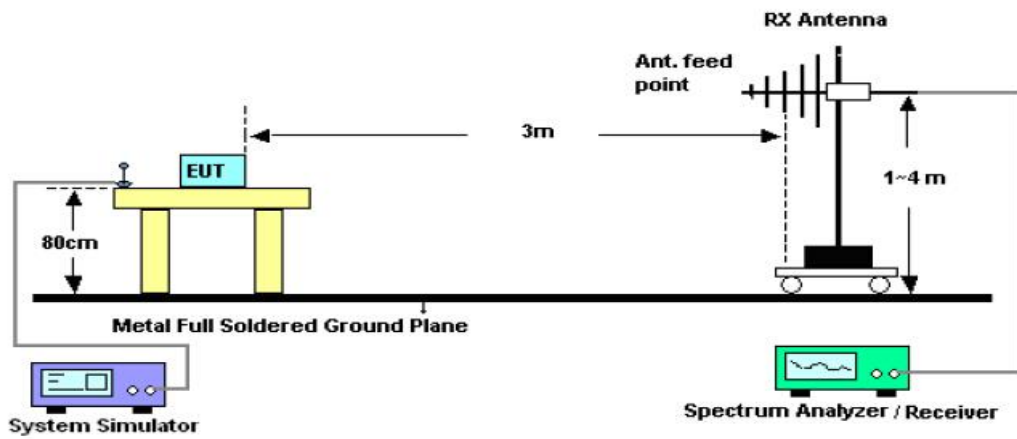

RADIATED EMISSION TEST SETUP ABOVE 1000MHz

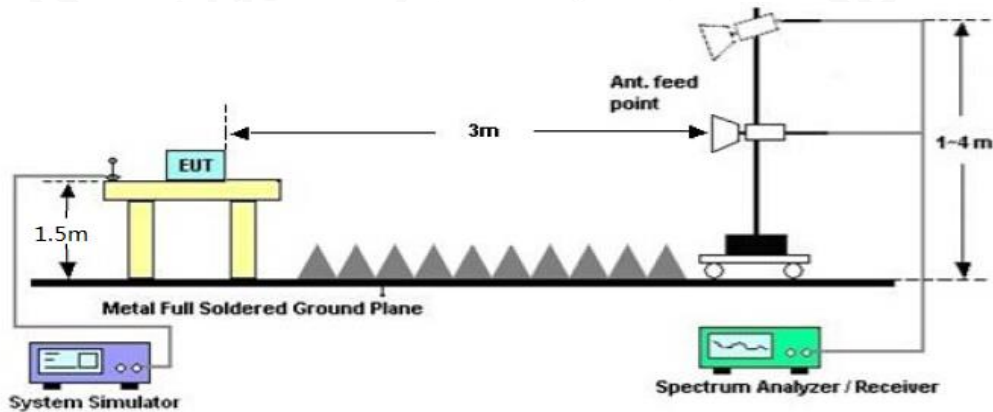

11.3. LIMITS AND MEASUREMENT RESULT

15.209 Limit in the below table has to be followed

Frequencies (MHz)	Field Strength (micorvolts/meter)	Measurement Distance (meters)
0.009~0.490	2400/F(KHz)	300
0.490~1.705	24000/F(KHz)	30
1.705~30.0	30	30
30~88	100	3
88~216	150	3
216~960	200	3
Above 960	500	3

Note: All modes were tested For restricted band radiated emission, the test records reported below are the worst result compared to other modes.

11.4. TEST RESULT

RADIATED EMISSION BELOW 30MHZ

No emission found between lowest internal used/generated frequencies to 30MHz.



RADIATED EMISSION BELOW 1GHZ

EUT	TRUE WIRELESS ACTIVE HEADPHONE	Model Name	GOAL
Temperature	25° C	Relative Humidity	55.4%
Pressure	960hPa	Test Voltage	Normal Voltage
Test Mode	Mode 3	Antenna	Horizontal

66.9 dBuV/m

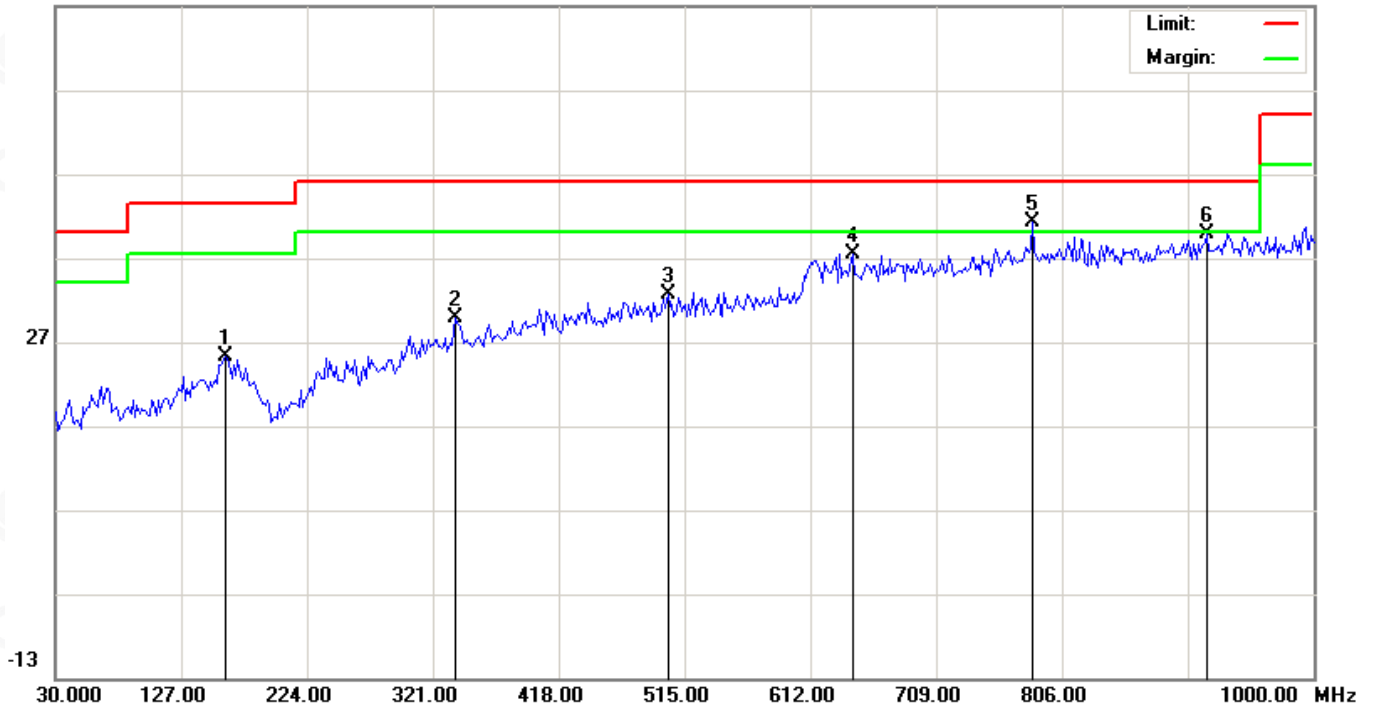

No.	Mk	Freq.	Reading	Factor	Measurement	Limit	Over	Detector
		MHz	dBuV	dB/m	dBuV/m	dBuV/m	dB	
1		160.9500	6.21	19.09	25.30	43.50	-18.20	peak
2		338.7833	8.95	20.83	29.78	46.00	-16.22	peak
3		502.0667	7.52	25.03	32.55	46.00	-13.45	peak
4		644.3333	9.85	27.48	37.33	46.00	-8.67	peak
5	*	783.3667	11.20	30.03	41.23	46.00	-4.77	peak
6		917.5500	7.95	31.85	39.80	46.00	-6.20	peak

RESULT: PASS

EUT	TRUE WIRELESS ACTIVE HEADPHONE	Model Name	GOAL
Temperature	25° C	Relative Humidity	55.4%
Pressure	960hPa	Test Voltage	Normal Voltage
Test Mode	Mode 3	Antenna	Vertical

66.9 dBuV/m

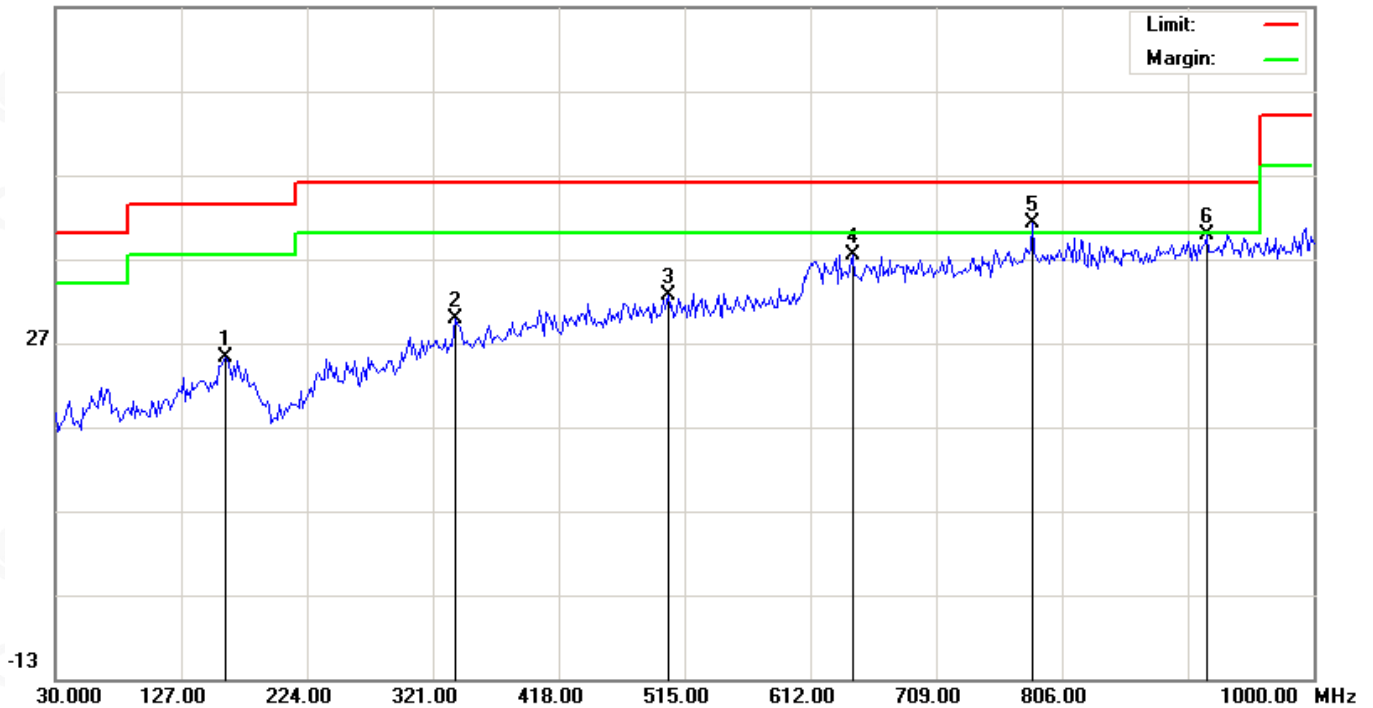

No.	Mk	Freq.	Reading	Factor	Measurement	Limit	Over	Detector
		MHz	dBuV	dB/m	dBuV/m	dBuV/m	dB	
1		160.9500	6.21	19.09	25.30	43.50	-18.20	peak
2		338.7833	8.95	20.83	29.78	46.00	-16.22	peak
3		502.0667	7.52	25.03	32.55	46.00	-13.45	peak
4		644.3333	9.85	27.48	37.33	46.00	-8.67	peak
5	*	783.3667	11.20	30.03	41.23	46.00	-4.77	peak
6		917.5500	7.95	31.85	39.80	46.00	-6.20	peak

RESULT: PASS
Note: 1. Factor=Antenna Factor + Cable loss, Margin=Measurement-Limit.

2. All test modes had been tested. The mode 3 is the worst case and recorded in the report.



RADIATED EMISSION ABOVE 1GHZ

EUT	TRUE WIRELESS ACTIVE HEADPHONE	Model Name	GOAL
Temperature	25° C	Relative Humidity	55.4%
Pressure	960hPa	Test Voltage	Normal Voltage
Test Mode	Mode 1	Antenna	Horizontal

Frequency (MHz)	Meter Reading (dBμV)	Factor (dB)	Emission Level (dBμV/m)	Limits (dBμV/m)	Margin (dB)	Value Type
4804.000	43.25	0.08	43.33	74	-30.67	peak
4804.000	34.31	0.08	34.39	54	-19.61	AVG
7206.000	38.64	2.21	40.85	74	-33.15	peak
7206.000	31.79	2.21	34	54	-20	AVG

Remark:

Factor = Antenna Factor + Cable Loss – Pre-amplifier.

EUT	TRUE WIRELESS ACTIVE HEADPHONE	Model Name	GOAL
Temperature	25° C	Relative Humidity	55.4%
Pressure	960hPa	Test Voltage	Normal Voltage
Test Mode	Mode 1	Antenna	Vertical

Frequency (MHz)	Meter Reading (dBμV)	Factor (dB)	Emission Level (dBμV/m)	Limits (dBμV/m)	Margin (dB)	Value Type
4804.000	45.81	0.08	45.89	74	-28.11	peak
4804.000	35.79	0.08	35.87	54	-18.13	AVG
7206.000	38.47	2.21	40.68	74	-33.32	peak
7206.000	31.27	2.21	33.48	54	-20.52	AVG

Remark:

Factor = Antenna Factor + Cable Loss – Pre-amplifier.



EUT	TRUE WIRELESS ACTIVE HEADPHONE	Model Name	GOAL
Temperature	25° C	Relative Humidity	55.4%
Pressure	960hPa	Test Voltage	Normal Voltage
Test Mode	Mode 2	Antenna	Horizontal

Frequency (MHz)	Meter Reading (dBμV)	Factor (dB)	Emission Level (dBμV/m)	Limits (dBμV/m)	Margin (dB)	Value Type
4880.000	45.76	0.14	45.9	74	-28.1	peak
4880.000	36.24	0.14	36.38	54	-17.62	AVG
7320.000	39.34	2.36	41.7	74	-32.3	peak
7320.000	31.83	2.36	34.19	54	-19.81	AVG

Remark:

Factor = Antenna Factor + Cable Loss – Pre-amplifier.

EUT	TRUE WIRELESS ACTIVE HEADPHONE	Model Name	GOAL
Temperature	25° C	Relative Humidity	55.4%
Pressure	960hPa	Test Voltage	Normal Voltage
Test Mode	Mode 2	Antenna	Vertical

Frequency (MHz)	Meter Reading (dBμV)	Factor (dB)	Emission Level (dBμV/m)	Limits (dBμV/m)	Margin (dB)	Value Type
4880.000	46.58	0.14	46.72	74	-27.28	peak
4880.000	37.34	0.14	37.48	54	-16.52	AVG
7320.000	40.19	2.36	42.55	74	-31.45	peak
7320.000	33.76	2.36	36.12	54	-17.88	AVG

Remark:

Factor = Antenna Factor + Cable Loss – Pre-amplifier.



EUT	TRUE WIRELESS ACTIVE HEADPHONE	Model Name	GOAL
Temperature	25° C	Relative Humidity	55.4%
Pressure	960hPa	Test Voltage	Normal Voltage
Test Mode	Mode 3	Antenna	Horizontal

Frequency (MHz)	Meter Reading (dBμV)	Factor (dB)	Emission Level (dBμV/m)	Limits (dBμV/m)	Margin (dB)	Value Type
4960.000	44.97	0.22	45.19	74	-28.81	peak
4960.000	36.49	0.22	36.71	54	-17.29	AVG
7440.000	38.17	2.64	40.81	74	-33.19	peak
7440.000	31.64	2.64	34.28	54	-19.72	AVG

Remark:

Factor = Antenna Factor + Cable Loss – Pre-amplifier.

EUT	TRUE WIRELESS ACTIVE HEADPHONE	Model Name	GOAL
Temperature	25° C	Relative Humidity	55.4%
Pressure	960hPa	Test Voltage	Normal Voltage
Test Mode	Mode 3	Antenna	Vertical

Frequency (MHz)	Meter Reading (dBμV)	Factor (dB)	Emission Level (dBμV/m)	Limits (dBμV/m)	Margin (dB)	Value Type
4960.000	46.27	0.22	46.49	74	-27.51	peak
4960.000	36.88	0.22	37.1	54	-16.9	AVG
7440.000	40.46	2.64	43.1	74	-30.9	peak
7440.000	33.16	2.64	35.8	54	-18.2	AVG

Remark:

Factor = Antenna Factor + Cable Loss – Pre-amplifier.

RESULT: PASS
Note: Other emissions from 1G to 25 GHz are considered as ambient noise. No recording in the test report.

Factor = Antenna Factor + Cable loss - Amplifier gain, Over=Measure-Limit.

The "Factor" value can be calculated automatically by software of measurement system.



TEST RESULT FOR RESTRICTED BANDS REQUIREMENTS

EUT	TRUE WIRELESS ACTIVE HEADPHONE	Model Name	GOAL
Temperature	25° C	Relative Humidity	55.4%
Pressure	960hPa	Test Voltage	Normal Voltage
Test Mode	Mode 1	Antenna	Horizontal

PK

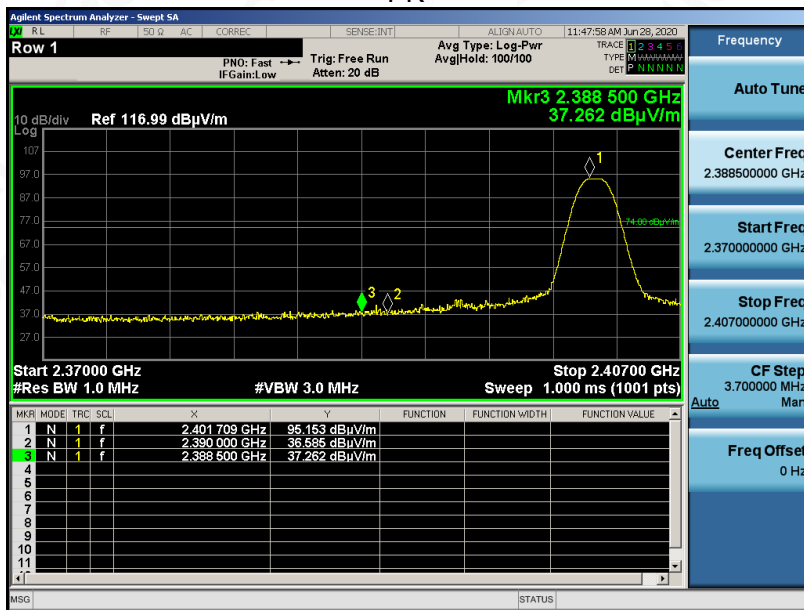

AV

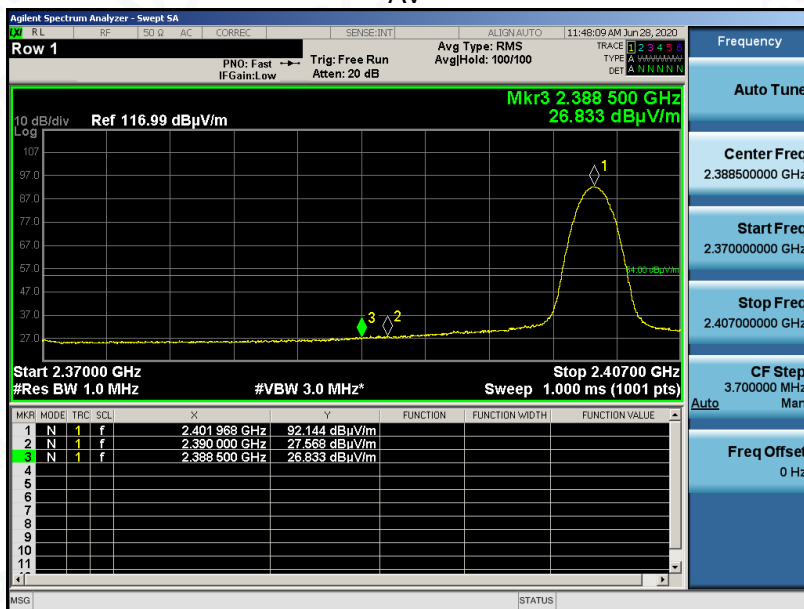

RESULT: PASS



EUT	TRUE WIRELESS ACTIVE HEADPHONE	Model Name	GOAL
Temperature	25° C	Relative Humidity	55.4%
Pressure	960hPa	Test Voltage	Normal Voltage
Test Mode	Mode 1	Antenna	Vertical

PK

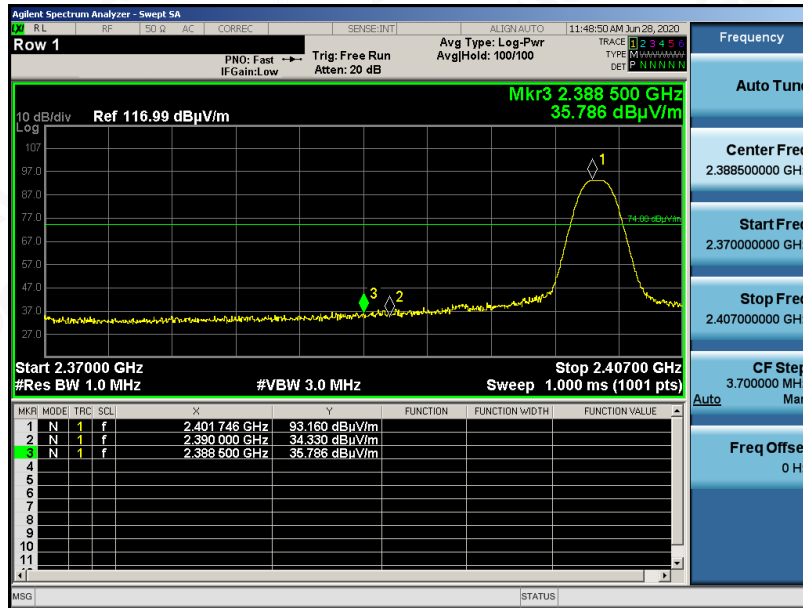

AV

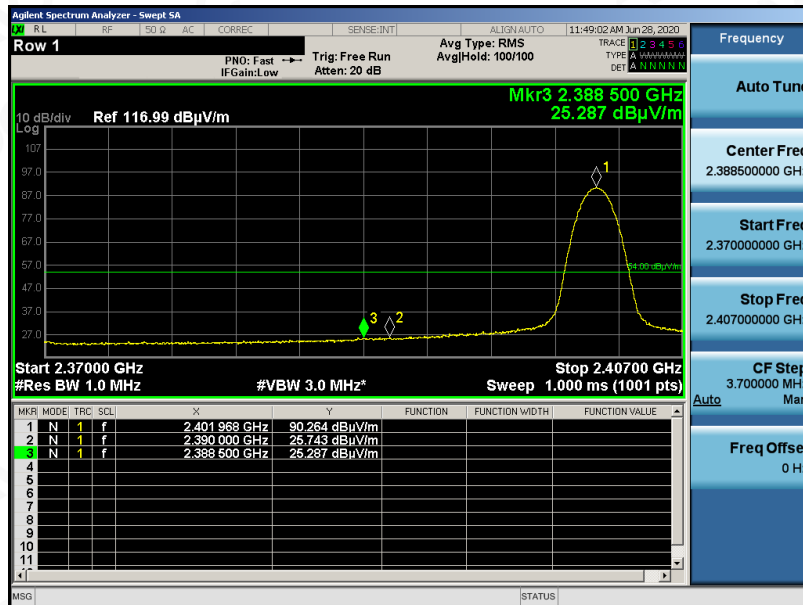

RESULT: PASS



EUT	TRUE WIRELESS ACTIVE HEADPHONE	Model Name	GOAL
Temperature	25° C	Relative Humidity	55.4%
Pressure	960hPa	Test Voltage	Normal Voltage
Test Mode	Mode 3	Antenna	Horizontal

PK

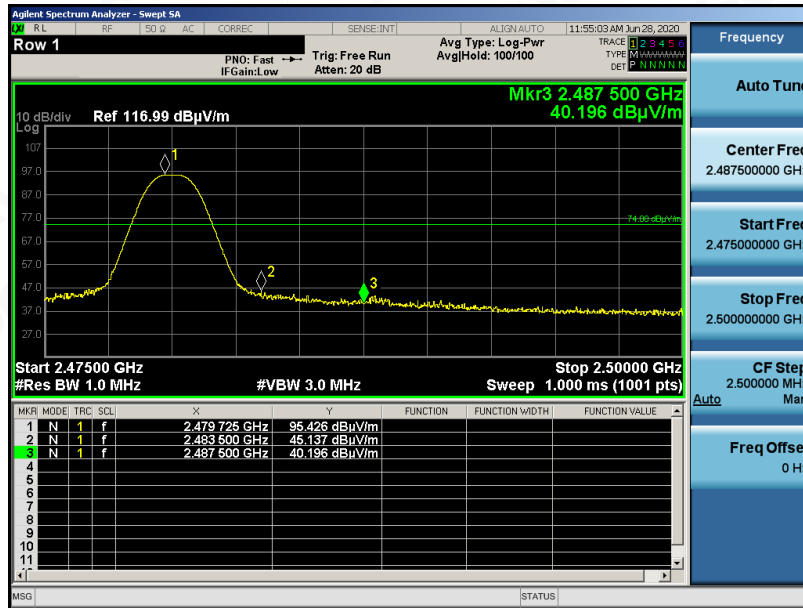

AV

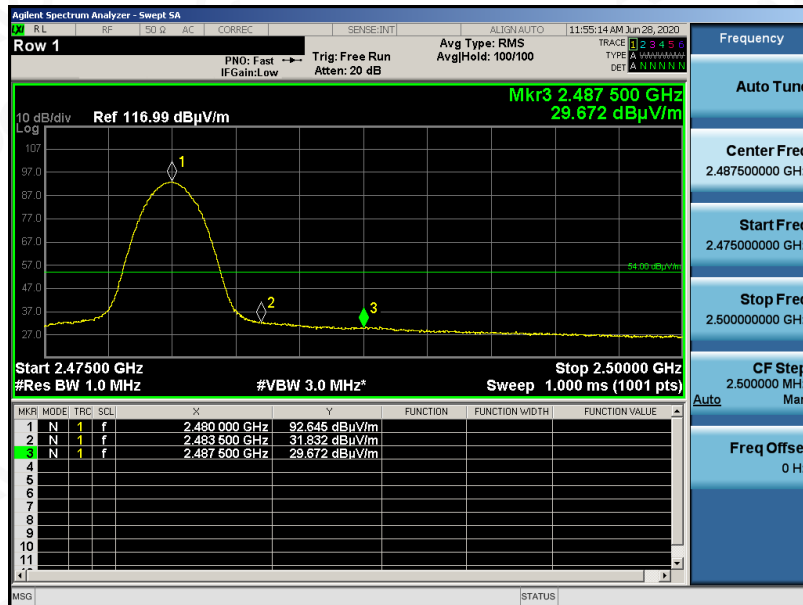

RESULT: PASS



EUT	TRUE WIRELESS ACTIVE HEADPHONE	Model Name	GOAL
Temperature	25° C	Relative Humidity	55.4%
Pressure	960hPa	Test Voltage	Normal Voltage
Test Mode	Mode 3	Antenna	Vertical

PK

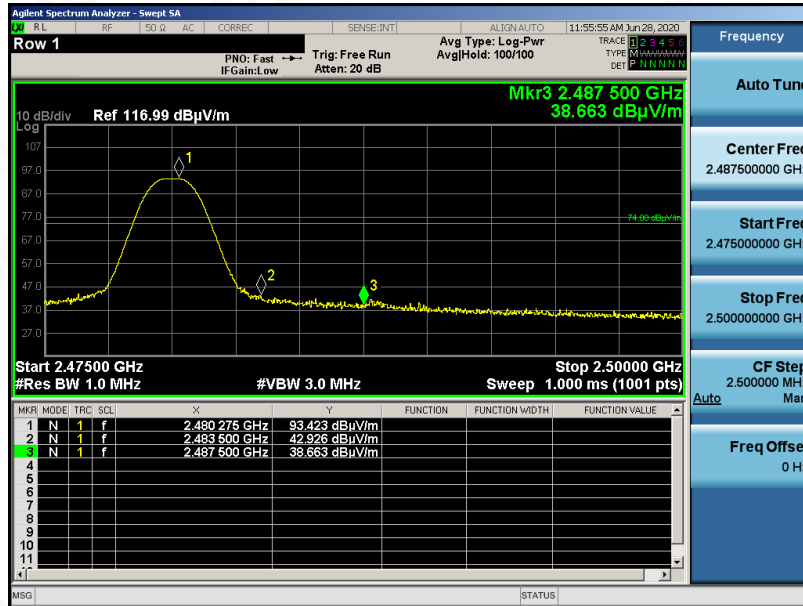

AV

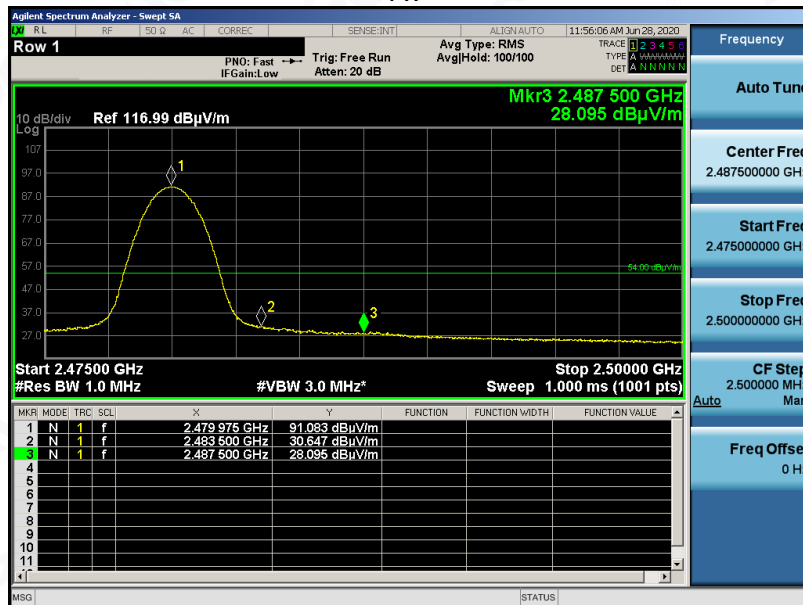

RESULT: PASS

Note: The factor had been edited in the "Input Correction" of the Spectrum Analyzer.



14. FCC LINE CONDUCTED EMISSION TEST

14.1. LIMITS OF LINE CONDUCTED EMISSION TEST

Frequency	Maximum RF Line Voltage	
	Q.P.(dBuV)	Average(dBuV)
150kHz~500kHz	66-56	56-46
500kHz~5MHz	56	46
5MHz~30MHz	60	50

Note: 1. The lower limit shall apply at the transition frequency.

2. The limit decreases linearly with the logarithm of the frequency in the range 0.15 MHz to 0.50 MHz.

14.2. BLOCK DIAGRAM OF LINE CONDUCTED EMISSION TEST

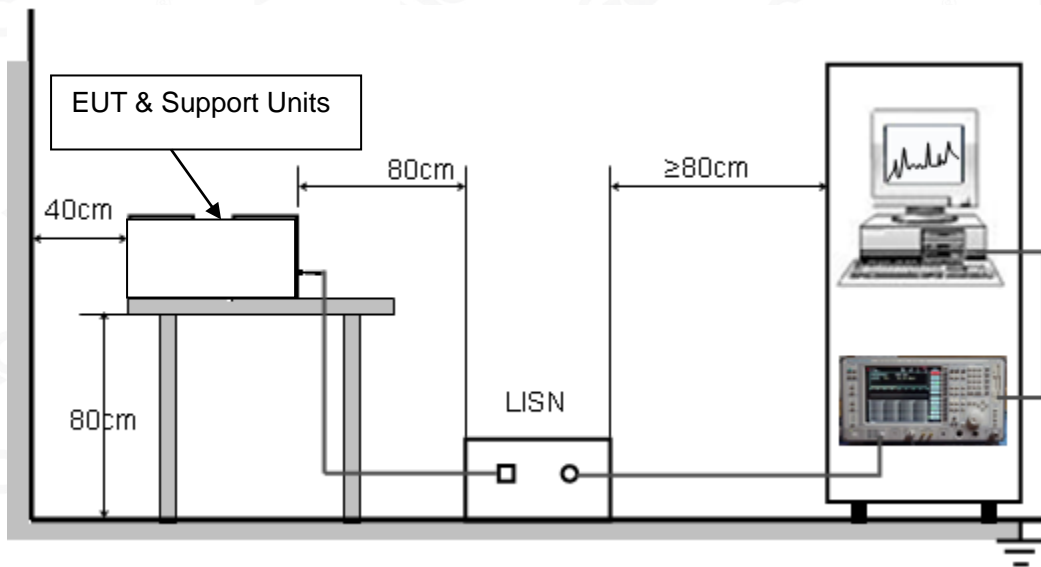

14.3. PRELIMINARY PROCEDURE OF LINE CONDUCTED EMISSION TEST

1. The equipment was set up as per the test configuration to simulate typical actual usage per the user's manual. When the EUT is a tabletop system, a wooden table with a height of 0.8 meters is used and is placed on the ground plane as per ANSI C63.10 (see Test Facility for the dimensions of the ground plane used). When the EUT is a floor-standing equipment, it is placed on the ground plane which has a 3-12 mm non-conductive covering to insulate the EUT from the ground plane.
2. Support equipment, if needed, was placed as per ANSI C63.10.
3. All I/O cables were positioned to simulate typical actual usage as per ANSI C63.10.
4. All support equipments received AC120V/60Hz power from a LISN, if any.
5. The EUT received power from control board which received AC120V/60Hz power from a LISN.
6. The test program was started. Emissions were measured on each current carrying line of the EUT using a spectrum Analyzer / Receiver connected to the LISN powering the EUT. The LISN has two monitoring points: Line 1 (Hot Side) and Line 2 (Neutral Side). Two scans were taken: one with Line 1 connected to Analyzer / Receiver and Line 2 connected to a 50 ohm load; the second scan had Line 1 connected to a 50 ohm load and Line 2 connected to the Analyzer / Receiver.
7. Analyzer / Receiver scanned from 150 kHz to 30MHz for emissions in each of the test modes.
8. During the above scans, the emissions were maximized by cable manipulation.
9. The test mode(s) were scanned during the preliminary test.

Then, the EUT configuration and cable configuration of the above highest emission level were recorded for reference of final testing.

14.4. FINAL PROCEDURE OF LINE CONDUCTED EMISSION TEST

1. EUT and support equipment was set up on the test bench as per step 2 of the preliminary test.
2. A scan was taken on both power lines, Line 1 and Line 2, recording at least the six highest emissions. Emission frequency and amplitude were recorded into a computer in which correction factors were used to calculate the emission level and compare reading to the applicable limit. If EUT emission level was less -2dB to the A.V. limit in Peak mode, then the emission signal was re-checked using Q.P and Average detector.
3. The test data of the worst case condition(s) was reported on the Summary Data page.

14.5. TEST RESULT OF LINE CONDUCTED EMISSION TEST

Note: The EUT is powered by battery.



APPENDIX A: PHOTOGRAPHS OF TEST SETUP

RADIATED EMISSION TEST SETUP BELOW 1GHZ

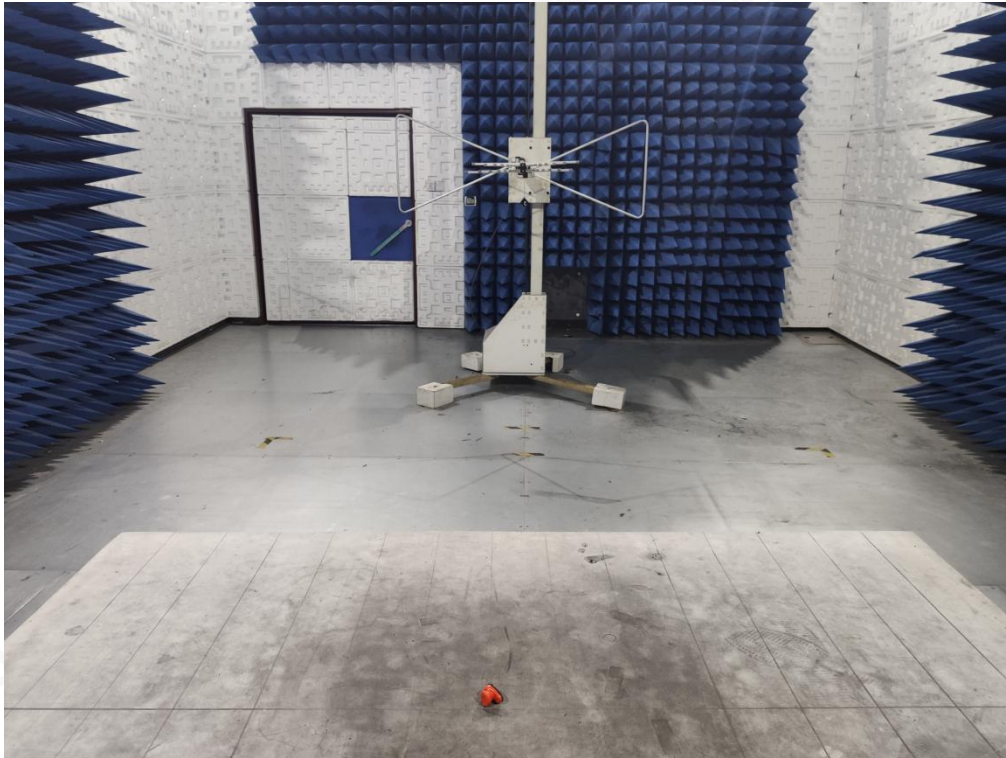

RADIATED EMISSION TEST SETUP ABOVE 1GHZ

