

Spurious Emission on Antenna Port
GSM/TM1/GSM1900
Channel 810 / 1909.8 MHz

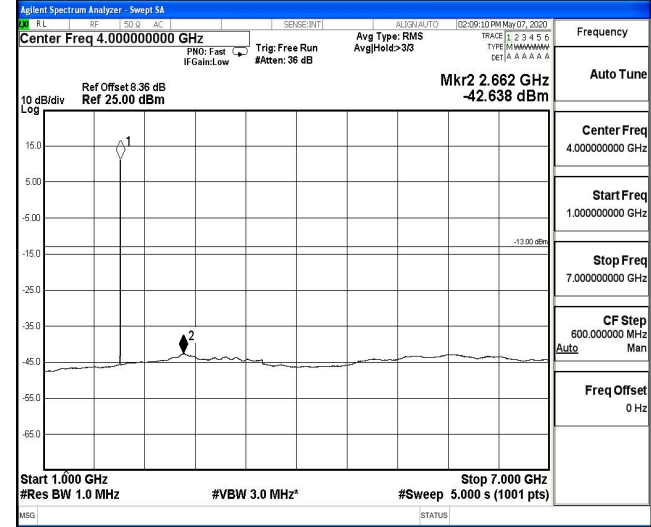

30 MHz – 1000 MHz

1 GHz – 7 GHz

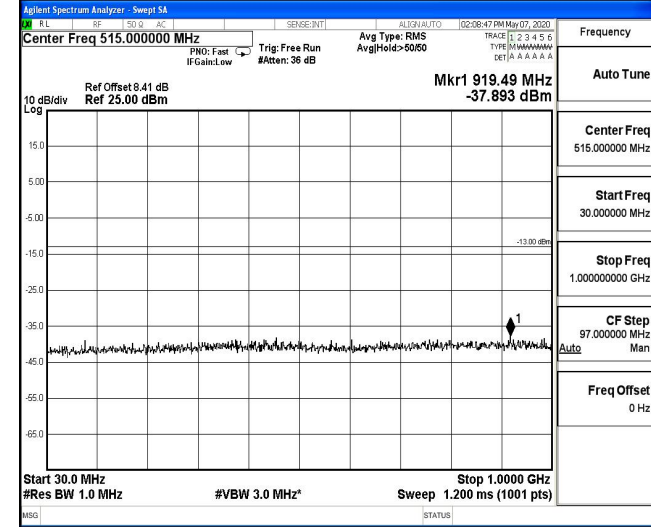
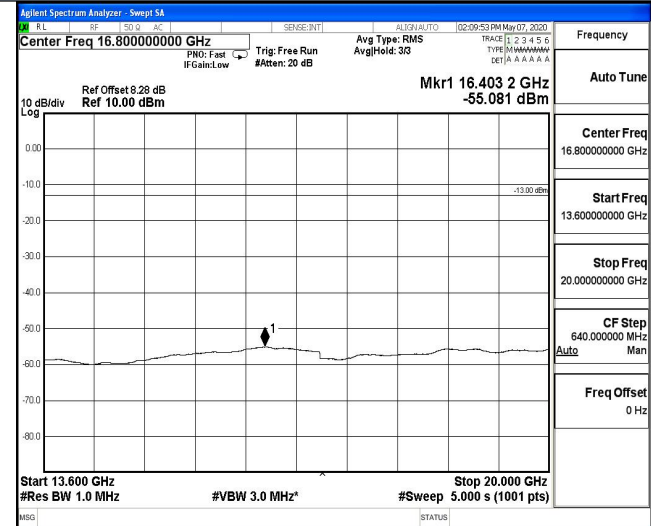
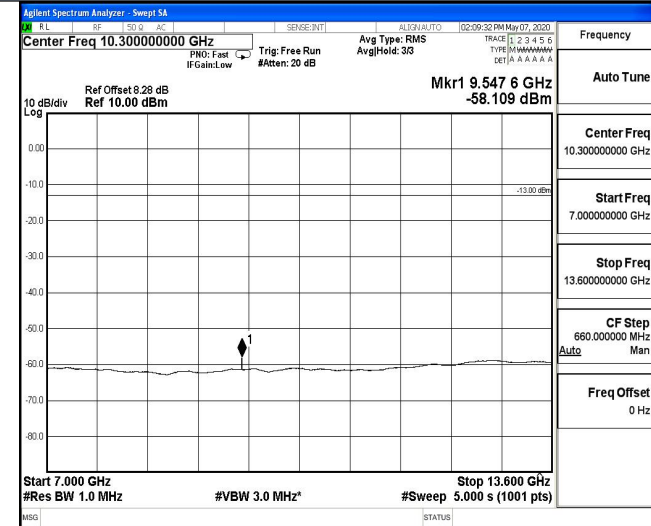

7 GHz – 13.6 GHz

13.6 GHz – 20 GHz

Spurious Emission on Antenna Port
GSM/TM3/EDGE1900
Channel 512 / 1850.2 MHz

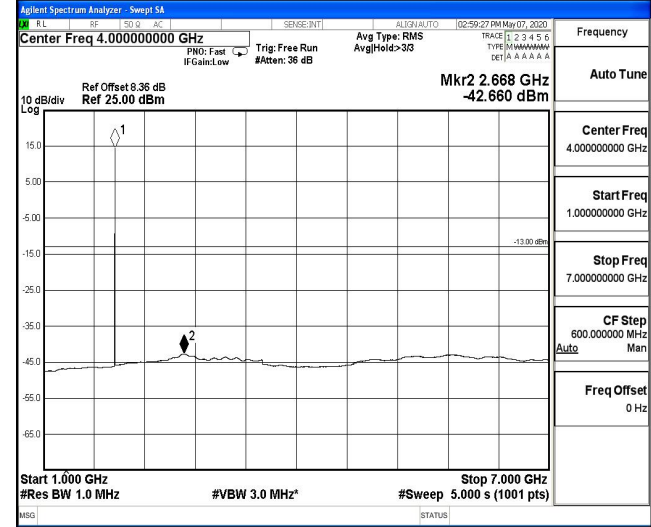
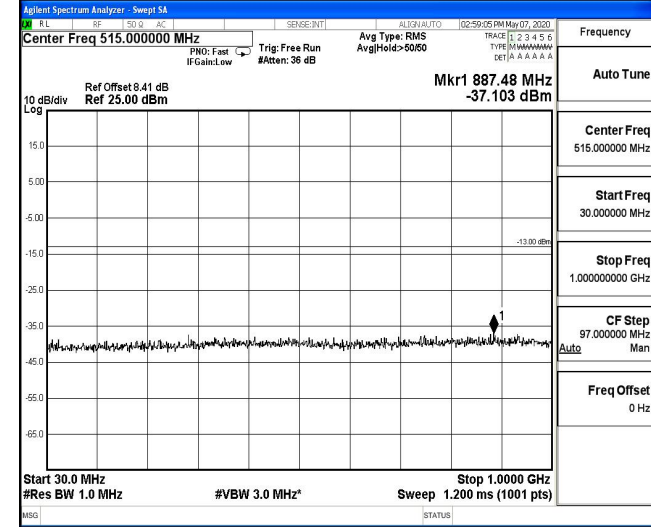

30 MHz – 1000 MHz

1 GHz – 7 GHz

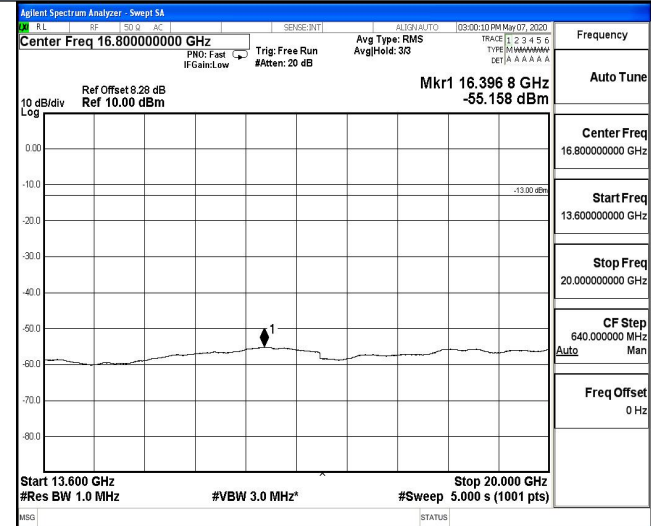
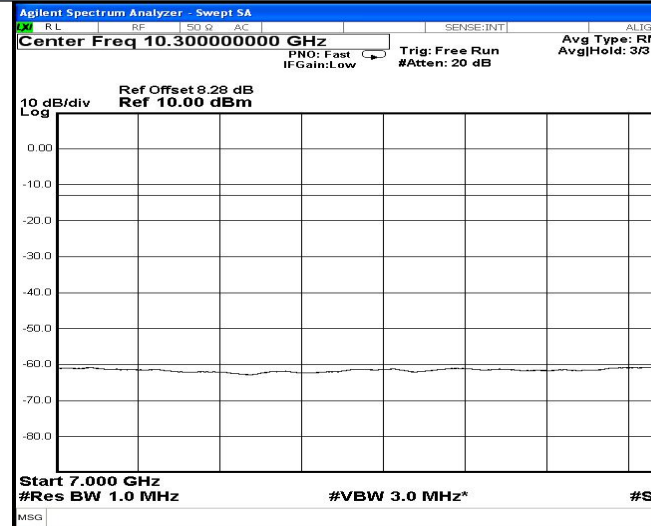

7 GHz – 13.6 GHz

13.6 GHz – 20 GHz

Spurious Emission on Antenna Port
GSM/TM3/EDGE1900
Channel 661 / 1880 MHz

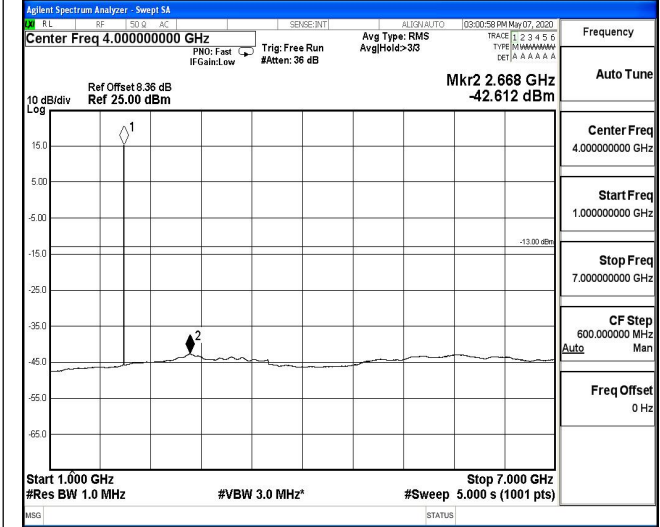
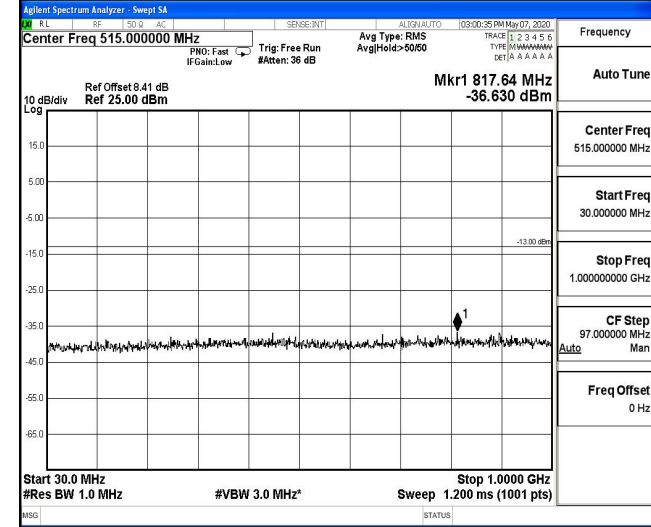

30 MHz – 1000 MHz

1 GHz – 7 GHz

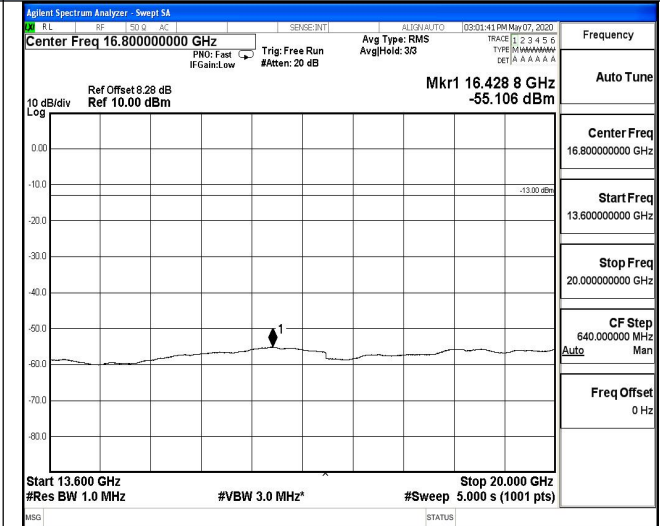
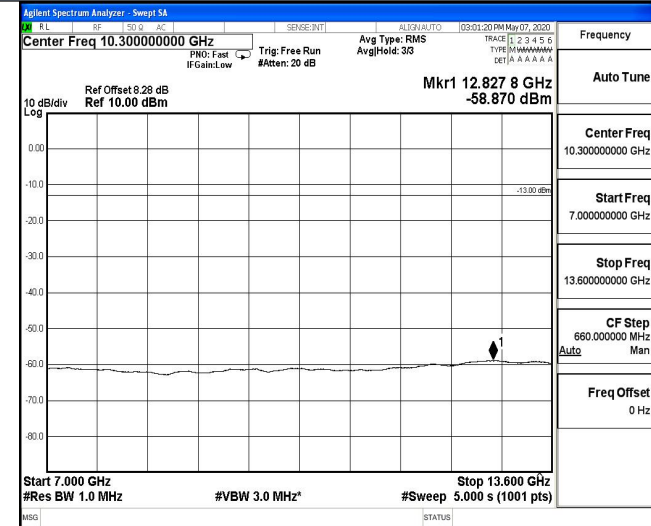

7 GHz – 13.6 GHz

13.6 GHz – 20 GHz

Spurious Emission on Antenna Port
GSM/TM3/EDGE1900
Channel 810 / 1909.8 MHz

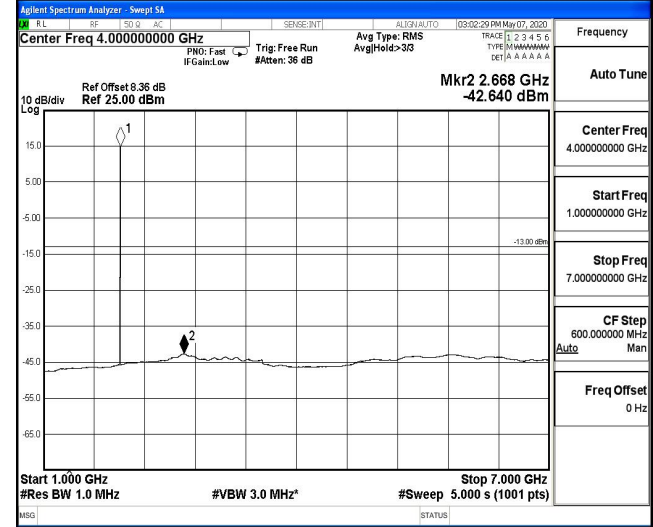
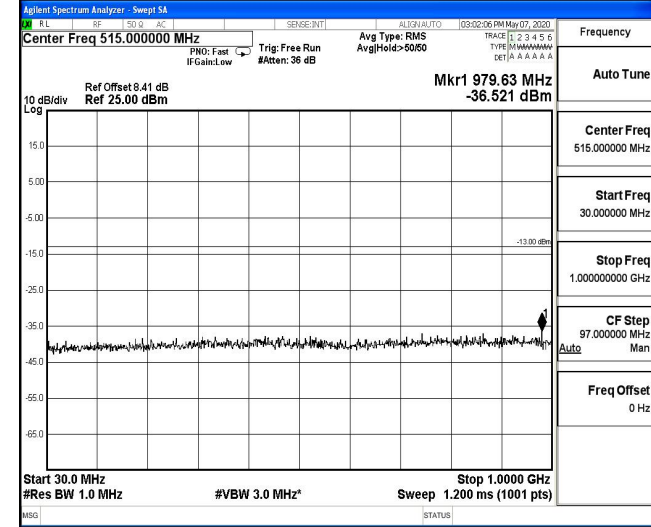

30 MHz – 1000 MHz

1 GHz – 7 GHz

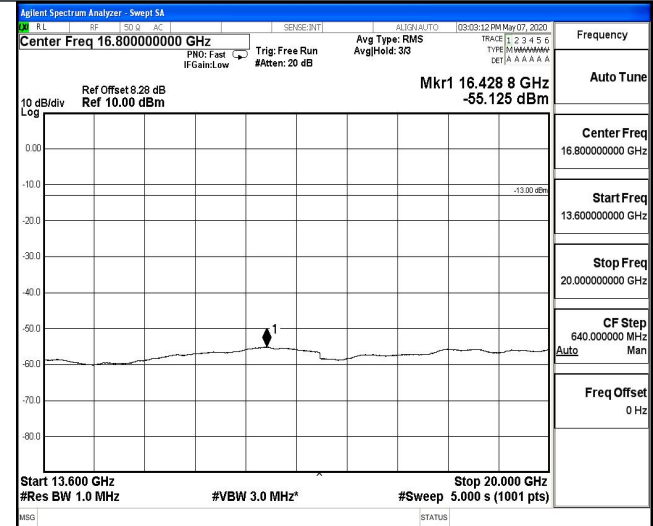
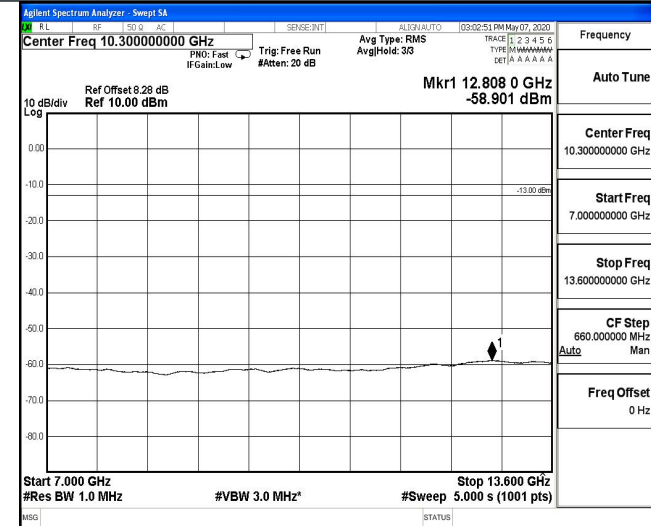

7 GHz – 13.6 GHz

13.6 GHz – 20 GHz

4.6 Frequency Stability Test

TEST APPLICABLE

1. According to FCC Part 2 Section 2.1055 (a)(1) and RSS-GEN, the frequency stability shall be measured with variation of ambient temperature from -30°C to +50°C centigrade.
2. According to FCC Part 2 Section 2.1055 (E) (2) and RSS-GEN, for battery powered equipment, the frequency stability shall be measured with reducing primary supply voltage to the battery operating end point, which is specified by the manufacture.
3. Vary primary supply voltage from 85 to 115 percent of the nominal value for other than hand carried voltage equipment and the end voltage point was 3.40V.

TEST PROCEDURE

In order to measure the carrier frequency under the condition of AFC lock, it is necessary to make measurements with the EUT in a "call mode". This is accomplished with the use of R&S CMU200 DIGITAL RADIO COMMUNICATION TESTER.

1. Measure the carrier frequency at room temperature;
2. Subject the EUT to overnight soak at -30°C;
3. With the EUT, powered via nominal voltage, connected to the CMU200 and in a simulated call on middle channel of PCS 1900 and GSM850, measure the carrier frequency. These measurements should be made within 2 minutes of Powering up the EUT, to prevent significant self-warming;
4. Repeat the above measurements at 10°C increments from -30°C to +50°C. Allow at least 0.5 hours at each temperature, unpowered, before making measurements;
5. Remeasure carrier frequency at room temperature with nominal voltage. Vary supply voltage from minimum voltage to maximum voltage, in 0.1Volt increments remeasuring carrier frequency at each voltage. Pause at nominal voltage for 0.5 hours unpowered, to allow any self-heating to stabilize, before continuing;
6. Subject the EUT to overnight soak at +50°C;
7. With the EUT, powered via nominal voltage, connected to the CMU200 and in a simulated call on the centre channel, measure the carrier frequency. These measurements should be made within 2 minutes of Powering up the EUT, to prevent significant self-warming;
8. Repeat the above measurements at 10°C increments from +50°C to -30°C. Allow at least 0.5 hours at each temperature, unpowered, before making measurements;
9. At all temperature levels hold the temperature to +/- 0.5°C during the measurement procedure;

TEST CONFIGURATION

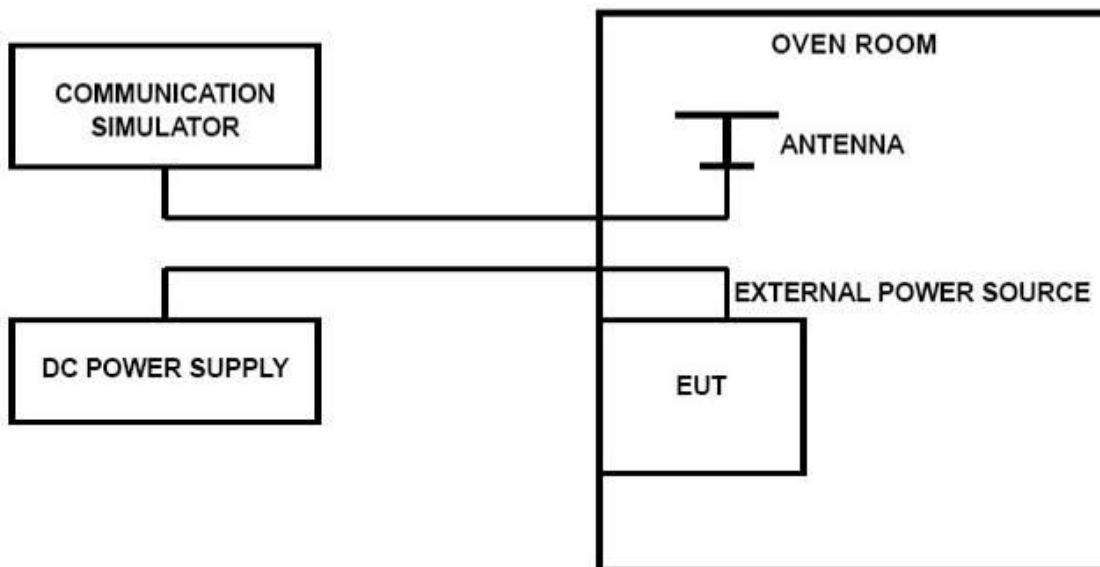

TEST LIMITS**For Hand carried battery powered equipment**

According to the JTC standard the frequency stability of the carrier shall be accurate to within 0.1 ppm of the received frequency from the base station. This accuracy is sufficient to meet Sec. 24.235, Frequency Stability. The frequency stability shall be sufficient to ensure that the fundamental emission stays within the authorized frequency block. As this transceiver is considered "Hand carried, battery powered equipment" Section 2.1055(d)(2) applies. This requires that the lower voltage for frequency stability testing be specified by the manufacturer. This transceiver is specified to operate with an input voltage of between 3.40VDC and 4.20VDC, with a nominal voltage of 3.80DC. Operation above or below these voltage limits is prohibited by transceiver software in order to prevent improper operation as well as to protect components from overstress. These voltages represent a tolerance of -10 % and +12.5 %. For the purposes of measuring frequency stability these voltage limits are to be used.

For equipment powered by primary supply voltage

According to the JTC standard the frequency stability of the carrier shall be accurate to within 0.1 ppm of the received frequency from the base station. This accuracy is sufficient to meet Sec. 24.235, Frequency Stability. The frequency stability shall be sufficient to ensure that the fundamental emission stays within the authorized frequency block. For this EUT section 2.1055(d)(1) applies. This requires varying primary supply voltage from 85 to 115 percent of the nominal value for other than hand carried battery equipment.

TEST RESULTS

GSM/TM1/GSM850					
DC Power	Temperature (°C)	Frequency error(Hz)	Frequency error(ppm)	Limit (ppm)	Verdict
3.15	25	-49	-0.059	2.50	PASS
3.85	25	27	0.033	2.50	PASS
4.43	25	33	0.040	2.50	PASS
3.85	-30	-47	-0.057	2.50	PASS
3.85	-20	-37	-0.045	2.50	PASS
3.85	-10	4	0.005	2.50	PASS
3.85	0	-44	-0.053	2.50	PASS
3.85	10	-7	-0.008	2.50	PASS
3.85	20	-23	-0.028	2.50	PASS
3.85	30	12	0.015	2.50	PASS
3.85	40	47	0.057	2.50	PASS
3.85	50	6	0.007	2.50	PASS

GSM/TM3/EDGE850					
DC Power	Temperature (°C)	Frequency error(Hz)	Frequency error(ppm)	Limit (ppm)	Verdict
3.15	25	13	0.016	2.50	PASS
3.85	25	40	0.049	2.50	PASS
4.43	25	30	0.036	2.50	PASS
3.85	-30	36	0.044	2.50	PASS
3.85	-20	-35	-0.042	2.50	PASS
3.85	-10	1	0.001	2.50	PASS
3.85	0	-22	-0.027	2.50	PASS
3.85	10	12	0.015	2.50	PASS
3.85	20	-12	-0.015	2.50	PASS
3.85	30	13	0.016	2.50	PASS
3.85	40	47	0.057	2.50	PASS
3.85	50	6	0.007	2.50	PASS

GSM/TM1/GSM1900					
DC Power	Temperature (°C)	Frequency error(Hz)	Frequency error(ppm)	Limit (ppm)	Verdict
3.15	25	-2	-0.002	2.50	PASS
3.85	25	49	0.059	2.50	PASS
4.43	25	7	0.008	2.50	PASS
3.85	-30	50	0.061	2.50	PASS
3.85	-20	-38	-0.046	2.50	PASS
3.85	-10	39	0.047	2.50	PASS
3.85	0	-39	-0.047	2.50	PASS
3.85	10	19	0.023	2.50	PASS
3.85	20	49	0.059	2.50	PASS
3.85	30	26	0.032	2.50	PASS
3.85	40	-10	-0.012	2.50	PASS
3.85	50	18	0.022	2.50	PASS

GSM/TM3/EDGE1900					
DC Power	Temperature (°C)	Frequency error(Hz)	Frequency error(ppm)	Limit (ppm)	Verdict
3.15	25	81	0.046	2.50	PASS
3.85	25	98	0.056	2.50	PASS
4.43	25	65	0.037	2.50	PASS
3.85	-30	74	0.042	2.50	PASS
3.85	-20	49	0.028	2.50	PASS
3.85	-10	43	0.025	2.50	PASS
3.85	0	26	0.015	2.50	PASS
3.85	10	56	0.032	2.50	PASS
3.85	20	92	0.053	2.50	PASS
3.85	30	47	0.027	2.50	PASS
3.85	40	19	0.011	2.50	PASS
3.85	50	30	0.017	2.50	PASS

4.7 Peak-to-Average Ratio (PAR)

LIMIT

The Peak-to-Average Ratio (PAR) of the transmission may not exceed 13 dB.

TEST CONFIGURATION

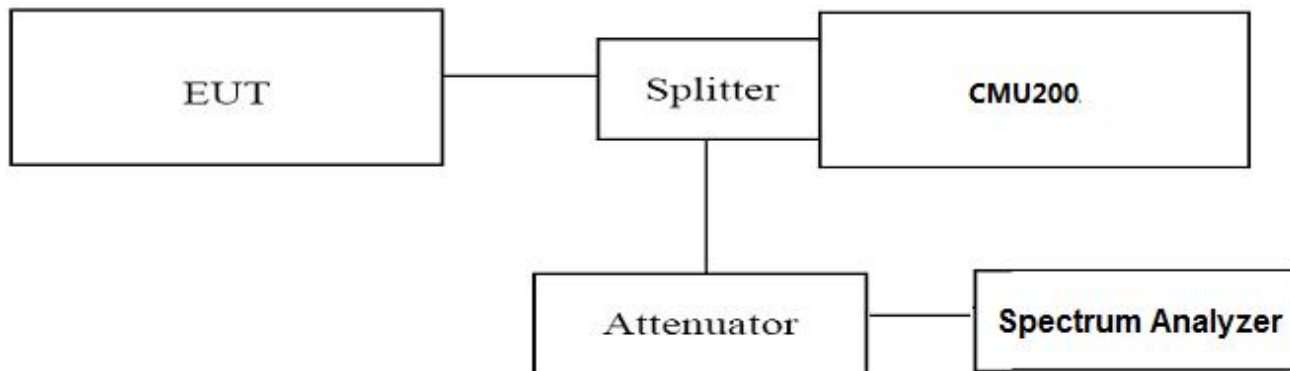

TEST PROCEDURE

Use spectrum to measure the total peak power and record as P_{Pk}. Use spectrum to measure the total average power and record as P_{Avg}. Both the peak and average power levels must be expressed in the same logarithmic units (e.g., dBm).

Determine the PAPR from:

$$PAPR (dB) = P_{Pk} (dBm) - P_{Avg} (dBm).$$

TEST RESULTS

Test Mode	Channel	Frequency (MHz)	PAPR Value (dB)	Limits (dB)	Verdict
GSM/TM1/GSM850	128	824.2	2.60	13.0	PASS
	190	836.6	2.62	13.0	
	251	848.8	2.59	13.0	
GSM/TM3/EDGE850	128	824.2	5.50	13.0	PASS
	190	836.6	5.56	13.0	
	251	848.8	2.60	13.0	
GSM/TM1/GSM1900	512	1850.2	2.59	13.0	PASS
	661	1880.0	2.59	13.0	
	810	1909.8	2.60	13.0	
GSM/TM3/EDGE1900	512	1850.2	2.59	13.0	PASS
	661	1880.0	2.60	13.0	
	810	1909.8	2.60	13.0	

Peak-to-Average Ratio (PAR)

GSM/TM1/GSM850

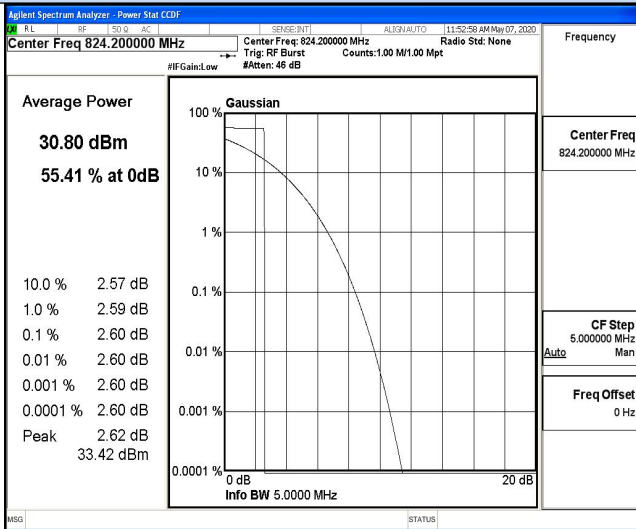

GSM/TM3/EDGE850

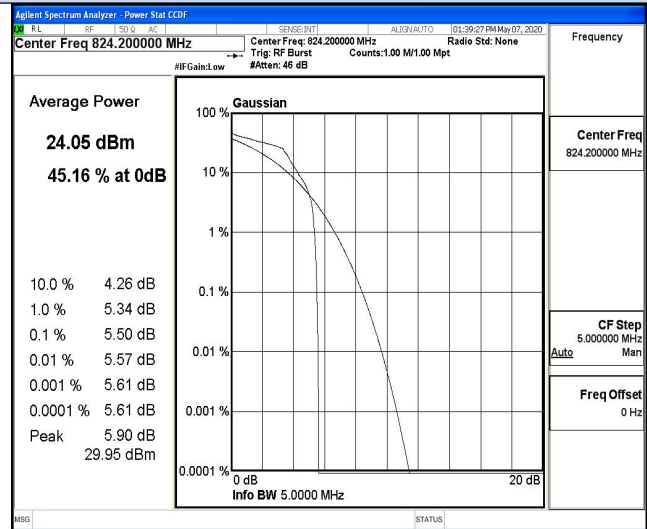

Channel 128/ 824.2 MHz

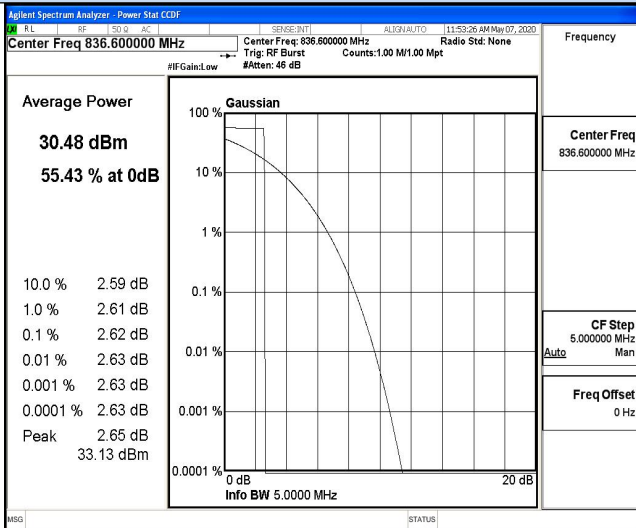

Channel 128/ 824.2 MHz

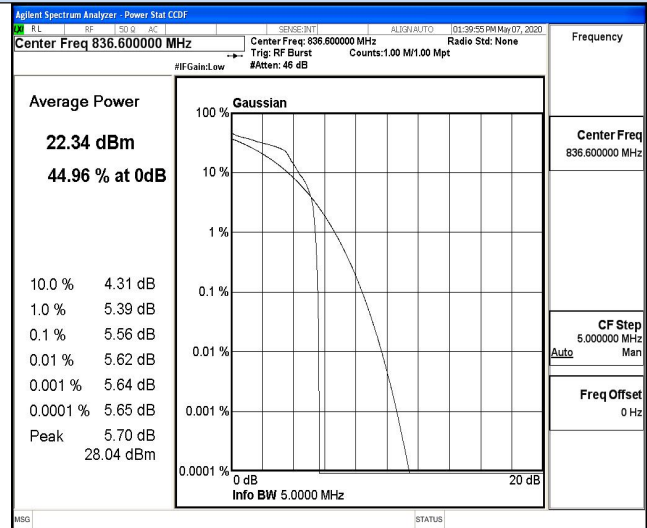

Channel 190/ 836.6 MHz

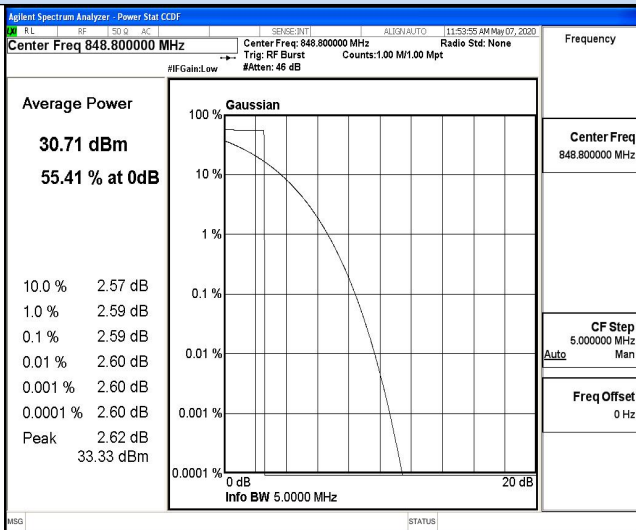

Channel 190/ 836.6 MHz

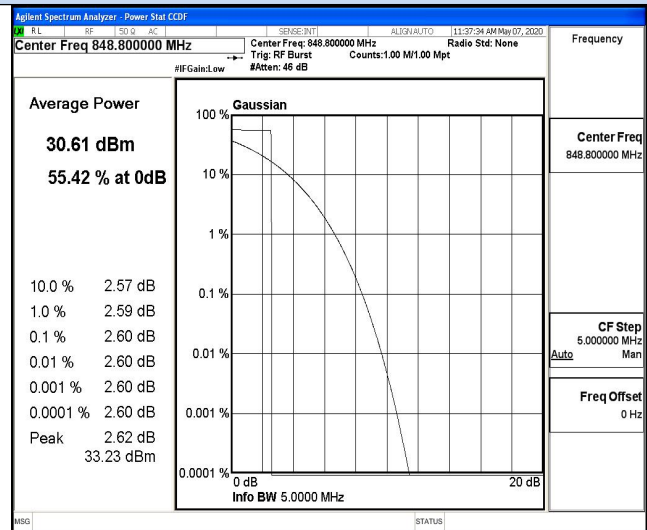

Channel 251/ 848.8 MHz

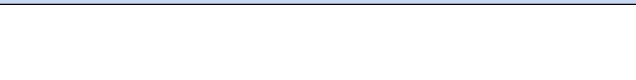

Channel 251/ 848.8 MHz

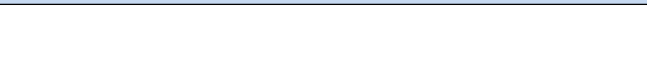

Peak-to-Average Ratio (PAR)

GSM/TM1/GSM1900

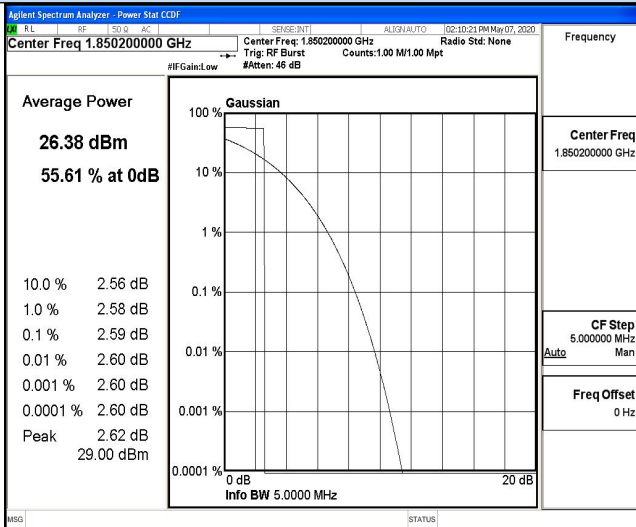

GSM/TM3/EDGE1900

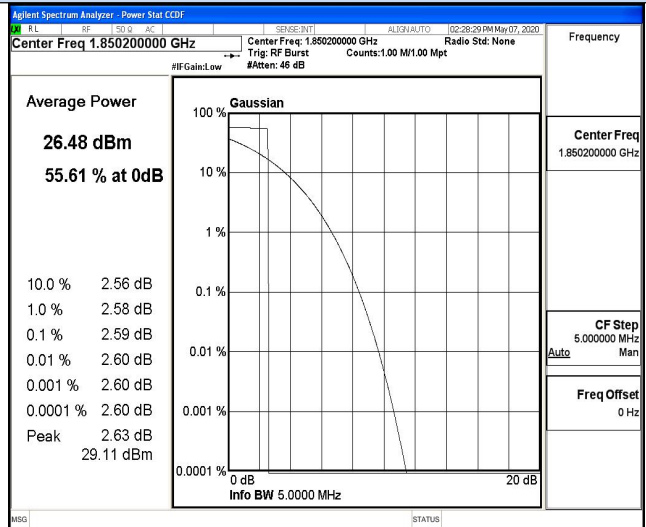

Channel 512/ 1850.2 MHz

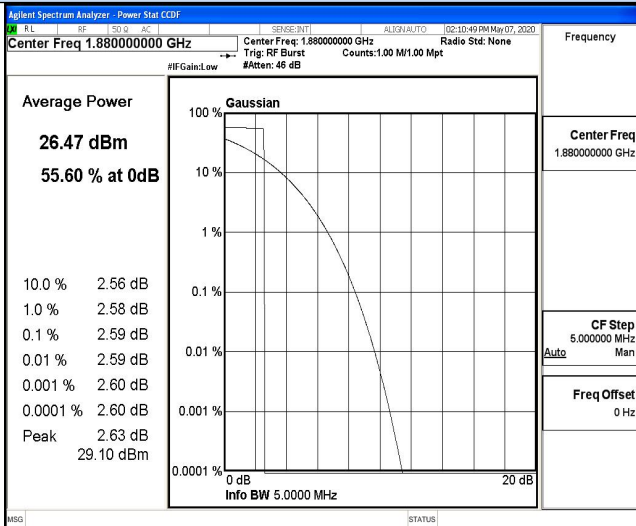

Channel 512/ 1850.2 MHz

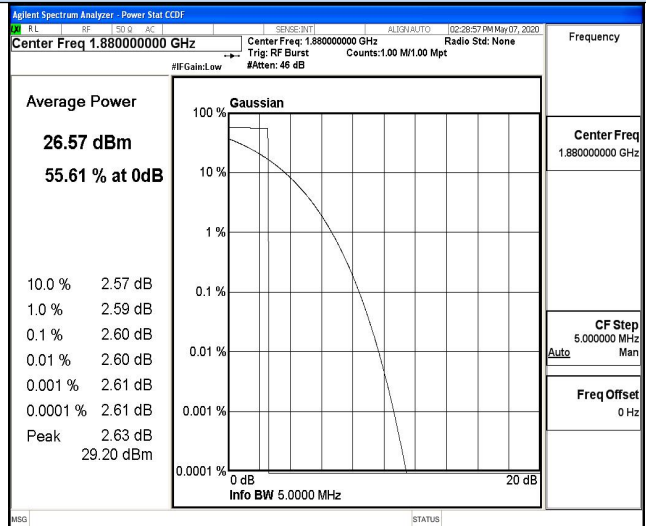

Channel 661/ 1880 MHz

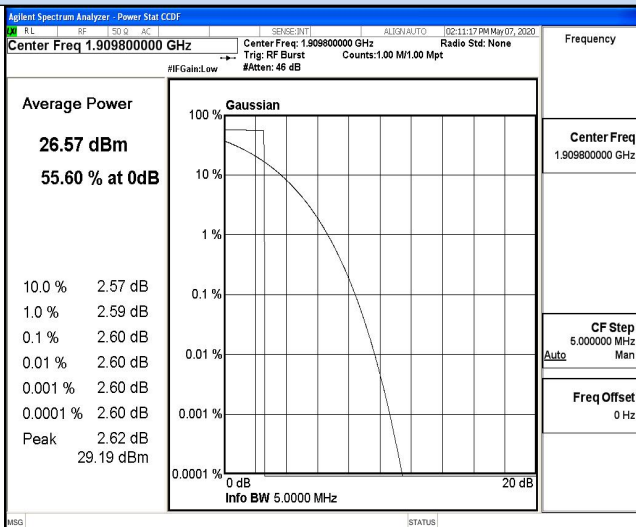

Channel 661/ 1880 MHz

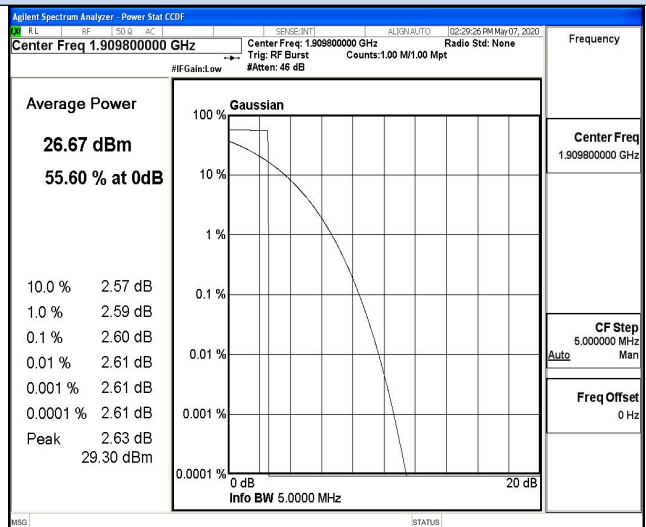

Channel 810/ 1909.8 MHz

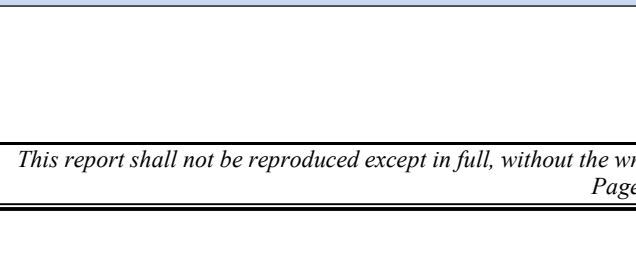

Channel 810/ 1909.8 MHz

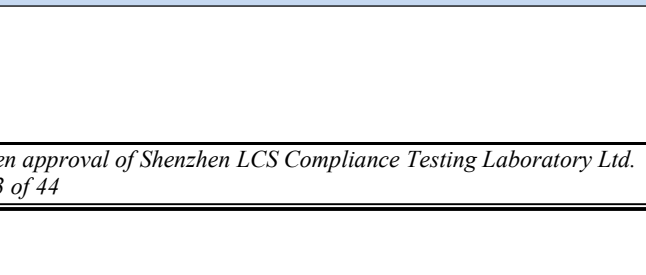

5 TEST SETUP PHOTOGRAPHS OF EUT

Please refer to separated files for Test Setup Photos of the EUT.

6 EXTERIOR PHOTOGRAPHS OF THE EUT

Please refer to separated files for External Photos of the EUT.

7 INTERIOR PHOTOGRAPHS OF THE EUT

Please refer to separated files for Internal Photos of the EUT.

.....**End of Report**.....