



## SAR REFERENCE DIPOLE CALIBRATION REPORT

Ref: ACR.287.8.14.SATU.A

## 7.3 BODY LIQUID MEASUREMENT

Frequency MHz	Relative permittivity ( $\epsilon_r'$ )		Conductivity ( $\sigma$ ) S/m	
	required	measured	required	measured
150	61.9 $\pm$ 5 %		0.80 $\pm$ 5 %	
300	58.2 $\pm$ 5 %		0.92 $\pm$ 5 %	
450	56.7 $\pm$ 5 %		0.94 $\pm$ 5 %	
750	55.5 $\pm$ 5 %		0.96 $\pm$ 5 %	
835	55.2 $\pm$ 5 %		0.97 $\pm$ 5 %	
900	55.0 $\pm$ 5 %		1.05 $\pm$ 5 %	
915	55.0 $\pm$ 5 %		1.06 $\pm$ 5 %	
1450	54.0 $\pm$ 5 %		1.30 $\pm$ 5 %	
1610	53.8 $\pm$ 5 %		1.40 $\pm$ 5 %	
1800	53.3 $\pm$ 5 %		1.52 $\pm$ 5 %	
1900	53.3 $\pm$ 5 %		1.52 $\pm$ 5 %	
2000	53.3 $\pm$ 5 %		1.52 $\pm$ 5 %	
2100	53.2 $\pm$ 5 %		1.62 $\pm$ 5 %	
2450	52.7 $\pm$ 5 %	PASS	1.95 $\pm$ 5 %	PASS
2600	52.5 $\pm$ 5 %		2.16 $\pm$ 5 %	
3000	52.0 $\pm$ 5 %		2.73 $\pm$ 5 %	
3500	51.3 $\pm$ 5 %		3.31 $\pm$ 5 %	
5200	49.0 $\pm$ 10 %		5.30 $\pm$ 10 %	
5300	48.9 $\pm$ 10 %		5.42 $\pm$ 10 %	
5400	48.7 $\pm$ 10 %		5.53 $\pm$ 10 %	
5500	48.6 $\pm$ 10 %		5.65 $\pm$ 10 %	
5600	48.5 $\pm$ 10 %		5.77 $\pm$ 10 %	
5800	48.2 $\pm$ 10 %		6.00 $\pm$ 10 %	

## 7.4 SAR MEASUREMENT RESULT WITH BODY LIQUID

Software	OPENSAR V4
Phantom	SN 20/09 SAM71
Probe	SN 18/11 EPG122
Liquid	Body Liquid Values: $\epsilon_r'$ : 53.0 sigma : 1.93
Distance between dipole center and liquid	10.0 mm
Area scan resolution	dx=8mm/dy=8mm
Zoon Scan Resolution	dx=8mm/dy=8m/dz=5mm
Frequency	2450 MHz
Input power	20 dBm
Liquid Temperature	21 °C
Lab Temperature	21 °C
Lab Humidity	45 %

Page: 9/11

*This document shall not be reproduced, except in full or in part, without the written approval of SATIMO.  
The information contained herein is to be used only for the purpose for which it is submitted and is not to be released in whole or part without written approval of SATIMO.*



SAR REFERENCE DIPOLE CALIBRATION REPORT

Ref: ACR.287.8.14.SATU.A

Frequency MHz	1 g SAR (W/kg/W)	10 g SAR (W/kg/W)
	measured	measured
2450	54.65 (5.46)	24.58 (2.46)

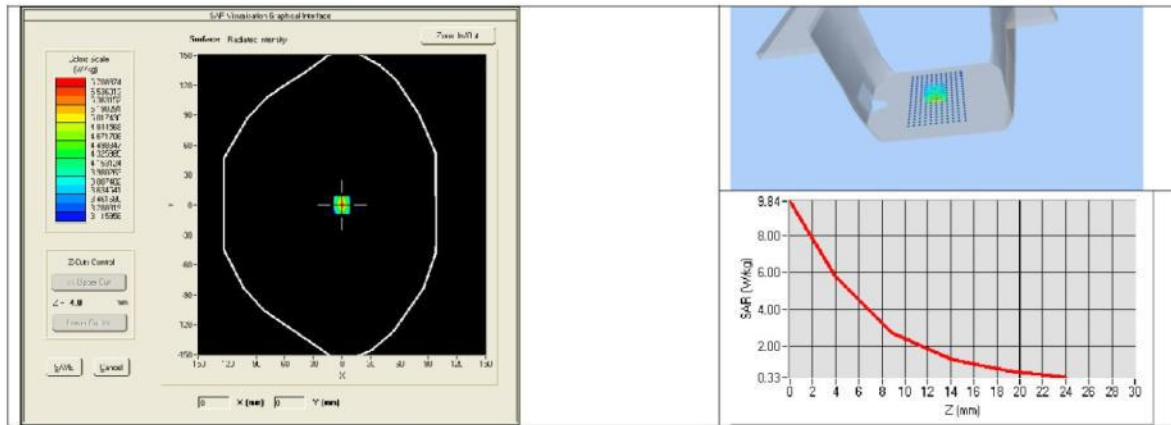

*This document shall not be reproduced, except in full or in part, without the written approval of SATIMO. The information contained herein is to be used only for the purpose for which it is submitted and is not to be released in whole or part without written approval of SATIMO.*



## SAR REFERENCE DIPOLE CALIBRATION REPORT

Ref: ACR.287.8.14.SATU.A

## 8 LIST OF EQUIPMENT

Equipment Summary Sheet				
Equipment Description	Manufacturer / Model	Identification No.	Current Calibration Date	Next Calibration Date
SAM Phantom	Satimo	SN-20/09-SAM71	Validated. No cal required.	Validated. No cal required.
COMOSAR Test Bench	Version 3	NA	Validated. No cal required.	Validated. No cal required.
Network Analyzer	Rhode & Schwarz ZVA	SN100132	02/2016	02/2019
Calipers	Carrera	CALIPER-01	12/2016	12/2019
Reference Probe	Satimo	EPG122 SN 18/11	10/2018	10/2019
Multimeter	Keithley 2000	1188656	12/2016	12/2019
Signal Generator	Agilent E4438C	MY49070581	12/2016	12/2019
Amplifier	Aethercomm	SN 046	Characterized prior to test. No cal required.	Characterized prior to test. No cal required.
Power Meter	HP E4418A	US38261498	12/2016	12/2019
Power Sensor	HP ECP-E26A	US37181460	12/2016	12/2019
Directional Coupler	Narda 4216-20	01386	Characterized prior to test. No cal required.	Characterized prior to test. No cal required.
Temperature and Humidity Sensor	Control Company	11-661-9	8/2016	8/2019

Page: 11/11

*This document shall not be reproduced, except in full or in part, without the written approval of SATIMO. The information contained herein is to be used only for the purpose for which it is submitted and is not to be released in whole or part without written approval of SATIMO.*

## 5.7 SID5-6G Dipole Calibration Certificate



### SAR Reference Waveguide Calibration Report

Ref : ACR.273.5.18.SATU.A

#### SHENZHEN LCS COMPLIANCE TESTING LABORATORY LTD.

1F., XINGYUAN INDUSTRIAL PARK, TONGDA  
ROAD, BAO'AN BLVD BAO'AN DISTRICT,  
SHENZHEN, GUANGDONG, CHINA  
MVG COMOSAR  
REFERENCE WAVEGUIDE

FREQUENCY: 5000-6000 MHZ

SERIAL NO.: SN 49/16 WGA 43

Calibrated at MVG US

2105 Barrett Park Dr. - Kennesaw, GA 30144



Calibration Date: 09/24/2018

#### Summary:

This document presents the method and results from an accredited SAR reference waveguide calibration performed in MVG USA using the COMOSAR test bench. All calibration results are traceable to national metrology institutions.



SAR REFERENCE WAVEGUIDE CALIBRATION REPORT

Ref: ACR.273.5.18.SATU.A

	<i>Name</i>	<i>Function</i>	<i>Date</i>	<i>Signature</i>
<i>Prepared by :</i>	Jérôme LUC	Product Manager	09/30/2018	<i>JL</i>
<i>Checked by :</i>	Jérôme LUC	Product Manager	09/30/2018	<i>JL</i>
<i>Approved by :</i>	Kim RUTKOWSKI	Quality Manager	09/30/2018	<i>Kim Rutkowski</i>

	<i>Customer Name</i>
<i>Distribution :</i>	Shenzhen LCS Compliance Testing Laboratory Ltd.

<i>Issue</i>	<i>Date</i>	<i>Modifications</i>
A	09/30/2018	Initial release

*This document shall not be reproduced, except in full or in part, without the written approval of MVG. The information contained herein is to be used only for the purpose for which it is submitted and is not to be released in whole or part without written approval of MVG.*



## SAR REFERENCE WAVEGUIDE CALIBRATION REPORT

Ref: ACR.273.5.18.SATU.A

## TABLE OF CONTENTS

1	Introduction.....	4
2	Device Under Test .....	4
3	Product Description .....	4
3.1	General Information .....	4
4	Measurement Method .....	4
4.1	Return Loss Requirements .....	4
4.2	Mechanical Requirements .....	4
5	Measurement Uncertainty.....	5
5.1	Return Loss .....	5
5.2	Dimension Measurement .....	5
5.3	Validation Measurement .....	5
6	Calibration Measurement Results.....	5
6.1	Return Loss .....	5
6.2	Mechanical Dimensions .....	6
7	Validation measurement .....	7
7.1	Head Liquid Measurement .....	7
7.2	Measurement Result .....	7
7.3	Body Measurement Result .....	10
8	List of Equipment .....	13

Page: 3/13

*This document shall not be reproduced, except in full or in part, without the written approval of MVG.  
The information contained herein is to be used only for the purpose for which it is submitted and is not to be released in whole or part without written approval of MVG.*



## SAR REFERENCE WAVEGUIDE CALIBRATION REPORT

Ref: ACR.273.5.18.SATU.A

## 1 INTRODUCTION

This document contains a summary of the requirements set forth by the IEEE 1528 and CEI/IEC 62209 standards for reference waveguides used for SAR measurement system validations and the measurements that were performed to verify that the product complies with the fore mentioned standards.

## 2 DEVICE UNDER TEST

Device Under Test	
Device Type	COMOSAR 5000-6000 MHz REFERENCE WAVEGUIDE
Manufacturer	MVG
Model	SWG5500
Serial Number	SN 49/16 WGA 43
Product Condition (new / used)	Used

A yearly calibration interval is recommended.

## 3 PRODUCT DESCRIPTION

### 3.1 GENERAL INFORMATION

MVG's COMOSAR Validation Waveguides are built in accordance to the IEEE 1528 and CEI/IEC 62209 standards.

## 4 MEASUREMENT METHOD

The IEEE 1528 and CEI/IEC 62209 standards provide requirements for reference waveguides used for system validation measurements. The following measurements were performed to verify that the product complies with the fore mentioned standards.

### 4.1 RETURN LOSS REQUIREMENTS

The waveguide used for SAR system validation measurements and checks must have a return loss of -8 dB or better. The return loss measurement shall be performed with matching layer placed in the open end of the waveguide, with the waveguide and matching layer in direct contact with the phantom shell as outlined in the fore mentioned standards.

### 4.2 MECHANICAL REQUIREMENTS

The IEEE 1528 and CEI/IEC 62209 standards specify the mechanical dimensions of the validation waveguide, the specified dimensions are as shown in Section 6.2. Figure 1 shows how the dimensions relate to the physical construction of the waveguide.

Page: 4/13

*This document shall not be reproduced, except in full or in part, without the written approval of MVG.  
The information contained herein is to be used only for the purpose for which it is submitted and is not to be released in whole or part without written approval of MVG.*



## SAR REFERENCE WAVEGUIDE CALIBRATION REPORT

Ref: ACR.273.5.18.SATU.A

## 5 MEASUREMENT UNCERTAINTY

All uncertainties listed below represent an expanded uncertainty expressed at approximately the 95% confidence level using a coverage factor of  $k=2$ , traceable to the Internationally Accepted Guides to Measurement Uncertainty.

### 5.1 RETURN LOSS

The following uncertainties apply to the return loss measurement:

Frequency band	Expanded Uncertainty on Return Loss
400-6000MHz	0.1 dB

### 5.2 DIMENSION MEASUREMENT

The following uncertainties apply to the dimension measurements:

Length (mm)	Expanded Uncertainty on Length
3 - 300	0.05 mm

### 5.3 VALIDATION MEASUREMENT

The guidelines outlined in the IEEE 1528 and CEI/IEC 62209 standards were followed to generate the measurement uncertainty for validation measurements.

Scan Volume	Expanded Uncertainty
1 g	20.3 %
10 g	20.1 %

## 6 CALIBRATION MEASUREMENT RESULTS

### 6.1 RETURN LOSS IN HEAD LIQUID

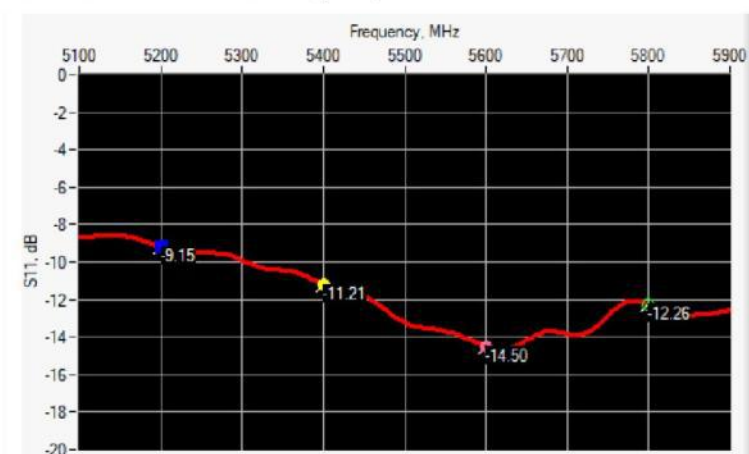

Page: 5/13

*This document shall not be reproduced, except in full or in part, without the written approval of MVG. The information contained herein is to be used only for the purpose for which it is submitted and is not to be released in whole or part without written approval of MVG.*





SAR REFERENCE WAVEGUIDE CALIBRATION REPORT

Ref: ACR.273.5.18.SATU.A

Frequency (MHz)	Return Loss (dB)	Requirement (dB)	Impedance
5200	-9.15	-8	20.57 Ω + 11.55 jΩ
5400	-11.21	-8	75.27 Ω + 4.08 jΩ
5600	-14.50	-8	33.91 Ω - 8.72 jΩ
5800	-12.26	-8	53.07 Ω + 23.41 jΩ

6.2 RETURN LOSS IN BODY LIQUID

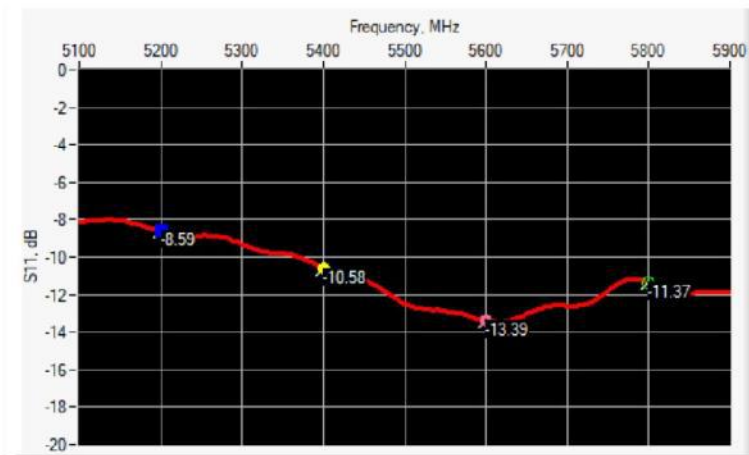

Frequency (MHz)	Return Loss (dB)	Requirement (dB)	Impedance
5200	-8.59	-8	19.38 Ω + 13.50 jΩ
5400	-10.58	-8	77.13 Ω + 1.81 jΩ
5600	-13.39	-8	30.95 Ω - 7.75 jΩ
5800	-11.37	-8	54.79 Ω + 25.47 jΩ

6.3 MECHANICAL DIMENSIONS

Frequency (MHz)	L (mm)		W (mm)		L <sub>r</sub> (mm)		W <sub>r</sub> (mm)		T (mm)	
	Required	Measured	Required	Measured	Required	Measured	Required	Measured	Required	Measured
5200	40.39 ± 0.13	PASS	20.19 ± 0.13	PASS	81.03 ± 0.13	PASS	61.98 ± 0.13	PASS	5.3*	PASS
5800	40.39 ± 0.13	PASS	20.19 ± 0.13	PASS	81.03 ± 0.13	PASS	61.98 ± 0.13	PASS	4.3*	PASS

\* The tolerance for the matching layer is included in the return loss measurement.

This document shall not be reproduced, except in full or in part, without the written approval of MVG. The information contained herein is to be used only for the purpose for which it is submitted and is not to be released in whole or part without written approval of MVG.



## SAR REFERENCE WAVEGUIDE CALIBRATION REPORT

Ref: ACR.273.5.18.SATU.A

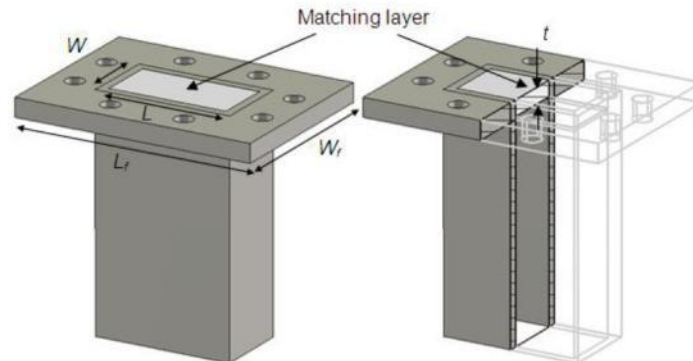

Figure 1: Validation Waveguide Dimensions

## 7 VALIDATION MEASUREMENT

The IEEE Std. 1528 and CEI/IEC 62209 standards state that the system validation measurements must be performed using a reference waveguide meeting the fore mentioned return loss and mechanical dimension requirements. The validation measurement must be performed with the matching layer placed in the open end of the waveguide, with the waveguide and matching layer in direct contact with the phantom shell.

### 7.1 HEAD LIQUID MEASUREMENT

Frequency MHz	Relative permittivity ( $\epsilon_r'$ )		Conductivity ( $\sigma$ ) S/m	
	required	measured	required	measured
5000	36.2 $\pm$ 10 %		4.45 $\pm$ 10 %	
5100	36.1 $\pm$ 10 %		4.56 $\pm$ 10 %	
5200	36.0 $\pm$ 10 %	PASS	4.66 $\pm$ 10 %	PASS
5300	35.9 $\pm$ 10 %		4.76 $\pm$ 10 %	
5400	35.8 $\pm$ 10 %	PASS	4.86 $\pm$ 10 %	PASS
5500	35.6 $\pm$ 10 %		4.97 $\pm$ 10 %	
5600	35.5 $\pm$ 10 %	PASS	5.07 $\pm$ 10 %	PASS
5700	35.4 $\pm$ 10 %		5.17 $\pm$ 10 %	
5800	35.3 $\pm$ 10 %	PASS	5.27 $\pm$ 10 %	PASS
5900	35.2 $\pm$ 10 %		5.38 $\pm$ 10 %	
6000	35.1 $\pm$ 10 %		5.48 $\pm$ 10 %	

### 7.2 SAR MEASUREMENT RESULT WITH HEAD LIQUID

At those frequencies, the target SAR value can not be generic. Hereunder is the target SAR value defined by MVG, within the uncertainty for the system validation. All SAR values are normalized to 1 W net power. In bracket, the measured SAR is given with the used input power.

Page: 7/13

*This document shall not be reproduced, except in full or in part, without the written approval of MVG.  
The information contained herein is to be used only for the purpose for which it is submitted and is not to be released in whole or part without written approval of MVG.*



SAR REFERENCE WAVEGUIDE CALIBRATION REPORT

Ref: ACR.273.5.18.SATU.A

Software	OPENSAR V4
Phantom	SN 20/09 SAM71
Probe	SN 18/11 EPG122
Liquid	Head Liquid Values 5200 MHz: eps' :35.64 sigma : 4.67 Head Liquid Values 5400 MHz: eps' :36.44 sigma : 4.87 Head Liquid Values 5600 MHz: eps' :36.66 sigma : 5.17 Head Liquid Values 5800 MHz: eps' :35.31 sigma : 5.31
Distance between dipole waveguide and liquid	0 mm
Area scan resolution	dx=8mm/dy=8mm
Zoon Scan Resolution	dx=4mm/dy=4m/dz=2mm
Frequency	5200 MHz 5400 MHz 5600 MHz 5800 MHz
Input power	20 dBm
Liquid Temperature	21 °C
Lab Temperature	21 °C
Lab Humidity	45 %

Frequency (MHz)	1 g SAR (W/kg)		10 g SAR (W/kg)	
	required	measured	required	measured
5200	159.00	165.77 (16.58)	56.90	57.20 (5.72)
5400	166.40	173.20 (17.32)	58.43	59.22 (5.92)
5600	173.80	179.61 (17.96)	59.97	60.98 (6.10)
5800	181.20	186.77 (18.68)	61.50	62.84 (6.28)

SAR MEASUREMENT PLOTS @ 5200 MHz

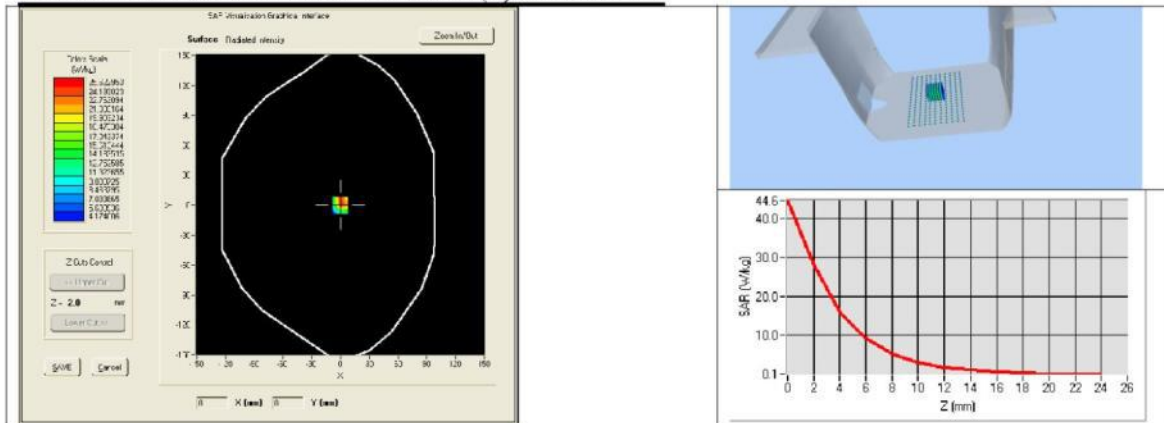

This document shall not be reproduced, except in full or in part, without the written approval of MVG. The information contained herein is to be used only for the purpose for which it is submitted and is not to be released in whole or part without written approval of MVG.



SAR REFERENCE WAVEGUIDE CALIBRATION REPORT

Ref: ACR.273.5.18.SATU.A

SAR MEASUREMENT PLOTS @ 5400 MHz

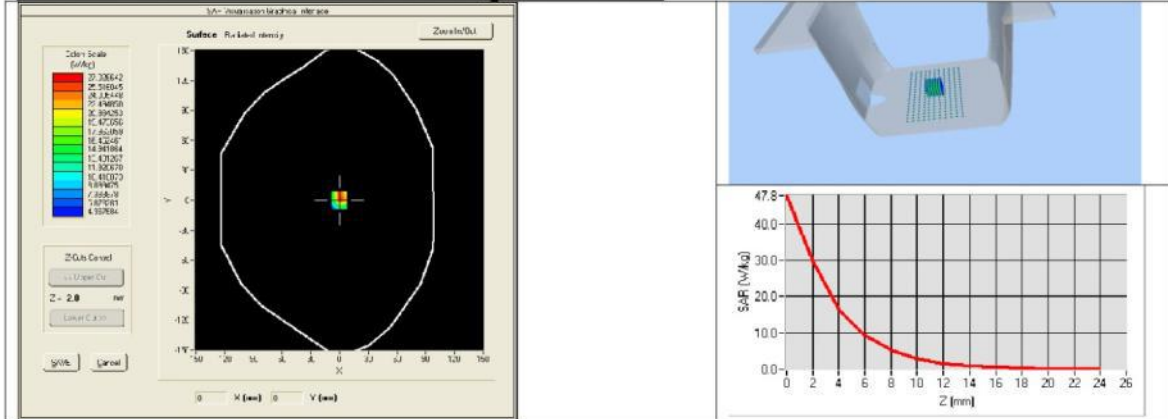

SAR MEASUREMENT PLOTS @ 5600 MHz

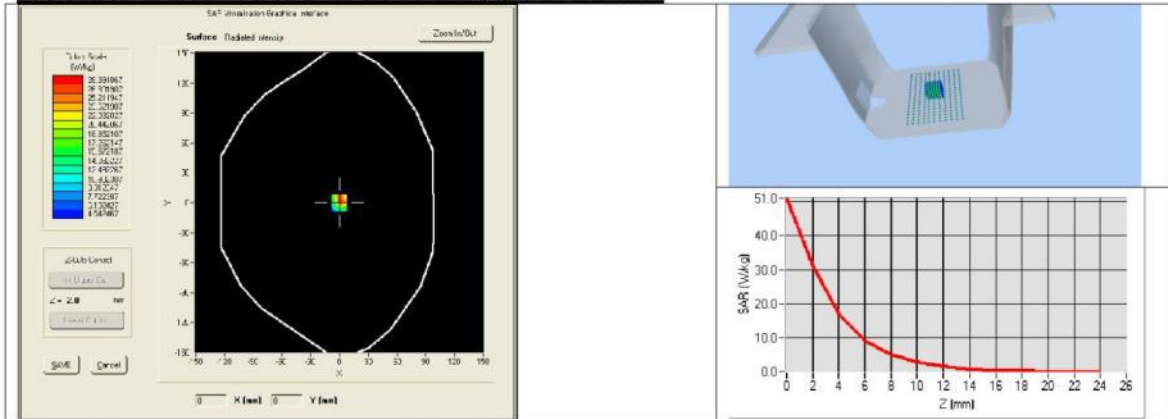

SAR MEASUREMENT PLOTS @ 5800 MHz

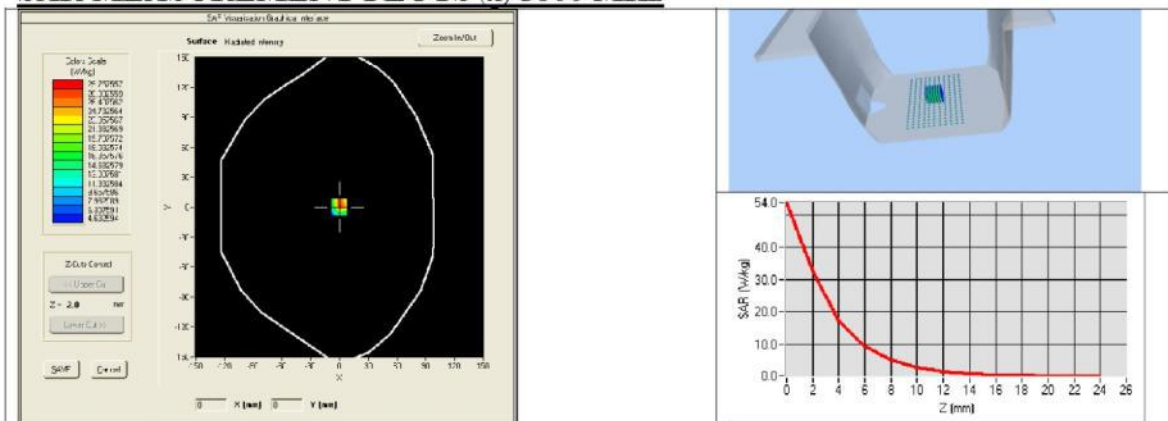

This document shall not be reproduced, except in full or in part, without the written approval of MVG. The information contained herein is to be used only for the purpose for which it is submitted and is not to be released in whole or part without written approval of MVG.



## SAR REFERENCE WAVEGUIDE CALIBRATION REPORT

Ref: ACR.273.5.18.SATU.A

## 7.3 BODY LIQUID MEASUREMENT

Frequency MHz	Relative permittivity ( $\epsilon_r'$ )		Conductivity ( $\sigma$ ) S/m	
	required	measured	required	measured
5200	49.0 $\pm$ 10 %	PASS	5.30 $\pm$ 10 %	PASS
5300	48.9 $\pm$ 10 %		5.42 $\pm$ 10 %	
5400	48.7 $\pm$ 10 %	PASS	5.53 $\pm$ 10 %	PASS
5500	48.6 $\pm$ 10 %		5.65 $\pm$ 10 %	
5600	48.5 $\pm$ 10 %	PASS	5.77 $\pm$ 10 %	PASS
5800	48.2 $\pm$ 10 %	PASS	6.00 $\pm$ 10 %	PASS

## 7.4 SAR MEASUREMENT RESULT WITH BODY LIQUID

Software	OPENSAR V4
Phantom	SN 20/09 SAM71
Probe	SN 18/11 EPG122
Liquid	Body Liquid Values 5200 MHz: $\epsilon_r'$ :48.64 sigma : 5.51 Body Liquid Values 5400 MHz: $\epsilon_r'$ :46.52 sigma : 5.77 Body Liquid Values 5600 MHz: $\epsilon_r'$ :46.79 sigma : 5.77 Body Liquid Values 5800 MHz: $\epsilon_r'$ :47.04 sigma : 6.10
Distance between dipole waveguide and liquid	0 mm
Area scan resolution	dx=8mm/dy=8mm
Zoon Scan Resolution	dx=4mm/dy=4m/dz=2mm
Frequency	5200 MHz 5400 MHz 5600 MHz 5800 MHz
Input power	20 dBm
Liquid Temperature	21 °C
Lab Temperature	21 °C
Lab Humidity	45 %

Frequency (MHz)	1 g SAR (W/kg)	10 g SAR (W/kg)
	measured	measured
5200	159.09 (15.91)	56.13 (5.61)
5400	164.56 (16.46)	57.31 (5.73)
5600	172.25 (17.23)	59.72 (5.97)
5800	177.77 (17.78)	61.06 (6.11)

Page: 10/13

*This document shall not be reproduced, except in full or in part, without the written approval of MVG.  
The information contained herein is to be used only for the purpose for which it is submitted and is not to be released in whole or part without written approval of MVG.*



SAR REFERENCE WAVEGUIDE CALIBRATION REPORT

Ref: ACR.273.5.18.SATU.A

BODY SAR MEASUREMENT PLOTS @ 5200 MHz

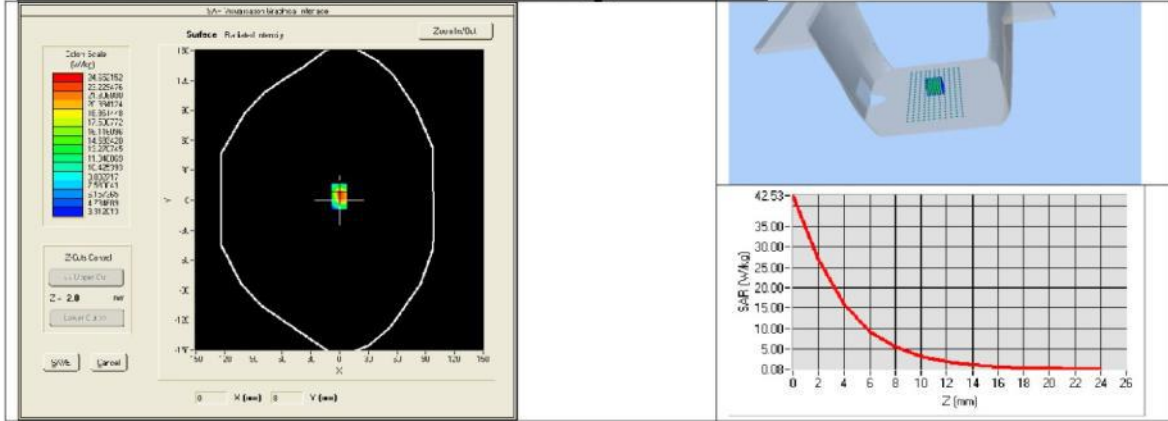

BODY SAR MEASUREMENT PLOTS @ 5400 MHz

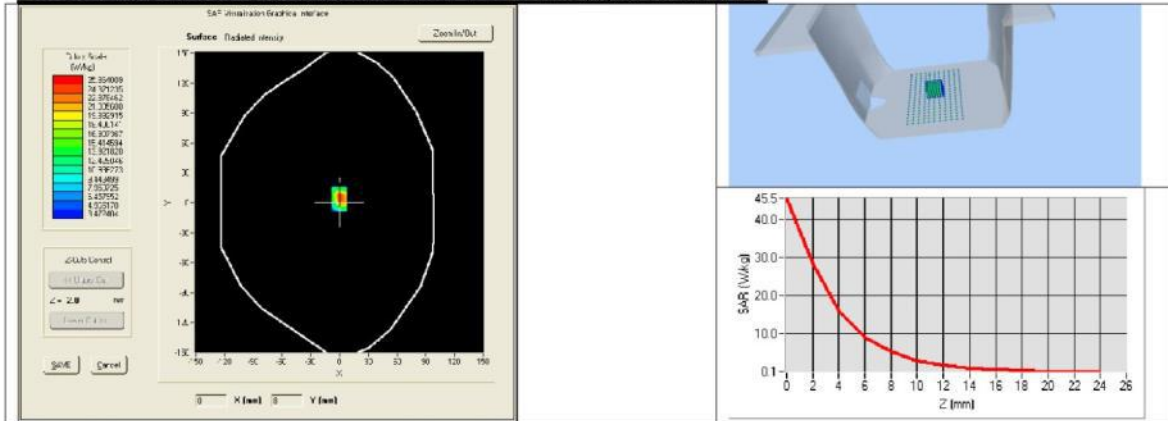

BODY SAR MEASUREMENT PLOTS @ 5600 MHz

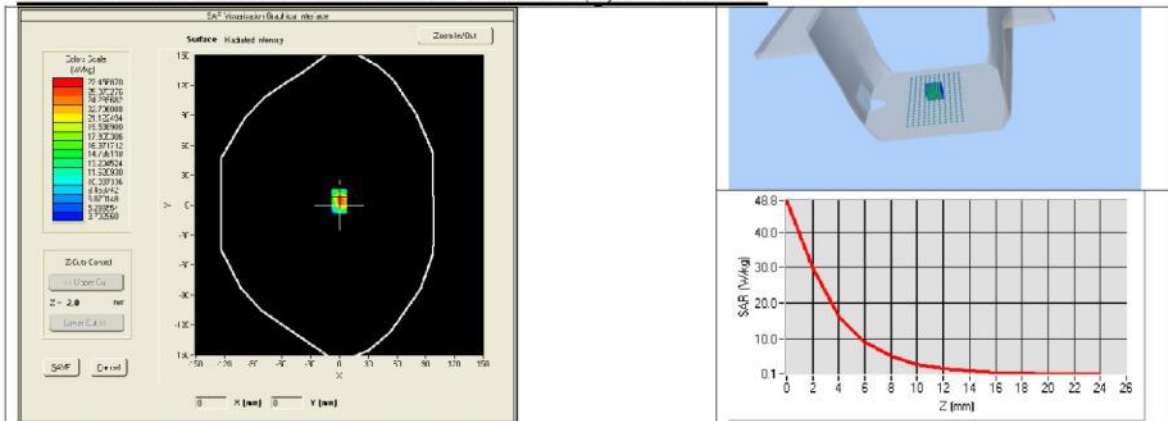

This document shall not be reproduced, except in full or in part, without the written approval of MVG. The information contained herein is to be used only for the purpose for which it is submitted and is not to be released in whole or part without written approval of MVG.



SAR REFERENCE WAVEGUIDE CALIBRATION REPORT

Ref: ACR.273.5.18.SATU.A

BODY SAR MEASUREMENT PLOTS @ 5800 MHz

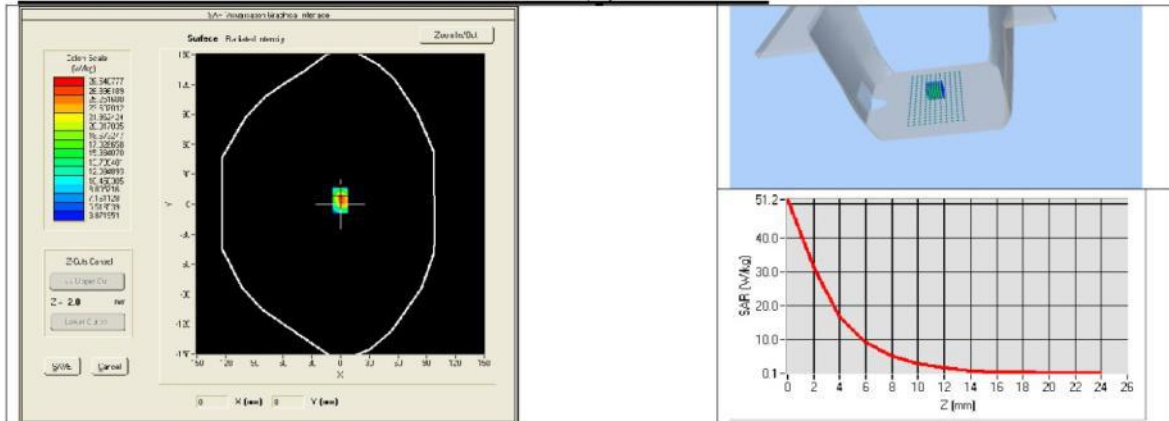

This document shall not be reproduced, except in full or in part, without the written approval of MVG. The information contained herein is to be used only for the purpose for which it is submitted and is not to be released in whole or part without written approval of MVG.



## SAR REFERENCE WAVEGUIDE CALIBRATION REPORT

Ref: ACR.273.5.18.SATU.A

## 8 LIST OF EQUIPMENT

Equipment Summary Sheet				
Equipment Description	Manufacturer / Model	Identification No.	Current Calibration Date	Next Calibration Date
Flat Phantom	MVG	SN-20/09-SAM71	Validated. No cal required.	Validated. No cal required.
COMOSAR Test Bench	Version 3	NA	Validated. No cal required.	Validated. No cal required.
Network Analyzer	Rhode & Schwarz ZVA	SN100132	02/2016	02/2019
Calipers	Carrera	CALIPER-01	01/2017	01/2020
Reference Probe	MVG	EPG122 SN 18/11	10/2017	10/2018
Multimeter	Keithley 2000	1188656	01/2017	01/2020
Signal Generator	Agilent E4438C	MY49070581	01/2017	01/2020
Amplifier	Aethercomm	SN 046	Characterized prior to test. No cal required.	Characterized prior to test. No cal required.
Power Meter	HP E4418A	US38261498	01/2017	01/2020
Power Sensor	HP ECP-E26A	US37181460	01/2017	01/2020
Directional Coupler	Narda 4216-20	01386	Characterized prior to test. No cal required.	Characterized prior to test. No cal required.
Temperature and Humidity Sensor	Control Company	150798832	11/2017	11/2020

Page: 13/13

*This document shall not be reproduced, except in full or in part, without the written approval of MVG.  
The information contained herein is to be used only for the purpose for which it is submitted and is not to be released in whole or part without written approval of MVG.*



## 6. SAR System PHOTOGRAPHS



Liquid depth  $\cong$  15cm



## 7. SETUP PHOTOGRAPHS

Head Setup Photo (Left Cheek)

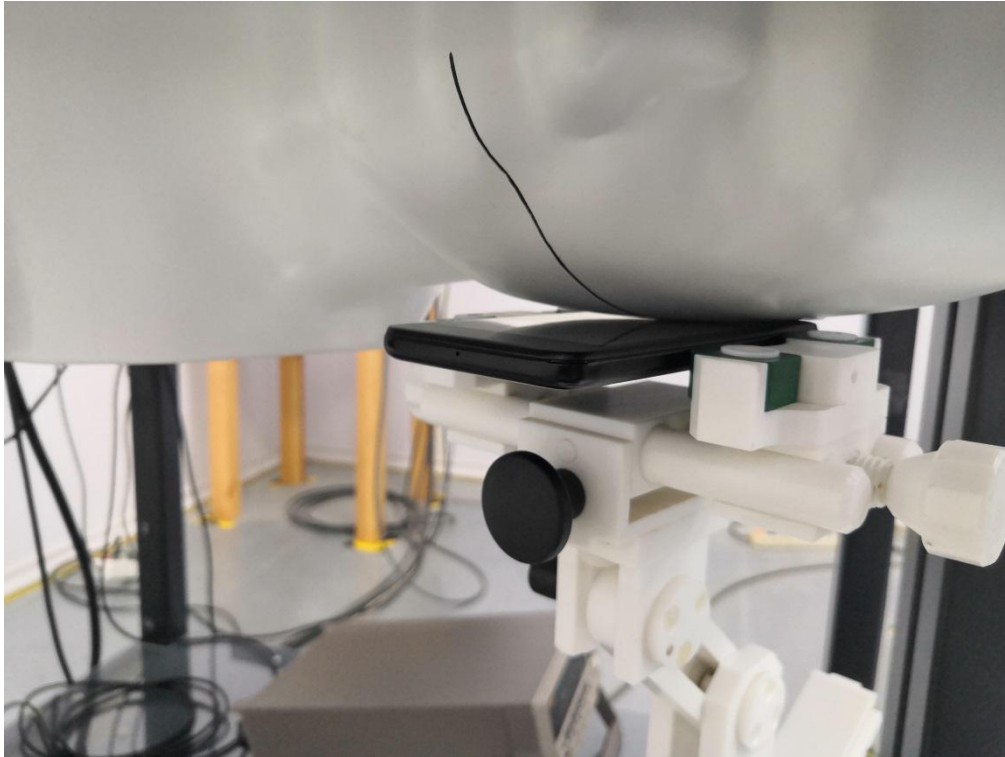

Head Setup Photo (Left Tilt)

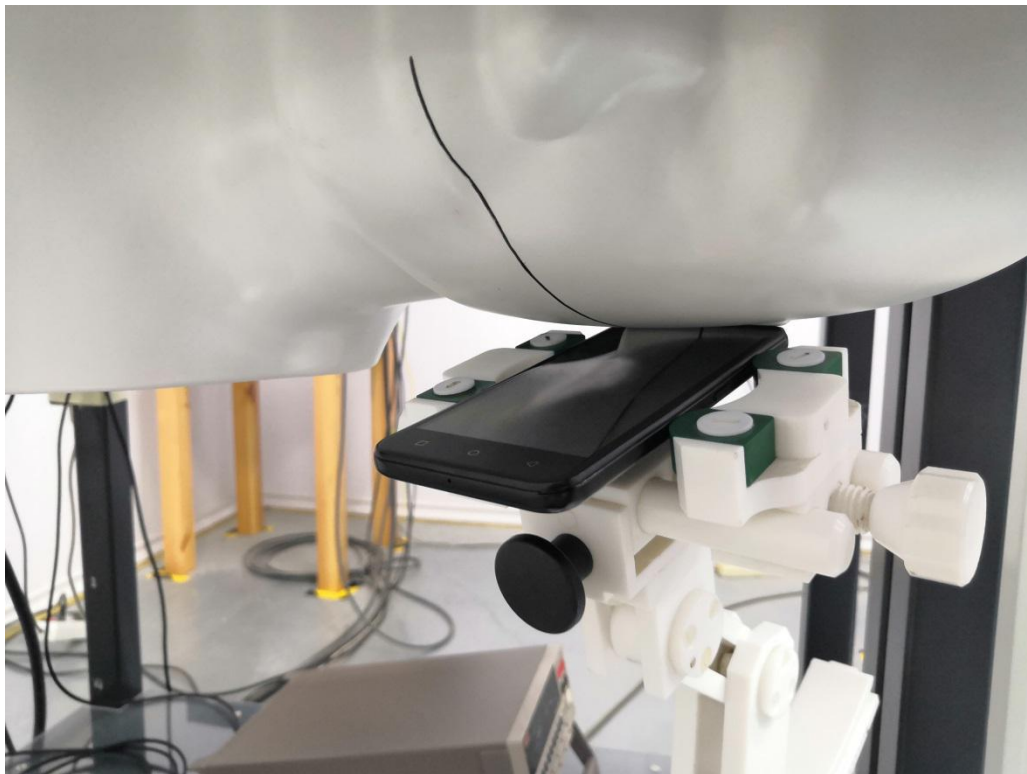

**Head Setup Photo (Right Cheek)**

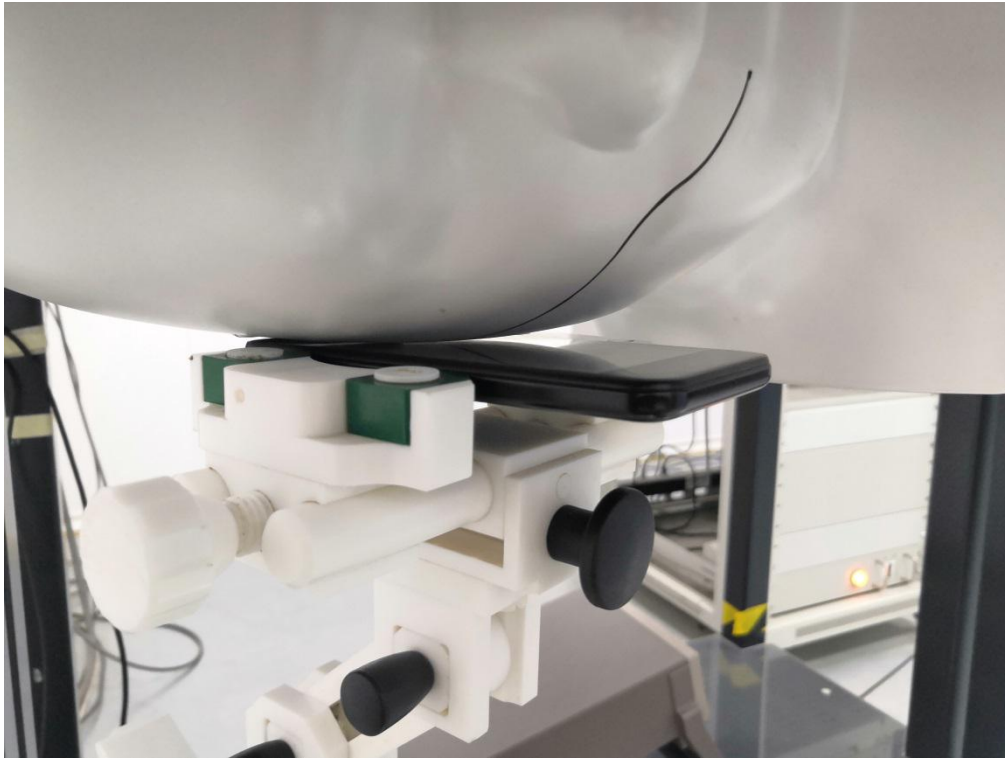

**Head Setup Photo (Right Tilt)**

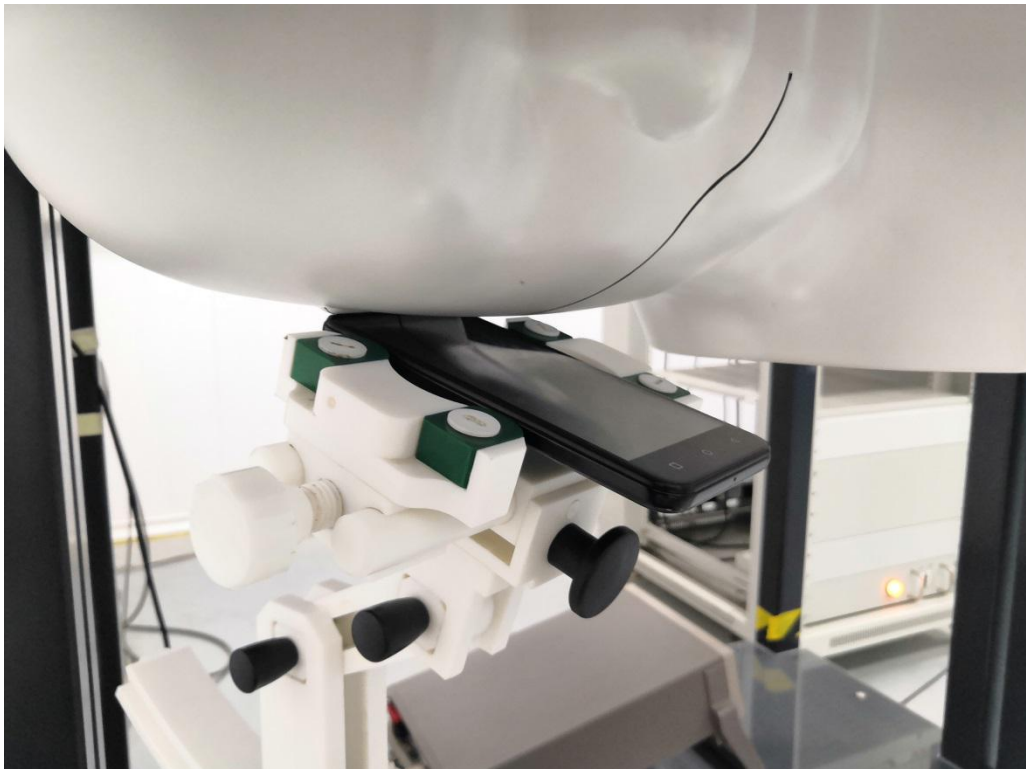

**10mm body-worn Back Side Setup Photo (hotspot)**

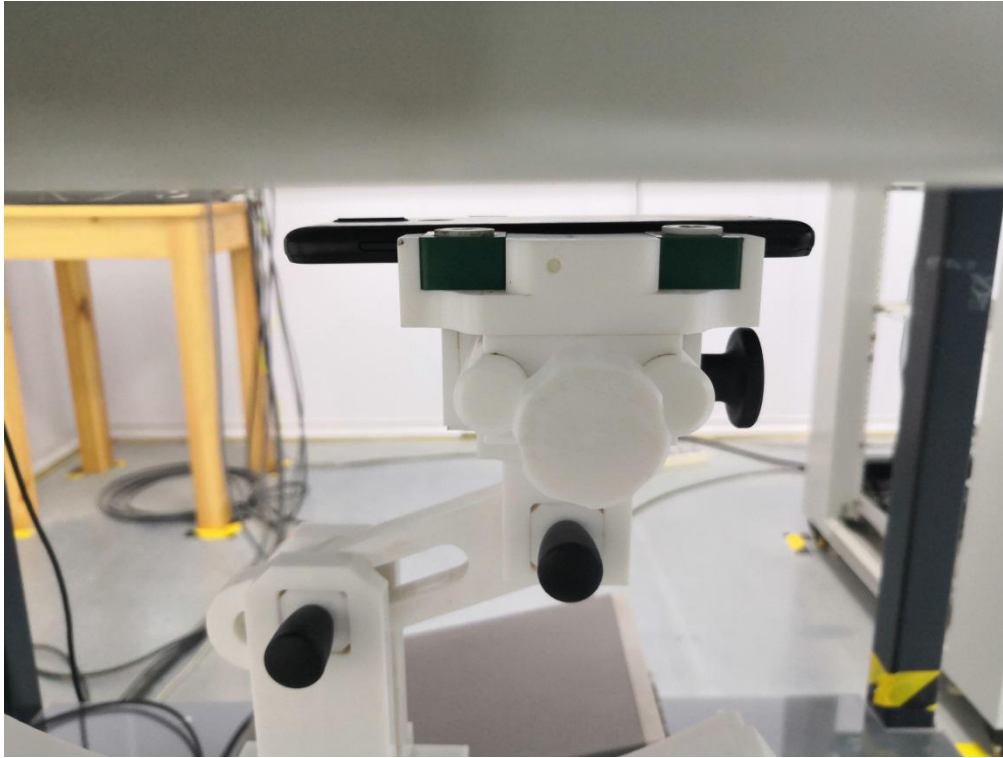

**10mm body-worn Front Side Setup Photo (hotspot)**

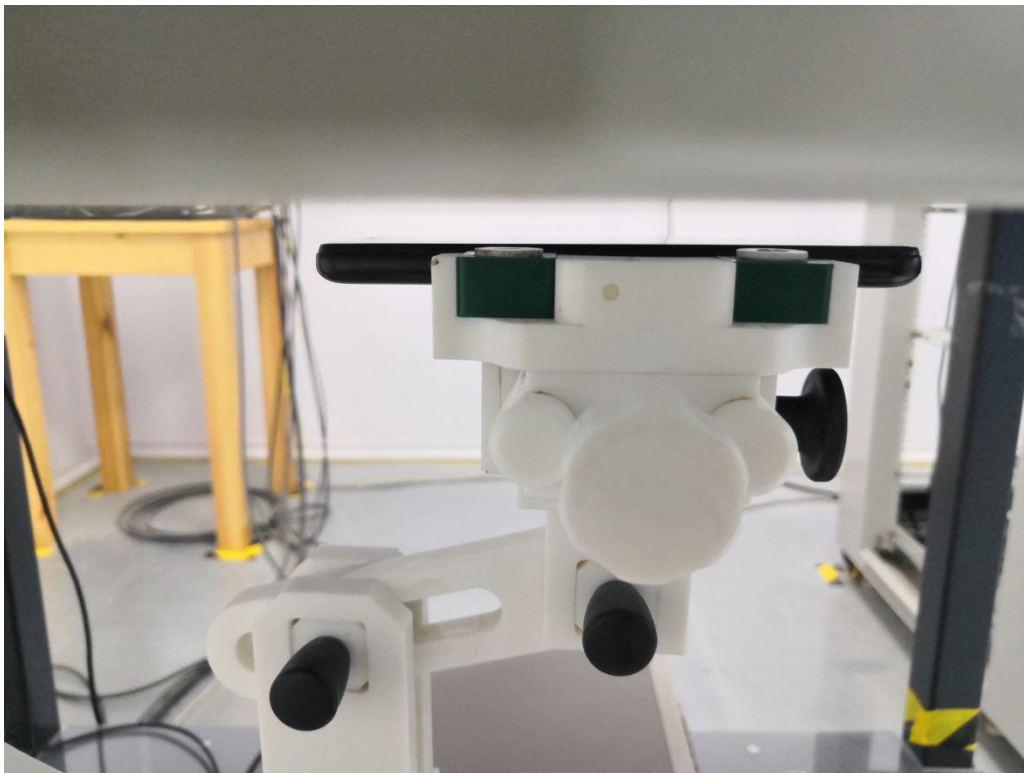

**10mm body-worn Left Side Setup Photo (hotspot)**



**10mm body-worn Right Side Setup Photo (hotspot)**



**10mm body-worn Top Side Setup Photo (hotspot)**



**10mm body-worn Bottom Side Setup Photo (hotspot)**



### 6. EUT PHOTOGRAPHS

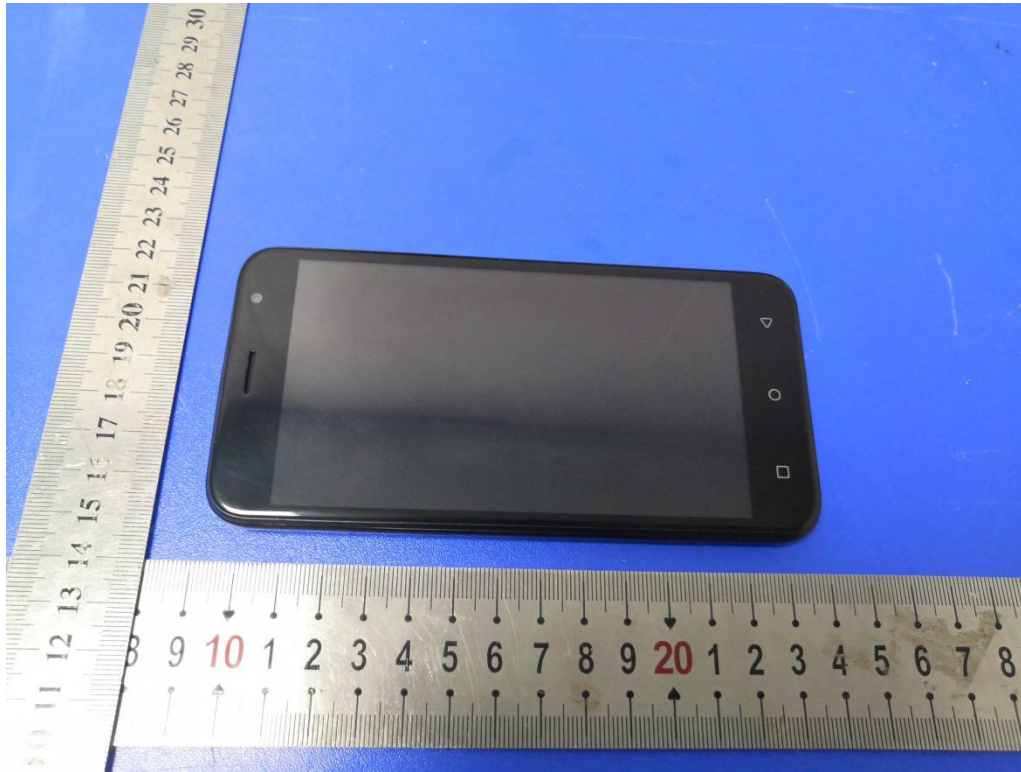

Fig.1

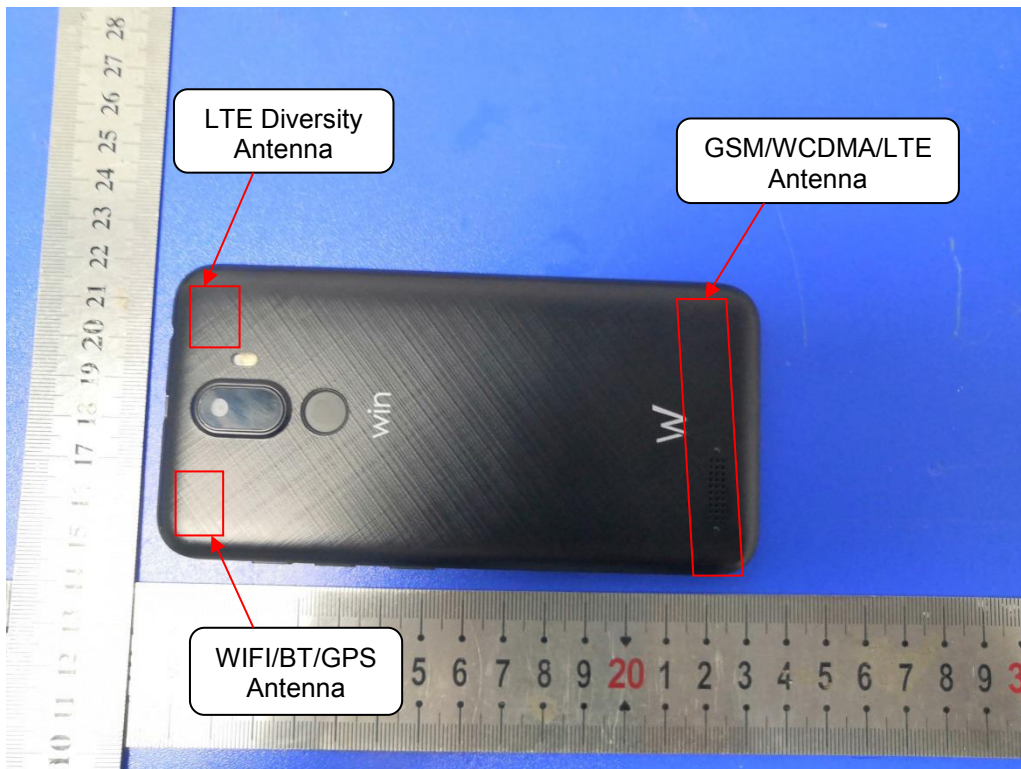

Fig. 2

.....The End of Test Report.....