



FCC SAR Test Report

Product : bikefinder
Trade mark :  
Model/Type reference : BFG1T
Serial Number : N/A
Report Number : EED32O81469403
FCC ID : 2ATRU-BFG1S
Date of Issue: : Nov. 17, 2022
Test Standards : Refer to Section 1.5
Test result : PASS

Prepared for:

BikeFinder AS

Veritasveien 25, 4007 Stavanger, Postbox 4004 4092 Stavanger, Norway

Prepared by:

Centre Testing International Group Co., Ltd.

Hongwei Industrial Zone, Bao'an 70 District,

Shenzhen, Guangdong, China

TEL: +86-755-3368 3668

FAX: +86-755-3368 3385

Compiled by:

mark.chen.

Reviewed by:

Tom Chen

Mark Chen

Tom Chen

Approved by:

Aaron Ma

Date:

Nov. 17, 2022

Aaron Ma

Check No.: 7002190922



Table of contents

1 General information	5
1.1 Notes	5
1.2 Application details	5
1.3 Statement of Compliance	6
1.4 EUT Information	7
1.5 Test standard/s	8
1.6 RF exposure limits	9
1.7 SAR Definition	9
1.8 Testing laboratory	10
1.9 Test Environment	10
1.10 Applicant and Manufacturer	10
2 SAR Measurement System Description and Setup	11
2.1 The Measurement System Description	11
2.2 Probe description	12
2.3 Data Acquisition Electronics description	13
2.4 SAM Twin Phantom description	14
2.5 ELI4 Phantom description	15
2.6 Device Holder description	16
3 SAR Test Equipment List	17
4 SAR Measurement Procedures	18
4.1 Spatial Peak SAR Evaluation	18
4.2 Data Storage and Evaluation	19
4.3 Data Storage and Evaluation	23
5 SAR Verification Procedure	25
5.1 Tissue Verification	25
5.2 System check procedure	27
5.3 System check results	28
6 SAR Measurement variability and uncertainty	29
6.1 SAR measurement variability	29
6.2 SAR measurement uncertainty	29
7 SAR Test Configuration	30
7.1 GSM Test Configurations	30
8 SAR Test Results	31
8.1 Conducted Power Measurements	31

8.1.1 Conducted Power of GSM850	31
8.1.2 Conducted Power of GSM1900	32
8.1.3 Conducted Power of BT	33
8.2 SAR test results	34
8.2.1 Results overview of GSM850	35
8.2.2 Results overview of GSM1900	36
8.3 Multiple Transmitter Information	37
8.4 Stand-alone SAR	38
8.5 Simultaneous Transmission analysis	39
8.6 SAR Summation Scenario	40
8.7 Simultaneous Transmission Conclusion	40
Annex A: Appendix A: SAR System performance Check Plots	41
Annex B: Appendix B: SAR Measurement results Plots	41
Annex C: Appendix C: Calibration reports	41
Annex D: Appendix D: Photo documentation	41

Version No.	Date	Description
00	Nov. 17, 2022	Original

1 General information

1.1 Notes

The test results of this test report relate exclusively to the test item specified in this test report.

Centre Testing International Group Co., Ltd. does not assume responsibility for any conclusions and generalisations drawn from the test results with regard to other specimens or samples of the type of the equipment represented by the test item. The test report is not to be reproduced or published in full without the prior written permission.

1.2 Application details

Date of receipt of test item: 2022-10-23

Start of test: 2022-10-24

End of test: 2022-11-16

1.3 Statement of Compliance

The maximum results of Specific Absorption Rate (SAR) found during testing for Bikefinder AS Model Name:BFG1T are as below:

Frequency Band	MAX Reported SAR (W/kg)		
	1-g SAR Head	1-g SAR Limbs (0mm)	1-g SAR Hotspot (10mm)
GSM850	N/A	2.589	N/A
GSM1900	N/A	0.997	N/A

The highest simultaneous SAR is 2.612W/kg per KDB 690783 D01

Note:

For body operation, this device has been tested and meets FCC/IC RF exposure guidelines when used with any accessory that contains no metal and that positions a minimum of 15mm from the body. Use of other accessories may not ensure compliance with FCC/IC RF exposure guidelines.

The device is in compliance with Specific Absorption Rate (SAR) for general population/uncontrolled exposure limits according to the FCC rule §2.1093, the ANSI/IEEE C95.1:1992, the NCRP Report Number 86 for uncontrolled environment, according to the Industry Canada Radio Standards Specification RSS-102 for General Population/Uncontrolled exposure, and had been tested in accordance with the measurement methods and procedures specified in IEEE Std 1528-2013

1.4 EUT Information

Device Information:			
Product Name:	bikefinder		
Model:	BFG1T		
FCC ID:	2ATRU-BFG1S		
Device Type:	Portable device		
Exposure Category:	uncontrolled environment / general population		
Firmware version:	2.0/2.0.45		
Hardware version:	1.3.1		
Antenna Type :	Monopole LDS Antenna		
Antenna Gain:	2.4G -2.12dBi		
Device Operating Configurations:			
Supporting Modes :	GPRS 850/1900; BT;		
Modulation:	GPRS(GMSK); BT(GFSK)		
Operating Frequency Range(s)	Band	TX(MHz)	RX(MHz)
	GSM850	824~849	869~894
	GSM1900	1850~1910	1930~1990
	BT	2402~2480	
GPRS class level:	GPRS class 12		
Test Channels (low-mid-high):	128-190-251 (GPRS850)		
	512-661-810 (GPRS1900)		
	0-19-39 (BT)		
Power Source:	Polymer Lithium Ion Batteries 3.8V		

Remark: Company Name and Address shown on Report, the sample(s) and sample Information was/ were provided by the applicant who should be responsible for the authenticity which CTI hasn't verified.

1.5 Test standard/s

ANSI Std C95.1-1992	Safety Levels with Respect to Human Exposure to Radio Frequency Electromagnetic Fields, 3 kHz to 300 GHz.
IEEE Std 1528-2013	Recommended Practice for Determining the Peak Spatial-Average Specific Absorption Rate (SAR) in the Human Head from Wireless Communications Devices: Measurement Techniques
RSS-102	Radio Frequency Exposure Compliance of Radiocommunication Apparatus (All Frequency Bands (Issue 5 of February 2021))
KDB 248227 D01	SAR guidance for IEEE 802.11(Wi-Fi) transmitters v02r02
KDB 447498 D04	Interim General RF Exposure Guidance v01
KDB 648474 D04	Handsets SAR v01r03
KDB 690783 D01	SAR Listings on Grants v01r03
KDB 865664 D01	SAR Measurement 100 MHz to 6 GHz v01r04
KDB 865664 D02	RF Exposure Reporting v01r02
KDB 941225 D01	3G SAR Procedures v03r01
KDB 941225 D05	SAR for LTE Devices v02r05
KDB 941225 D06	Hotspot SAR v02r01

1.6 RF exposure limits

Human Exposure	Uncontrolled Environment General Population	Controlled Environment Occupational
Spatial Peak SAR* (Brain/Body/Arms/Legs)	1.60 mW/g	8.00 mW/g
Spatial Average SAR** (Whole Body)	0.08 mW/g	0.40 mW/g
Spatial Peak SAR*** (Hands/Feet/Ankle/Wrist)	4.00 mW/g	20.00 mW/g

The limit applied in this test report is shown in bold letters

Notes:

* The Spatial Peak value of the SAR averaged over any 1 gram of tissue (defined as a tissue volume in the shape of a cube) and over the appropriate averaging time.

** The Spatial Average value of the SAR averaged over the whole body.

*** The Spatial Peak value of the SAR averaged over any 10 grams of tissue (defined as a tissue volume in the shape of a cube) and over the appropriate averaging time.

Uncontrolled Environments are defined as locations where there is the exposure of individuals who have no knowledge or control of their exposure.

Controlled Environments are defined as locations where there is exposure that may be incurred by persons who are aware of the potential for exposure, (i.e. as a result of employment or occupation).

1.7 SAR Definition

Specific Absorption Rate is defined as the time derivative (rate) of the incremental energy (dW) absorbed by(dissipated in) an incremental mass (dm) contained in a volume element (dV) of a given density (ρ).

$$SAR = \frac{d}{dt} \left(\frac{dW}{dm} \right) = \frac{d}{dt} \left(\frac{dW}{\rho dV} \right)$$

SAR is expressed in units of watts per kilogram (W/kg). SAR can be related to the electric field at a point by

$$SAR = \frac{\sigma |E|^2}{\rho}$$

where:

σ = conductivity of the tissue (S/m)
 ρ = mass density of the tissue (kg/m³)
 E = rms electric field strength (V/m)

1.8 Testing laboratory

Test Site	Centre Testing International Group Co., Ltd.
Test Location	Hongwei Industrial Zone, Bao'an 70 District, Shenzhen, Guangdong, China
Telephone	+86 (0) 755 3368 3668
Fax	+86 (0) 755 3368 3385

1.9 Test Environment

	Required	Actual
Ambient temperature:	18 – 25 °C	21.5 ± 2.0 °C
Tissue Simulating liquid:	18 – 25 °C	21.5 ± 2.0 °C
Relative humidity content:	30 – 70 %	30 – 70 %

1.10 Applicant and Manufacturer

Applicant/Client :	BikeFinder AS
Applicant Address:	Veritasveien 25, 4007 Stavanger, Postbox 4004 4092 Stavanger, Norway
Manufacturer Name:	BikeFinder AS
Manufacturer Address:	Veritasveien 25, 4007 Stavanger, Postbox 4004 4092 Stavanger, Norway
Factory:	High Quality PCB Co., Limited
Address of Factory:	1701 RM, Floor 17, Yunhua Shidai, Shajing Bao'an, Shenzhen

2 SAR Measurement System Description and Setup

2.1 The Measurement System Description

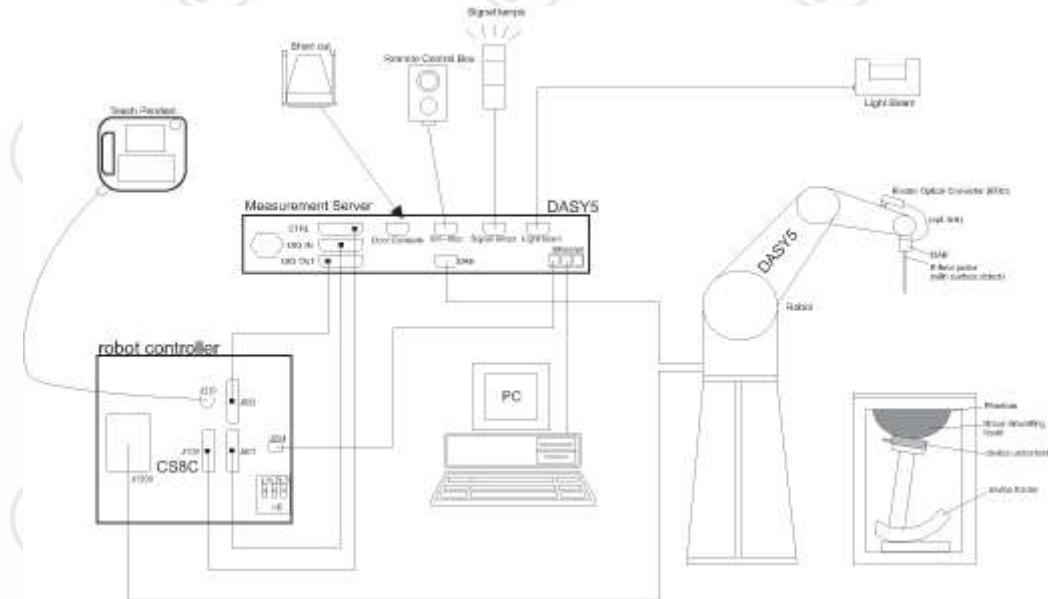

The DASYS system for performing compliance tests consists of the following items:

- A standard high precision 6-axis robot (Stäubli TX/RX family) with controller, teach pendant and software. An arm extension for accommodating the data acquisition electronics (DAE).
- An isotropic field probe optimized and calibrated for the targeted measurement.
- A data acquisition electronics (DAE) which performs the signal amplification, signal multiplexing, AD-conversion, offset measurements, mechanical surface detection, collision detection, etc. The unit is battery powered with standard or rechargeable batteries. The signal is optically transmitted to the EOC.
- The Electro-optical converter (EOC) performs the conversion from optical to electrical signals for the digital communication to the DAE. To use optical surface detection, a special version of the EOC is required. The EOC signal is transmitted to the measurement server.
- The function of the measurement server is to perform the time critical tasks such as signal filtering, control of the robot operation and fast movement interrupts.
- The Light Beam used is for probe alignment. This improves the (absolute) accuracy of the probe positioning.
- A computer running Win7 professional operating system and the DASY5 software.
- Remote control and teach pendant as well as additional circuitry for robot safety such as warning lamps, etc.
- The phantom, the device holder and other accessories according to the targeted measurement.

2.2 Probe description

Dosimetric Probes: These probes are specially designed and calibrated for use in liquids with high permittivities. They should not be used in air, since the spherical isotropy in air is poor(± 2 dB). The dosimetric probes have special calibrations in various liquids at different frequencies.

Construction	Symmetrical design with triangular core Interleaved sensors Built-in shielding against static charges PEEK enclosure material (resistant to organic solvents, e.g., DGBE)
Calibration	ISO/IEC 17025 calibration service available.
Frequency	10 MHz to 6 GHz; Linearity: ± 0.2 dB
Probe Overall Length	337mm
Probe Body Diameter	10mm
Tip Length	9mm
Tip Diameter	2.5mm
Dynamic range	5 μ W/g to 100 mW/g; Linearity: ± 0.2 dB



2.3 Data Acquisition Electronics description

The data acquisition electronics (DAE4) consist of a highly sensitive electrometer-grade preamplifier with auto-zeroing, a channel and gain-switching multiplexer, a fast 16 bit AD-converter and a command decoder with a control logic unit. Transmission to the measurement server is accomplished through an optical downlink for data and status information, as well as an optical uplink for commands and the clock.

The mechanical probe mounting device includes two different sensor systems for frontal and sideways probe contacts. They are used for mechanical surface detection and probe collision detection. The input impedance of the DAE4 box is 200M Ω ; the inputs are symmetrical and floating. Common mode rejection is above 80 dB.

Batteries: The DAE works with either two standard 9V batteries or two 9V (actually 8.4V or 9.6 V) rechargeable batteries. Because the electronics automatically power-down unused components during braking or between measurements, the battery lifetime depends on system usage. Typical lifetimes are >20 hours for batteries and >10 hours for accus. Remove the batteries if you do not plan to use the DAE for a long period of time.

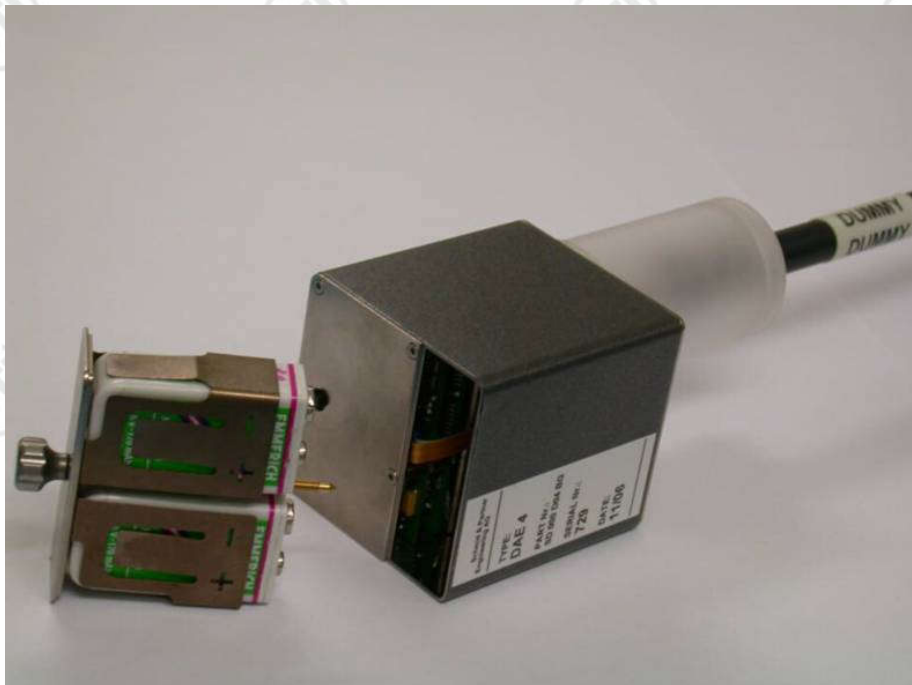

2.4 SAM Twin Phantom description

The SAM twin phantom is a fiberglass shell phantom with 2mm shell thickness (except the ear region, where shell thickness increases to 6 mm). The phantom has three measurement areas:

- ◆ Left hand
- ◆ Right hand
- ◆ Flat phantom

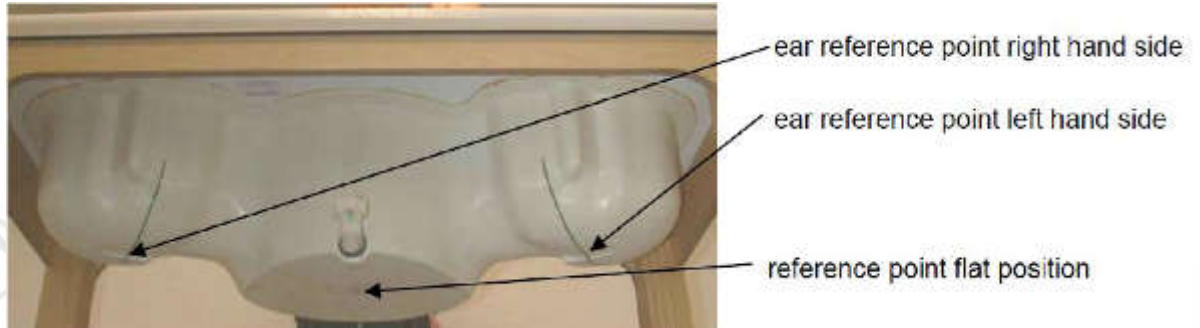

The phantom table for the DASY systems have the size of 100 x 50 x 85 cm (L x W x H). These tables are reinforced for mounting of the robot onto the table. For easy dislocation these tables have fork lift cut outs at the bottom.

The bottom plate contains three pairs of bolts for locking the device holder. The device holder positions are adjusted to the standard measurement positions in the three sections.

A white cover is provided to cover the phantom during off-periods to prevent water evaporation and changes in the liquid parameters.

Three reference marks are provided on the phantom counter. These reference marks are used to teach the absolute phantom position relative to the robot.



2.5 ELI4 Phantom description

The ELI4 phantom is intended for compliance testing of handheld and body mounted wireless devices in the frequency range of 30MHz to 6 GHz. ELI4 is fully compatible with the latest draft of the standard IEC 62209-2 and all known tissue simulating liquids.

ELI4 has been optimized regarding its performance and can be integrated into a SPEAG standard phantom table.

A cover prevents evaporation of the liquid. Reference markings on the phantom allow installation of the complete setup, including all predefined phantom positions and measurement grids, by teaching three points

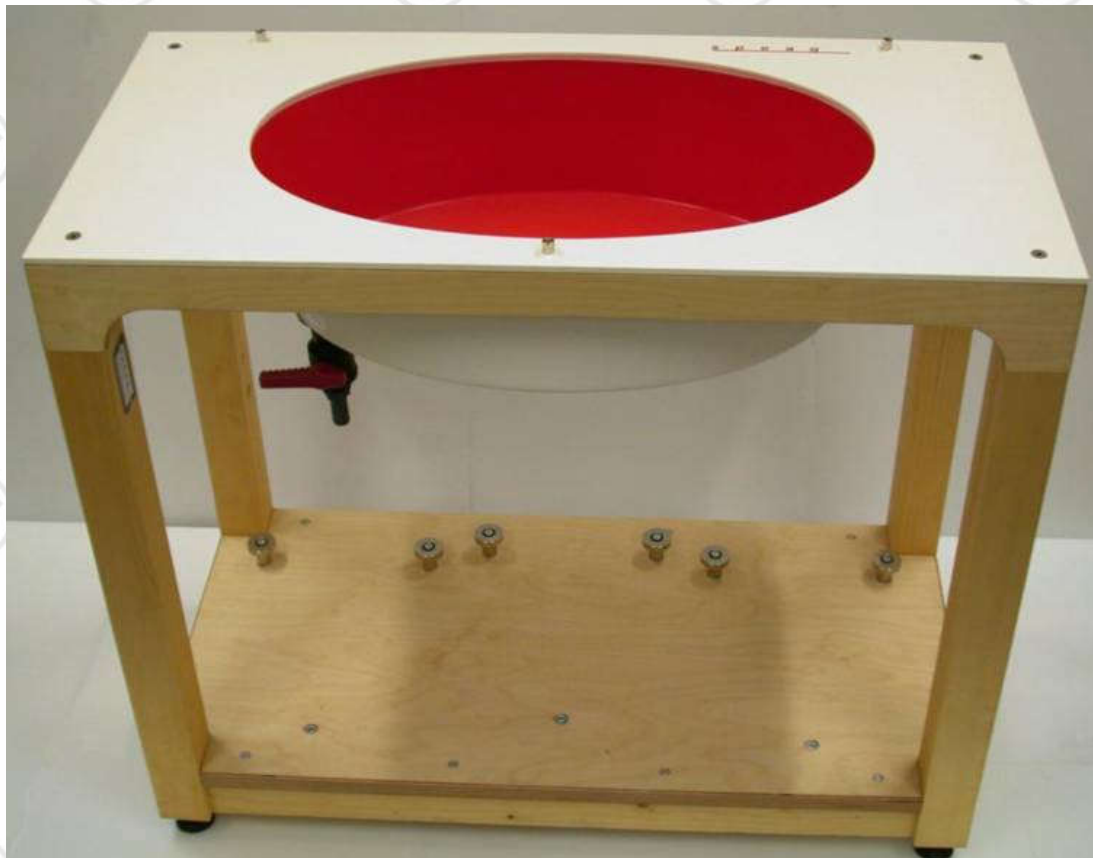

2.6 Device Holder description

The SAR in the phantom is approximately inversely proportional to the square of the distance between the source and the liquid surface. For a source at 5mm distance, a positioning uncertainty of $\pm 0.5\text{mm}$ would produce a SAR uncertainty of $\pm 20\%$. Accurate device positioning is therefore crucial for accurate and repeatable measurements. The positions in which the devices must be measured are defined by the standards.

The DASY device holder is designed to cope with the different positions given in the standard. It has two scales for device rotation (with respect to the body axis) and device inclination (with respect to the line between the ear reference points). The rotation centers for both scales is the ear reference point (ERP). Thus the device needs no repositioning when changing the angles.

The DASY device holder is constructed of low-loss POM material having the following dielectric parameters: relative permittivity $\epsilon = 3$ and loss tangent $\delta = 0.02$. The amount of dielectric material has been reduced in the closest vicinity of the device, since measurements have suggested that the influence of the clamp on the test results could thus be lowered.



3 SAR Test Equipment List

To simplify the identification of the test equipment and/or ancillaries which were used, the reporting of the relevant test cases only refer to the test item number as specified in the table below.

	Manufacturer	Device Type	Type(Model)	Serial number	Date of last calibration	Valid period
<input checked="" type="checkbox"/>	SPEAG	E-Field Probe	EX3DV4	7328	2022-02-27	One year
<input type="checkbox"/>	SPEAG	E-Field Probe	EX3DV4	7591	2021-08-12	One year
<input checked="" type="checkbox"/>	SPEAG	835 MHz Dipole	D835V2	4d193	2021-01-12	Three years
<input type="checkbox"/>	SPEAG	1750 MHz Dipole	D1750V2	1134	2021-01-12	Three years
<input checked="" type="checkbox"/>	SPEAG	1900 MHz Dipole	D1900V2	5d198	2021-01-12	Three years
<input type="checkbox"/>	SPEAG	2000 MHz Dipole	D2000V2	1078	2021-01-12	Three years
<input type="checkbox"/>	SPEAG	2300 MHz Dipole	D2300V2	1082	2020-01-06	Three years
<input type="checkbox"/>	SPEAG	2450 MHz Dipole	D2450V2	959	2021-01-12	Three years
<input type="checkbox"/>	SPEAG	2600 MHz Dipole	D2600V2	1101	2021-01-12	Three years
<input type="checkbox"/>	SPEAG	5 GHz Dipole	D5GHzV2	1208	2021-01-12	Three years
<input checked="" type="checkbox"/>	SPEAG	DAKS Probe	DAKS-3.5	1052	2021-01-27	Three years
<input checked="" type="checkbox"/>	SPEAG	Planar R140 Vector Reflectometer	DAKS-VNA R140	0200514	2021-01-27	Three years
<input checked="" type="checkbox"/>	SPEAG	Data acquisition electronics	DAE4	1458	2022-01-04	One year
<input checked="" type="checkbox"/>	SPEAG	Software	DASY 5	NA	NCR	NCR
<input type="checkbox"/>	SPEAG	Twin Phantom	SAM V5.0	1875	NCR	NCR
<input checked="" type="checkbox"/>	SPEAG	Flat Phantom	ELI V6.0	2024	NCR	NCR
<input type="checkbox"/>	R & S	Universal Radio Communication Tester	CMU200	101553	2021-12-24	One year
<input type="checkbox"/>	R & S	Universal Radio Communication Tester	CMW500	102898	2021-12-24	One year
<input checked="" type="checkbox"/>	Agilent	Signal Generator	N5181A	MY50142334	2021-12-24	One year
<input checked="" type="checkbox"/>	BONN	Power Amplifier and directional coupler	SU319W	BL-SZ1550140	2021-12-24	One year
<input checked="" type="checkbox"/>	KEITHLEY	RF Power Meter	3500	1128079	2022-07-01	One year
<input checked="" type="checkbox"/>	KEITHLEY	RF Power Meter	3500	1128081	2022-07-01	One year
<input checked="" type="checkbox"/>	JINGCHUAN G	Temperature/ Humidity Indicator	GSP-8	EMK197F0009 5	2022-07-01	One year

Note:

- There is no physical damage on the dipole;
- System check with specific dipole is within 10% of calibrated value;
- The most recent return-loss result, measured at least annually, deviates by no more than 20% from the previous measurement.
- The most recent measurement of the real or imaginary parts of the impedance, measured at least annually is within 5Ω from the previous measurement.

4 SAR Measurement Procedures

4.1 Spatial Peak SAR Evaluation

The DASY5 software includes all numerical procedures necessary to evaluate the spatial peak SAR values. The base for the evaluation is a "cube" measurement in a volume of 30mm³ (7x7x7 points). The measured volume must include the 1 g and 10 g cubes with the highest averaged SAR values. For that purpose, the center of the measured volume is aligned to the interpolated peak SAR value of a previously performed area scan. If the 10g cube or both cubes are not entirely inside the measured volumes, the system issues a warning regarding the evaluated spatial peak values within the Postprocessing engine (SEMCAD X). This means that if the measured volume is shifted, higher values might be possible. To get the correct values you can use a finer measurement grid for the area scan. In complicated field distributions, a large grid spacing for the area scan might miss some details and give an incorrectly interpolated peak location. The entire evaluation of the spatial peak values is performed within the Postprocessing engine (SEMCAD X). The system always gives the maximum values for the 1 g and 10 g cubes.

The algorithm to find the cube with highest averaged SAR is divided into the following stages:

1. extraction of the measured data (grid and values) from the Zoom Scan
2. calculation of the SAR value at every measurement point based on all stored data (A/D values and measurement parameters)
3. generation of a high-resolution mesh within the measured volume
4. interpolation of all measured values from the measurement grid to the high-resolution grid
5. extrapolation of the entire 3-D field distribution to the phantom surface over the distance from sensor to surface
6. calculation of the averaged SAR within masses of 1 g and 10 g

4.2 Data Storage and Evaluation

Data Storage

The DASY5 software stores the measured voltage acquired by the Data Acquisition Electronics (DAE) as raw data together with all the necessary software parameters for the data evaluation (probe calibration data, liquid parameters and communication system parameters) in measurement files with the extension .da5x. The postprocessing software evaluates the data every time the data is visualized or exported. This allows the verification and modification of the setup after completion of the measurement. For example, if a measurement has been performed with an incorrect crest factor, the parameter can be corrected afterwards and the data can be reevaluated.

To avoid unintentional parameter changes or data manipulations, the parameters in measured files are locked. In the administrator access mode of the software, the parameters can be unlocked. After changing the parameters, the measured scans can be reevaluated in the postprocessing engine.

The measured data can be visualized or exported in different units or formats, depending on the selected probe type (e.g., E-field, H-field, SAR). Some of these units are not available in certain situations or give meaningless results, e.g., a SAR-output in a lossless media will always be zero. Raw data can also be exported to perform the evaluation with other software packages.

Data Evaluation

The fields and SAR are calculated from the measured voltage (probe voltage acquired by the DAE) and the following parameters:

Probe parameters:	- Sensitivity	norm _i ,
a _{i0} , a _{i1} , a _{i2}		
	- Conversion Factor	convF _i
	- Diode Compression Point	dcp _i
	- Probe Modulation Response Factors	a _i , b _i , c _i , d
Device parameters:	- Frequency	f
	- Crest factor	cf
Media parameters:	- Conductivity	σ
	- Relative Permittivity	ρ

This parameters are stored in the DASY5 V52 measurement file.

These parameters must be correctly set in the DASYS V52 software setup. They are available as configuration file and can be imported into the measurement file. The values displayed in the multimeter window are assessed using the parameters of the actual system setup. In the scan visualization and export modes, the parameters stored in the measurement file are used.

The measured voltage is not proportional to the exciting. It must be first linearized.

Approximated Probe Response Linearization using Crest Factor.

This linearization method is enabled when a custom defined communication system is measured. The compensation applied is a function of the measured voltage, the diode compression point and the crest factor of the measured signal.

$$V_i = U_i + U_i^2 \cdot \frac{cf}{dcp_i}$$

with V_i = linearized voltage of channel i (uV) (i = x,y,z)
 U_i = measured voltage of channel i (uV) (i = x,y,z)
 cf = crest factor of exciting field (DASY parameter)
 dcp_i = diode compression point of channel i (uV) (Probe parameter, i = x,y,z)

Field and SAR Calculation

The primary field data for each channel are calculated using the linearized voltage:

$$E - \text{fieldprobes : } E_i = \sqrt{\frac{V_i}{\text{Norm}_i \cdot \text{ConvF}}}$$

$$H - \text{fieldprobes : } H_i = \sqrt{V_i} \cdot \frac{a_{i0} + a_{i1}f + a_{i2}f^2}{f}$$

with V_i = linearized voltage of channel i (i = x,y,z)

Norm_i = sensor sensitivity of channel i (i = x,y,z)

$\mu\text{V}/(\text{V/m})^2$ for E-field Probes

ConvF = sensitivity enhancement in solution

a_{ij} = sensor sensitivity factors for H-field probes

f = carrier frequency [GHz]

E_i = electric field strength of channel i in V/m

H_i = magnetic field strength of channel i in A/m

The RMS value of the field components gives the total field strength (Hermitian magnitude):

$$E_{tot} = \sqrt{E_x^2 + E_y^2 + E_z^2}$$

The primary field data are used to calculate the derived field units.

$$SAR = E_{tot}^2 \cdot \frac{\sigma}{\rho \cdot 1'000}$$

with SAR = local specific absorption rate in mW/g

E_{tot} = total field strength in V/m

σ = conductivity in [mho/m] or [Siemens/m]

ρ = equivalent tissue density in g/cm^3

Note that the density is set to 1, to account for actual head tissue density rather than the density of the tissue simulating liquid.

Spatial Peak SAR for 1 g and 10 g

The DASY5 software includes all numerical procedures necessary to evaluate the spatial peak SAR values. The base for the evaluation is a "cube" measurement at the points of the fine cube grid consisting of 5 x 5 x 7 points (with 8mm horizontal resolution) or 7 x 7 x 7 points (with 5mm horizontal resolution) or 8 x 8 x 7 points (with 4mm horizontal resolution). The entire evaluation of the spatial peak values is performed within the Postprocessing engine (SEMCAD X). The system always gives the maximum values for the 1 g and 10 g cubes.

The algorithm to find the cube with highest averaged SAR is divided into the following stages:

1. extraction of the measured data (grid and values) from the Zoom Scan.
2. calculation of the SAR value at every measurement point based on all stored data (A/D values and measurement parameters).
3. generation of a high-resolution mesh within the measured volume.
4. interpolation of all measured values from the measurement grid to the high-resolution grid
5. extrapolation of the entire 3-D field distribution to the phantom surface over the distance from sensor to surface.
6. calculation of the averaged SAR within masses of 1 g and 10 g.

4.3 Data Storage and Evaluation

The DASY5 installation includes predefined files with recommended procedures for measurements and validation. All test positions (head or body-worn) are tested with the same configuration of test steps differing only in the grid definition for the different test positions.

Step 1: Power reference measurement

The Power Reference Measurement and Power Drift Measurement are for monitoring the power drift of the device under test in the batch process. The Minimum distance of probe sensors to surface determines the closest measurement point to phantom surface. By default, the Minimum distance of probe sensors to surface is 4 mm.

This distance can be modified by the user, but cannot be smaller than the Distance of sensor calibration points to probe tip as defined in the probe properties. The SAR measurement was taken at a selected spatial reference point to monitor power variations during testing. This fixed location point was measured and used as a reference value.

Step 2: Area Scan

The Area Scan is used as a fast scan in two dimensions to find the area of high field values, before doing a finer measurement around the hotspot. The sophisticated interpolation routines implemented in DASY5 software can find the maximum locations even in relatively coarse grids. When an Area Scan has measured all reachable points, it computes the field maxima found in the scanned area, within a range of the global maximum. The range (in dB) is specified in the standards for compliance testing. For example, a 2 dB range is required in IEEE 1528-2003 and IEC 62209 standards, whereby 3 dB is a requirement when compliance is assessed in accordance with the ARIB standard (Japan). If only one Zoom Scan follows the Area Scan, then only the absolute maximum will be taken as reference. For cases where multiple maximums are detected, the number of Zoom Scans has to be increased accordingly.

Step 3: Zoom Scan

The Zoom Scans are used to assess the peak spatial SAR values within a cubic averaging volume containing 1 gram and 10 gram of simulated tissue. The default Zoom Scan is defined in the following table. DASY5 is also able to perform repeated zoom scans if more than 1 peak is found during area scan. When the measurement is done, the Zoom Scan evaluates the averaged SAR for 1 gram and 10 gram and displays these values next to the job's label.

Area scan and Zoom scan resolutions per FCC KDB Publication 865664 D01:

Frequency	Maximun Area Scan resolution ($\Delta x_{Area}, \Delta y_{Area}$)	Maximun Zoom Scan spatial resolution ($\Delta x_{Zoom}, \Delta y_{Zoom}$)	Maximun Zoom Scan spatial resolution			Minimum zoom scan volume (x,y,z)
			Uniform Grid	Graded Grad		
			$\Delta z_{Zoom}(n)$	$\Delta z_{Zoom}(1)^*$	$\Delta z_{Zoom}(n>1)^*$	
≤ 2GHz	≤ 15mm	≤ 8mm	≤ 5mm	≤ 4mm	$\leq 1.5 * \Delta z_{Zoom}(n-1)$	≥ 30mm
2-3GHz	≤ 12mm	≤ 5mm	≤ 5mm	≤ 4mm	$\leq 1.5 * \Delta z_{Zoom}(n-1)$	≥ 30mm
3-4GHz	≤ 12mm	≤ 5mm	≤ 4mm	≤ 3mm	$\leq 1.5 * \Delta z_{Zoom}(n-1)$	≥ 28mm
4-5GHz	≤ 10mm	≤ 4mm	≤ 3mm	≤ 2.5mm	$\leq 1.5 * \Delta z_{Zoom}(n-1)$	≥ 25mm
5-6GHz	≤ 10mm	≤ 4mm	≤ 2mm	≤ 2mm	$\leq 1.5 * \Delta z_{Zoom}(n-1)$	≥ 22mm

Step 4: Power Drift Monitoring

The Power Drift Measurement measures the field at the same location as the most recent power reference measurement job within the same procedure, and with the same settings. The Power Drift Measurement gives the field difference in dB from the reading conducted within the last Power Reference Measurement. If the value changed by more than 5%, the evaluation should be retested.

5 SAR Verification Procedure

5.1 Tissue Verification

The following materials are used for producing the tissue-equivalent materials.
(Liquids used for tests are marked with☒):

Ingredients (% of weight)	Frequency (MHz)						
	Head Tissue						
Tissue Type	☒ 835	☐ 1750	☒ 1900	☐ 2300	☐ 2450	☐ 2600	☐ 5200-5800
frequency band	☒ 835	☐ 1750	☒ 1900	☐ 2300	☐ 2450	☐ 2600	☐ 5200-5800
Water	41.45	52.64	55.242	62.82	62.7	55.242	65.52
Salt (NaCl)	1.45	0.36	0.306	0.51	0.5	0.306	0.0
Sugar	56.0	0.0	0.0	0.0	0.0	0.0	0.0
HEC	1.0	0.0	0.0	0.0	0.0	0.0	0.0
Bactericide	0.1	0.0	0.0	0.0	0.0	0.0	0.0
Triton X-100	0.0	0.0	0.0	0.0	36.8	0.0	17.24
DGBE	0.0	47.0	44.542	36.67	0.0	44.452	0.0
Diethylenglycol monohexylether	0.0	0.0	0.0	0.0	0.0	0.0	17.24

Salt: 99+% Pure Sodium Chloride

Sugar: 98+% Pure Sucrose

Water: De-ionized, 16MΩ+ resistivity

HEC: Hydroxyethyl Cellulose

DGBE: 99+% Di(ethylene glycol) butyl ether, [2-(2-butoxyethoxy)ethanol]

Triton X-100(ultra pure): Polyethylene glycol mono [4-(1,1,3,3-tetramethylbutyl)phenyl]ether

Tissue simulating liquids: parameters:

Tissue Type	Measured Frequency (MHz)	Target Tissue		Measured Tissue		Liquid Temp.	Test Date
		ϵ_r (+/-5%)	σ (S/m) (+/-5%)	ϵ_r	σ (S/m)		
835 Head	825	41.60 (39.52~43.68)	0.90 (0.86~0.95)	41.860	0.881	20.18°C	10/25/2022
	835	41.50 (39.43~43.58)	0.90 (0.86~0.95)	41.762	0.886		
	850	41.50 (39.43~43.58)	0.92 (0.87~0.96)	41.700	0.897		
1900 Head	1850	40.00 (38.00~42.00)	1.40 (1.33~1.47)	38.370	1.351	20.55°C	11/16/2022
	1880	40.00 (38.00~42.00)	1.40 (1.33~1.47)	38.300	1.382		
	1900	40.00 (38.00~42.00)	1.40 (1.33~1.47)	38.270	1.406		
	1910	40.00 (38.00~42.00)	1.40 (1.33~1.47)	38.220	1.413		

ϵ_r = Relative permittivity, σ = Conductivity

5.2 System check procedure

The System check is performed by using a System check dipole which is positioned parallel to the planar part of the SAM phantom at the reference point. The distance of the dipole to the SAM phantom is determined by a spacer. The dipole is connected to the signal source consisting of signal generator and amplifier via a directional coupler, N-connector cable and adaption to SMA. It is fed with a power of 250mW. To adjust this power a power meter is used. The power sensor is connected to the cable before the System check to measure the power at this point and do adjustments at the signal generator. At the outputs of the directional coupler both return loss as well as forward power are controlled during the validation to make sure that emitted power at the dipole is kept constant. This can also be checked by the power drift measurement after the test (result on plot).

System check results have to be equal or near the values determined during dipole calibration (target SAR in table above) with the relevant liquids and test system.

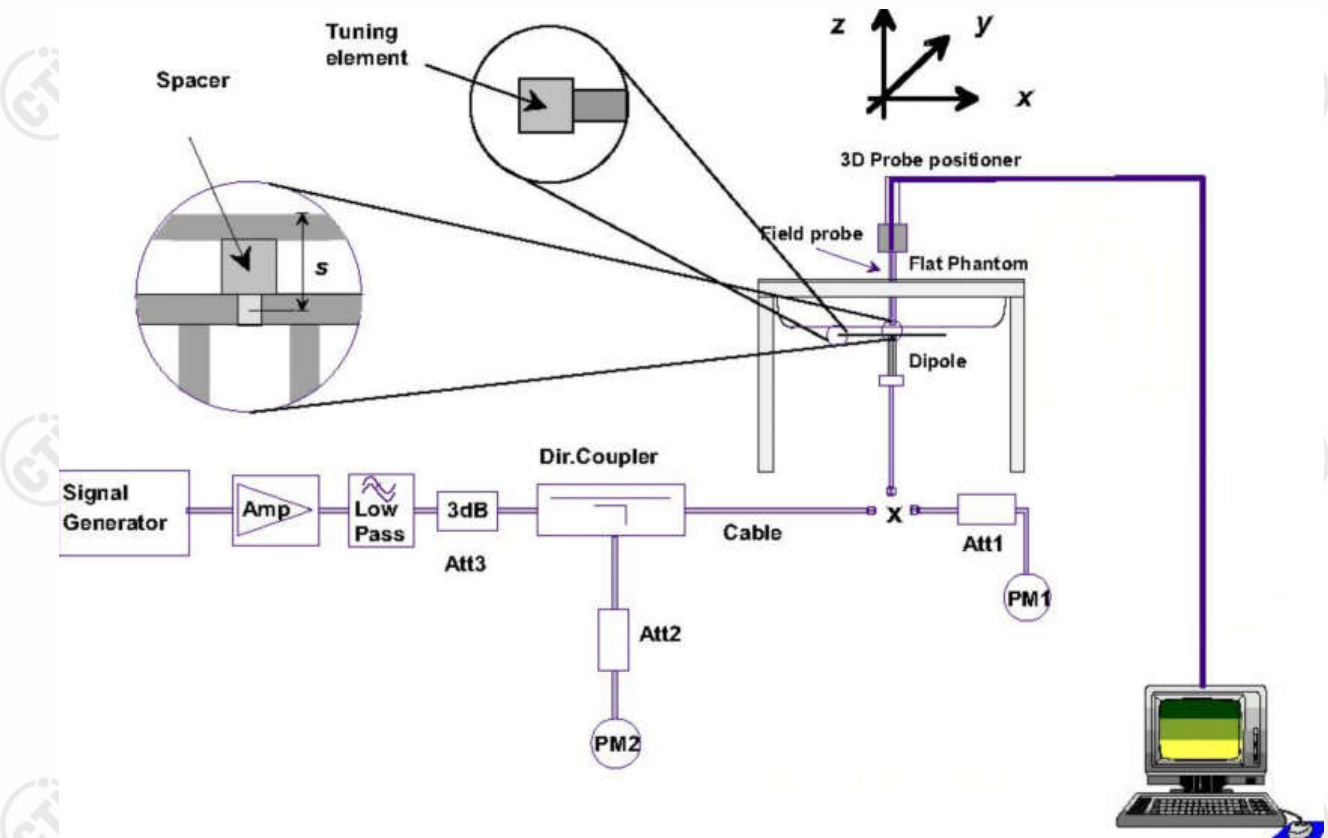

5.3 System check results

The system Check is performed for verifying the accuracy of the complete measurement system and performance of the software. The following table shows System check results for all frequency bands and tissue liquids used during the tests (plot(s) see annex A).

System Check						
Tissue Type	Target SAR 1W (+/-10%)		Measured SAR		Liquid Temp.	Test Date
	1g(mW/g)	10g(mW/g)	1g(mW/g)	10g(mW/g)		
D835V2 Head	9.48 (8.53~10.43)	6.28 (5.65~6.91)	9.960	6.60	20.18°C	10/25/2022
D1900V2 Head	39.60 (35.64~43.56)	21.40 (19.26~23.54)	38.920	20.52	20.55°C	11/16/2022

6 SAR Measurement variability and uncertainty

6.1 SAR measurement variability

In accordance with published RF Exposure KDB procedure 865664 D01 SAR measurement 100 MHz to 6 GHz v01r04. These additional measurements are repeated after the completion of all measurements requiring the same head or body tissue-equivalent medium in a frequency band. The test device should be returned to ambient conditions (normal room temperature) with the battery fully charged before it is re-mounted on the device holder for the repeated measurement(s) to minimize any unexpected variations in the repeated results. The same procedures should be adapted for measurements according to extremity exposure limits by applying a factor of 2.5 for extremity exposure.

- 1) Repeated measurement is not required when the original highest measured SAR is < 2.0 W/kg; steps 2) through 4) do not apply.
- 2) When the original highest measured SAR is ≥ 2.0 W/kg, repeat that measurement once.
- 3) Perform a second repeated measurement only if the ratio of largest to smallest SAR for the original and first repeated measurements is > 3.0 or when the original or repeated measurement is ≥ 3.6 W/kg (~ 10% from the 10-g SAR limit).
- 4) Perform a third repeated measurement only if the original, first or second repeated measurement is ≥ 3.75 W/kg and the ratio of largest to smallest SAR for the original, first and second repeated measurements is > 1.20 .

6.2 SAR measurement uncertainty

Per KDB865664 D01 SAR Measurement 100 MHz to 6 GHz v01r04, when the highest measured 1-g SAR within a frequency band is < 1.5 W/kg, the extensive SAR measurement uncertainty analysis described in IEEE Std 1528-2013 is not required in SAR reports submitted for equipment approval. The equivalent ratio (1.5/1.6) is applied to extremity and occupational exposure conditions.

7 SAR Test Configuration

7.1 GSM Test Configurations

SAR tests for GSM850 and GSM1900, a communication link is set up with a base station by air link. Using CMU200 the power level is set to “5”and “0” in SAR of GSM850 and GSM1900. The tests in the band of GSM850 and GSM1900 are performed in the mode of GPRS/EGPRS function. Since the GPRS/EGPRS class is 12 for this EUT, it has at most 4 timeslots in uplink and at most 4 timeslots in downlink, the maximum total timeslot is 5.

When SAR tests for EGPRS mode is necessary, GMSK modulation should be used to minimize SAR measurement error due to higher peak-to-average power (PAR) ratios inherent in 8-PSK.

8 SAR Test Results

8.1 Conducted Power Measurements

- 1.For the measurements a Rohde & Schwarz Radio Communication Tester CMU200 was used.
- 2.Establish communication link between emulator and EUT and set EUT to operate at maximum output power all the time.
- 3.Source-based Time Averaged Burst Power Calculation:
For TDMA,the following duty cycle factor was used to calculate the Source-based Time Averaged power.

Number of Time slot	1	2	3	4
Duty cycle	1:8.3	1:4.1	1:2.77	1:2.08
Duty cycle factor	-9.19	-6.13	-4.42	-3.18

8.1.1 Conducted Power of GSM850

GSM850		Burst-Averaged output Power (dBm)			Division Factors	Source Based time Average Power(dBm)		
		128CH	190CH	251CH		128CH	190CH	251CH
GPRS/ EDGE (GMSK)	1 Tx Slot	33.72	33.14	32.29	-9.19	24.53	23.95	23.10
	2 Tx Slots	31.65	31.18	30.54	-6.13	25.52	25.05	24.41
	3 Tx Slots	29.32	28.94	28.55	-4.42	24.90	24.52	24.13
	4 Tx Slots	27.90	27.61	27.30	-3.18	24.72	24.43	24.12

Note: 1) The conducted power of GSM850 is measured with RMS detector.

2) Source Based time Average Power was calculated from the measured burst-averaged output power by converting the slot powers into linear units and calculating the energy over 8 timeslots.

3) The bolded GPRS 4Tx slots mode was selected for SAR testing according the highest Source Based time Average Power table.

4) channel/Frequency: 128/824.2,190/836.6,251/848.8

8.1.2 Conducted Power of GSM1900

GSM1900		Burst-Averaged output Power (dBm)			Division Factors	Source Based time Average Power(dBm)		
		512CH	661CH	810CH		512CH	661CH	810CH
GPRS/ EDGE (GMSK)	1 Tx Slot	30.91	30.15	30.79	-9.19	21.72	20.96	21.60
	2 Tx Slots	30.48	28.88	29.40	-6.13	24.35	22.75	23.27
	3 Tx Slots	29.31	27.98	28.58	-4.42	24.89	23.56	24.16
	4 Tx Slots	28.27	26.97	27.88	-3.18	25.09	23.79	24.70

Note: 1) The conducted power of GSM1900 is measured with RMS detector.

2) Source Based time Average Power was calculated from the measured burst-averaged output power by converting the slot powers into linear units and calculating the energy over 8 timeslots.

3) The bolded GPRS 4Tx slots mode was selected for SAR testing according the highest Source Based time Average Power table.

4) channel/Frequency: 512/1850.2,661/1880,810/1909.8

8.1.3 Conducted Power of BT

The output power of BT antenna is as following:

For BT 4.0:

Average Conducted Power(dBm)			
Channel	0CH	19CH	39CH
BT	-0.15	-0.18	-0.68

Note: channel /Frequency: 0/2402, 19/2440, 39/2480.

8.2 SAR test results

Notes:

1) Per KDB447498 D01v06, testing of other required channels within the operating mode of a frequency band is not required when the reported 1-g or 10-g SAR for the mid-band or highest output power channel is: ≤ 0.8 W/kg or 2.0 W/kg, for 1-g or 10-g respectively, when the transmission band is ≤ 100 MHz. When the maximum output power variation across the required test channels is $> \frac{1}{2}$ dB, instead of the middle channel, the highest output power channel must be used.

2) Per KDB447498 D01v06, All measurement SAR result is scaled-up to account for tune-up tolerance is compliant.

3) Per KDB865664 D01v01r04, for each frequency band, repeated SAR measurement is required only when the measured SAR is ≥ 0.8 W/Kg; if the deviation among the repeated measurement is $\leq 20\%$, and the measured SAR < 1.45 W/Kg, only one repeated measurement is required.

4) Per KDB865664 D02v01r02, SAR plot is only required for the highest measured SAR in each exposure configuration, wireless mode and frequency band combination; Plots are also required when the measured SAR is > 1.5 W/kg, or > 7.0 W/kg for occupational exposure. The same procedures should be adapted for measurements according to extremity exposure limits by applying a factor of 2.5 for extremity exposure. The published RF exposure KDB procedures may require additional plots; for example, to support SAR to peak location separation ratio test exclusion and/or volume scan post-processing (Refer to appendix B for details).

5) Per KDB941225 D06, the DUT Dimension is bigger than 9 cm x 5 cm, so 10mm is chosen as the test separation distance for Hotspot mode. When the antenna-to-edge distance is greater than 2.5cm, such position does not need to be tested.

6) Per KDB648474 D04, SAR is evaluated without a headset connected to the device. When the standalone reported body-worn SAR is ≤ 1.2 W/kg, no additional SAR evaluations using a headset are required.

8.2.1 Results overview of GSM850

Test Position of Limbs With 0 mm	channel/ Frequency	Test Mode	SAR Value (W/Kg)		Power Drift(dB)	Conducted Power(dBm)	Tune up Power(dBm)	Scaled SAR1-g(W/kg)	Liquid Temp.
			1-g	10-g					
Position 1	128/824.2	GPRS 2TS	2.020	0.541	-0.220	31.65	32.00	2.190	20.18°C
Position 1	190/836.6	GPRS 2TS	2.010	0.539	-0.820	31.18	32.00	2.428	20.18°C
Position 1	251/848.8	GPRS 2TS	1.840	0.489	-0.310	30.54	32.00	2.575	20.18°C
Position 1 Repeated	128/824.2	GPRS 2TS	2.070	0.554	-0.040	31.65	32.00	2.244	20.18°C
Position 1 Repeated	190/836.6	GPRS 2TS	2.030	0.543	0.240	31.18	32.00	2.452	20.18°C
Position 1 Repeated	251/848.8	GPRS 2TS	1.850	0.497	-0.170	30.54	32.00	2.589	20.18°C

Note:

1) The maximum SAR value of each test band is shown in **bold** letters.

8.2.2 Results overview of GSM1900

Test Position of Limbs With 0 mm	channel/ Frequency	Test Mode	SAR Value (W/Kg)		Power Drift(dB)	Conducted Power(dBm)	Tune up Power(dBm)	Scaled SAR1-g(W/kg)	Liquid Temp.
			1-g	10-g					
Position 1	512/1850.2	GPRS 4TS	0.927	0.282	0.000	28.27	28.50	0.977	20.55°C
Position 1	661/1880	GPRS 4TS	0.545	0.187	0.000	26.97	28.50	0.775	20.55°C
Position 1	810/1909.8	GPRS 4TS	0.522	0.169	0.000	27.88	28.50	0.602	20.55°C
Position 1 Repeated	512/1850.2	GPRS 4TS	0.639	0.242	0.000	28.27	28.50	0.674	20.55°C

Note:

1) The maximum SAR value of each test band is shown in **bold** letters.

8.3 Multiple Transmitter Information

The location of the antennas inside BFG1T s shown as below picture:

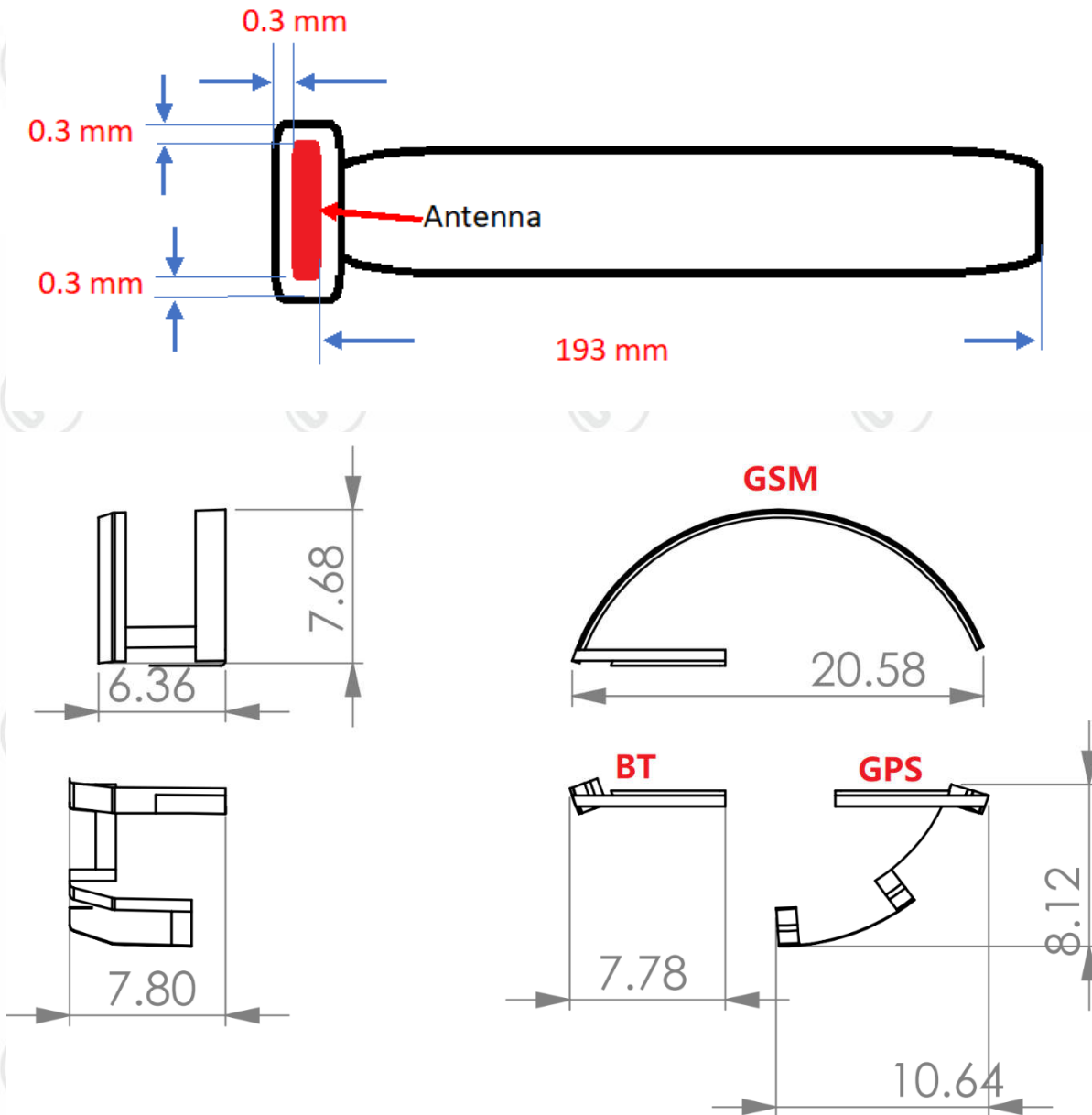

8.4 Stand-alone SAR

Per FCC KDB 447498D01:

- 1) The 1-g and 10-g SAR test exclusion thresholds for 100 MHz to 6 GHz at test separation distances ≤ 50 mm are determined by:

$$[(\text{max. power of channel, including tune-up tolerance, mW}) / (\text{min. test separation distance, mm})] \cdot [\sqrt{f(\text{GHz})}] \leq$$

3.0 for 1-g SAR and ≤ 7.5 for 10-g extremity SAR, where

- $f(\text{GHz})$ is the RF channel transmit frequency in GHz
- Power and distance are rounded to the nearest mW and mm before calculation
- The result is rounded to one decimal place for comparison

When the minimum test separation distance is < 5 mm, a distance of 5mm is applied to determine SAR test exclusion.

Mode	Position	P_{max} (dBm)	P_{max} (mW)	Distance (mm)	F (GHz)	Calculation Result	SAR test exclusion Threshold	SAR test exclusion
BT	Body	0.00	1.00	5.00	2.450	0.31	3.00	Yes

- 1) When the standalone SAR test exclusion applies to an antenna that transmits simultaneously with other antennas, the standalone SAR must be estimated according to the following to determine simultaneous transmission SAR test exclusion:

$$(\text{max. power of channel, including tune-up tolerance, mW}) / (\text{min. test separation distance, mm}) \cdot [\sqrt{f(\text{GHz})} / x]$$

W/kg for test separation distances ≤ 50 mm, where $x = 7.5$ for 1-g SAR and $x = 18.75$ for 10-g SAR.

When the minimum test separation distance is < 5 mm, a distance of 5 mm is applied to determine SAR test exclusion.

Mode	Position	P_{max} (dBm)	P_{max} (mW)	Distance(mm)	f(GHz)	X	Estimated SAR(W/Kg)
BT	Body	0.00	1.00	5.00	2.45	7.50	0.023

Note: 1) maximum possible output power (including tune-up tolerance) declared by manufacturer

2) Held to ear configurations are not applicable to Bluetooth for this device

8.5 Simultaneous Transmission analysis

The Simultaneous Transmission Possibilities of this device are as below:

Simultaneous Tx Combination	Configuration	Head	Limbs	Hotspot	product specific 10-g SAR
1	GSM + BT	N/A	Yes	N/A	N/A

8.6 SAR Summation Scenario

Test Position		2G Antenna SAR _{max}		BT Antenna SAR _{max}	$\Sigma 1-gSAR_{1-g}$	SPLSP
		GSM850	GSM1900	BT		
Limbs 0mm	Position 1	2.589	0.997	0.023	2.612	No

Note: Simultaneous Tx Combination of 2G antenna and BT.

8.7 Simultaneous Transmission Conclusion

The above numeral summed SAR results is sufficient to determine that simultaneous transmission cases will not exceed the SAR limit and therefore simultaneous transmission SAR with Volume Scans is not required per KDB 447498 D01v06, so the tested result is comply with the FCC limit.

Annex A: Appendix A: SAR System performance Check Plots

(Please See Appendix A)

Annex B: Appendix B: SAR Measurement results Plots

(Please See Appendix B)

Annex C: Appendix C: Calibration reports

(Please See Appendix C)

Annex D: Appendix D: Photo documentation

(Please See Appendix D)

The test report is effective only with both signature and specialized stamp, The result(s) shown in this report refer only to the sample(s) tested. Without written approval of CTI, this report can't be reproduced except in full.

——END OF REPORT——