



## Appendix - Internal Photographs of EUT Constructional Details

Model: SNT942W

Photo 1

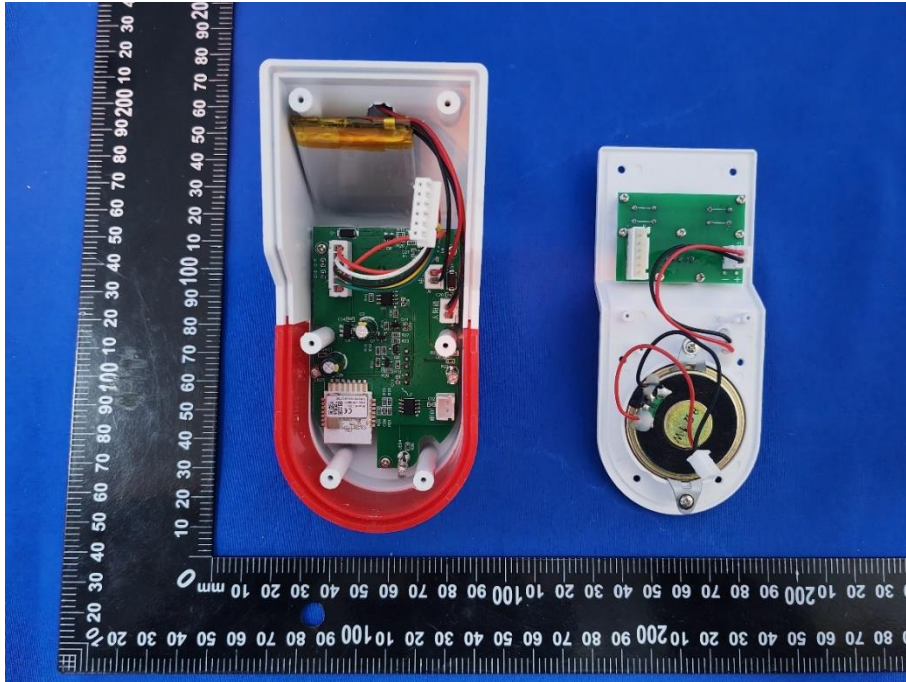

Photo 2

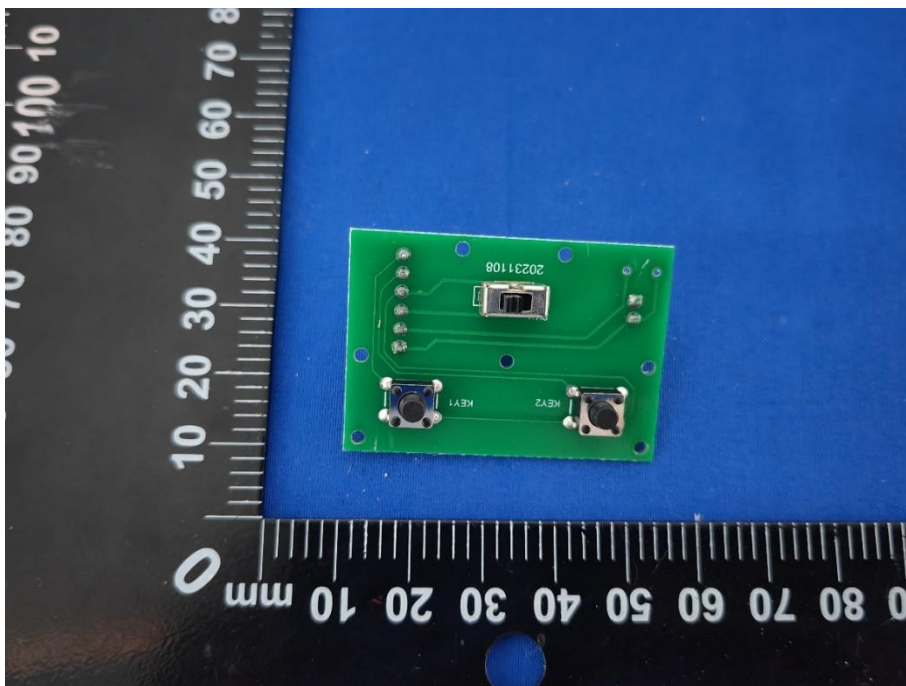



Photo 3

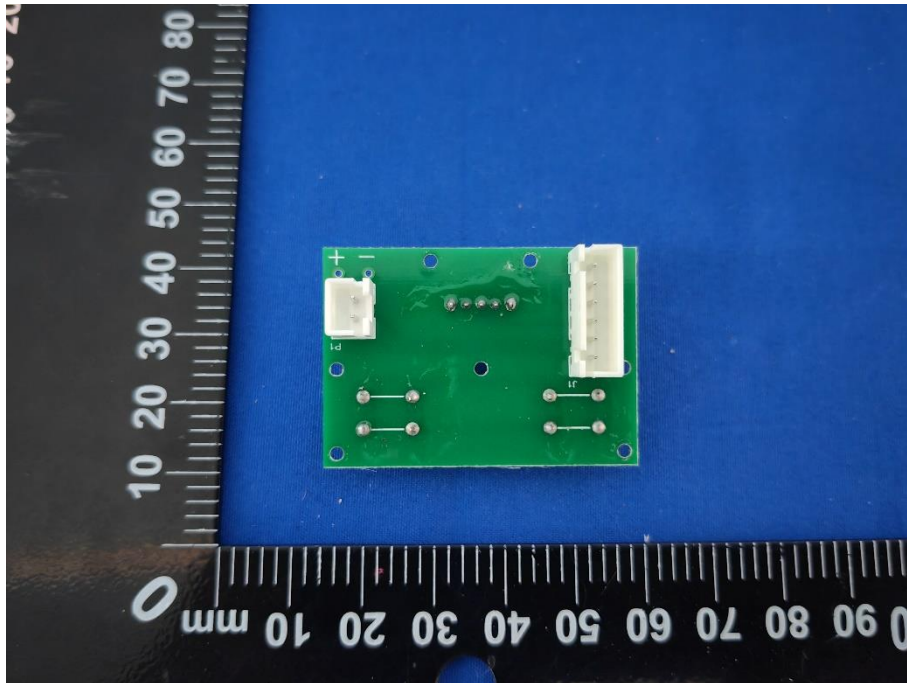

Photo 4

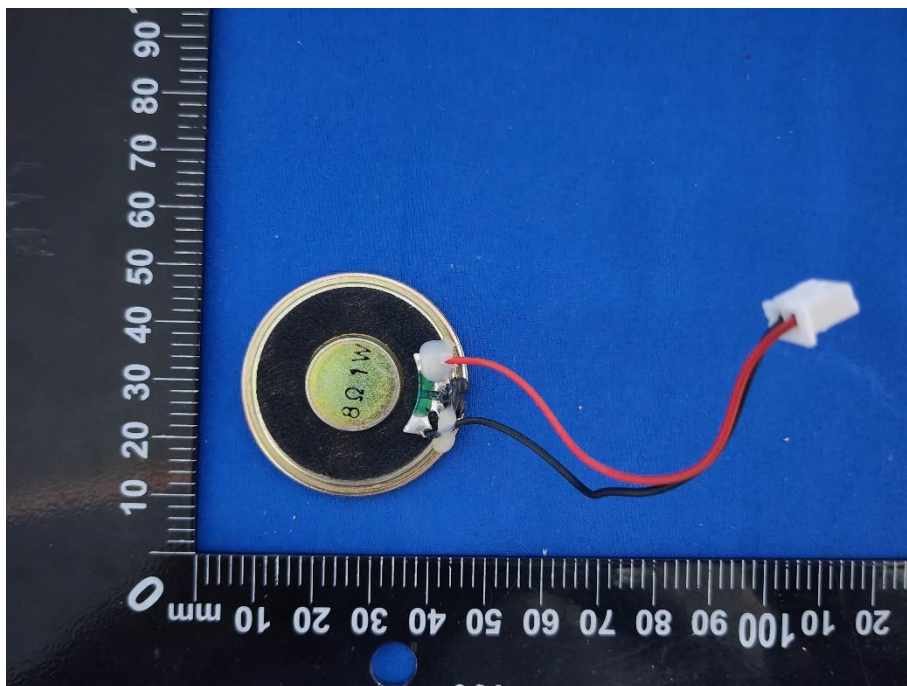



Photo 5

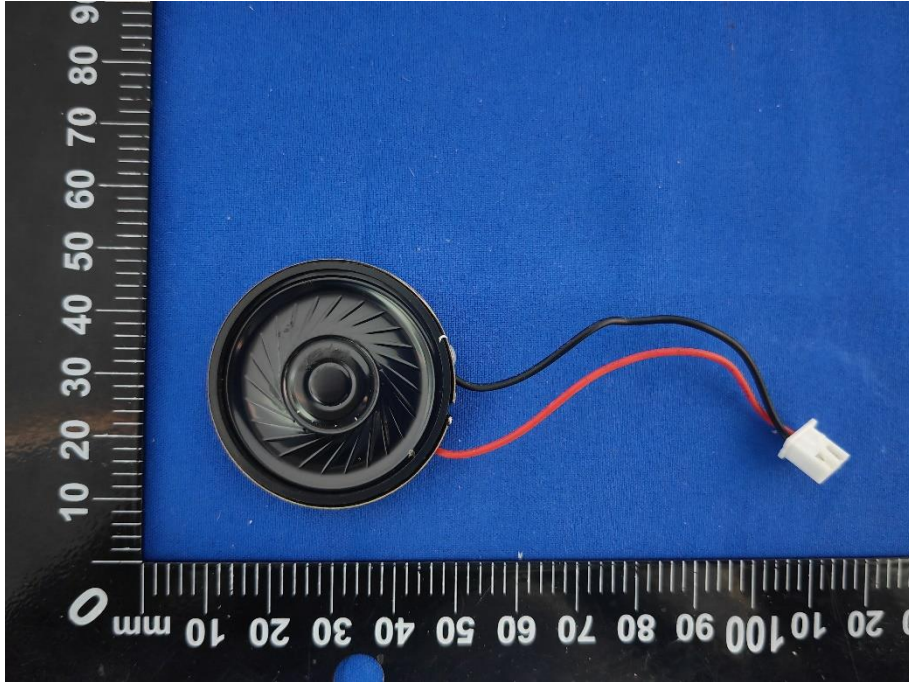

Photo 6

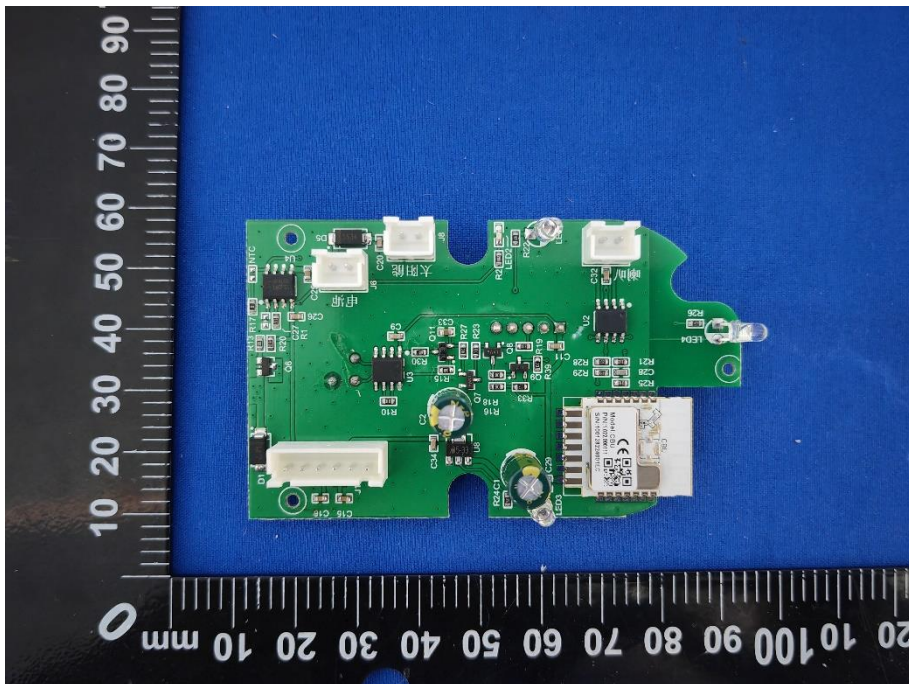



Photo 7

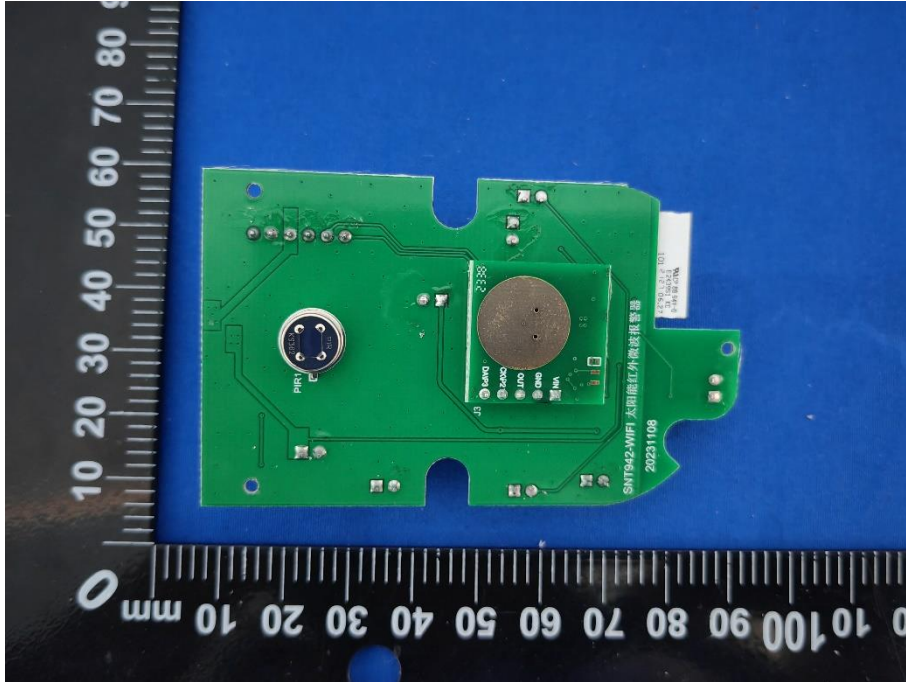

Photo 8

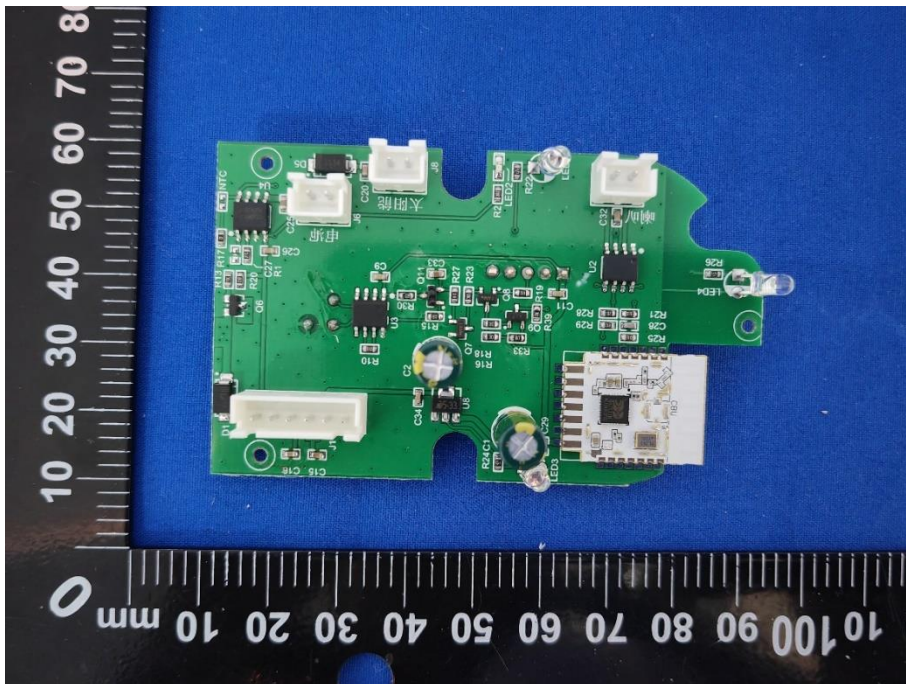



Photo 9

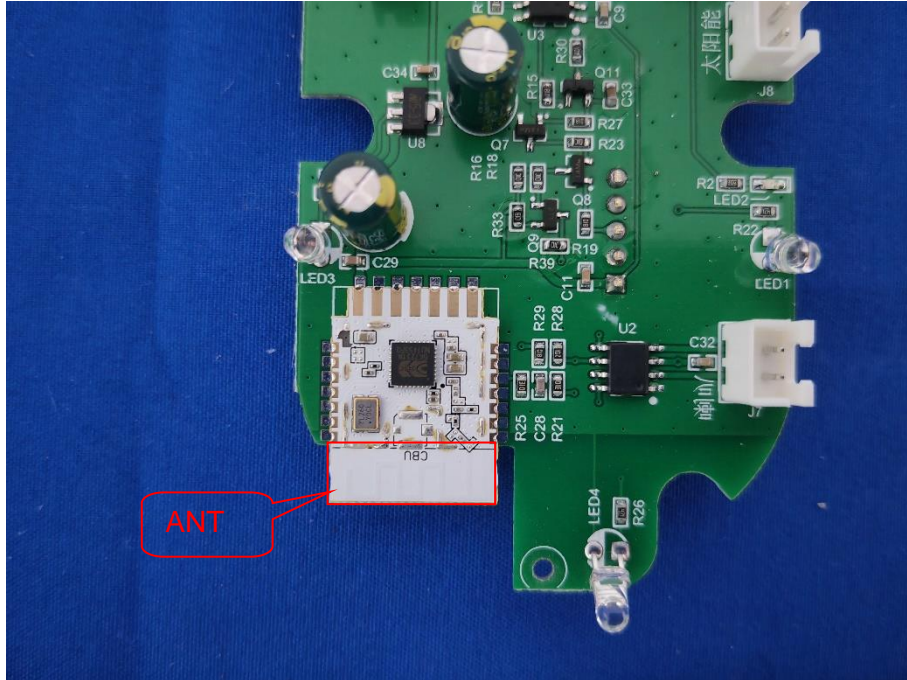

Photo 10

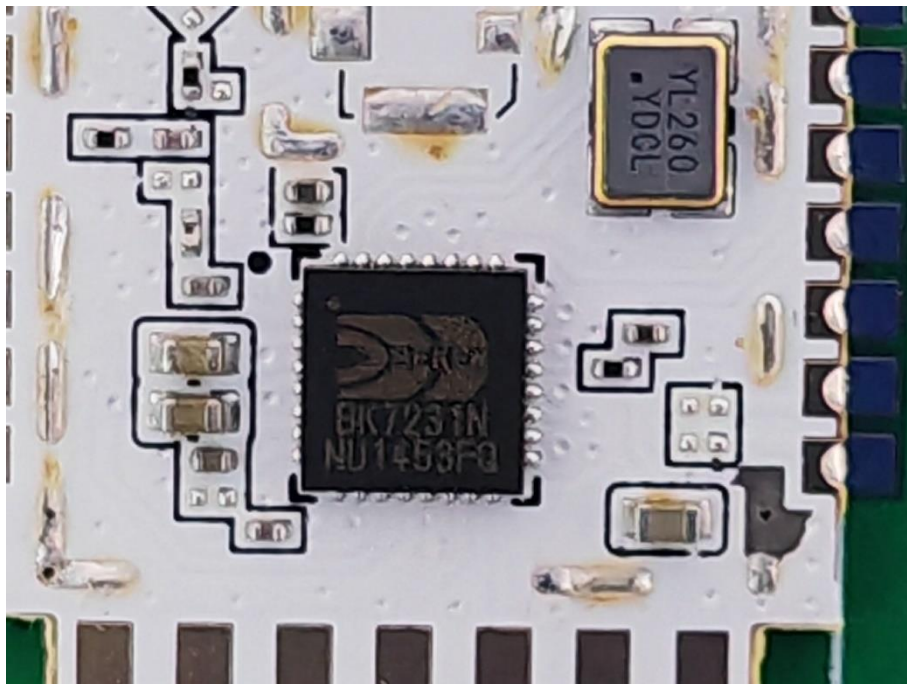



Photo 21

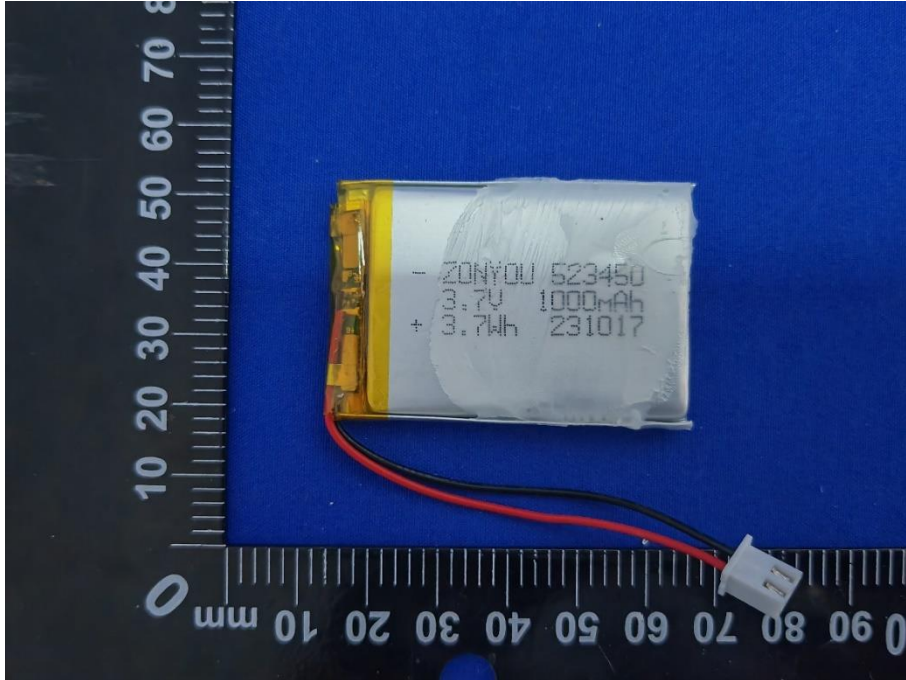

Photo 22

