

APPLICATION CERTIFICATION FCC Part 15C
On Behalf of
Dongguan Luxun Electronic Technology Co., Ltd

Bluetooth earphone

Model No.: BL1

FCC ID: 2ATRA-BL1

Prepared for : Dongguan Luxun Electronic Technology Co., Ltd
Address : No.8, Yongxing Road, Miaobianwang, Shipai Town, Dongguan,
China

Prepared by : Shenzhen Accurate Technology Co., Ltd.
Address : 1/F., Building A, Changyuan New Material Port, Science & Industry
Park, Nanshan District, Shenzhen, Guangdong, P.R. China

Tel: (0755) 26503290
Fax: (0755) 26503396

Report No. : ATE20191613
Date of Test : November 5-11, 2019
Date of Report : November 15, 2019

TABLE OF CONTENTS

Description	Page
Test Report Certification	
TABLE OF CONTENTS	2
1. GENERAL INFORMATION	5
1.1. Description of Device (EUT).....	5
1.2. Accessory and Auxiliary Equipment	5
1.3. Description of Test Facility	6
1.4. Measurement Uncertainty	6
2. MEASURING DEVICE AND TEST EQUIPMENT	7
3. OPERATION OF EUT DURING TESTING	8
3.1. Operating Mode	8
3.2. Configuration and peripherals	8
4. FREQUENCY HOPPING SYSTEM REQUIREMENTS	9
4.1. Standard and Limit	9
4.2. EUT Pseudorandom Frequency Hopping Sequence.....	9
5. TEST PROCEDURES AND RESULTS	10
6. 20DB BANDWIDTH TEST	11
6.1. Block Diagram of Test Setup.....	11
6.2. The Requirement For Section 15.247(a)(1).....	11
6.3. EUT Configuration on Measurement	11
6.4. Operating Condition of EUT	11
6.5. Test Procedure	11
6.6. Test Result	12
7. CARRIER FREQUENCY SEPARATION TEST	17
7.1. Block Diagram of Test Setup.....	17
7.2. The Requirement For Section 15.247(a)(1).....	17
7.3. EUT Configuration on Measurement	17
7.4. Operating Condition of EUT	17
7.5. Test Procedure	18
7.6. Test Result	18
8. NUMBER OF HOPPING FREQUENCY TEST	24
8.1. Block Diagram of Test Setup.....	24
8.2. The Requirement For Section 15.247(a)(1)(iii).....	24
8.3. EUT Configuration on Measurement	24
8.4. Operating Condition of EUT	24
8.5. Test Procedure	24
8.6. Test Result	25
9. DWELL TIME TEST	27
9.1. Block Diagram of Test Setup.....	27
9.2. The Requirement For Section 15.247(a)(1)(iii).....	27
9.3. EUT Configuration on Measurement	27
9.4. Operating Condition of EUT	27
9.5. Test Procedure	27

9.6.	Test Result	28
10.	MAXIMUM PEAK OUTPUT POWER TEST	34
10.1.	Block Diagram of Test Setup.....	34
10.2.	The Requirement For Section 15.247(b)(1).....	34
10.3.	EUT Configuration on Measurement	34
10.4.	Operating Condition of EUT	34
10.5.	Test Procedure	34
10.6.	Test Result	35
11.	RADIATED EMISSION TEST	41
11.1.	Block Diagram of Test Setup.....	41
11.2.	The Limit For Section 15.247(d)	42
11.3.	Restricted bands of operation	44
11.4.	Configuration of EUT on Measurement	44
11.5.	Operating Condition of EUT	45
11.6.	Test Procedure	45
11.7.	Data Sample.....	46
11.8.	Test Results.....	46
12.	BAND EDGE COMPLIANCE TEST	59
12.1.	Block Diagram of Test Setup.....	59
12.2.	The Requirement For Section 15.247(d)	59
12.3.	EUT Configuration on Measurement	59
12.4.	Operating Condition of EUT	59
12.5.	Test Procedure	60
12.6.	Test Result	60
13.	AC POWER LINE CONDUCTED EMISSION TEST	71
13.1.	Block Diagram of Test Setup.....	71
13.2.	Power Line Conducted Emission Measurement Limits.....	72
13.3.	Configuration of EUT on Measurement	72
13.4.	Operating Condition of EUT	72
13.5.	Test Procedure	72
13.6.	Data Sample.....	73
13.7.	Test Results.....	73
14.	ANTENNA REQUIREMENT.....	76
14.1.	The Requirement	76
14.2.	Antenna Construction	76

Test Report Certification

Applicant : Dongguan Luxun Electronic Technology Co., Ltd
Manufacturer : Dongguan Luxun Electronic Technology Co., Ltd
EUT : Bluetooth earphone
Model No. : BL1

Measurement Procedure Used:

**FCC Rules and Regulations Part 15 Subpart C Section 15.247
ANSI C63.10: 2013**

The device described above is tested by Shenzhen Accurate Technology Co., Ltd. to determine the maximum emission levels emanating from the device. The maximum emission levels are compared to the FCC Part 15 Subpart C Section 15.247 limits. The measurement results are contained in this test report and Shenzhen Accurate Technology Co., Ltd. is assumed full responsibility for the accuracy and completeness of these measurements. Also, this report shows that the Equipment Under Test (EUT) is to be technically compliant with the FCC requirements.

This report applies to above tested sample only. This report shall not be reproduced in part without written approval of Shenzhen Accurate Technology Co., Ltd.

Date of Test : November 5-11, 2019
Date of Report : November 15, 2019

Prepared by : _____
(Bob Wang, Engineer)

Approved & Authorized Signer : _____
(Sean Liu, Manager)

Bob Wang



Sean Liu

1. GENERAL INFORMATION

1.1. Description of Device (EUT)

Model Number	:	BL1
Bluetooth version	:	V4.2
Frequency Range	:	2402MHz-2480MHz
Number of Channels	:	79
Antenna Gain(Max)	:	1dBi
Antenna type	:	Integral Antenna
Modulation mode	:	GFSK, $\pi/4$ DQPSK, 8DPSK
Power Supply	:	DC 3.7V (Powered by Lithium battery) or DC 5.0V (Powered by USB port)
Applicant	:	Dongguan Luxun Electronic Technology Co., Ltd
Address	:	No.8, Yongxing Road, Miaobianwang, Shipai Town, Dongguan, China
Manufacturer	:	Dongguan Luxun Electronic Technology Co., Ltd
Address	:	No.8, Yongxing Road, Miaobianwang, Shipai Town, Dongguan, China

1.2. Accessory and Auxiliary Equipment

AC/DC Power Adapter (provided by laboratory)	:	Model:BEK-QC-001 INPUT: 120V~60Hz OUTPUT:5V/1A
---	---	--

1.3. Description of Test Facility

EMC Lab	:	Recognition of accreditation by Federal Communications Commission (FCC) The Designation Number is CN1189 The Registration Number is 708358
		Listed by Innovation, Science and Economic Development Canada (ISED) The Registration Number is 5077A-2
		Accredited by China National Accreditation Service for Conformity Assessment (CNAS) The Registration Number is CNAS L3193
		Accredited by American Association for Laboratory Accreditation (A2LA) The Certificate Number is 4297.01
Name of Firm	:	Shenzhen Accurate Technology Co., Ltd.
Site Location	:	1/F., Building A, Changyuan New Material Port, Science & Industry Park, Nanshan District, Shenzhen, Guangdong, P.R. China

1.4. Measurement Uncertainty

Radiated emission expanded uncertainty (9kHz-30MHz)	:	U=2.66dB, k=2
Radiated emission expanded uncertainty (30MHz-1000MHz)	:	U=4.28dB, k=2
Radiated emission expanded uncertainty (1G-18GHz)	:	U=4.98dB, k=2
Radiated emission expanded uncertainty (18G-26.5GHz)	:	U=5.06dB, k=2
Conduction Emission Expanded Uncertainty (Mains ports, 9kHz-30MHz)	:	U=2.72dB, k=2
Conduction Emission Expanded Uncertainty (Telecommunication ports, 150kHz-30MHz)	:	U=2.94dB, k=2
Power disturbance Expanded Uncertainty	:	U=2.92dB, k=2
Harmonic current expanded uncertainty	:	U=0.512%, k=2

2. MEASURING DEVICE AND TEST EQUIPMENT

Table 1: List of Test and Measurement Equipment

Kind of equipment	Manufacturer	Type	S/N	Calibrated dates	Calibrated until
EMI Test Receiver	Rohde&Schwarz	ESCS30	100307	Jan. 05, 2019	1 Year
EMI Test Receiver	Rohde& Schwarz	ESR	101817	Jan. 05, 2019	1 Year
Spectrum Analyzer	Rohde&Schwarz	FSV40	101495	Jan. 05, 2019	1 Year
Pre-Amplifier	Rohde&Schwarz	CBLU1183540-01	3791	Jan. 05, 2019	1 Year
Loop Antenna	Schwarzbeck	FMZB1516	1516131	Jan. 05, 2019	1 Year
Bilog Antenna	Schwarzbeck	VULB9163	9163-323	Jan. 05, 2019	1 Year
Horn Antenna	Schwarzbeck	BBHA9120D	9120D-655	Jan. 05, 2019	1 Year
Horn Antenna	Schwarzbeck	BBHA9170	9170-359	Jan. 05, 2019	1 Year
LISN	Schwarzbeck	NSLK8126	8126431	Jan. 05, 2019	1 Year
Highpass Filter	Wainwright Instruments	WHKX3.6/18G-10S S	N/A	Jan. 05, 2019	1 Year
Band Reject Filter	Wainwright Instruments	WRCG2400/2485-2 375/2510-60/11SS	N/A	Jan. 05, 2019	1 Year
RF COAXIAL CABLE	SUHNER	N-5m(Frequency range:9KHz-26.5GHz)	NO.3	Jan. 05, 2019	1 Year
RF COAXIAL CABLE	SUHNER	N-5m(Frequency range:9KHz-26.5GHz)	NO.4	Jan. 05, 2019	1 Year
RF COAXIAL CABLE	SUHNER	N-1m(Frequency range:9KHz-26.5GHz)	NO.5	Jan. 05, 2019	1 Year
RF COAXIAL CABLE	SUHNER	N-1m(Frequency range:9KHz-26.5GHz)	NO.6	Jan. 05, 2019	1 Year
Temporary antenna connector	NTGS	14AE	N/A	Jan. 21, 2019	N/A

Note: The temporary antenna connector is soldered on the PCB board in order to perform conducted tests and this temporary antenna connector is listed in the equipment list.

3. OPERATION OF EUT DURING TESTING

3.1. Operating Mode

The mode is used: Transmitting mode
Low Channel: 2402MHz
Middle Channel: 2441MHz
High Channel: 2480MHz
Hopping

3.2. Configuration and peripherals

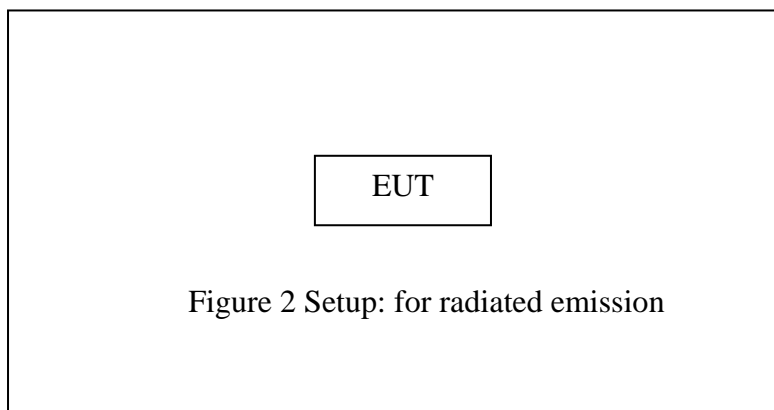
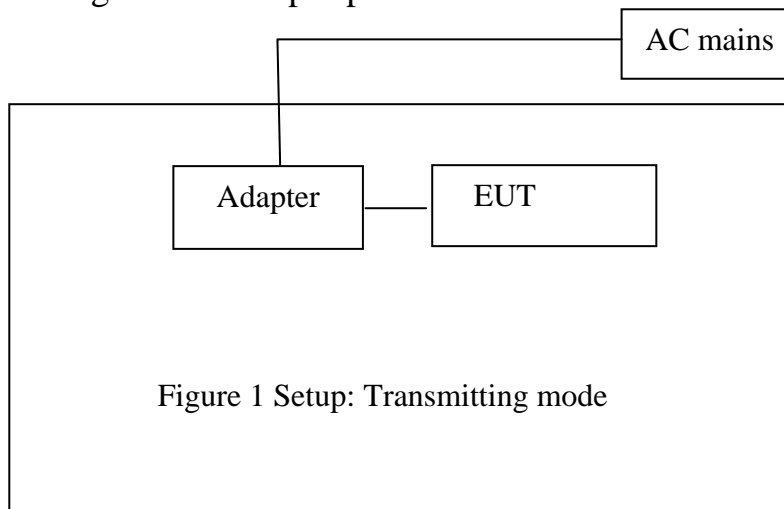

4. FREQUENCY HOPPING SYSTEM REQUIREMENTS

4.1. Standard and Limit

According to FCC Part 15.247(a)(1), The system shall hop to channel frequencies that are selected at the system hopping rate from a pseudo randomly ordered list of hopping frequencies. Each frequency must be used equally on the average by each transmitter. The system receivers shall have input bandwidths that match the hopping channel bandwidths of their corresponding transmitters and shall shift frequencies in synchronization with the transmitted signals.

(g) Frequency hopping spread spectrum systems are not required to employ all available hopping channels during each transmission. However, the system, consisting of both the transmitter and the receiver, must be designed to comply with all of the regulations in this section should the transmitter be presented with a continuous data (or information) stream. In addition, a system employing short transmission bursts must comply with the definition of a frequency hopping system and must distribute its transmissions over the minimum number of hopping channels specified in this section.

(h) The incorporation of intelligence within a frequency hopping spread spectrum system that permits the system to recognize other users within the spectrum band so that it individually and independently chooses and adapts its hop sets to avoid hopping on occupied channels is permitted. The coordination of frequency hopping systems in any other manner for the express purpose of avoiding the simultaneous occupancy of individual hopping frequencies by multiple transmitters is not permitted.

4.2. EUT Pseudorandom Frequency Hopping Sequence

Pseudorandom Frequency Hopping Sequence Table as below:

Channel: 08, 24, 40, 56, 34, 51, 72, 09, 01, 64, 22, 33, 41, 32, 47, 65, 73, 53, 69, 06, 17, 04, 20, 36, 52, 38, 66, 70, 78, 68, 76, 21, 29, 10, 26, 49, 00, 58, 44, 59, 75, 13, 03, 14, 11, 35, 43, 37, 50, 61, 77, 55, 71, 02, 23, 07, 27, 39, 54, 46, 48, 15, 63, 62, 67, 25, 31, 12, 28, 19, 60, 42, 57, 74, 16, 05, 18, 30, 45, etc.

The system receiving have input bandwidths that match the hopping channel bandwidths of their corresponding transmitters and shift frequencies in synchronization with the transmitted signals.

5. TEST PROCEDURES AND RESULTS

FCC Rules	Description of Test	Result
Section 15.247(a)(1)	20dB Bandwidth Test	Compliant
Section 15.247(a)(1)	Carrier Frequency Separation Test	Compliant
Section 15.247(a)(1)(iii)	Number Of Hopping Frequency Test	Compliant
Section 15.247(a)(1)(iii)	Dwell Time Test	Compliant
Section 15.247(b)(1)	Maximum Peak Output Power Test	Compliant
Section 15.247(d) Section 15.209	Radiated Emission Test	Compliant
Section 15.247(d)	Band Edge Compliance Test	Compliant
Section 15.207	AC Power Line Conducted Emissions Test	Compliant
Section 15.203	Antenna Requirement	Compliant

6. 20DB BANDWIDTH TEST

6.1. Block Diagram of Test Setup

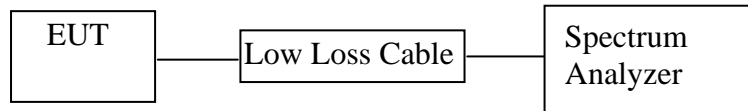

6.2. The Requirement For Section 15.247(a)(1)

Section 15.247(a)(1): Frequency hopping systems shall have hopping channel carrier frequencies separated by a minimum of 25 kHz or the 20 dB bandwidth of the hopping channel, whichever is greater.

6.3. EUT Configuration on Measurement

The equipment are installed on the emission measurement to meet the commission requirements and operating regulations in a manner which tends to maximize its emission characteristics in normal application.

6.4. Operating Condition of EUT

6.4.1. Setup the EUT and simulator as shown as Section 5.1.

6.4.2. Turn on the power of all equipment.

6.4.3. Let the EUT work in TX (Hopping off) modes measure it. The transmit frequency are 2402-2480MHz. We select 2402MHz, 2441MHz, and 2480MHz TX frequency to transmit.

6.5. Test Procedure

6.5.1. The transmitter output was connected to the spectrum analyzer through a low loss cable.

6.5.2. Set RBW of spectrum analyzer to 30 kHz and VBW to 100 kHz.

6.5.3. The 20dB bandwidth is defined as the total spectrum the power of which is higher than peak power minus 20dB.

6.6. Test Result

Channel	Frequency (MHz)	GFSK 20dB Bandwidth (MHz)	$\Pi/4$ -DQPSK 20dB Bandwidth (MHz)	8DPSK 20dB Bandwidth (MHz)	Result
Low	2402	0.978	1.356	1.356	Pass
Middle	2441	0.978	1.356	1.356	Pass
High	2480	0.978	1.362	1.356	Pass

The spectrum analyzer plots are attached as below.

GFSK Mode

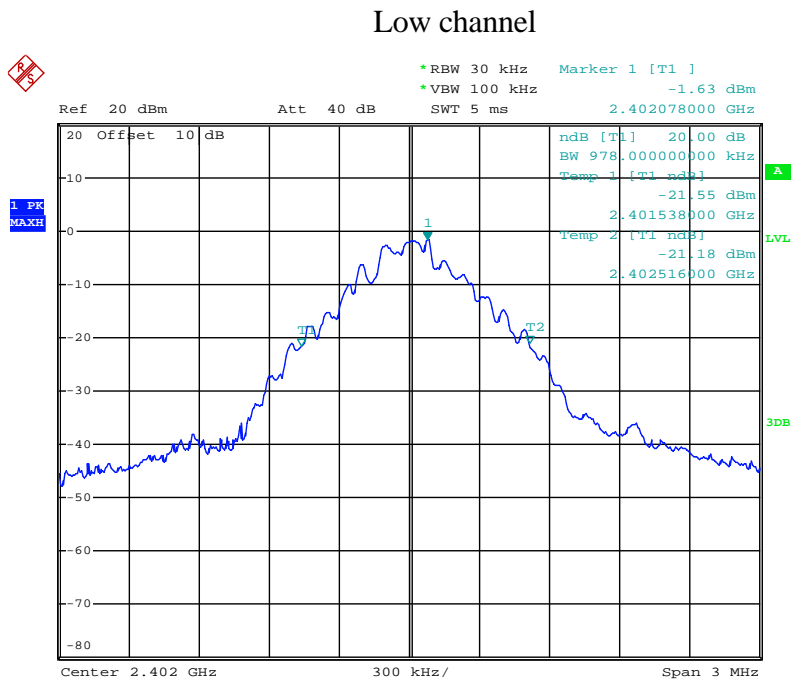

Middle channel

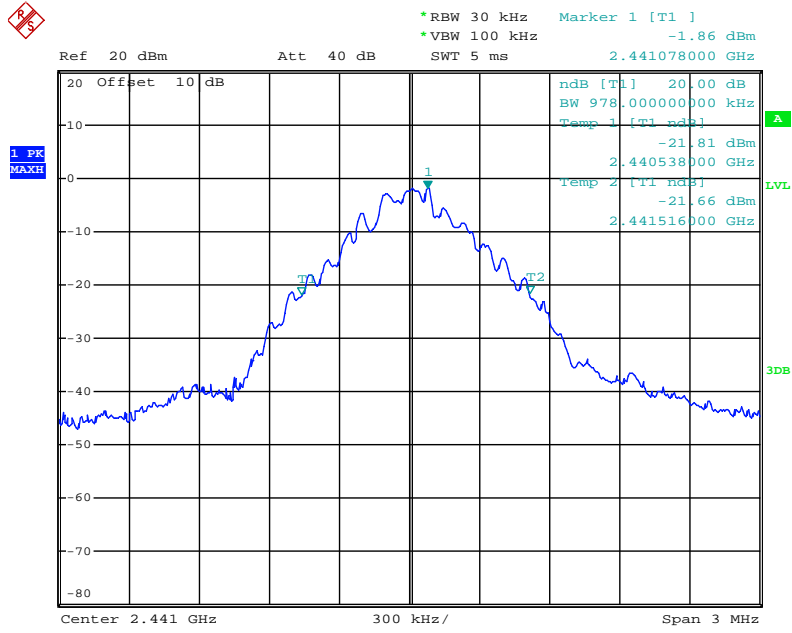

High channel

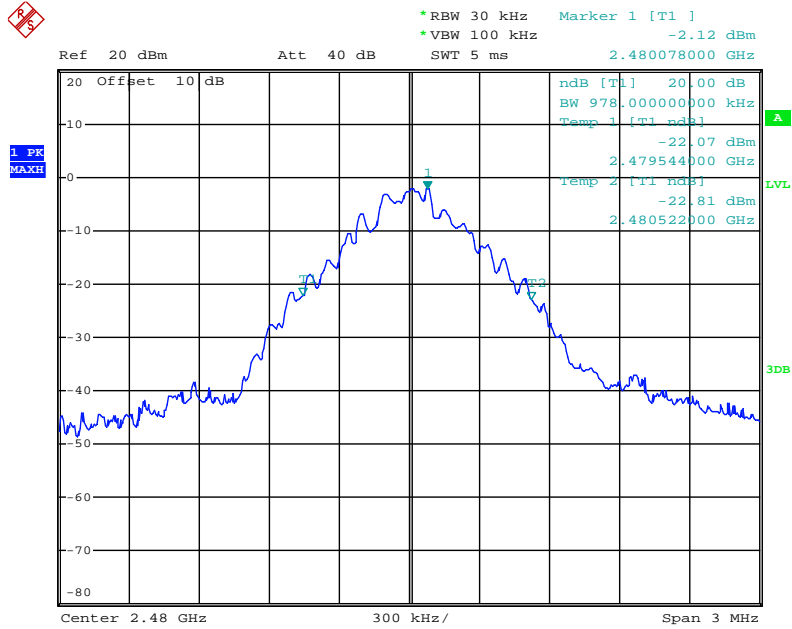

Π/4-DQPSK Mode

Low channel

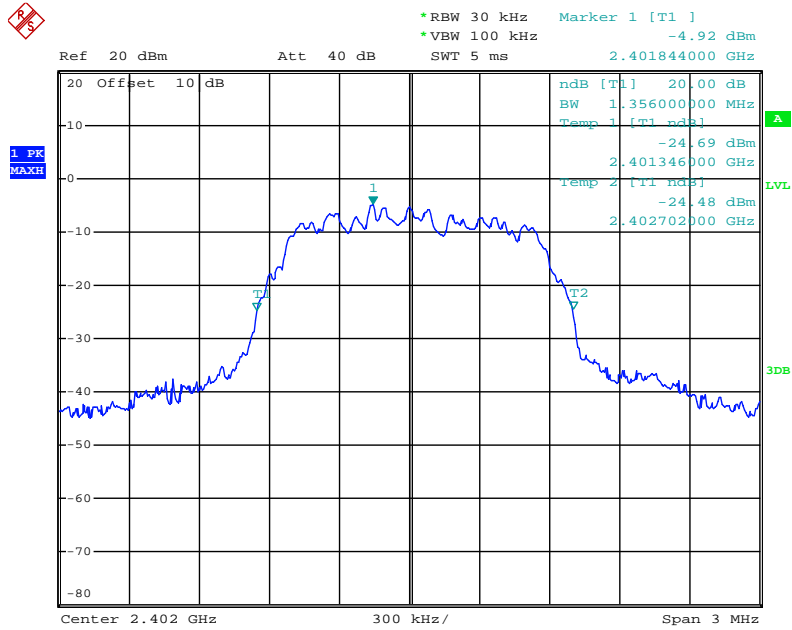

Middle channel

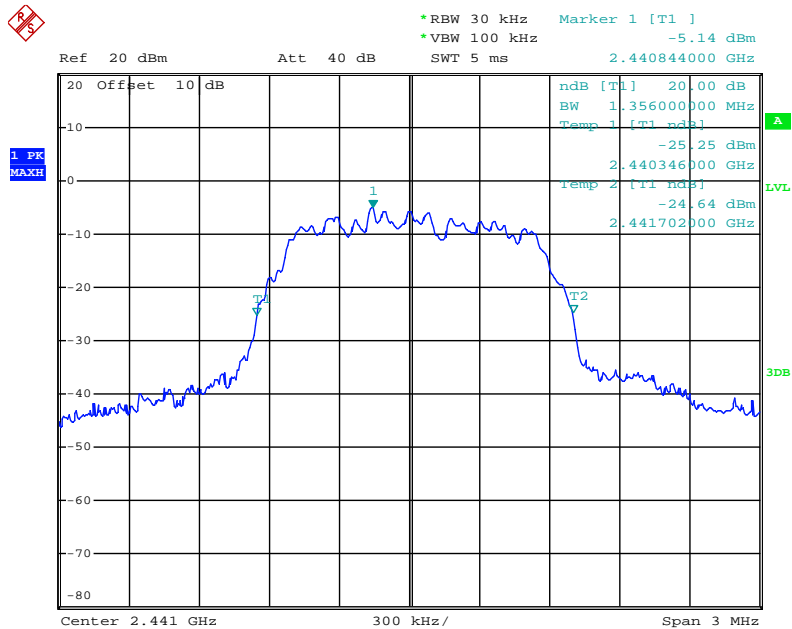

High channel

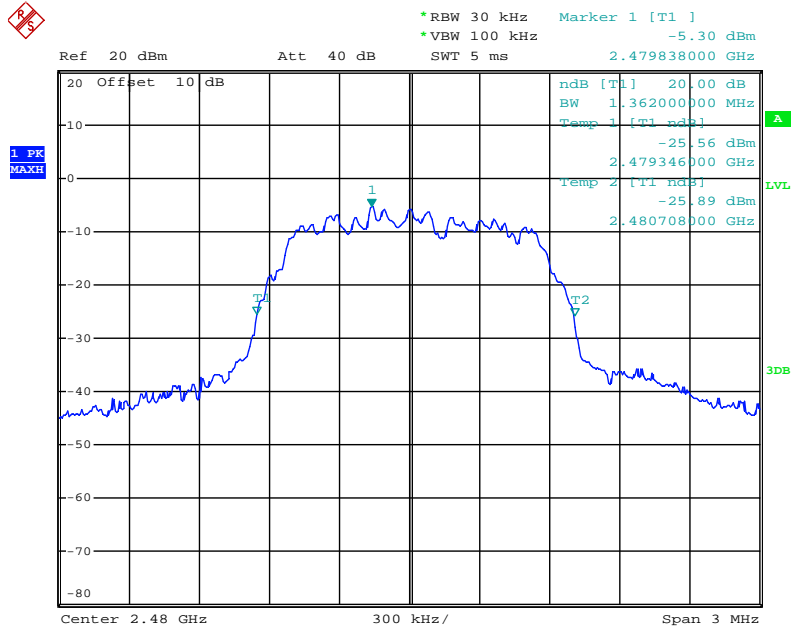

8DPSK Mode

Low channel

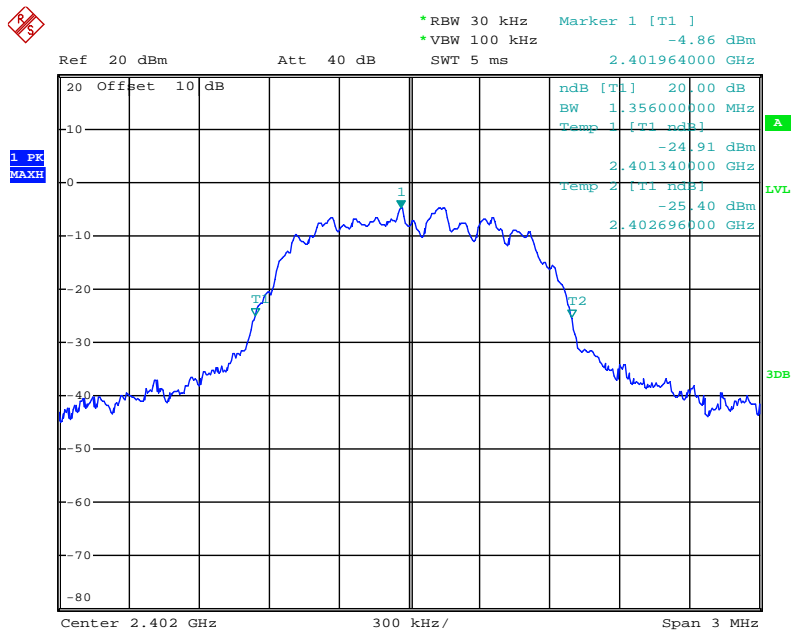

Middle channel

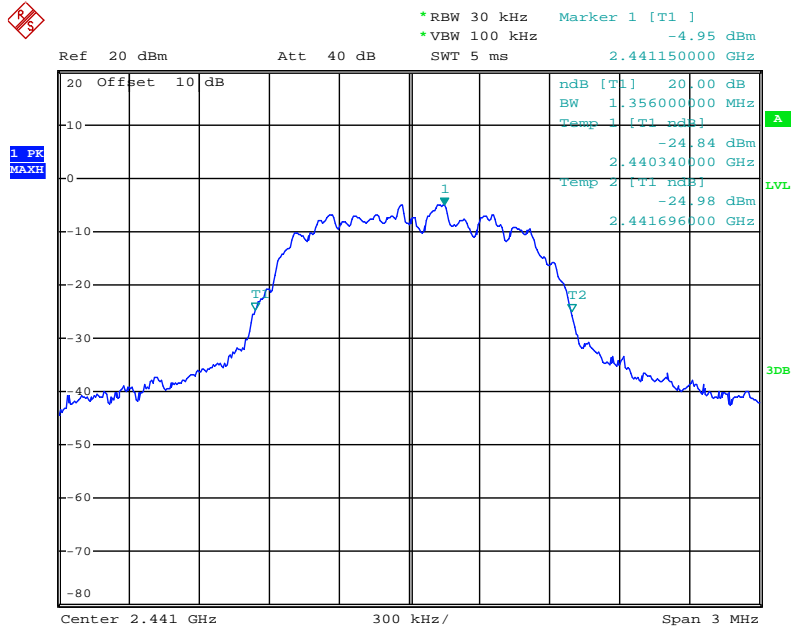

High channel

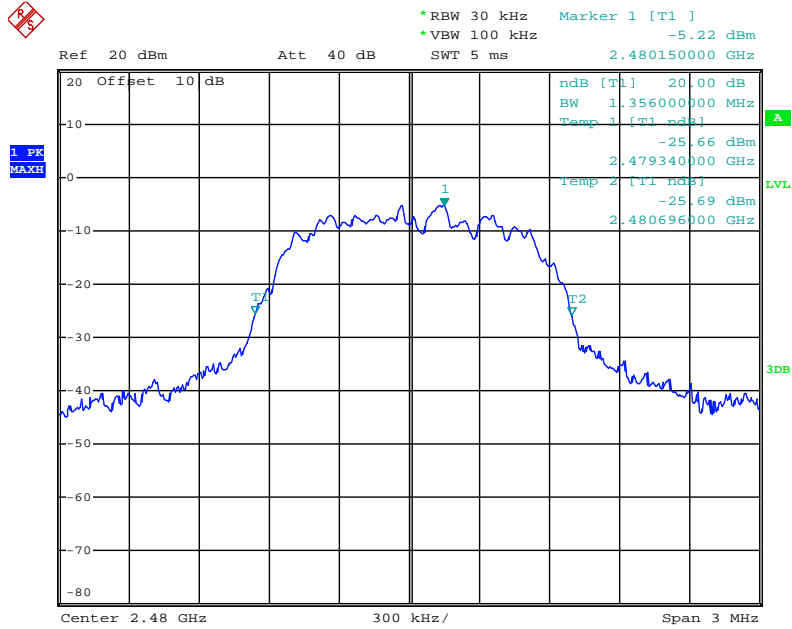

7. CARRIER FREQUENCY SEPARATION TEST

7.1. Block Diagram of Test Setup

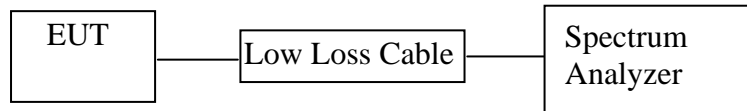

7.2. The Requirement For Section 15.247(a)(1)

Section 15.247(a)(1): Frequency hopping systems shall have hopping channel carrier frequencies separated by a minimum of 25 kHz or the 20 dB bandwidth of the hopping channel, whichever is greater. Alternatively, frequency hopping systems operating in the 2400-2483.5 MHz band may have hopping channel carrier frequencies that are separated by 25 kHz or two-thirds of the 20 dB bandwidth of the hopping channel, whichever is greater, provided the systems operate with an output power no greater than 125 mW. The system shall hop to channel frequencies that are selected at the system hopping rate from a pseudo randomly ordered list of hopping frequencies. Each frequency must be used equally on the average by each transmitter. The system receivers shall have input bandwidths that match the hopping channel bandwidths of their corresponding transmitters and shall shift frequencies in synchronization with the transmitted signals.

7.3. EUT Configuration on Measurement

The equipment are installed on the emission measurement to meet the commission requirements and operating regulations in a manner which tends to maximize its emission characteristics in normal application.

7.4. Operating Condition of EUT

7.4.1. Setup the EUT and simulator as shown as Section 6.1.

7.4.2. Turn on the power of all equipment.

7.4.3. Let the EUT work in TX (Hopping on) modes measure it. The transmit frequency are 2402-2480MHz. We select 2402MHz, 2441MHz, and 2480MHz TX frequency to transmit.

7.5. Test Procedure

7.5.1. The transmitter output was connected to the spectrum analyzer through a low loss cable.

7.5.2. Set RBW of spectrum analyzer to 30 kHz and VBW to 100 kHz. Adjust Span to 3 MHz.

7.5.3. Set the adjacent channel of the EUT Maxhold another trace.

7.5.4. Measurement the channel separation

7.6. Test Result

GFSK

Channel	Frequency (MHz)	Channel Separation(MHz)	Limit (MHz)	Result
Low	2402	1.002	25KHz or 2/3*20dB bandwidth	Pass
	2403			
Middle	2440	1.002	25KHz or 2/3*20dB bandwidth	Pass
	2441			
High	2479	1.008	25KHz or 2/3*20dB bandwidth	Pass
	2480			

Π/4-DQPSK

Channel	Frequency (MHz)	Channel Separation(MHz)	Limit (MHz)	Result
Low	2402	1.002	25KHz or 2/3*20dB bandwidth	Pass
	2403			
Middle	2440	1.002	25KHz or 2/3*20dB bandwidth	Pass
	2441			
High	2479	1.008	25KHz or 2/3*20dB bandwidth	Pass
	2480			

8DPSK

Channel	Frequency (MHz)	Channel Separation(MHz)	Limit (MHz)	Result
Low	2402	1.008	25KHz or 2/3*20dB bandwidth	Pass
	2403			
Middle	2440	1.020	25KHz or 2/3*20dB bandwidth	Pass
	2441			
High	2479	1.002	25KHz or 2/3*20dB bandwidth	Pass
	2480			

GFSK Mode

Low channel

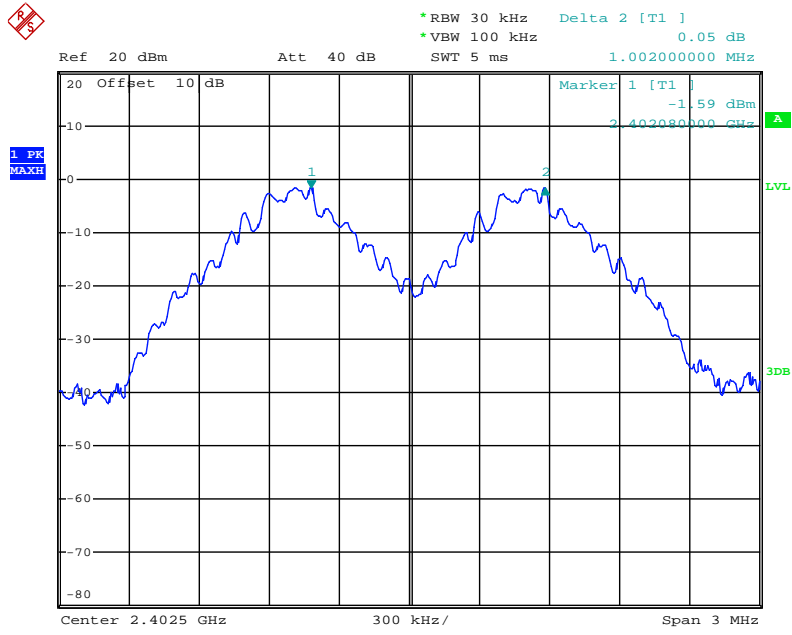

Middle channel

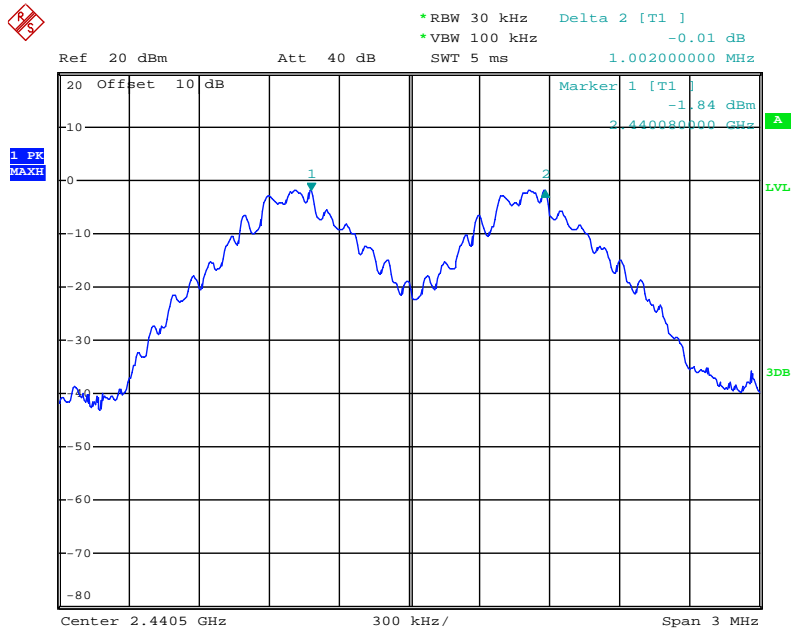

High channel

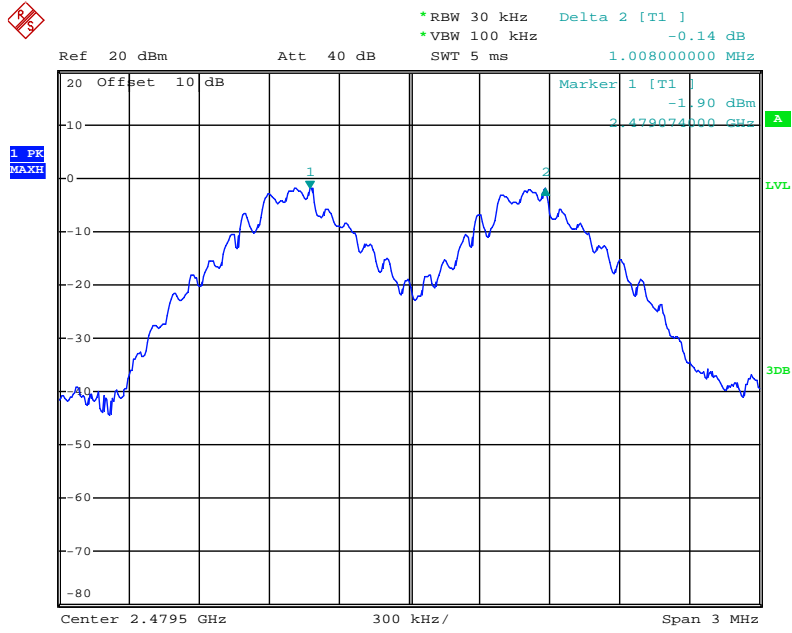

Π/4-DQPSK Mode

Low channel

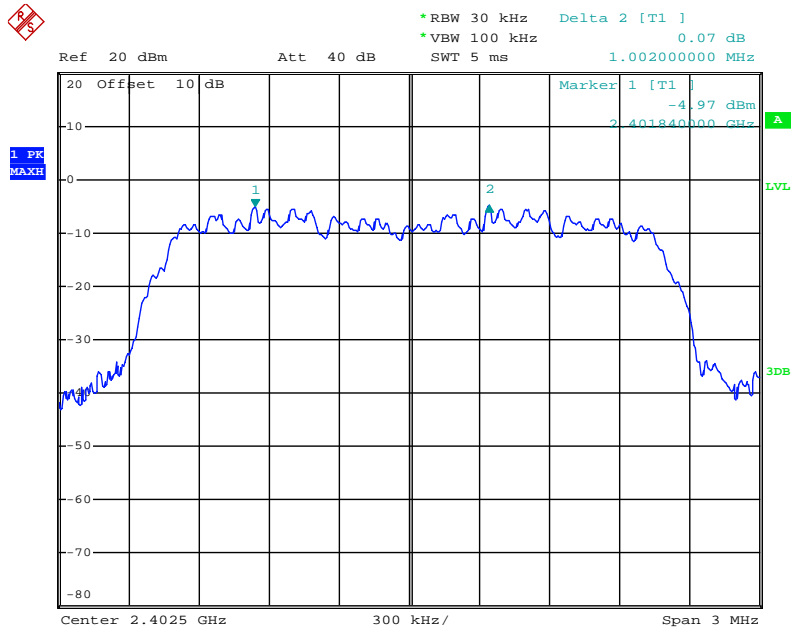

Middle channel

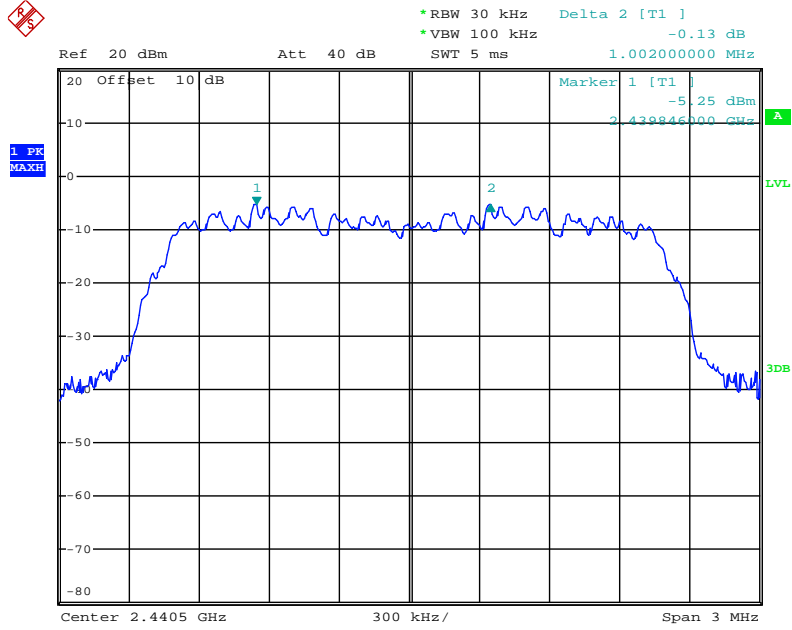

High channel

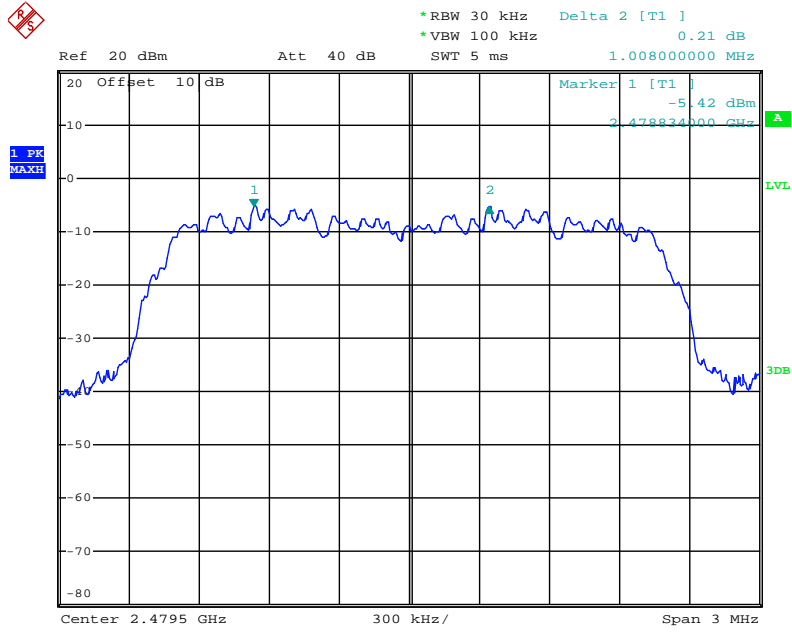

8DPSK Mode

Low channel

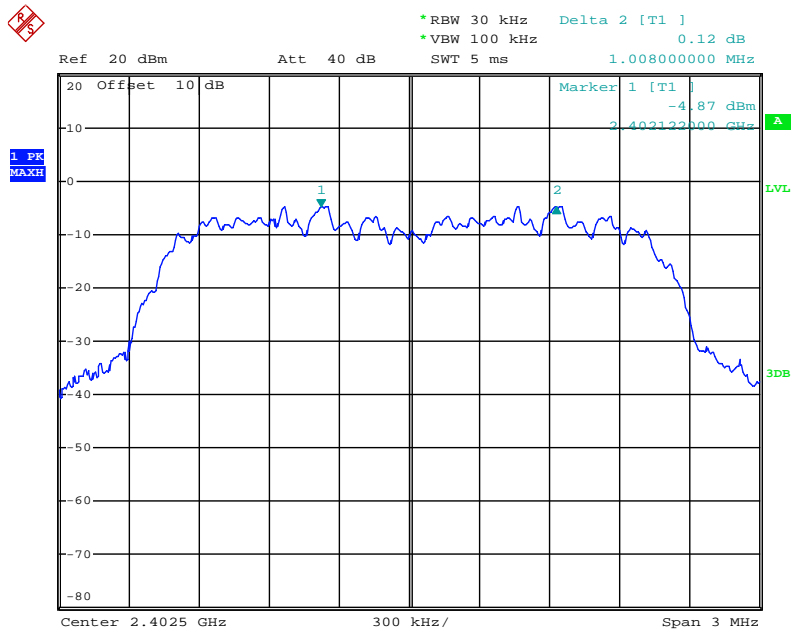

Middle channel

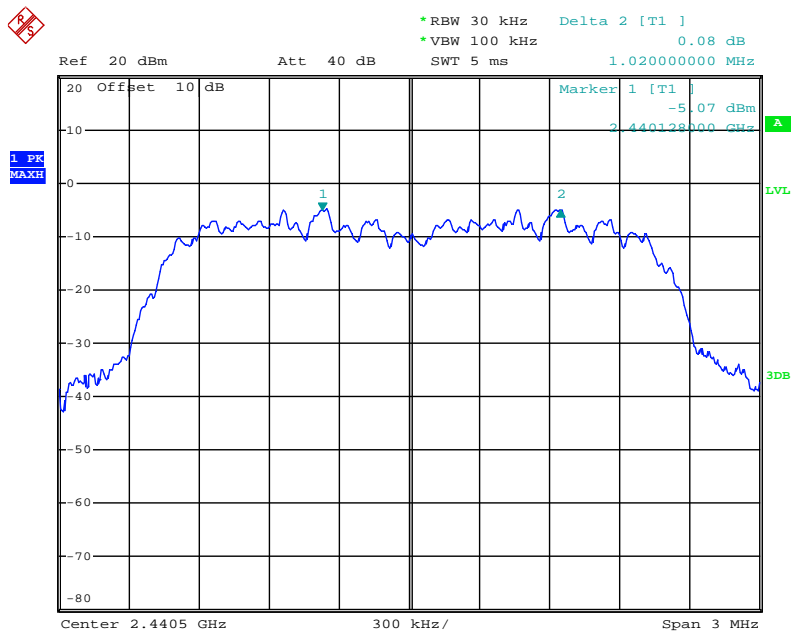

High channel

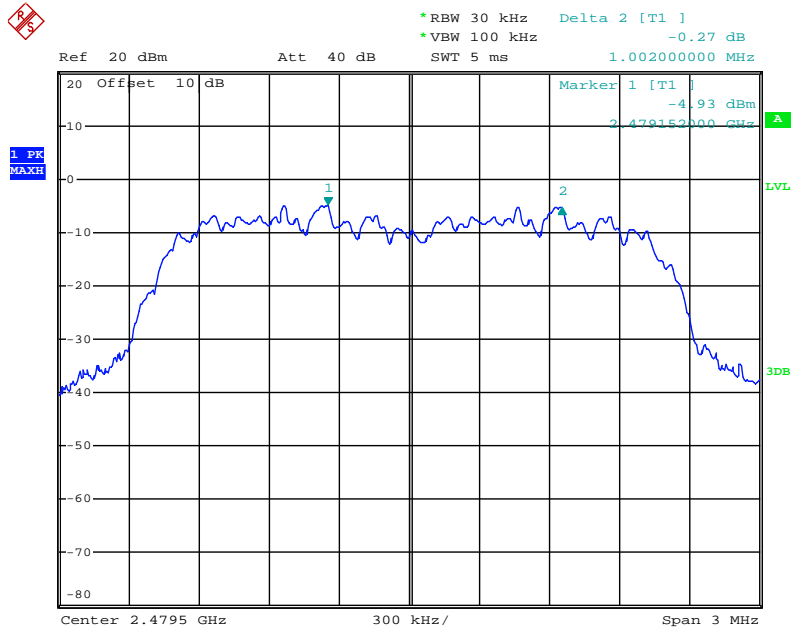

8. NUMBER OF HOPPING FREQUENCY TEST

8.1. Block Diagram of Test Setup

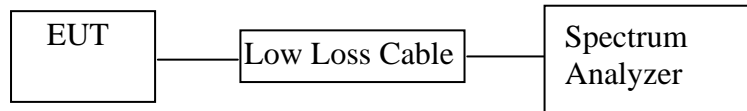

8.2. The Requirement For Section 15.247(a)(1)(iii)

Section 15.247(a)(1)(iii): Frequency hopping systems in the 2400-2483.5 MHz band shall use at least 15 channels.

8.3. EUT Configuration on Measurement

The equipment are installed on the emission measurement to meet the commission requirements and operating regulations in a manner which tends to maximize its emission characteristics in normal application.

8.4. Operating Condition of EUT

8.4.1. Setup the EUT and simulator as shown as Section 7.1.

8.4.2. Turn on the power of all equipment.

8.4.3. Let the EUT work in TX (Hopping on) modes measure it.

8.5. Test Procedure

8.5.1. The transmitter output was connected to the spectrum analyzer through a low loss cable.

8.5.2. Set the spectrum analyzer as RBW=100 kHz, VBW=300 kHz.

8.5.3. Max hold, view and count how many channel in the band.

8.6. Test Result

Total number of hopping channel	Measurement result(CH)	Limit(CH)	Result
	79	≥ 15	Pass

The spectrum analyzer plots are attached as below.

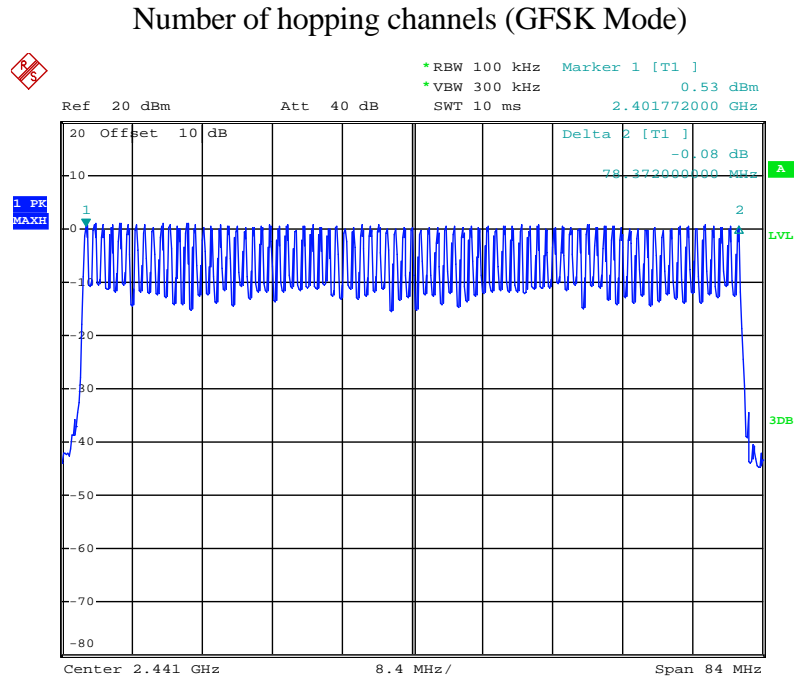

Number of hopping channels ($\Pi/4$ -DQPSK Mode)

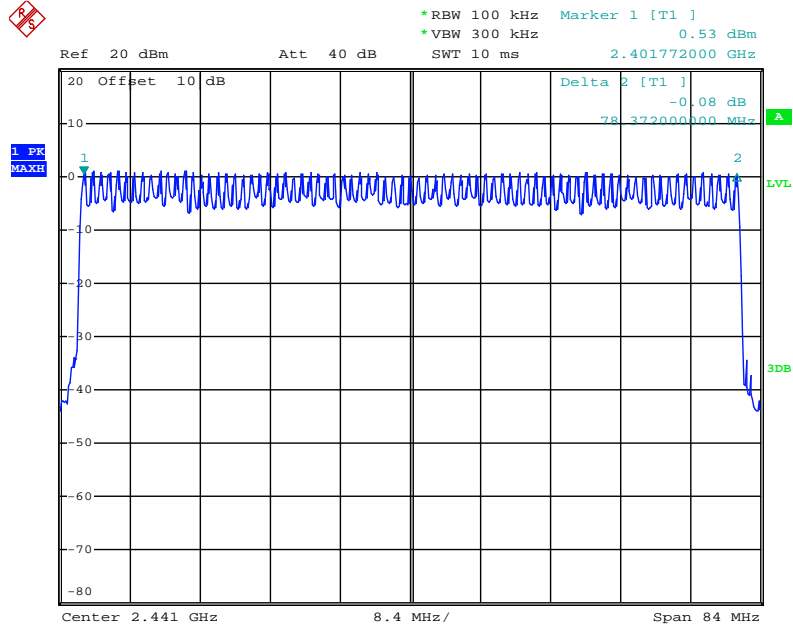

Number of hopping channels (8DPSK Mode)

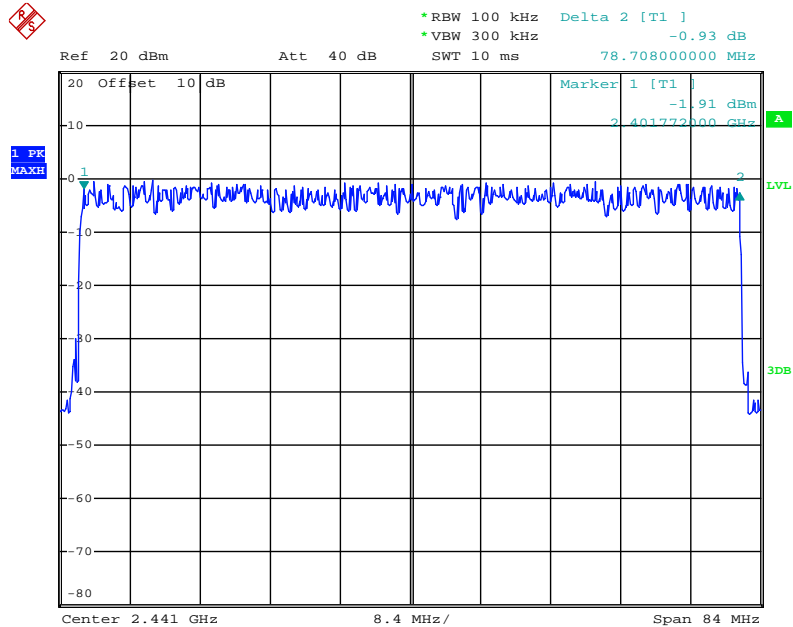

9. DWELL TIME TEST

9.1. Block Diagram of Test Setup

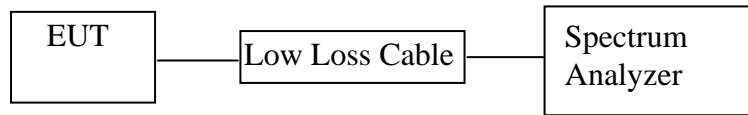

9.2. The Requirement For Section 15.247(a)(1)(iii)

Section 15.247(a)(1)(iii): Frequency hopping systems in the 2400-2483.5 MHz band shall use at least 15 channels. The average time of occupancy on any channel shall not be greater than 0.4 seconds within a period of 0.4 seconds multiplied by the number of hopping channels employed. Frequency hopping systems may avoid or suppress transmissions on a particular hopping frequency provided that a minimum of 15 channels are used.

9.3. EUT Configuration on Measurement

The equipment are installed on the emission measurement to meet the commission requirements and operating regulations in a manner which tends to maximize its emission characteristics in normal application.

9.4. Operating Condition of EUT

9.4.1. Setup the EUT and simulator as shown as Section 8.1.

9.4.2. Turn on the power of all equipment.

9.4.3. Let the EUT work in TX (Hopping on) modes measure it. The transmit frequency are 2402-2480MHz. We select 2402MHz, 2441MHz, and 2480MHz TX frequency to transmit.

9.5. Test Procedure

9.5.1. The transmitter output was connected to the spectrum analyzer through a low loss cable.

9.5.2. Set center frequency of spectrum analyzer = operating frequency.

9.5.3. Set the spectrum analyzer as RBW=1MHz, VBW=3MHz, Span=0Hz, Adjust Sweep=5ms, 10ms, 15ms. Get the pulse time.

9.5.4. Repeat above procedures until all frequency measured were complete.

9.6. Test Result

GFSK Mode (Worse case)

Mode	Channel Frequency (MHz)	Pulse Time (ms)	Dwell Time (ms)	Limit (ms)
DH1	2441	0.42	134.4	400
A period transmit time = $0.4 \times 79 = 31.6$ Dwell time = pulse time $\times (1600/(2*79)) \times 31.6$				
DH3	2441	1.68	268.8	400
A period transmit time = $0.4 \times 79 = 31.6$ Dwell time = pulse time $\times (1600/(4*79)) \times 31.6$				
DH5	2441	3.00	320.0	400
A period transmit time = $0.4 \times 79 = 31.6$ Dwell time = pulse time $\times (1600/(6*79)) \times 31.6$				

$\Pi/4$ -DQPSK (Worse case)

Mode	Channel Frequency (MHz)	Pulse Time (ms)	Dwell Time (ms)	Limit (ms)
DH1	2441	0.42	134.4	400
A period transmit time = $0.4 \times 79 = 31.6$ Dwell time = pulse time $\times (1600/(2*79)) \times 31.6$				
DH3	2441	1.72	275.2	400
A period transmit time = $0.4 \times 79 = 31.6$ Dwell time = pulse time $\times (1600/(4*79)) \times 31.6$				
DH5	2441	3.00	320.0	400
A period transmit time = $0.4 \times 79 = 31.6$ Dwell time = pulse time $\times (1600/(6*79)) \times 31.6$				

8DPSK Mode (Worse case)

Mode	Channel Frequency (MHz)	Pulse Time (ms)	Dwell Time (ms)	Limit (ms)
DH1	2441	0.40	128.0	400
A period transmit time = $0.4 \times 79 = 31.6$ Dwell time = pulse time $\times (1600/(2*79)) \times 31.6$				
DH3	2441	1.68	268.8	400
A period transmit time = $0.4 \times 79 = 31.6$ Dwell time = pulse time $\times (1600/(4*79)) \times 31.6$				
DH5	2441	3.00	320.0	400
A period transmit time = $0.4 \times 79 = 31.6$ Dwell time = pulse time $\times (1600/(6*79)) \times 31.6$				

Note: We tested GFSK mode and $\Pi/4$ -DQPSK & 8DPSK mode the low, middle and high channel and recorded the Worse case data for all test mode.

The spectrum analyzer plots are attached as below.

GFSK Mode

DH1 Middle channel

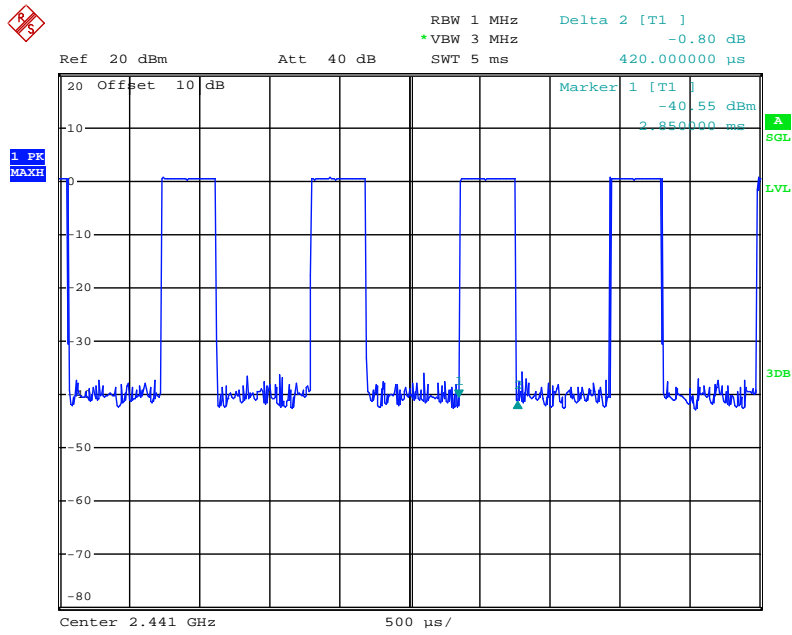

DH3 Middle channel

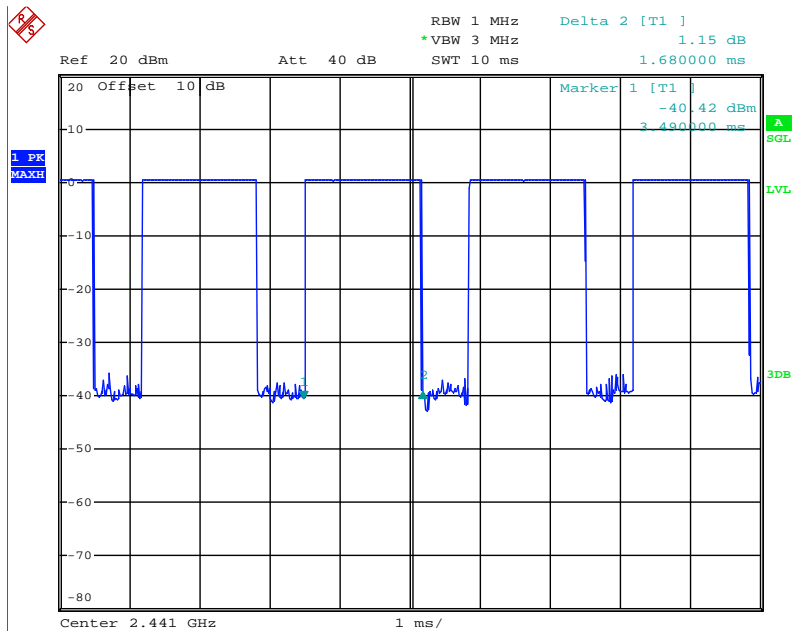

DH5 Middle channel

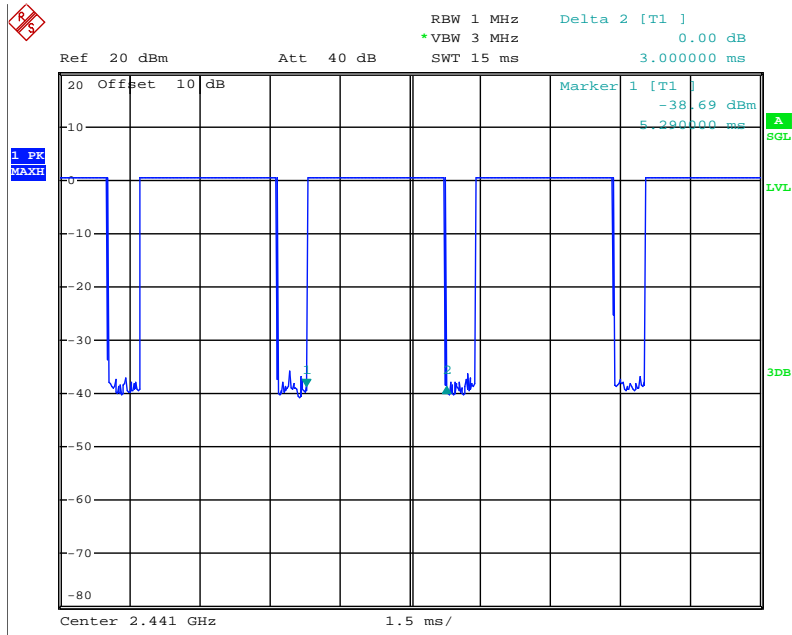

$\Pi/4$ -DQPSK Mode

2DH1 Middle channel

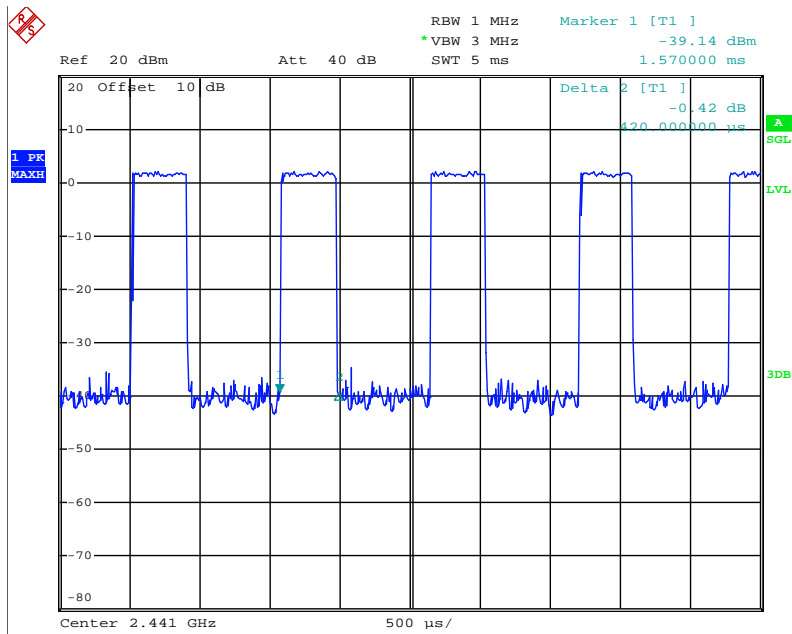

2DH3 Middle channel

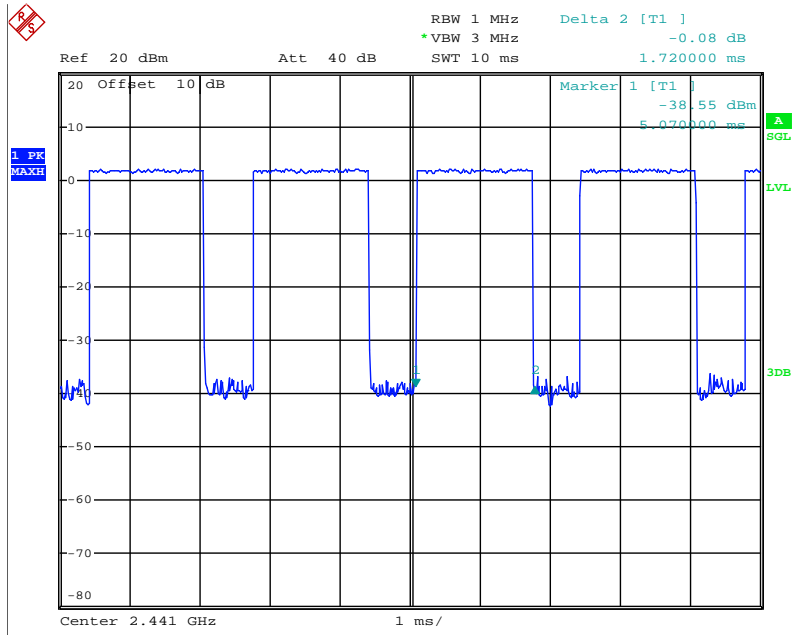

2DH5 Middle channel

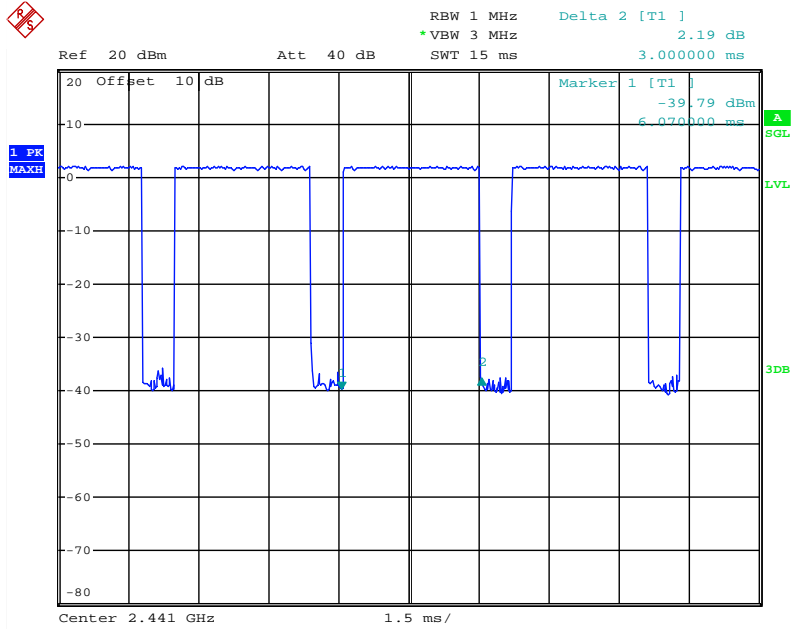

8DPSK Mode

3DH1 Middle channel

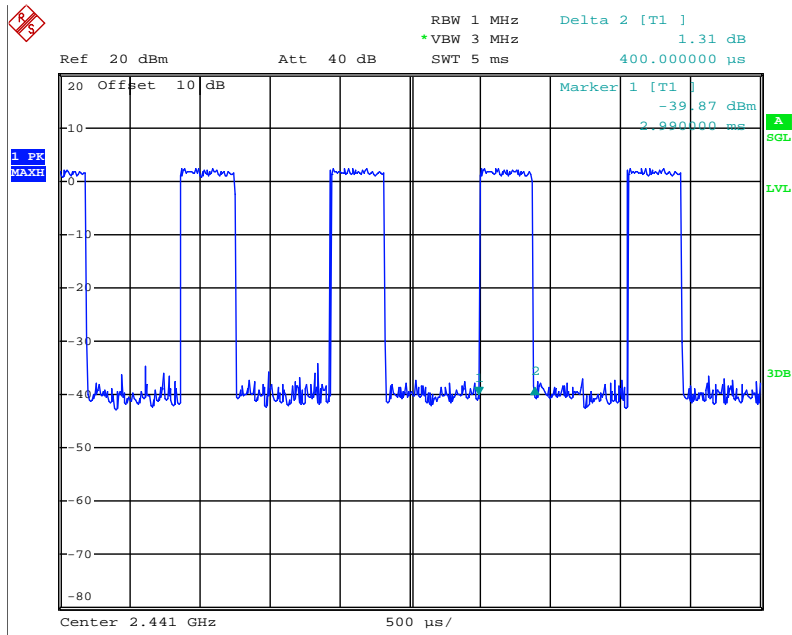

3DH3 Middle channel

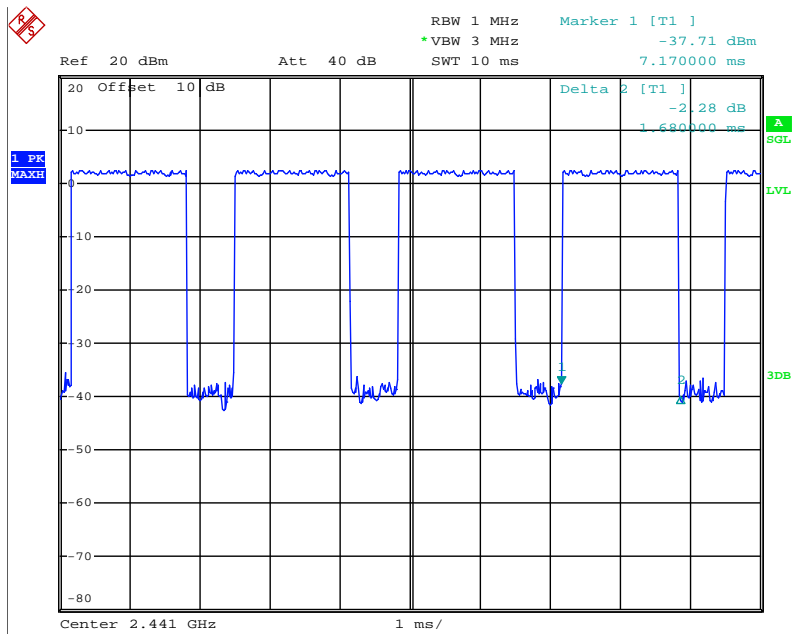

3DH5 Middle channel

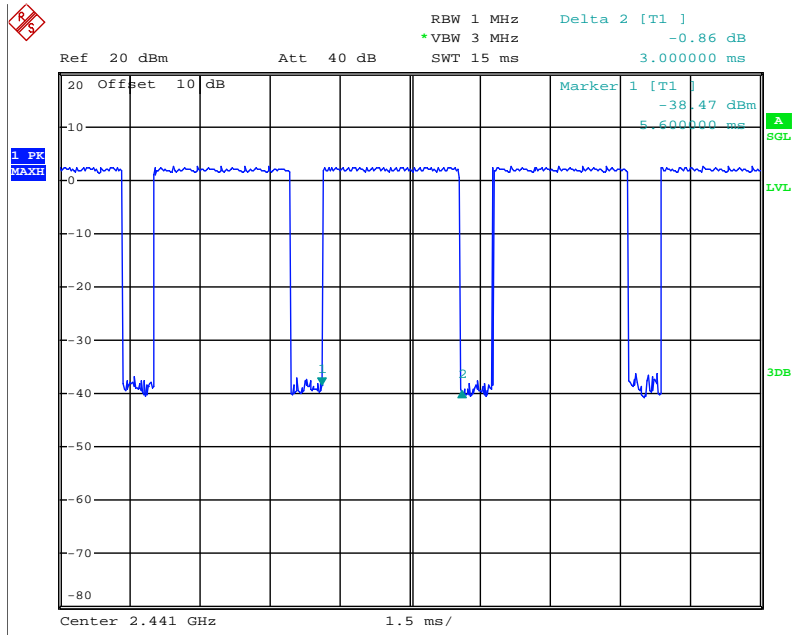

10. MAXIMUM PEAK OUTPUT POWER TEST

10.1. Block Diagram of Test Setup

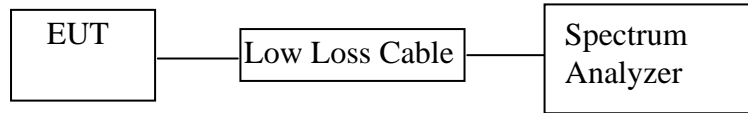

10.2. The Requirement For Section 15.247(b)(1)

Section 15.247(b)(1): For frequency hopping systems operating in the 2400-2483.5 MHz band employing at least 75 non-overlapping hopping channels, and all frequency hopping systems in the 5725-5850 MHz band: 1 watt. For all other frequency hopping systems in the 2400-2483.5 MHz band: 0.125 watts.

10.3. EUT Configuration on Measurement

The equipment are installed on the emission Measurement to meet the commission requirements and operating regulations in a manner which tends to maximize its emission characteristics in normal application.

10.4. Operating Condition of EUT

10.4.1. Setup the EUT and simulator as shown as Section 9.1.

10.4.2. Turn on the power of all equipment.

10.4.3. Let the EUT work in TX (Hopping off) modes measure it. The transmit frequency are 2402-2480MHz. We select 2402MHz, 2441MHz, and 2480MHz TX frequency to transmit.

10.5. Test Procedure

10.5.1. The transmitter output was connected to the spectrum analyzer through a low loss cable.

10.5.2. Set RBW of spectrum analyzer to 3MHz and VBW to 10MHz.

10.5.3. Measurement the maximum peak output power.

10.6. Test Result

GFSK Mode

Channel	Frequency (MHz)	Peak Output Power (dBm/W)	Limits dBm / W
Low	2402	0.91/0.0012	21 / 0.125
Middle	2441	0.69/0.0012	21 / 0.125
High	2480	0.45/0.0011	21 / 0.125

Π/4-DQPSK Mode

Channel	Frequency (MHz)	Peak Output Power (dBm/W)	Limits dBm / W
Low	2402	3.09/0.0020	21 / 0.125
Middle	2441	2.84/0.0019	21 / 0.125
High	2480	2.75/0.0019	21 / 0.125

8DPSK Mode

Channel	Frequency (MHz)	Peak Output Power (dBm/W)	Limits dBm / W
Low	2402	3.55/0.0023	21 / 0.125
Middle	2441	3.39/0.0022	21 / 0.125
High	2480	3.00/0.0020	21 / 0.125

The spectrum analyzer plots are attached as below.

GFSK Mode

Low channel

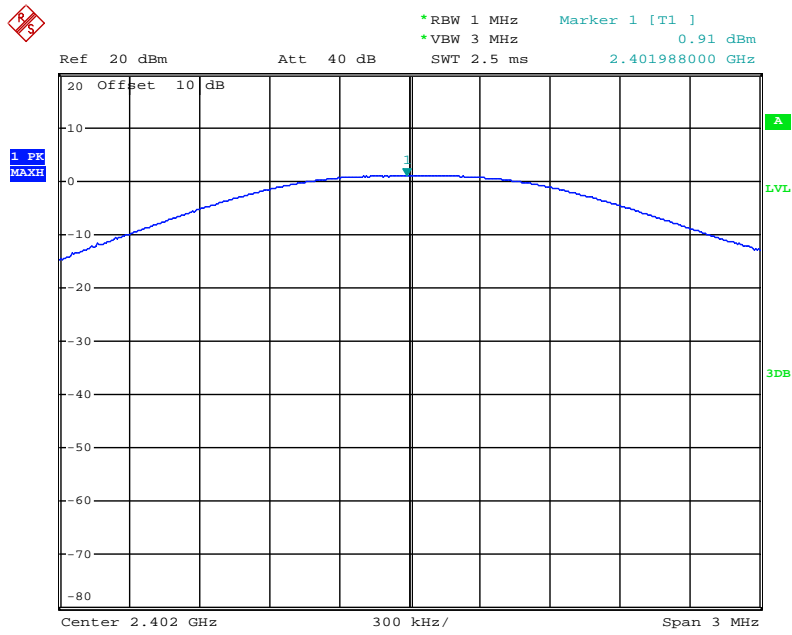

Middle channel

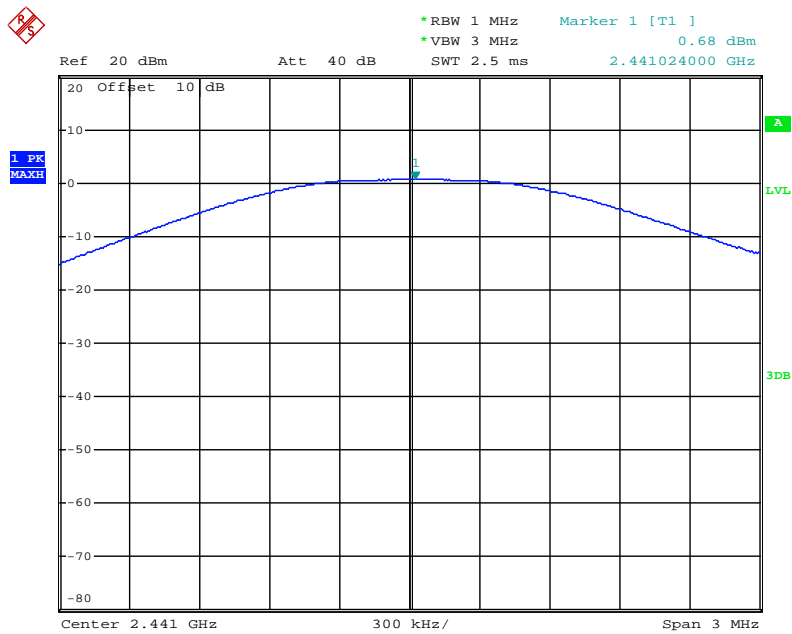

High channel

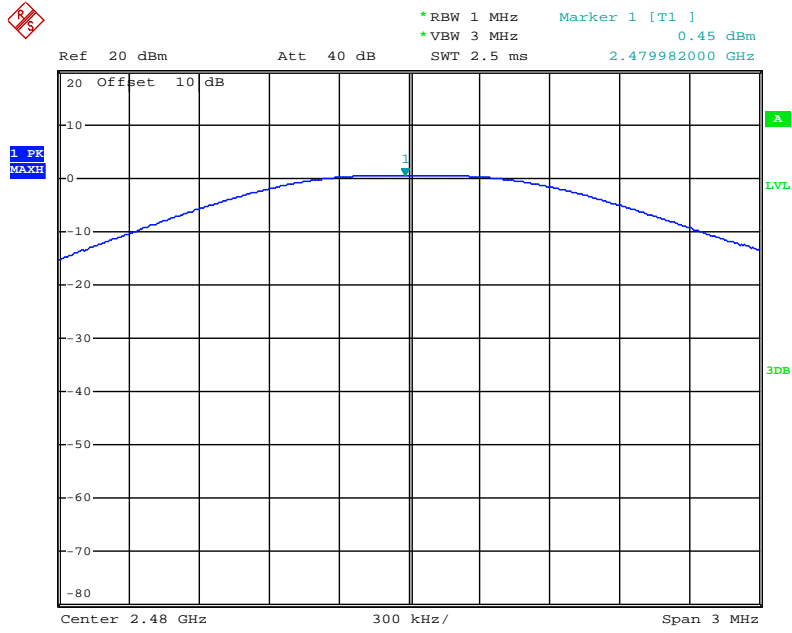

Π/4-DQPSK Mode

Low channel

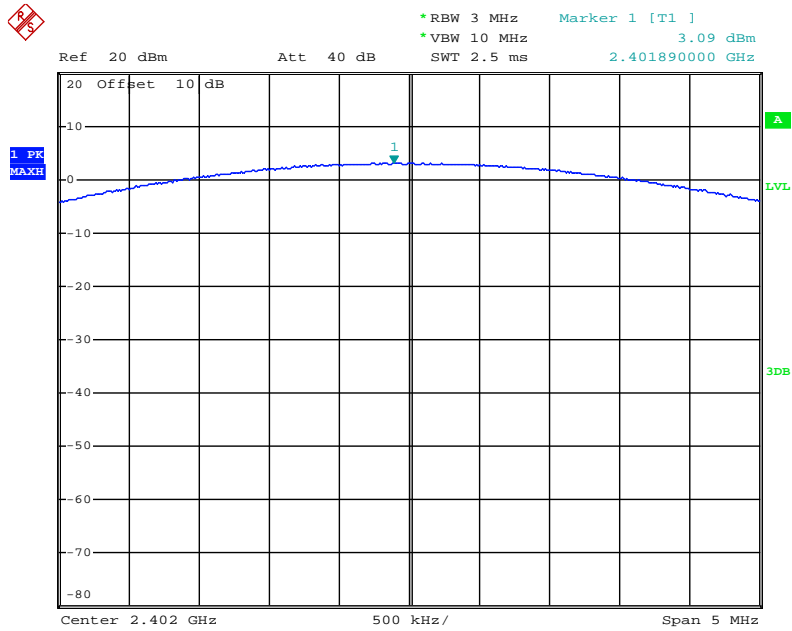

Middle channel

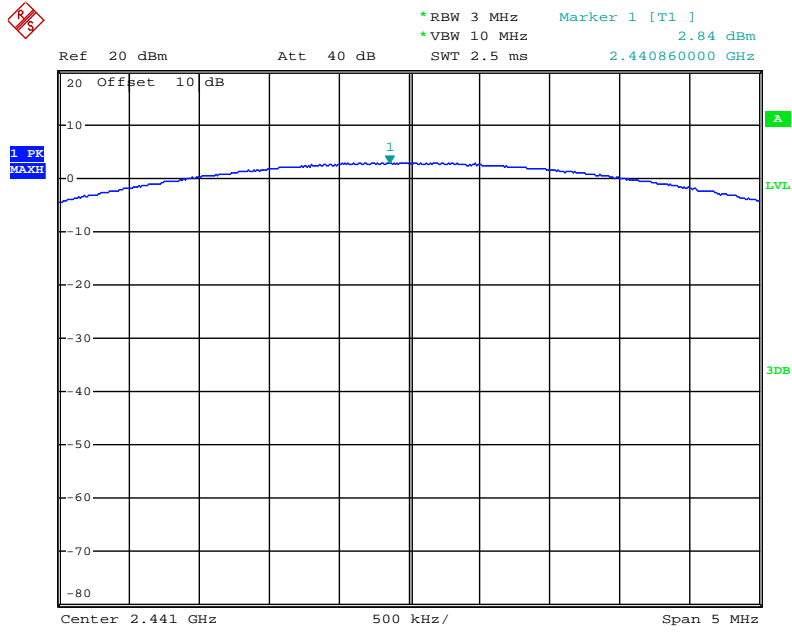

High channel

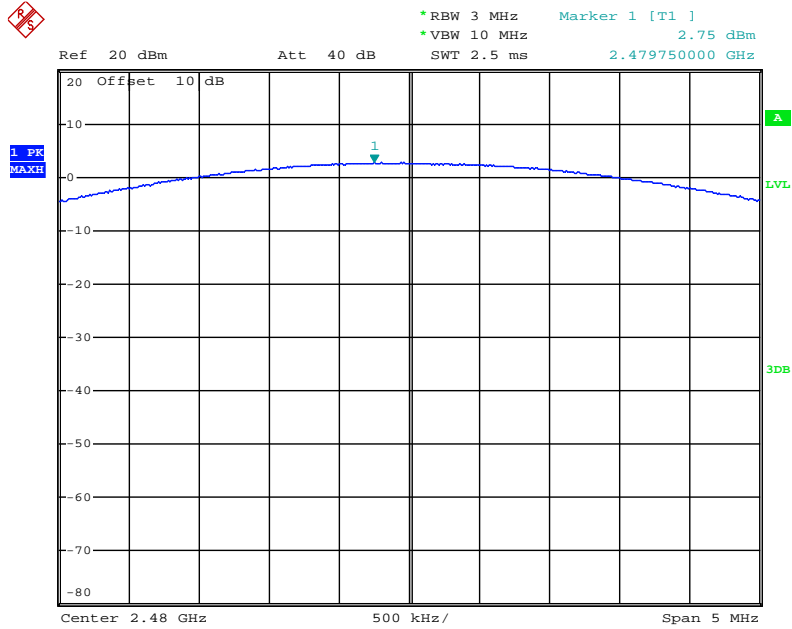

8DPSK Mode

Low channel

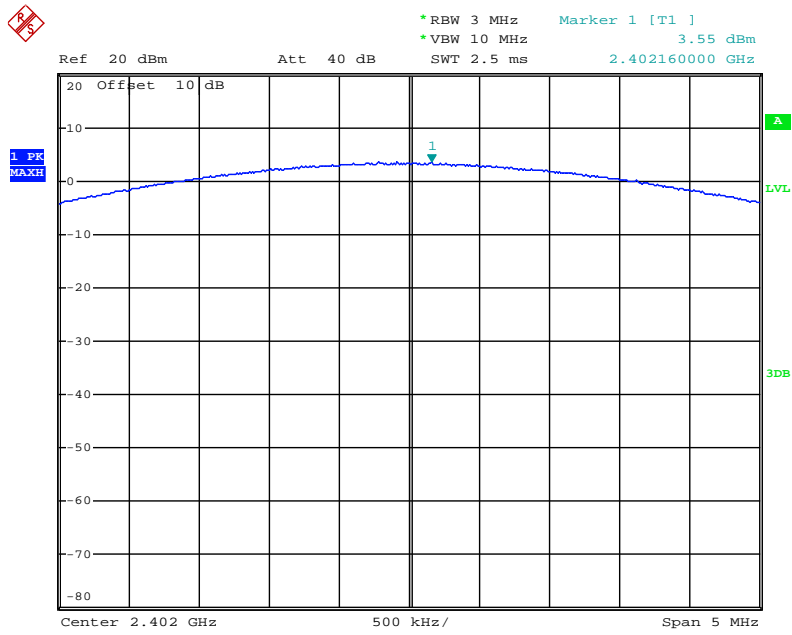

Middle channel

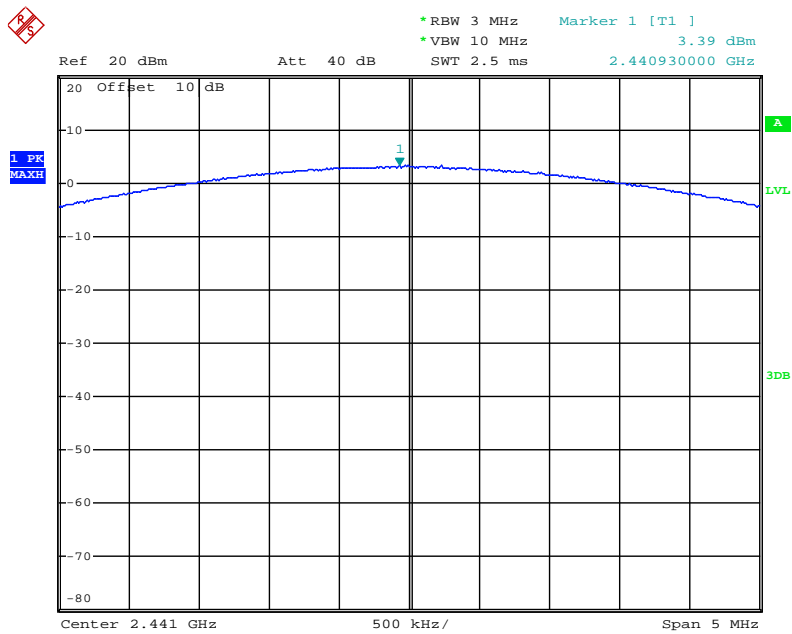

High channel

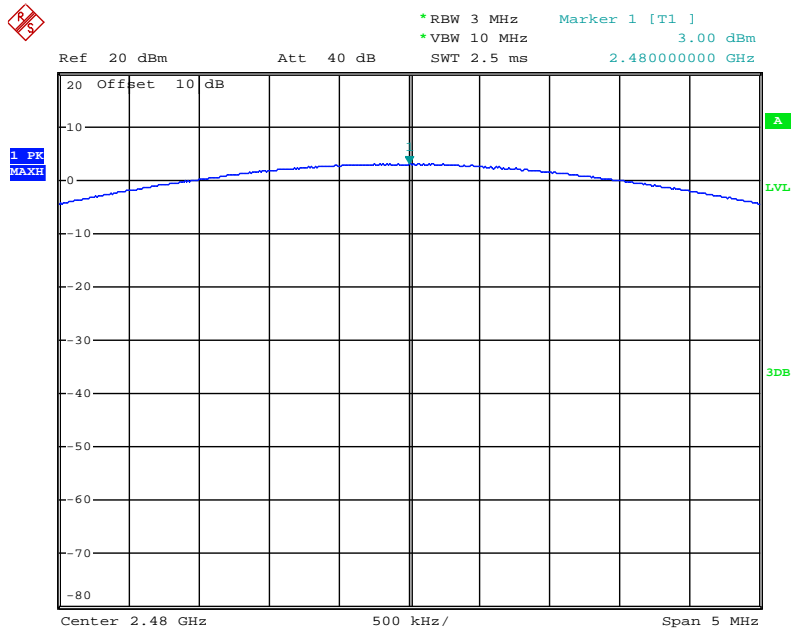

11. RADIATED EMISSION TEST

11.1. Block Diagram of Test Setup

11.1.1. Block diagram of connection between the EUT and peripherals

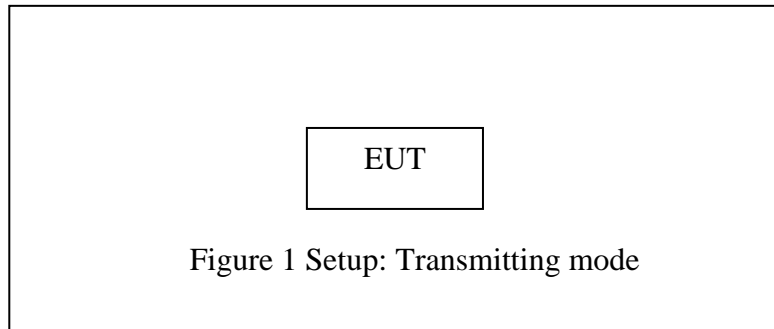

11.1.2. Semi-Anechoic Chamber Test Setup Diagram

(A) Radiated Emission Test Set-Up, Frequency below 30MHz

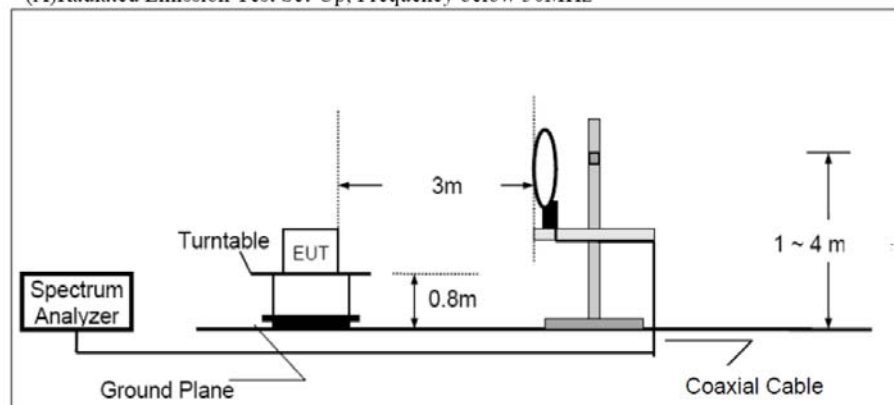

(B) Radiated Emission Test Set-Up, Frequency 30MHz-1GHz

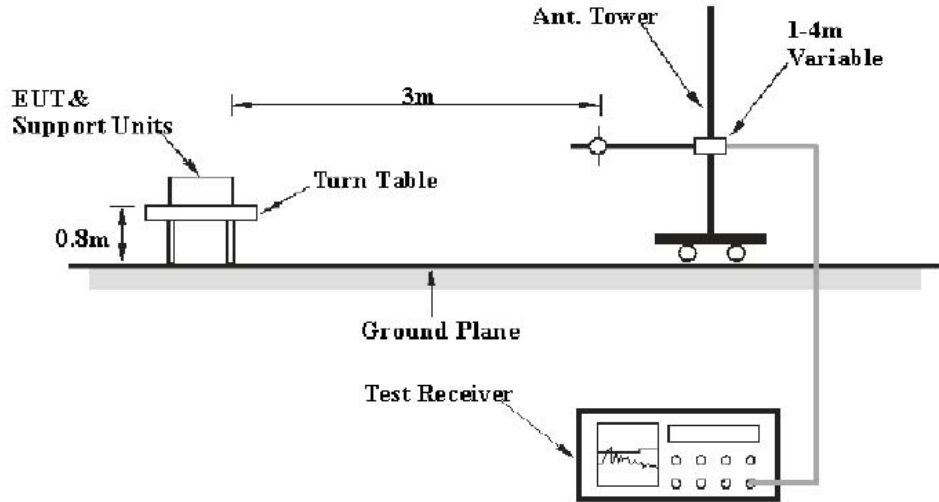

(C) Radiated Emission Test Set-Up, Frequency above 1GHz

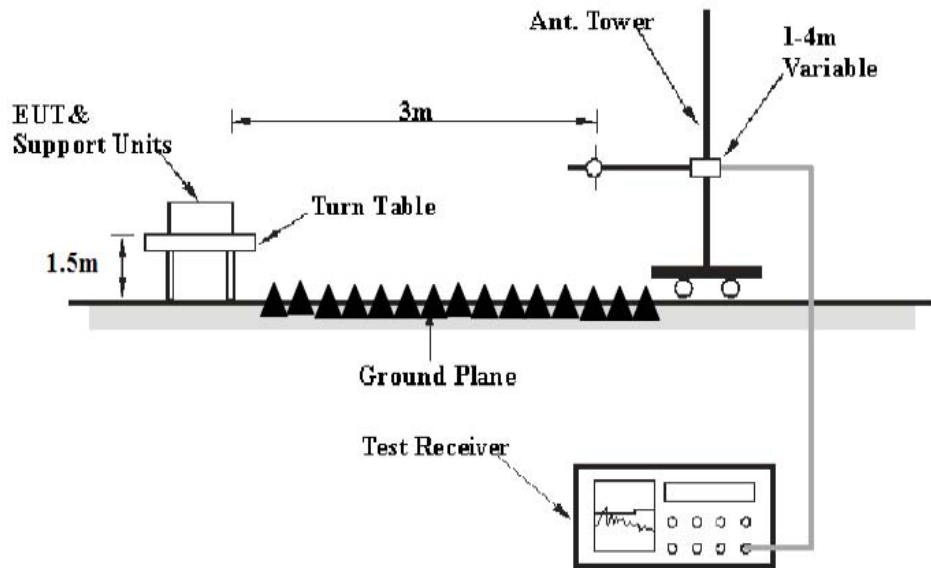

11.2. The Limit For Section 15.247(d)

Section 15.247(d): In any 100 kHz bandwidth outside the frequency band in which the spread spectrum or digitally modulated intentional radiator is operating, the radio frequency power that is produced by the intentional radiator shall be at least 20 dB below that in the 100 kHz bandwidth within the band that contains the highest level of the desired power, based on either an RF conducted or a radiated measurement, provided the transmitter demonstrates compliance with the peak conducted power limits. If the transmitter complies with the conducted power limits based on the use of RMS averaging over a time interval, as permitted under paragraph (b)(3) of this section, the attenuation required under this paragraph shall be 30 dB instead of 20 dB. Attenuation below the

general limits specified in Section 15.209(a) is not required. In addition, radiated emissions which fall in the restricted bands, as defined in Section 15.205(a), must also comply with the radiated emission limits specified in Section 15.209(a).

11.3.Restricted bands of operation

11.3.1.FCC Part 15.205 Restricted bands of operation

(a) Except as shown in paragraph (d) of this section, Only spurious emissions are permitted in any of the frequency bands listed below:

MHz	MHz	MHz	GHz
0.090-0.110	16.42-16.423	399.9-410	4.5-5.15
¹ 0.495-0.505	16.69475-16.69525	608-614	5.35-5.46
2.1735-2.1905	16.80425-16.80475	960-1240	7.25-7.75
4.125-4.128	25.5-25.67	1300-1427	8.025-8.5
4.17725-4.17775	37.5-38.25	1435-1626.5	9.0-9.2
4.20725-4.20775	73-74.6	1645.5-1646.5	9.3-9.5
6.215-6.218	74.8-75.2	1660-1710	10.6-12.7
6.26775-6.26825	108-121.94	1718.8-1722.2	13.25-13.4
6.31175-6.31225	123-138	2200-2300	14.47-14.5
8.291-8.294	149.9-150.05	2310-2390	15.35-16.2
8.362-8.366	156.52475-156.52525	2483.5-2500	17.7-21.4
8.37625-8.38675	156.7-156.9	2690-2900	22.01-23.12
8.41425-8.41475	162.0125-167.17	3260-3267	23.6-24.0
12.29-12.293	167.72-173.2	3332-3339	31.2-31.8
12.51975-12.52025	240-285	3345.8-3358	36.43-36.5
12.57675-12.57725	322-335.4	3600-4400	(²)
13.36-13.41			

¹Until February 1, 1999, this restricted band shall be 0.490-0.510

²Above 38.6

(b) Except as provided in paragraphs (d) and (e), the field strength of emission appearing within these frequency bands shall not exceed the limits shown in Section 15.209. At frequencies equal to or less than 1000MHz, Compliance with the limits in Section 15.209 shall be demonstrated using measurement instrumentation employing a CISPR quasi-peak detector. Above 1000MHz, compliance with the emission limits in Section 15.209 shall be demonstrated based on the average value of the measured emissions. The provisions in Section 15.35 apply to these measurements.

11.4.Configuration of EUT on Measurement

The equipment is installed on Radiated Emission Measurement to meet the commission requirements and operating regulations in a manner which tends to maximize its emission characteristics in normal application.

11.5. Operating Condition of EUT

11.5.1. Setup the EUT and simulator as shown as Section 10.1.

11.5.2. Turn on the power of all equipment.

11.5.3. Let the EUT work in TX modes measure it. The transmit frequency are 2402-2480MHz. We select 2402MHz, 2441MHz, and 2480MHz TX frequency to transmit.

11.6. Test Procedure

The EUT and its simulators are placed on a turntable, which is 0.8 meter high above ground (Below 1GHz). The EUT and its simulators are placed on a turntable, which is 1.5 meter high above ground (Above 1GHz). The turntable can rotate 360 degrees to determine the position of the maximum emission level. EUT is set 3.0 meters away from the receiving antenna, which is mounted on an antenna tower. The antenna can be moved up and down between 1.0 meter and 4 meters to find out the maximum emission level. Broadband antenna (calibrated bi-log antenna) is used as receiving antenna. Both horizontal and vertical polarizations of the antenna are set on measurement. In order to find the maximum emission levels, all of the EUT location must be manipulated according to ANSI C63.10:2013 on radiated emission measurement. This EUT was tested in 3 orthogonal positions and the Worst case position data was reported.

During the radiated emission test, the spectrum analyzer was set with the following configurations:

1. The resolution bandwidth and video bandwidth of test receiver/spectrum analyzer is 120kHz for Quasi-peak at frequency below 1GHz.
2. The resolution bandwidth of test receiver/spectrum analyzer is 1MHz and video bandwidth is 3MHz for peak measurement with peak detector at frequency above 1GHz.
3. The resolution bandwidth of test receiver/spectrum analyzer is 1MHz and video bandwidth is 10Hz for Average measurement with peak detection at frequency above 1GHz.
4. All modes of operation were investigated and the worst-case emissions are reported.

11.7.Data Sample

Frequency (MHz)	Reading (dB μ v)	Factor (dB/m)	Result (dB μ v/m)	Limit (dB μ v/m)	Margin (dB)	Remark
X.XX	28.66	-15.19	13.47	40.0	-26.53	QP

Frequency(MHz) = Emission frequency in MHz

Reading(dB μ v) = Uncorrected Analyzer/Receiver reading

Factor (dB/m) = Antenna factor + Cable Loss – Amplifier gain

Result(dB μ v/m) = Reading(dB μ v) + Factor(dB/m)

Limit (dB μ v/m) = Limit stated in standard

Margin (dB) = Result(dB μ v/m) - Limit (dB μ v/m)

QP = Quasi-peak Reading

Calculation Formula:

Margin(dB) = Result (dB μ V/m)–Limit(dB μ V/m)

Result(dB μ V/m)= Reading(dB μ V)+ Factor(dB/m)

The “Margin” column of the following data tables indicates the degree of compliance with the applicable limit. For example, a margin of -7dB means the emission is 7dB below the limit.

11.8.Tetst Results

Pass.

Test Lab: 3m Anechoic chamber

Note: 1.We tested GFSK mode, $\Pi/4$ -DQPSK Mode & 8DPSK mode and recorded the Worse case data (GFSK mode) for all test mode.

2. Testing is carried out with frequency rang 9kHz to the tenth harmonics, which above 3th Harmonics are attenuated more than 20dB below the permissible limits or the field strength is too small to be measured.

The measurements greater than 20dB below the limit from 9kHz to 30MHz and 18 to 26.5GHz.

The spectrum analyzer plots are attached as below.

Below 1GHz



ACCURATE TECHNOLOGY CO., LTD.

F1,Bldg,A,Changyuan New Material Port Keyuan Rd,
Science & Industry Park,Nanshan Shenzhen,P.R.China

Site: 1# Chamber
Tel:+86-0755-26503290
Fax:+86-0755-26503396

Job No.: FRANK2019-W #359
Standard: FCC Class B 3M Radiated
Test item: Radiation Test
Temp.(C)/Hum.(%) 25 C / 55 %
EUT: Bluetooth earphone
Mode: TX2402MHz
Model: BL1
Manufacturer: Dongguan Luxun Electronic Technology Co., Ltd

Polarization: Horizontal
Power Source: DC 3.7V
Date: 19/11/05/
Time: 17/16/05
Engineer Signature: CHARLEY
Distance: 3m

Note: Report NO.:ATE20191613

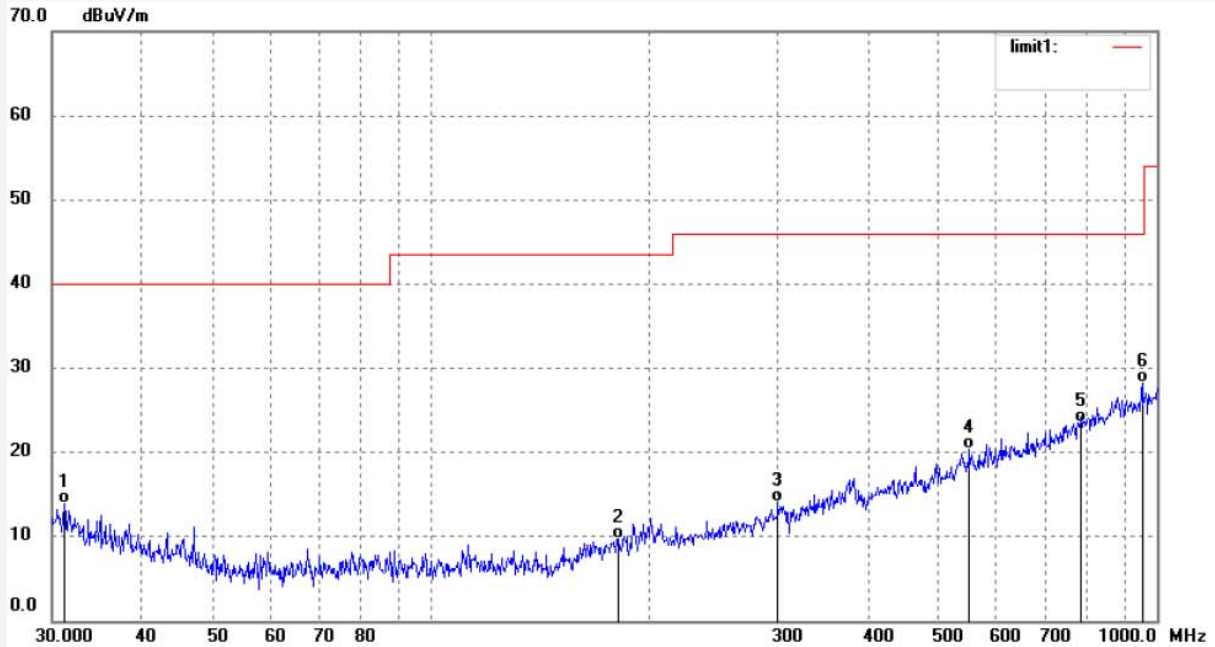

No.	Freq. (MHz)	Reading (dBuV/m)	Factor (dB)	Result (dBuV/m)	Limit (dBuV/m)	Margin (dB)	Detector	Height (cm)	Degree (deg.)	Remark
1	31.1822	34.43	-20.49	13.94	40.00	-26.06	QP	200	185	
2	180.6640	35.72	-25.97	9.75	43.50	-33.75	QP	200	321	
3	300.6988	35.34	-21.20	14.14	46.00	-31.86	QP	200	201	
4	552.2270	35.09	-14.75	20.34	46.00	-25.66	QP	200	82	
5	779.2178	33.15	-9.55	23.60	46.00	-22.40	QP	200	211	
6	955.3509	34.37	-6.18	28.19	46.00	-17.81	QP	200	79	



ACCURATE TECHNOLOGY CO., LTD.

F1,Bldg,A,Changyuan New Material Port Keyuan Rd,
Science & Industry Park,Nanshan Shenzhen,P.R.China

Site: 1# Chamber
Tel:+86-0755-26503290
Fax:+86-0755-26503396

Job No.: FRANK2019-W #360	Polarization: Vertical
Standard: FCC Class B 3M Radiated	Power Source: DC 3.7V
Test item: Radiation Test	Date: 19/11/05/
Temp.(C)/Hum.(%) 25 C / 55 %	Time: 17/18/25
EUT: Bluetooth earphone	Engineer Signature: CHARLEY
Mode: TX2402MHz	Distance: 3m
Model: BL1	
Manufacturer: Dongguan Luxun Electronic Technology Co., Ltd	

Note: Report NO.:ATE20191613

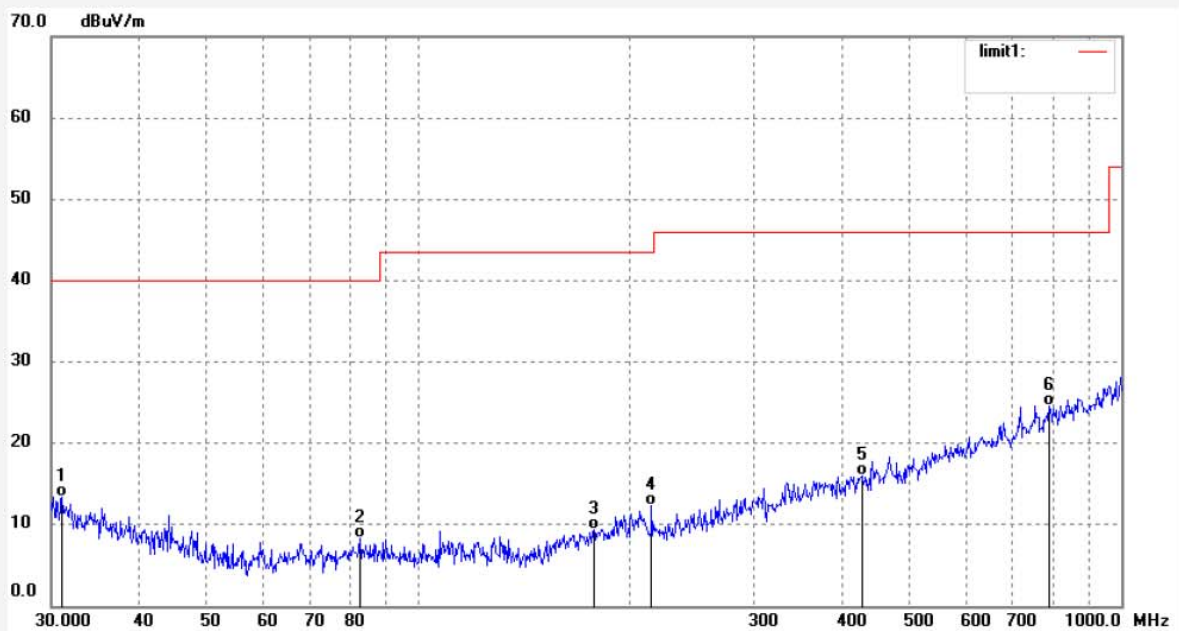

No.	Freq. (MHz)	Reading (dBuV/m)	Factor (dB)	Result (dBuV/m)	Limit (dBuV/m)	Margin (dB)	Detector	Height (cm)	Degree (deg.)	Remark
1	31.0728	33.92	-20.47	13.45	40.00	-26.55	QP	100	196	
2	82.5257	35.66	-27.43	8.23	40.00	-31.77	QP	100	63	
3	177.5178	35.63	-26.26	9.37	43.50	-34.13	QP	100	214	
4	214.6063	36.32	-24.06	12.26	43.50	-31.24	QP	100	165	
5	428.7959	33.90	-17.83	16.07	46.00	-29.93	QP	100	82	
6	790.2465	33.88	-9.25	24.63	46.00	-21.37	QP	100	61	



ACCURATE TECHNOLOGY CO., LTD.

F1,Bldg,A,Changyuan New Material Port Keyuan Rd,
Science & Industry Park,Nanshan Shenzhen,P.R.China

Site: 1# Chamber
Tel:+86-0755-26503290
Fax:+86-0755-26503396

Job No.: FRANK2019-W #361	Polarization: Vertical
Standard: FCC Class B 3M Radiated	Power Source: DC 3.7V
Test item: Radiation Test	Date: 19/11/05/
Temp.(C)/Hum.(%) 25 C / 55 %	Time: 17/20/31
EUT: Bluetooth earphone	Engineer Signature: CHARLEY
Mode: TX2441MHz	Distance: 3m
Model: BL1	
Manufacturer: Dongguan Luxun Electronic Technology Co., Ltd	

Note: Report NO.:ATE20191613

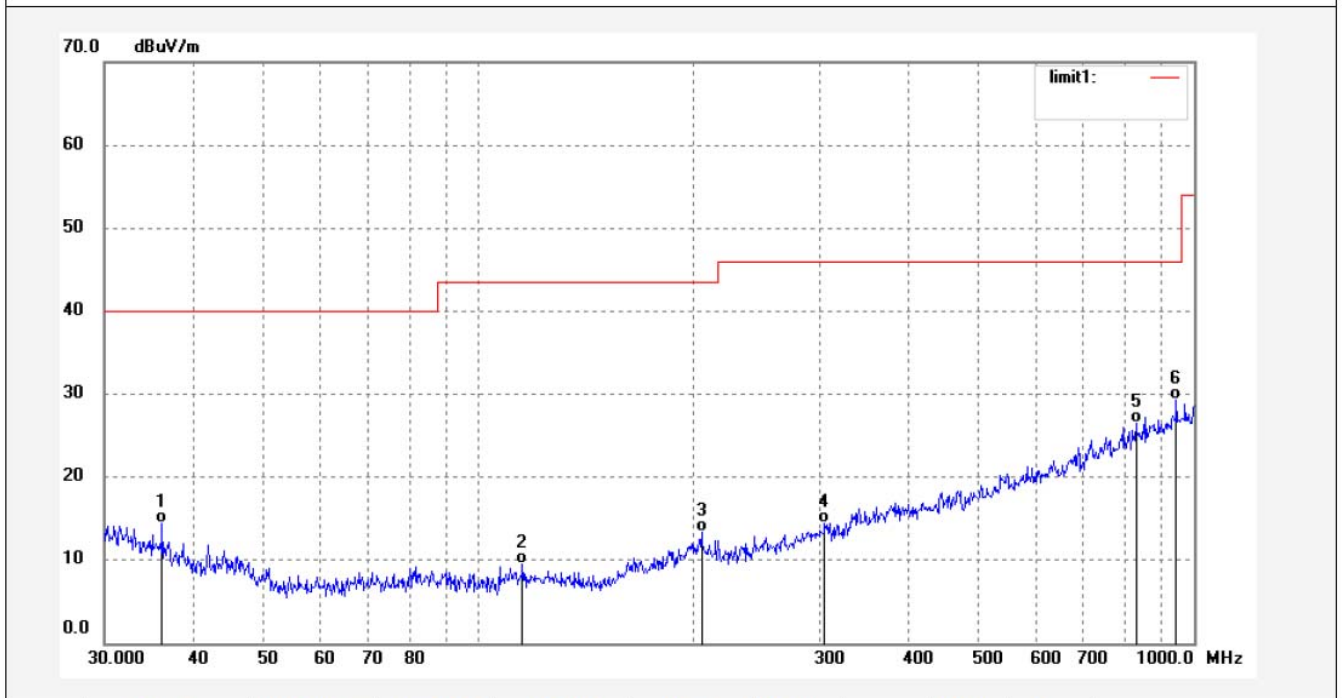

No.	Freq. (MHz)	Reading (dBuV/m)	Factor (dB)	Result (dBuV/m)	Limit (dBuV/m)	Margin (dB)	Detector	Height (cm)	Degree (deg.)	Remark
1	36.1405	36.46	-21.95	14.51	40.00	-25.49	QP	100	214	
2	115.2266	36.90	-27.35	9.55	43.50	-33.95	QP	100	166	
3	205.0243	37.51	-24.16	13.35	43.50	-30.15	QP	100	82	
4	304.9547	35.59	-21.07	14.52	46.00	-31.48	QP	100	215	
5	830.0909	34.90	-8.39	26.51	46.00	-19.49	QP	100	63	
6	945.3336	35.70	-6.41	29.29	46.00	-16.71	QP	100	189	



ACCURATE TECHNOLOGY CO., LTD.

F1,Bldg,A,Changyuan New Material Port Keyuan Rd,
Science & Industry Park,Nanshan Shenzhen,P.R.China

Site: 1# Chamber
Tel:+86-0755-26503290
Fax:+86-0755-26503396

Job No.: FRANK2019-W #362
Standard: FCC Class B 3M Radiated
Test item: Radiation Test
Temp.(C)/Hum.(%) 25 C / 55 %
EUT: Bluetooth earphone
Mode: TX2441MHz
Model: BL1
Manufacturer: Dongguan Luxun Electronic Technology Co., Ltd

Polarization: Horizontal
Power Source: DC 3.7V
Date: 19/11/05/
Time: 17/22/51
Engineer Signature: CHARLEY
Distance: 3m

Note: Report NO.:ATE20191613

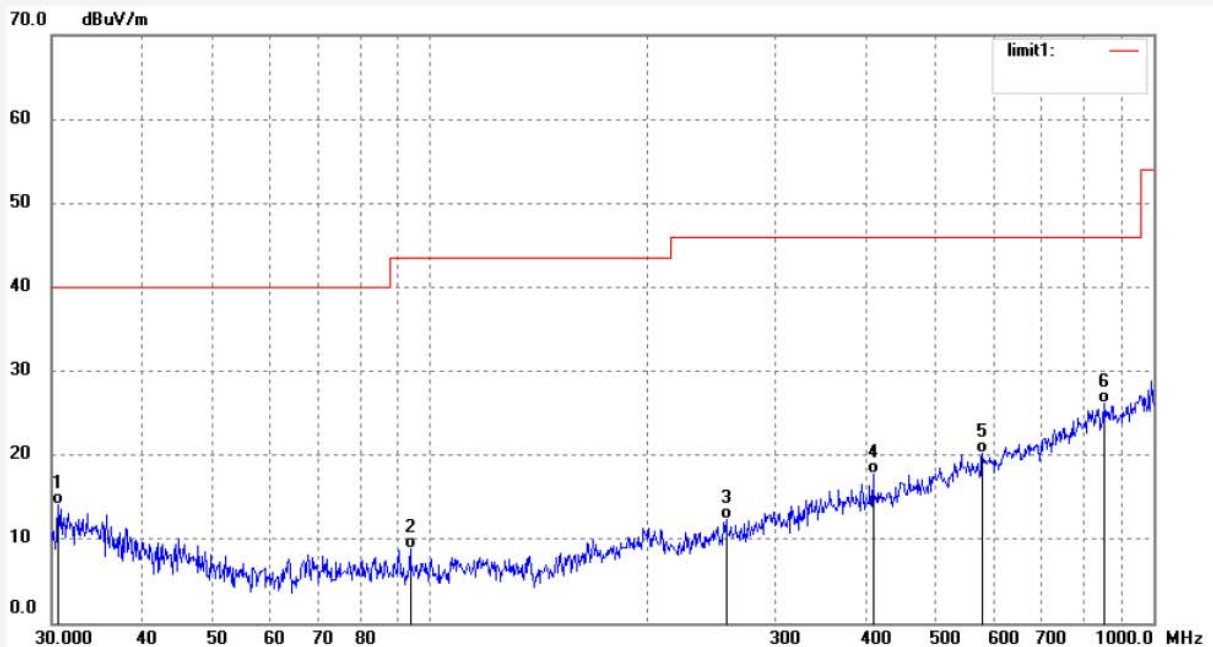

No.	Freq. (MHz)	Reading (dBuV/m)	Factor (dB)	Result (dBuV/m)	Limit (dBuV/m)	Margin (dB)	Detector	Height (cm)	Degree (deg.)	Remark
1	30.6391	34.46	-20.36	14.10	40.00	-25.90	QP	200	182	
2	93.9829	36.27	-27.42	8.85	43.50	-34.65	QP	200	211	
3	256.7230	35.53	-23.25	12.28	46.00	-33.72	QP	200	93	
4	409.6505	35.91	-18.12	17.79	46.00	-28.21	QP	200	189	
5	580.0705	34.25	-14.11	20.14	46.00	-25.86	QP	200	328	
6	853.7546	34.17	-7.98	26.19	46.00	-19.81	QP	200	82	



ACCURATE TECHNOLOGY CO., LTD.

F1,Bldg,A,Changyuan New Material Port Keyuan Rd,
Science & Industry Park,Nanshan Shenzhen,P.R.China

Site: 1# Chamber
Tel:+86-0755-26503290
Fax:+86-0755-26503396

Job No.: FRANK2019-W #363	Polarization: Horizontal
Standard: FCC Class B 3M Radiated	Power Source: DC 3.7V
Test item: Radiation Test	Date: 19/11/05/
Temp.(C)/Hum.(%) 25 C / 55 %	Time: 17/24/02
EUT: Bluetooth earphone	Engineer Signature: CHARLEY
Mode: TX2480MHz	Distance: 3m
Model: BL1	
Manufacturer: Dongguan Luxun Electronic Technology Co., Ltd	

Note: Report NO.:ATE20191613

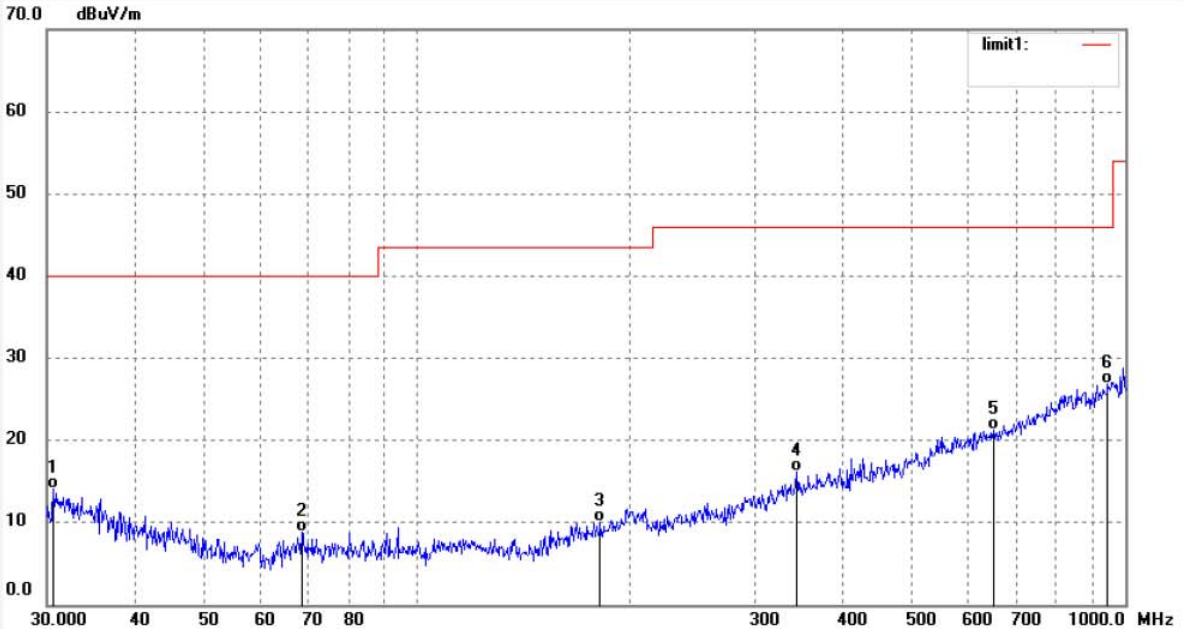

No.	Freq. (MHz)	Reading (dBuV/m)	Factor (dB)	Result (dBuV/m)	Limit (dBuV/m)	Margin (dB)	Detector	Height (cm)	Degree (deg.)	Remark
1	30.6390	34.46	-20.36	14.10	40.00	-25.90	QP	200	93	
2	68.7450	36.20	-27.43	8.77	40.00	-31.23	QP	200	215	
3	181.3000	36.03	-25.89	10.14	43.50	-33.36	QP	200	25	
4	343.6505	35.80	-19.58	16.22	46.00	-29.78	QP	200	301	
5	651.3831	33.82	-12.63	21.19	46.00	-24.81	QP	200	54	
6	945.3336	33.32	-6.41	26.91	46.00	-19.09	QP	200	198	



ACCURATE TECHNOLOGY CO., LTD.

F1,Bldg,A,Changyuan New Material Port Keyuan Rd,
Science & Industry Park,Nanshan Shenzhen,P.R.China

Site: 1# Chamber

Tel:+86-0755-26503290

Fax:+86-0755-26503396

Job No.: FRANK2019-W #364

Standard: FCC Class B 3M Radiated

Test item: Radiation Test

Temp.(C)/Hum.(%) 25 C / 55 %

EUT: Bluetooth earphone

Mode: TX2480MHz

Model: BL1

Manufacturer: Dongguan Luxun Electronic Technology Co., Ltd

Polarization: Vertical

Power Source: DC 3.7V

Date: 19/11/05/

Time: 17/26/14

Engineer Signature: CHARLEY

Distance: 3m

Note: Report NO.:ATE20191613

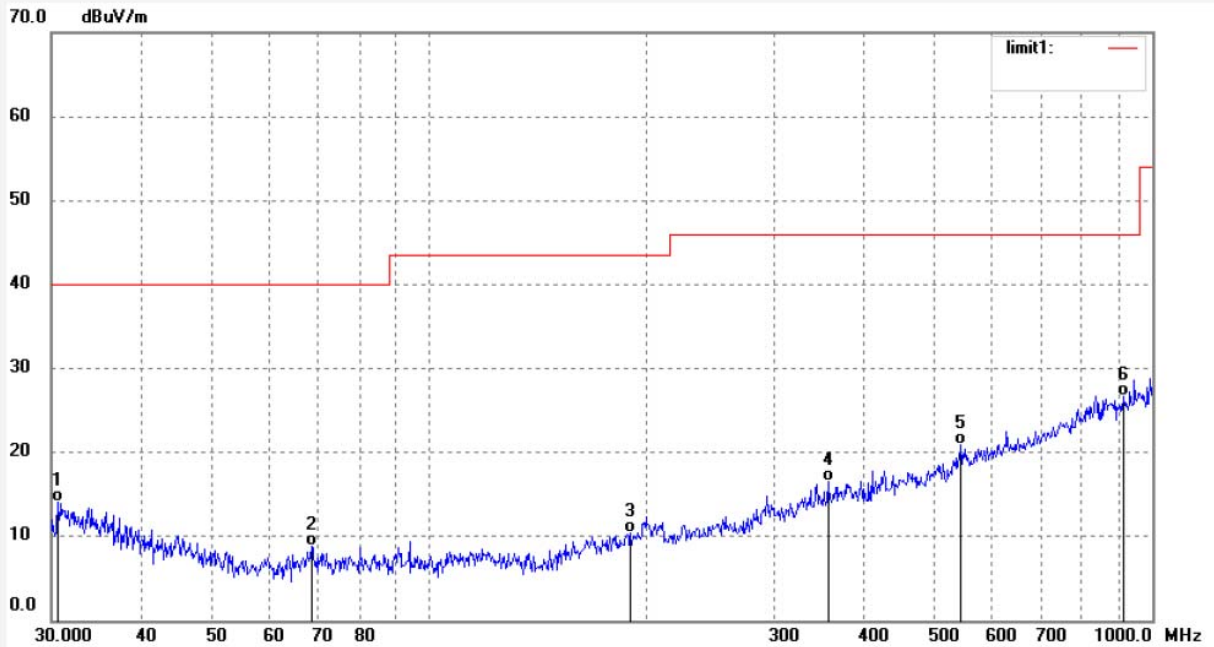

No.	Freq. (MHz)	Reading (dBuV/m)	Factor (dB)	Result (dBuV/m)	Limit (dBuV/m)	Margin (dB)	Detector	Height (cm)	Degree (deg.)	Remark
1	30.6391	34.46	-20.36	14.10	40.00	-25.90	QP	100	109	
2	68.7450	36.29	-27.43	8.86	40.00	-31.14	QP	100	324	
3	189.7732	35.48	-25.14	10.34	43.50	-33.16	QP	100	210	
4	355.9397	35.64	-19.09	16.55	46.00	-29.45	QP	100	55	
5	544.5202	35.94	-14.97	20.97	46.00	-25.03	QP	100	218	
6	912.6952	33.74	-6.97	26.77	46.00	-19.23	QP	100	321	

Above 1GHz



ACCURATE TECHNOLOGY CO., LTD.

F1,Bldg,A,Changyuan New Material Port Keyuan Rd,
Science & Industry Park,Nanshan Shenzhen,P.R.China

Site: 2# Chamber
Tel:+86-0755-26503290
Fax:+86-0755-26503396

Job No.: FRANK2019-W #438

Standard: FCC PK

Test item: Radiation Test

Temp.(C)/Hum.(%) 25 C / 55 %

EUT: Bluetooth earphone

Mode: TX2402MHz(GFSK)

Model: BL1

Manufacturer: Dongguan Luxun Electronic Technology Co., Ltd

Polarization: Horizontal

Power Source: DC 3.7V

Date: 2019/11/11

Time: 11:01:56

Engineer Signature:

Distance: 3m

Note: Report NO.:ATE20191613

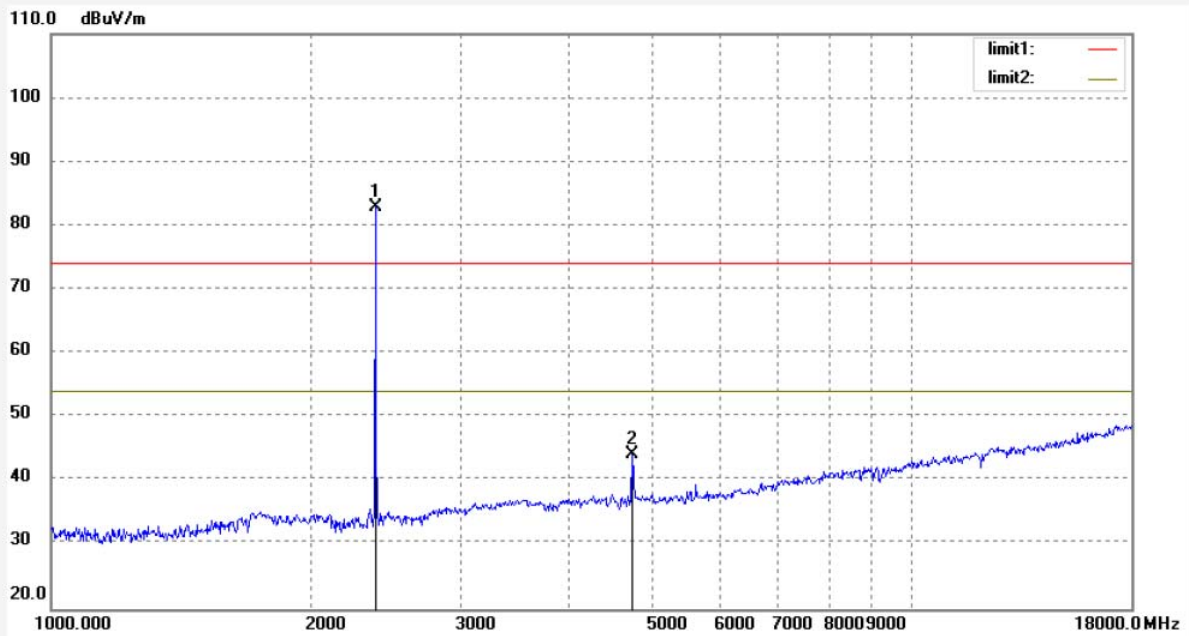

No.	Freq. (MHz)	Reading (dBuV/m)	Factor (dB)	Result (dBuV/m)	Limit (dBuV/m)	Margin (dB)	Detector	Height (cm)	Degree (deg.)	Remark
1	2402.000	89.17	-6.37	82.80			peak	200	136	
2	4804.000	43.39	0.70	44.09	74.00	-29.91	peak	200	331	



ACCURATE TECHNOLOGY CO., LTD.

F1,Bldg,A,Changyuan New Material Port Keyuan Rd,
Science & Industry Park,Nanshan Shenzhen,P.R.China

Site: 2# Chamber
Tel:+86-0755-26503290
Fax:+86-0755-26503396

Job No.: FRANK2019-W #439

Polarization: Vertical

Standard: FCC PK

Power Source: DC 3.7V

Test item: Radiation Test

Date: 2019/11/11

Temp.(C)/Hum.(%) 25 C / 55 %

Time: 11:03:18

EUT: Bluetooth earphone

Engineer Signature:

Mode: TX2402MHz(GFSK)

Distance: 3m

Model: BL1

Manufacturer: Dongguan Luxun Electronic Technology Co., Ltd

Note: Report NO.:ATE20191613

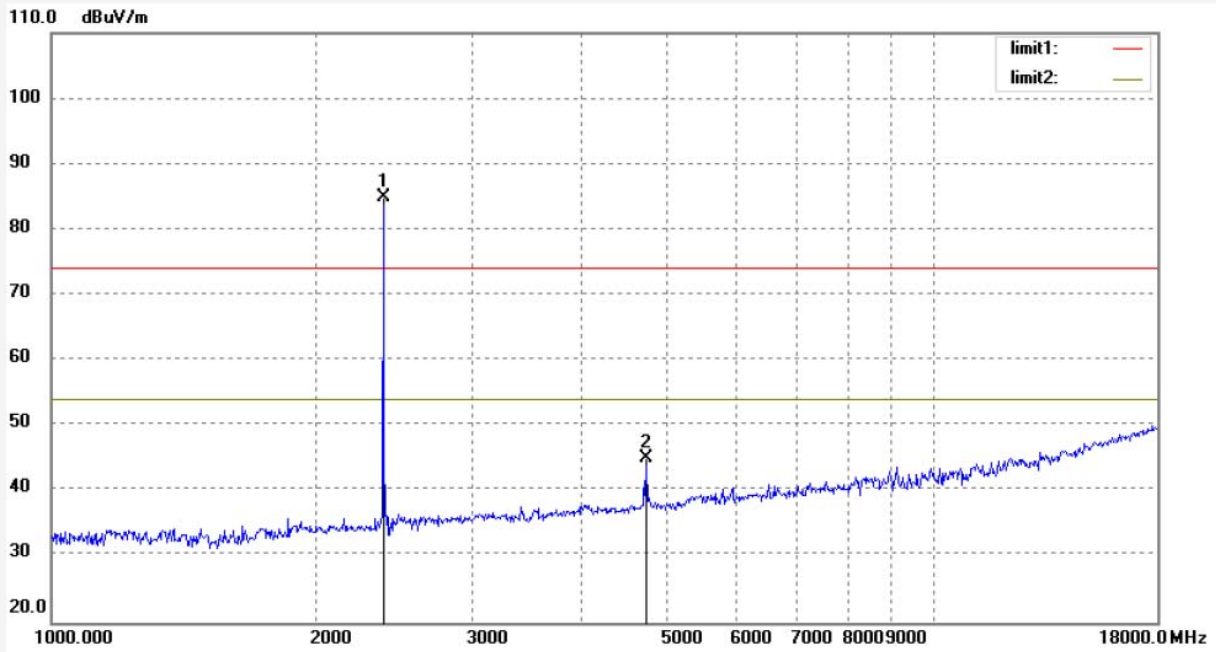

No.	Freq. (MHz)	Reading (dBuV/m)	Factor (dB)	Result (dBuV/m)	Limit (dBuV/m)	Margin (dB)	Detector	Height (cm)	Degree (deg.)	Remark
1	2402.000	91.31	-6.37	84.94			peak	150	105	
2	4804.000	44.32	0.70	45.02	74.00	-28.98	peak	150	302	



ACCURATE TECHNOLOGY CO., LTD.

F1,Bldg,A,Changyuan New Material Port Keyuan Rd,
Science & Industry Park,Nanshan Shenzhen,P.R.China

Site: 2# Chamber
Tel:+86-0755-26503290
Fax:+86-0755-26503396

Job No.: FRANK2019-W #440

Standard: FCC PK

Test item: Radiation Test

Temp.(C)/Hum.(%) 25 C / 55 %

EUT: Bluetooth earphone

Mode: TX2441MHz(GFSK)

Model: BL1

Manufacturer: Dongguan Luxun Electronic Technology Co., Ltd

Polarization: Vertical

Power Source: DC 3.7V

Date: 2019/11/11

Time: 11:05:46

Engineer Signature:

Distance: 3m

Note: Report NO.:ATE20191613

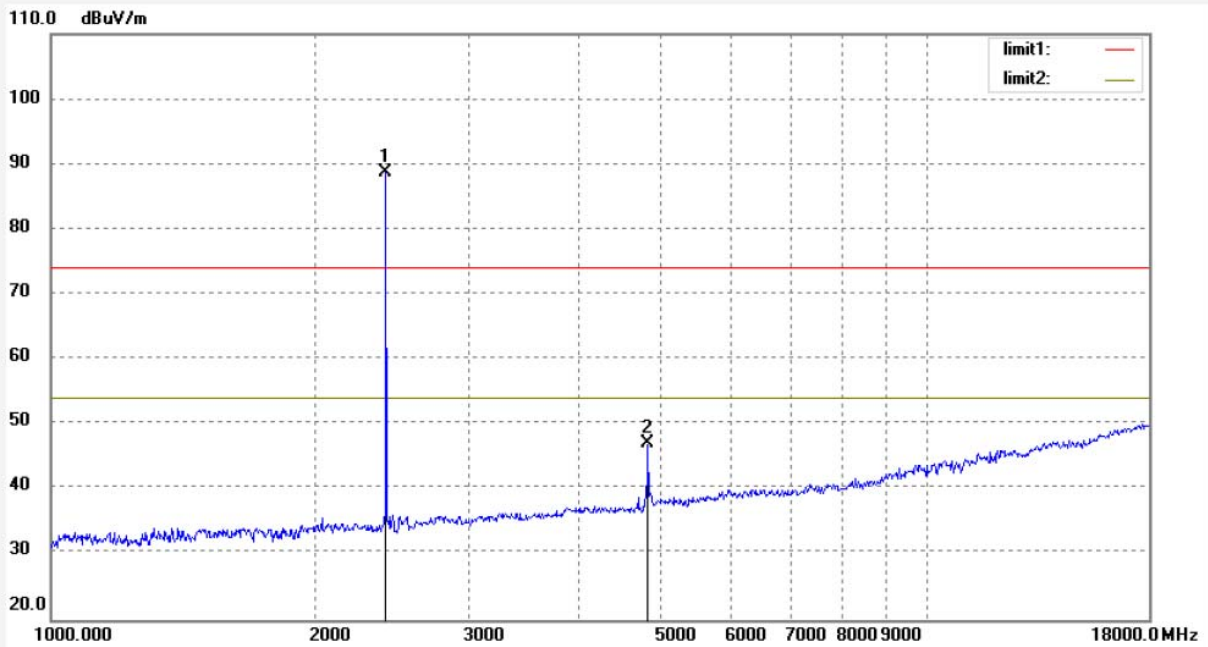

No.	Freq. (MHz)	Reading (dBuV/m)	Factor (dB)	Result (dBuV/m)	Limit (dBuV/m)	Margin (dB)	Detector	Height (cm)	Degree (deg.)	Remark
1	2441.000	95.03	-6.20	88.83	74.00		peak	150	326	
2	4882.000	46.02	1.07	47.09	74.00	-26.91	peak	150	119	



ACCURATE TECHNOLOGY CO., LTD.

F1,Bldg,A,Changyuan New Material Port Keyuan Rd,
Science & Industry Park,Nanshan Shenzhen,P.R.China

Site: 2# Chamber

Tel:+86-0755-26503290

Fax:+86-0755-26503396

Job No.: FRANK2019-W #441

Standard: FCC PK

Test item: Radiation Test

Temp.(C)/Hum.(%) 25 C / 55 %

EUT: Bluetooth earphone

Mode: TX2441MHz(GFSK)

Model: BL1

Manufacturer: Dongguan Luxun Electronic Technology Co., Ltd

Polarization: Horizontal

Power Source: DC 3.7V

Date: 2019/11/11

Time: 11:07:52

Engineer Signature:

Distance: 3m

Note: Report NO.:ATE20191613

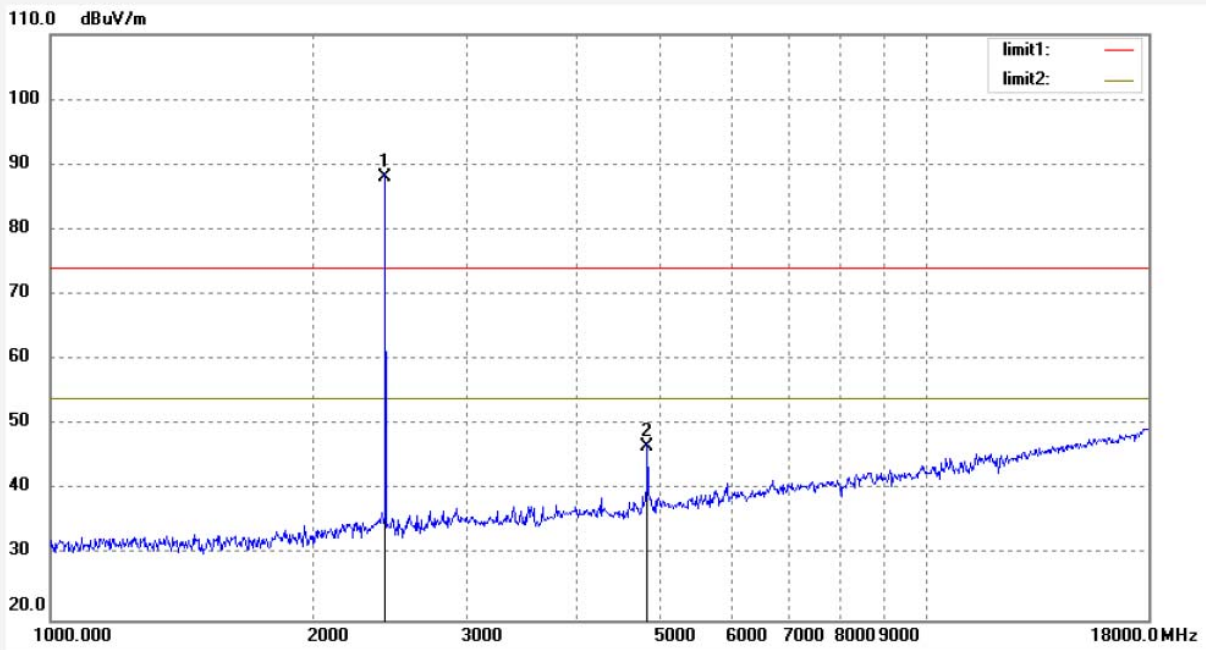

No.	Freq. (MHz)	Reading (dBuV/m)	Factor (dB)	Result (dBuV/m)	Limit (dBuV/m)	Margin (dB)	Detector	Height (cm)	Degree (deg.)	Remark
1	2441.000	94.35	-6.20	88.15			peak	200	91	
2	4882.000	45.66	1.07	46.73	74.00	-27.27	peak	200	103	



ACCURATE TECHNOLOGY CO., LTD.

F1,Bldg,A,Changyuan New Material Port Keyuan Rd,
Science & Industry Park,Nanshan Shenzhen,P.R.China

Site: 2# Chamber
Tel:+86-0755-26503290
Fax:+86-0755-26503396

Job No.: FRANK2019-W #442

Polarization: Horizontal

Standard: FCC PK

Power Source: DC 3.7V

Test item: Radiation Test

Date: 2019/11/11

Temp.(C)/Hum.(%) 25 C / 55 %

Time: 11:09:50

EUT: Bluetooth earphone

Engineer Signature:

Mode: TX2480MHz(GFSK)

Distance: 3m

Model: BL1

Manufacturer: Dongguan Luxun Electronic Technology Co., Ltd

Note: Report NO.:ATE20191613

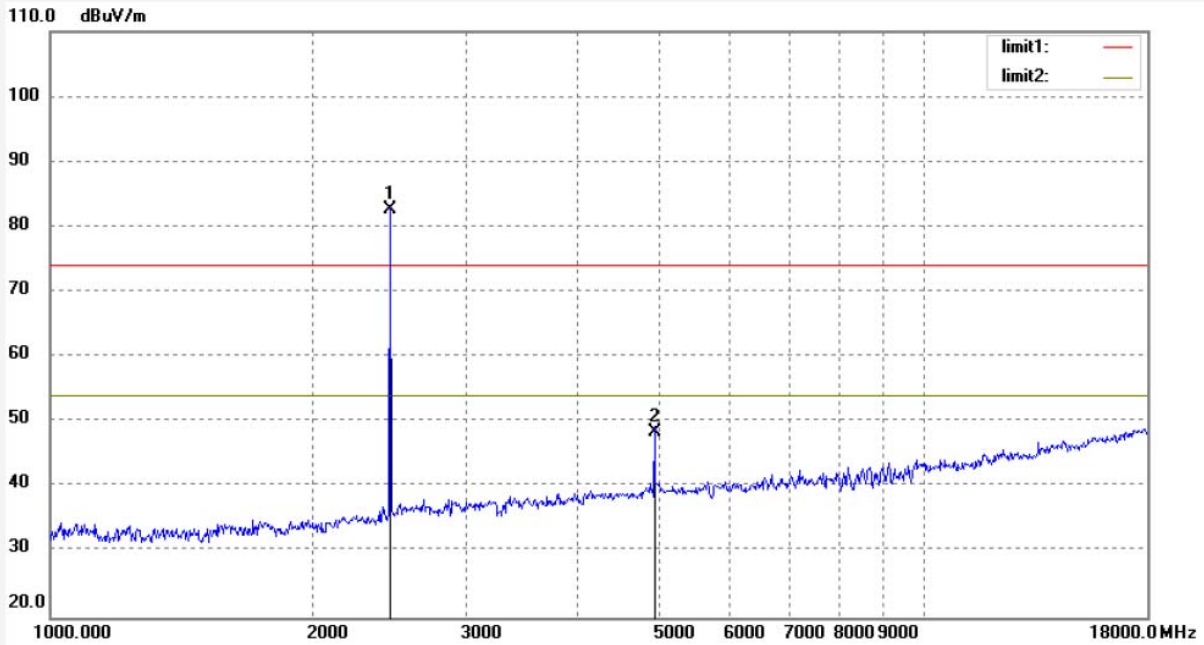

No.	Freq. (MHz)	Reading (dBuV/m)	Factor (dB)	Result (dBuV/m)	Limit (dBuV/m)	Margin (dB)	Detector	Height (cm)	Degree (deg.)	Remark
1	2480.000	88.68	-6.04	82.64			peak	200	146	
2	4960.000	46.98	1.50	48.48	74.00	-25.52	peak	200	321	



ACCURATE TECHNOLOGY CO., LTD.

F1,Bldg,A,Changyuan New Material Port Keyuan Rd,
Science & Industry Park,Nanshan Shenzhen,P.R.China

Site: 2# Chamber
Tel:+86-0755-26503290
Fax:+86-0755-26503396

Job No.: FRANK2019-W #443

Standard: FCC PK

Test item: Radiation Test

Temp.(C)/Hum.(%) 25 C / 55 %

EUT: Bluetooth earphone

Mode: TX2480MHz(GFSK)

Model: BL1

Manufacturer: Dongguan Luxun Electronic Technology Co., Ltd

Polarization: Vertical

Power Source: DC 3.7V

Date: 2019/11/11

Time: 11:11:50

Engineer Signature:

Distance: 3m

Note: Report NO.:ATE20191613

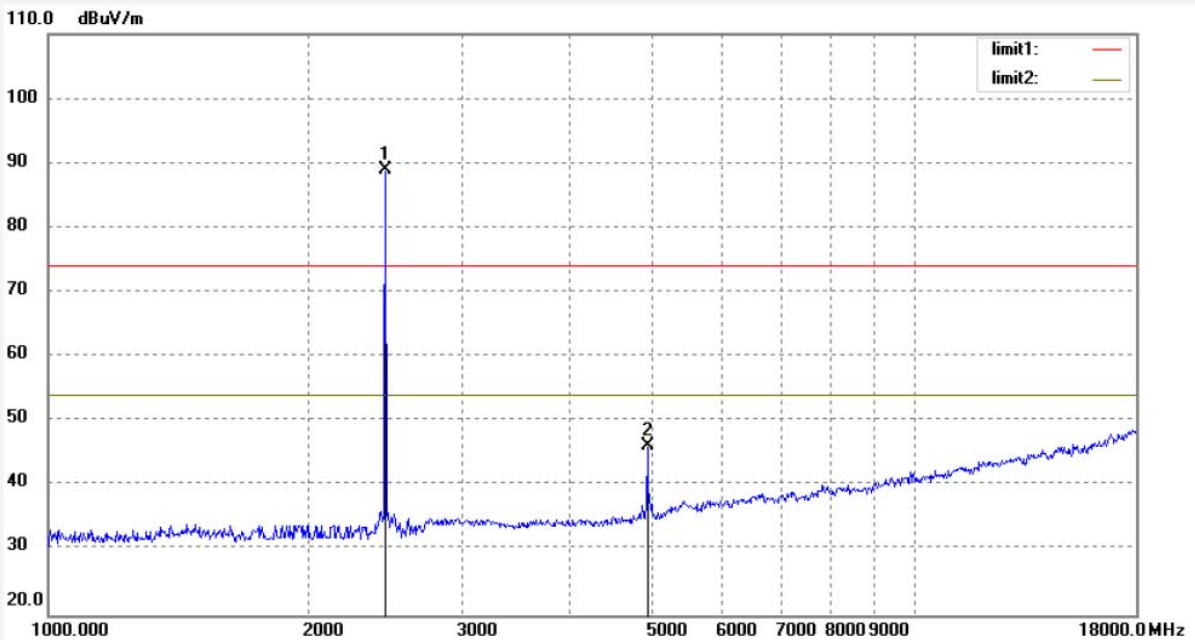

No.	Freq. (MHz)	Reading (dBuV/m)	Factor (dB)	Result (dBuV/m)	Limit (dBuV/m)	Margin (dB)	Detector	Height (cm)	Degree (deg.)	Remark
1	2480.000	95.01	-6.04	88.97			peak	150	219	
2	4960.000	44.65	1.50	46.15	74.00	-27.85	peak	150	305	

12. BAND EDGE COMPLIANCE TEST

12.1. Block Diagram of Test Setup

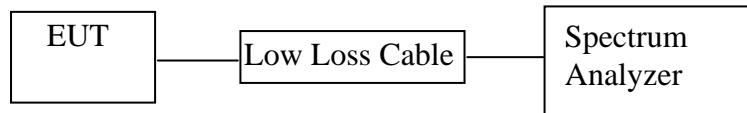

12.2. The Requirement For Section 15.247(d)

Section 15.247(d): In any 100 kHz bandwidth outside the frequency band in which the spread spectrum or digitally modulated intentional radiator is operating, the radio frequency power that is produced by the intentional radiator shall be at least 20 dB below that in the 100 kHz bandwidth within the band that contains the highest level of the desired power, based on either an RF conducted or a radiated measurement, provided the transmitter demonstrates compliance with the peak conducted power limits. If the transmitter complies with the conducted power limits based on the use of RMS averaging over a time interval, as permitted under paragraph (b)(3) of this section, the attenuation required under this paragraph shall be 30 dB instead of 20 dB. Attenuation below the general limits specified in Section 15.209(a) is not required. In addition, radiated emissions which fall in the restricted bands, as defined in Section 15.205(a), must also comply with the radiated emission limits specified in Section 15.209(a).

12.3. EUT Configuration on Measurement

The equipment are installed on the emission Measurement to meet the commission requirements and operating regulations in a manner which tends to maximize its emission characteristics in normal application.

12.4. Operating Condition of EUT

12.4.1. Setup the EUT and simulator as shown as Section 11.1.

12.4.2. Turn on the power of all equipment.

12.4.3. Let the EUT work in TX (Hopping off, Hopping on) modes measure it. The transmit frequency are 2402-2480MHz. We select 2402MHz, 2480MHz TX frequency to transmit.

12.5. Test Procedure

12.5.1. The transmitter output was connected to the spectrum analyzer via a low loss cable.

12.5.2. Set RBW of spectrum analyzer to 100 kHz and VBW to 300 kHz with convenient frequency span including 100 kHz bandwidth from band edge.

12.5.3. The band edges was measured and recorded.

12.6. Test Result

Note: Both hopping-on mode and hopping-off mode had been pre-tested, and only the Worse case was recorded in the test report.

Conducted Band Edge Result

Non-hopping mode

Frequency (MHz)	Result of Band Edge (dBc)	Limit of Band Edge (dBc)	Result
GFSK Mode			
2400.00	38.65	> 20dBc	Pass
2483.50	43.13	> 20dBc	Pass
$\Pi/4$-DQPSK Mode			
2400.00	37.51	> 20dBc	Pass
2483.50	41.30	> 20dBc	Pass
8DPSK Mode			
2400.00	38.80	> 20dBc	Pass
2483.50	43.36	> 20dBc	Pass

The spectrum analyzer plots are attached as below.

GFSK Mode

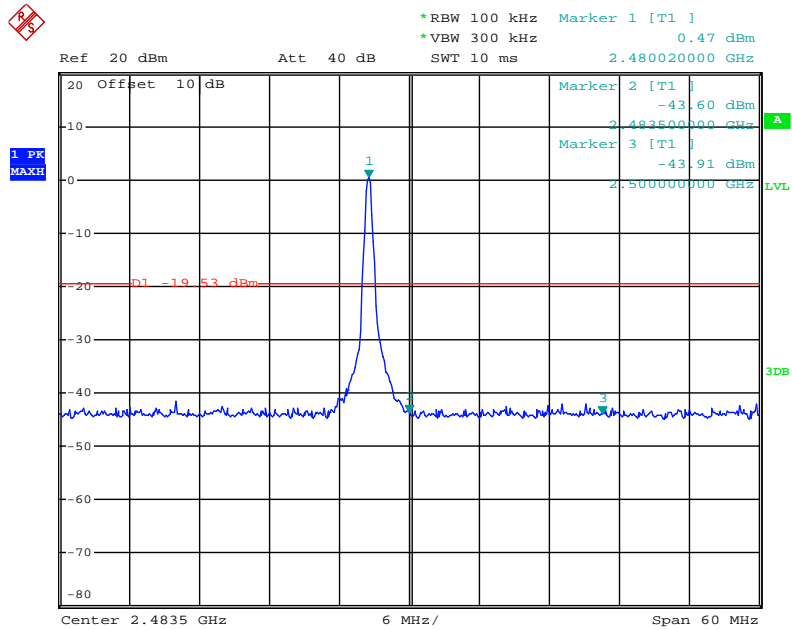
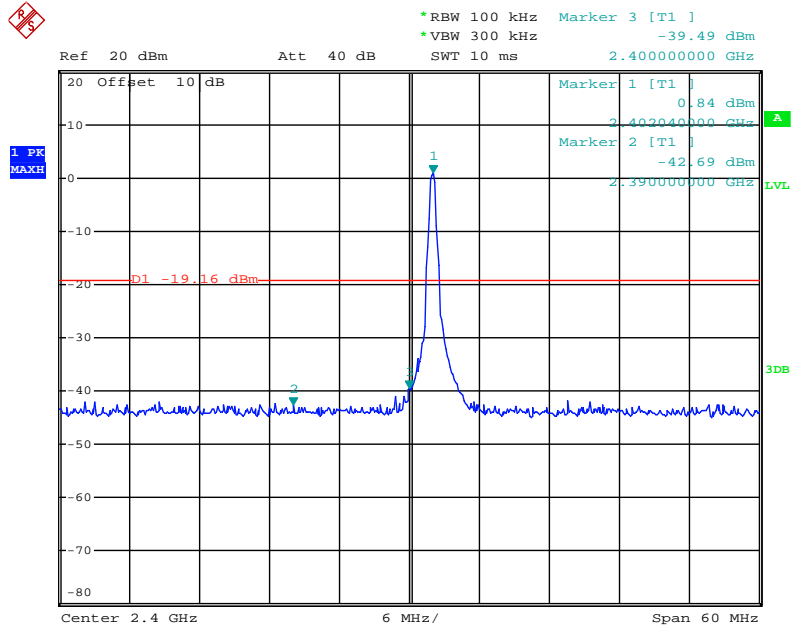

π/4-DQPSK Mode

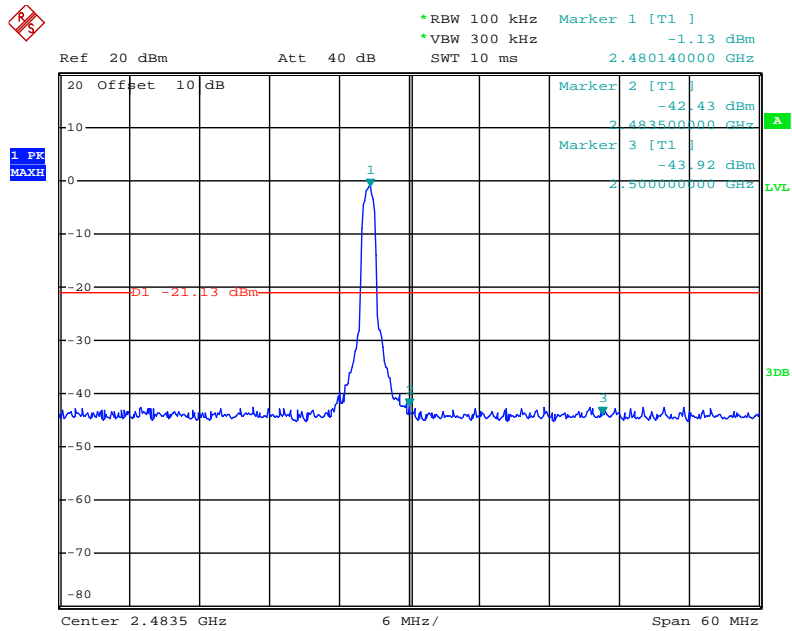
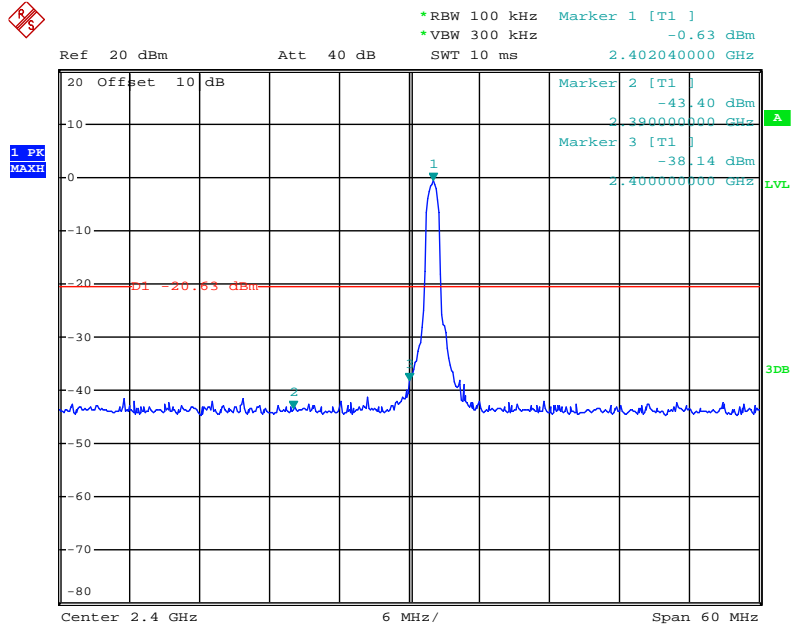

8DPSK Mode

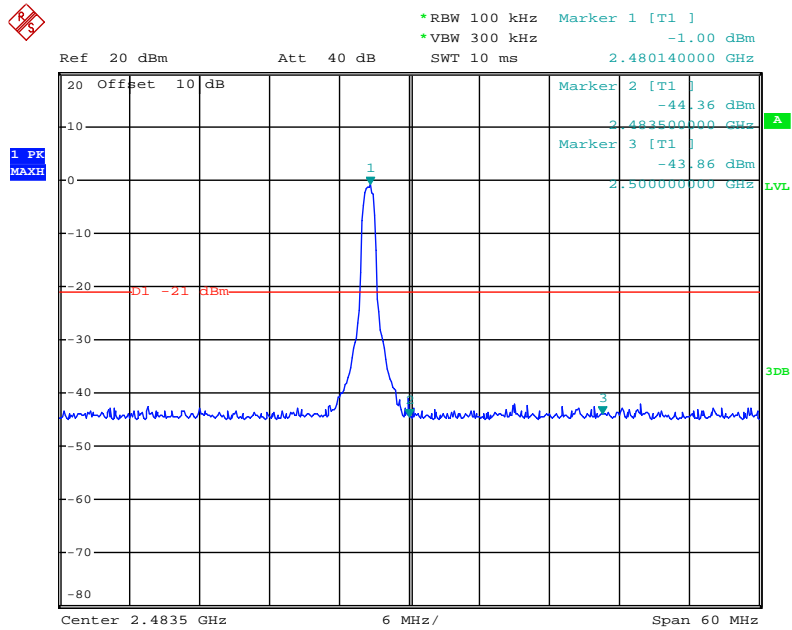
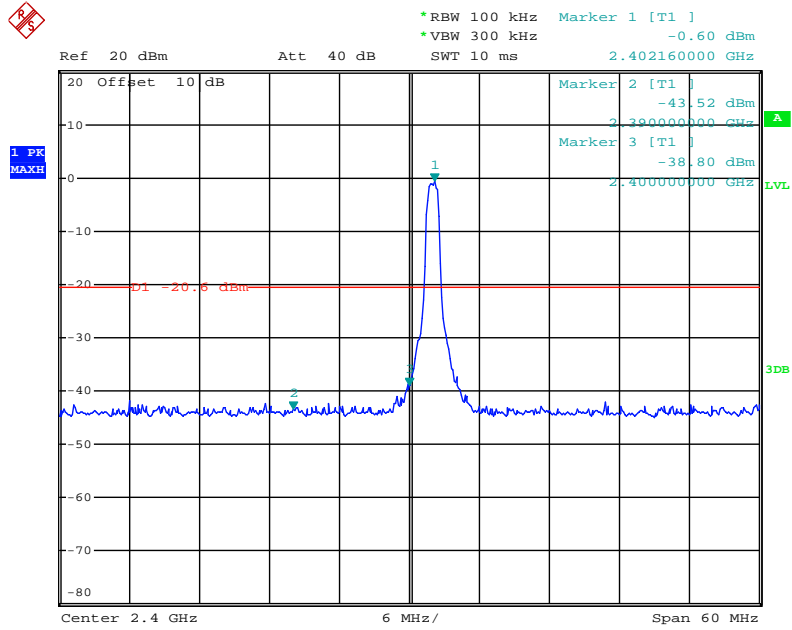

Radiated Band Edge Result

Note:

1. Emissions attenuated more than 20 dB below the permissible value are not reported.
2. The field strength is calculated by adding the antenna factor, high pass filter loss(if used) and cable loss, and subtracting the amplifier gain(if any)from the measured reading. The basic equation calculation is as follows:

Result = Reading + Corrected Factor

3. Display the measurement of peak values.

Test Procedure:

The EUT and its simulators are placed on a turntable, which is 1.5 meter high above ground(Above 1GHz). The turntable can rotate 360 degrees to determine the position of the maximum emission level. EUT is set 3.0 meters away from the receiving antenna, which is mounted on an antenna tower. The antenna can be moved up and down between 1.0 meter and 4 meters to find out the maximum emission level. Broadband antenna (calibrated bi-log antenna) is used as receiving antenna. Both horizontal and vertical polarizations of the antenna are set on measurement. In order to find the maximum emission levels, all of the EUT location must be manipulated according to ANSI C63.10:2013 on radiated emission measurement. The EUT was tested in 3 orthogonal planes.

Let the EUT work in TX (Hopping off, Hopping on) modes measure it.
We select 2402MHz, 2480MHz TX frequency to transmit(Hopping off mode).
We select 2402-2480MHz TX frequency to transmit(Hopping on mode).

During the radiated emission test, the spectrum analyzer was set with the following configurations:

- 1.The resolution bandwidth of test receiver/spectrum analyzer is 1MHz and video bandwidth is 3MHz for peak measurement with peak detector at frequency above 1GHz.
- 2.The resolution bandwidth of test receiver/spectrum analyzer is 1MHz and video bandwidth is 10Hz for Average measurement with peak detection at frequency above 1GHz.
- 3.All modes of operation were investigated and the worse case (GFSK Mode) emissions are reported.

Test Lab: 3m Anechoic chamber

The spectrum analyzer plots are attached as below.

Non-hopping mode



ACCURATE TECHNOLOGY CO., LTD.

F1,Bldg,A,Changyuan New Material Port Keyuan Rd,
Science & Industry Park,Nanshan Shenzhen,P.R.China

Site: 2# Chamber

Tel:+86-0755-26503290

Fax:+86-0755-26503396

Job No.: FRANK2019-W #454	Polarization: Horizontal
Standard: FCC PK	Power Source: DC 3.7V
Test item: Radiation Test	Date: 2019/11/11
Temp.(C)/Hum.(%) 25 C / 55 %	Time: 11:26:24
EUT: Bluetooth earphone	Engineer Signature:
Mode: TX2402MHz(GFSK)	Distance: 3m
Model: BL1	
Manufacturer: Dongguan Luxun Electronic Technology Co., Ltd	

Note: Report NO.:ATE20191613

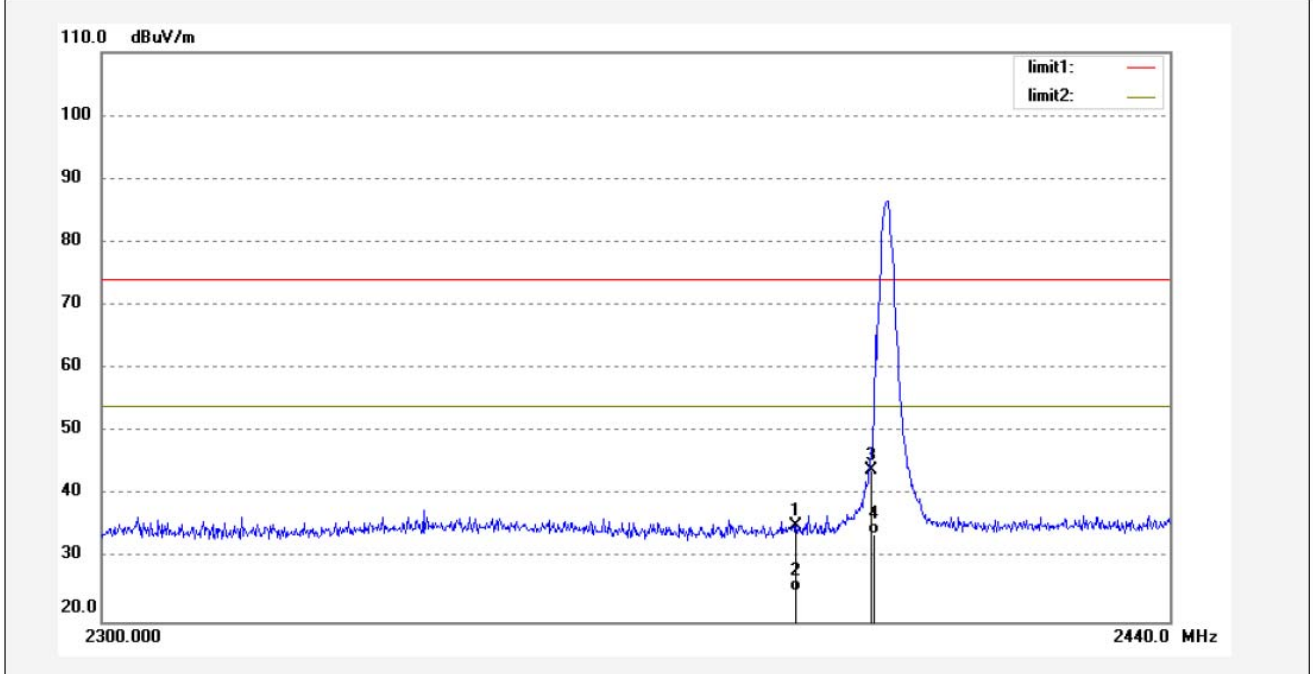

No.	Freq. (MHz)	Reading (dBuV/m)	Factor (dB)	Result (dBuV/m)	Limit (dBuV/m)	Margin (dB)	Detector	Height (cm)	Degree (deg.)	Remark
1	2390.000	41.48	-6.32	35.16	74.00	-38.84	peak	200	348	
2	2390.000	31.12	-6.32	24.80	54.00	-29.20	AVG	200	62	
3	2400.000	50.15	-6.27	43.88	74.00	-30.12	peak	200	218	
4	2400.000	40.12	-6.27	33.85	54.00	-20.15	AVG	200	309	

Note: Average measurement with peak detection at No.2&4



ACCURATE TECHNOLOGY CO., LTD.

F1,Bldg,A,Changyuan New Material Port Keyuan Rd,
Science & Industry Park,Nanshan Shenzhen,P.R.China

Site: 2# Chamber

Tel:+86-0755-26503290

Fax:+86-0755-26503396

Job No.: FRANK2019-W #455	Polarization: Vertical
Standard: FCC PK	Power Source: DC 3.7V
Test item: Radiation Test	Date: 2019/11/11
Temp.(C)/Hum.(%) 25 C / 55 %	Time: 11:31:46
EUT: Bluetooth earphone	Engineer Signature:
Mode: TX2402MHz(GFSK)	Distance: 3m
Model: BL1	
Manufacturer: Dongguan Luxun Electronic Technology Co., Ltd	

Note: Report NO.:ATE20191613

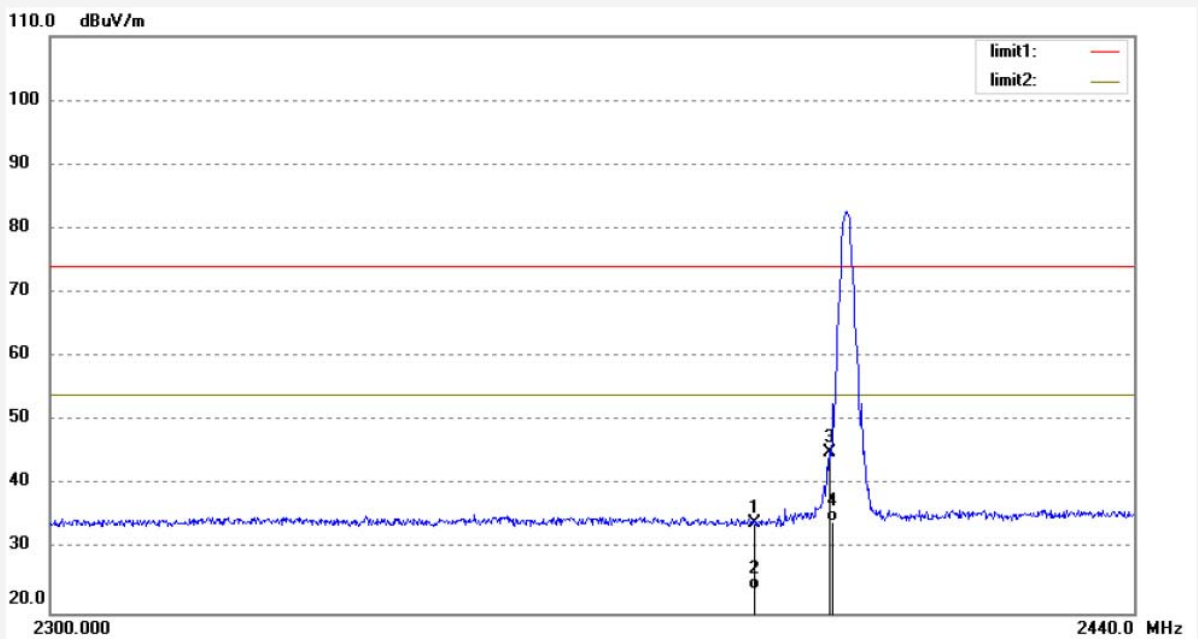

No.	Freq. (MHz)	Reading (dBuV/m)	Factor (dB)	Result (dBuV/m)	Limit (dBuV/m)	Margin (dB)	Detector	Height (cm)	Degree (deg.)	Remark
1	2390.000	40.41	-6.32	34.09	74.00	-39.91	peak	150	302	
2	2390.000	30.12	-6.32	23.80	54.00	-30.20	AVG	150	125	
3	2400.000	51.32	-6.27	45.05	74.00	-28.95	peak	150	63	
4	2400.000	40.64	-6.27	34.37	54.00	-19.63	AVG	150	146	

Note: Average measurement with peak detection at No.2&4



ACCURATE TECHNOLOGY CO., LTD.

F1,Bldg,A,Changyuan New Material Port Keyuan Rd,
Science & Industry Park,Nanshan Shenzhen,P.R.China

Site: 2# Chamber
Tel:+86-0755-26503290
Fax:+86-0755-26503396

Job No.: FRANK2019-W #444	Polarization: Vertical
Standard: FCC PK	Power Source: DC 3.7V
Test item: Radiation Test	Date: 2019/11/11
Temp.(C)/Hum.(%) 25 C / 55 %	Time: 11:12:33
EUT: Bluetooth earphone	Engineer Signature:
Mode: TX2480MHz(GFSK)	Distance: 3m
Model: BL1	
Manufacturer: Dongguan Luxun Electronic Technology Co., Ltd	

Note: Report NO.:ATE20191613

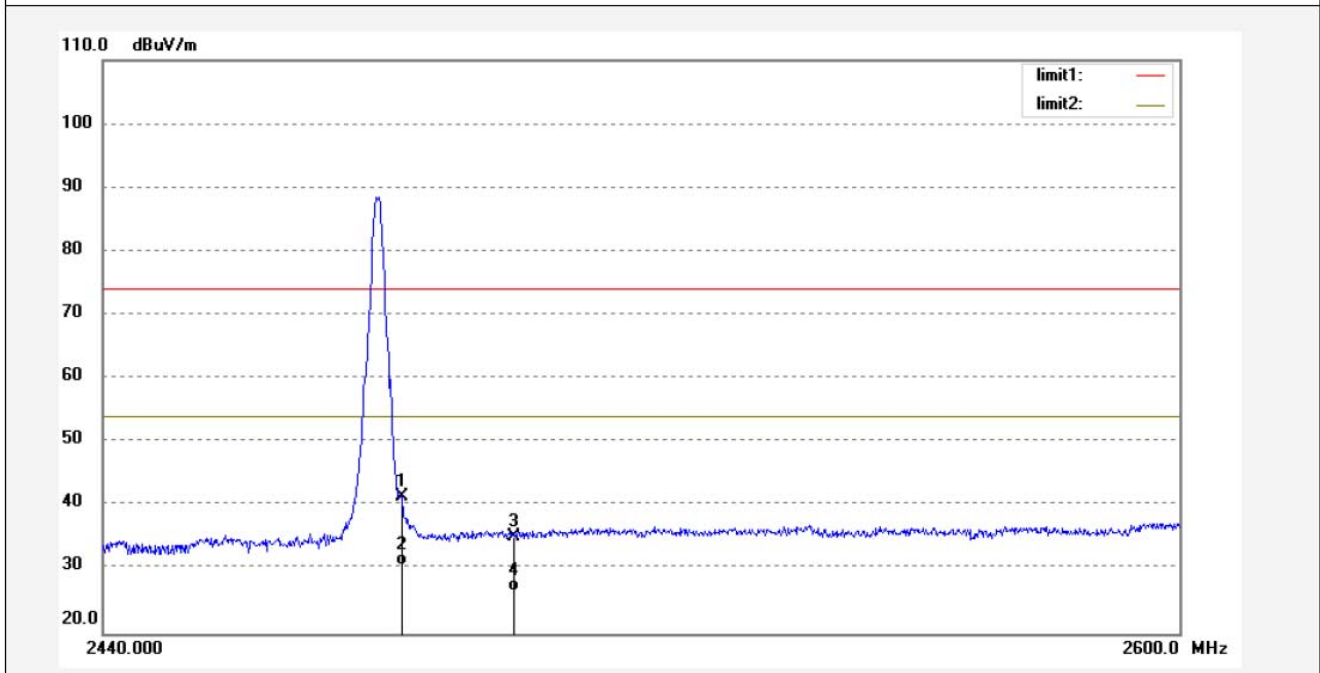

No.	Freq. (MHz)	Reading (dBuV/m)	Factor (dB)	Result (dBuV/m)	Limit (dBuV/m)	Margin (dB)	Detector	Height (cm)	Degree (deg.)	Remark
1	2483.500	47.36	-5.89	41.47	74.00	-32.53	peak	150	159	
2	2483.500	36.56	-5.89	30.67	54.00	-23.33	AVG	150	62	
3	2500.000	41.03	-5.81	35.22	74.00	-38.78	peak	150	221	
4	2500.000	32.46	-5.81	26.65	54.00	-27.35	AVG	150	93	

Note: Average measurement with peak detection at No.2&4



ACCURATE TECHNOLOGY CO., LTD.

F1,Bldg,A,Changyuan New Material Port Keyuan Rd,
Science & Industry Park,Nanshan Shenzhen,P.R.China

Site: 2# Chamber
Tel:+86-0755-26503290
Fax:+86-0755-26503396

Job No.: FRANK2019-W #445	Polarization: Horizontal
Standard: FCC PK	Power Source: DC 3.7V
Test item: Radiation Test	Date: 2019/11/11
Temp.(C)/Hum.(%) 25 C / 55 %	Time: 11:14:47
EUT: Bluetooth earphone	Engineer Signature:
Mode: TX2480MHz(GFSK)	Distance: 3m
Model: BL1	
Manufacturer: Dongguan Luxun Electronic Technology Co., Ltd	

Note: Report NO.:ATE20191613

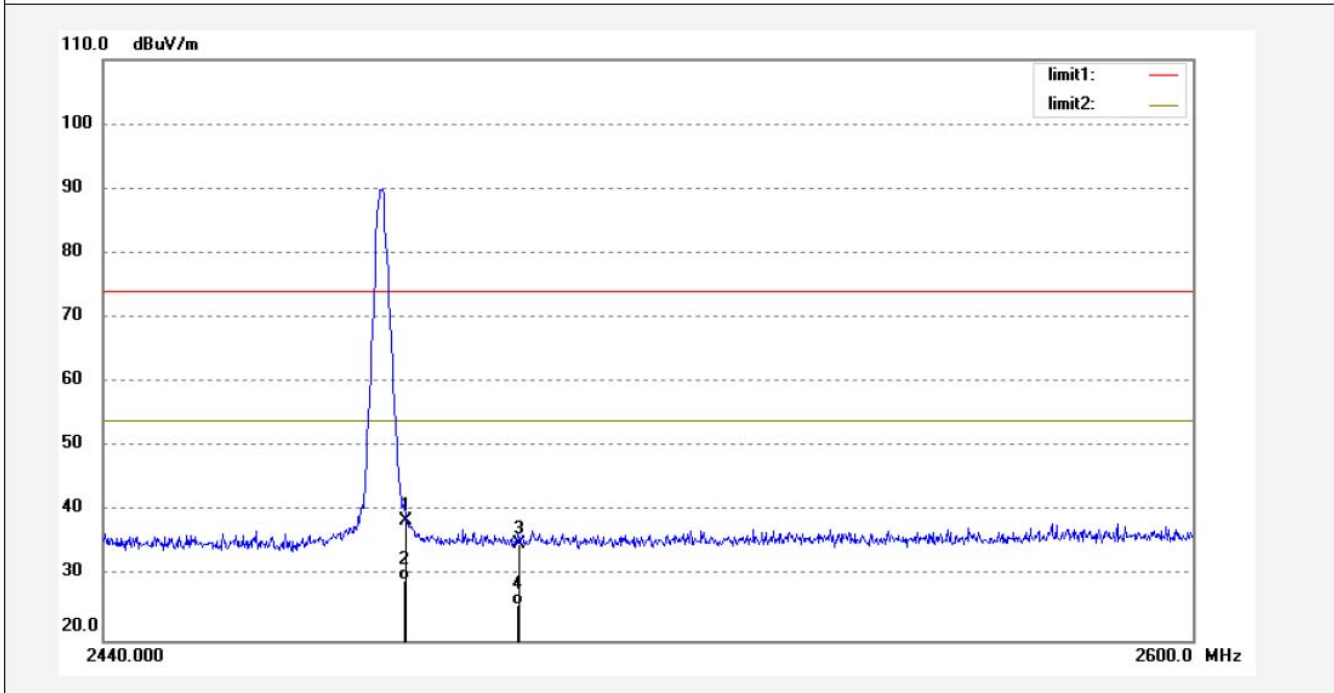

No.	Freq. (MHz)	Reading (dBuV/m)	Factor (dB)	Result (dBuV/m)	Limit (dBuV/m)	Margin (dB)	Detector	Height (cm)	Degree (deg.)	Remark
1	2483.500	44.45	-5.89	38.56	74.00	-35.44	peak	200	63	
2	2483.500	35.15	-5.89	29.26	54.00	-24.74	AVG	200	118	
3	2500.000	40.85	-5.81	35.04	74.00	-38.96	peak	200	331	
4	2500.000	31.25	-5.81	25.44	54.00	-28.56	AVG	200	196	

Note: Average measurement with peak detection at No.2&4

Hopping mode



ACCURATE TECHNOLOGY CO., LTD.

F1,Bldg,A,Changyuan New Material Port Keyuan Rd,
Science & Industry Park,Nanshan Shenzhen,P.R.China

Site: 2# Chamber
Tel:+86-0755-26503290
Fax:+86-0755-26503396

Job No.: FRANK2019-W #456

Polarization: Vertical

Standard: FCC PK

Power Source: DC 3.7V

Test item: Radiation Test

Date: 2019/11/11

Temp.(C)/Hum.(%) 25 C / 55 %

Time: 11:35:43

EUT: Bluetooth earphone

Engineer Signature:

Mode: HOPPING(GFSK)

Distance: 3m

Model: BL1

Manufacturer: Dongguan Luxun Electronic Technology Co., Ltd

Note: Report NO.:ATE20191613

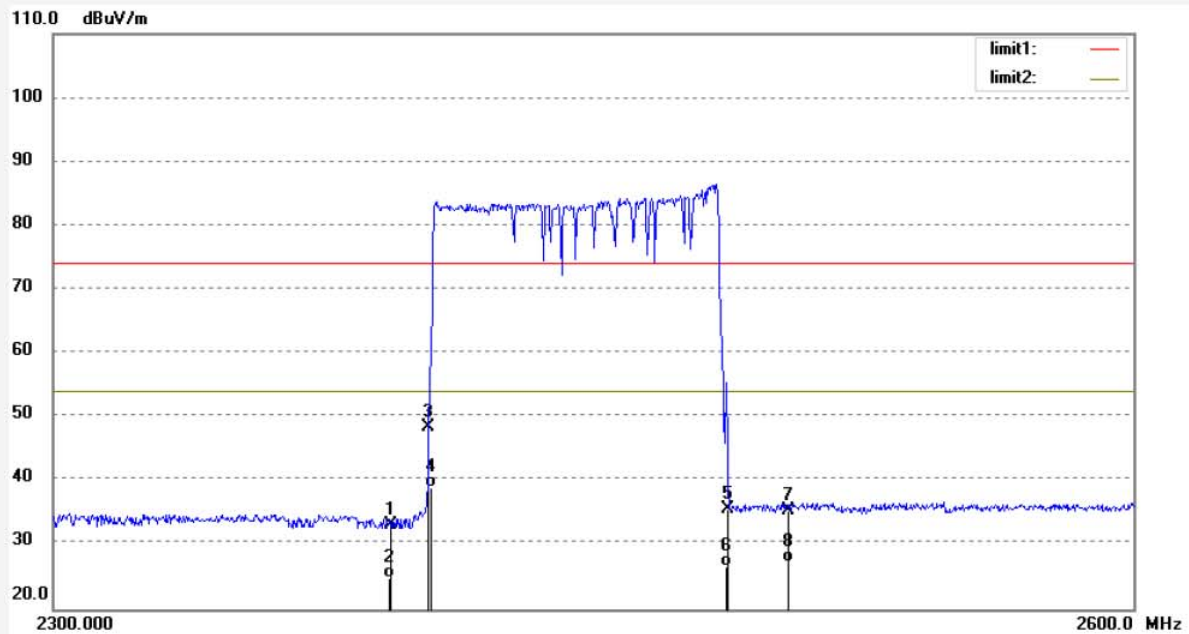

No.	Freq. (MHz)	Reading (dBuV/m)	Factor (dB)	Result (dBuV/m)	Limit (dBuV/m)	Margin (dB)	Detector	Height (cm)	Degree (deg.)	Remark
1	2390.000	39.55	-6.32	33.23	74.00	-40.77	peak	150	302	
2	2390.000	31.15	-6.32	24.83	54.00	-29.17	AVG	150	114	
3	2400.000	54.72	-6.27	48.45	74.00	-25.55	peak	150	92	
4	2400.000	45.32	-6.27	39.05	54.00	-14.95	AVG	150	112	
5	2483.500	41.59	-5.89	35.70	74.00	-38.30	peak	150	230	
6	2483.500	32.45	-5.89	26.56	54.00	-27.44	AVG	150	201	
7	2500.000	41.32	-5.81	35.51	74.00	-38.49	peak	150	41	
8	2500.000	33.16	-5.81	27.35	54.00	-26.65	AVG	150	215	

Note: Average measurement with peak detection at No.2&4&6&8



ACCURATE TECHNOLOGY CO., LTD.

F1,Bldg,A,Changyuan New Material Port Keyuan Rd,
Science & Industry Park,Nanshan Shenzhen,P.R.China

Site: 2# Chamber

Tel:+86-0755-26503290

Fax:+86-0755-26503396

Job No.: FRANK2019-W #457

Standard: FCC PK

Test item: Radiation Test

Temp.(C)/Hum.(%) 25 C / 55 %

EUT: Bluetooth earphone

Mode: HOPPING(GFSK)

Model: BL1

Manufacturer: Dongguan Luxun Electronic Technology Co., Ltd

Polarization: Horizontal

Power Source: DC 3.7V

Date: 2019/11/11

Time: 11:39:13

Engineer Signature:

Distance: 3m

Note: Report NO.:ATE20191613

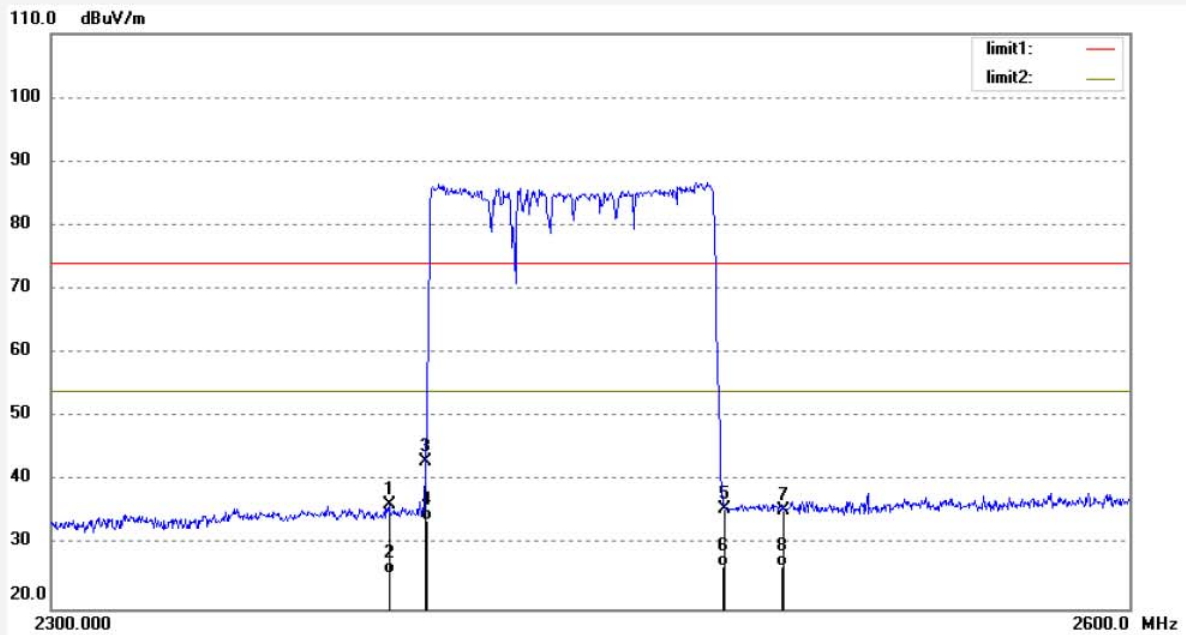

No.	Freq. (MHz)	Reading (dBuV/m)	Factor (dB)	Result (dBuV/m)	Limit (dBuV/m)	Margin (dB)	Detector	Height (cm)	Degree (deg.)	Remark
1	2390.000	42.64	-6.32	36.32	74.00	-37.68	peak	200	302	
2	2390.000	31.75	-6.32	25.43	54.00	-28.57	AVG	200	115	
3	2400.000	49.35	-6.27	43.08	74.00	-30.92	peak	200	193	
4	2400.000	40.13	-6.27	33.86	54.00	-20.14	AVG	200	200	
5	2483.500	41.49	-5.89	35.60	74.00	-38.40	peak	200	102	
6	2483.500	32.48	-5.89	26.59	54.00	-27.41	AVG	200	63	
7	2500.000	41.26	-5.81	35.45	74.00	-38.55	peak	200	301	
8	2500.000	32.45	-5.81	26.64	54.00	-27.36	AVG	200	112	

Note: Average measurement with peak detection at No.2&4&6&8

13.AC POWER LINE CONDUCTED EMISSION TEST

13.1.Block Diagram of Test Setup

13.1.1.Block diagram of connection between the EUT and simulators

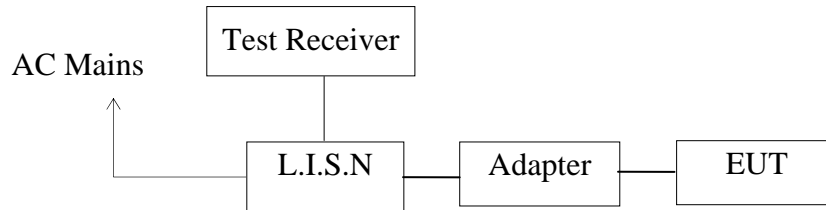

13.1.2.Test System Setup

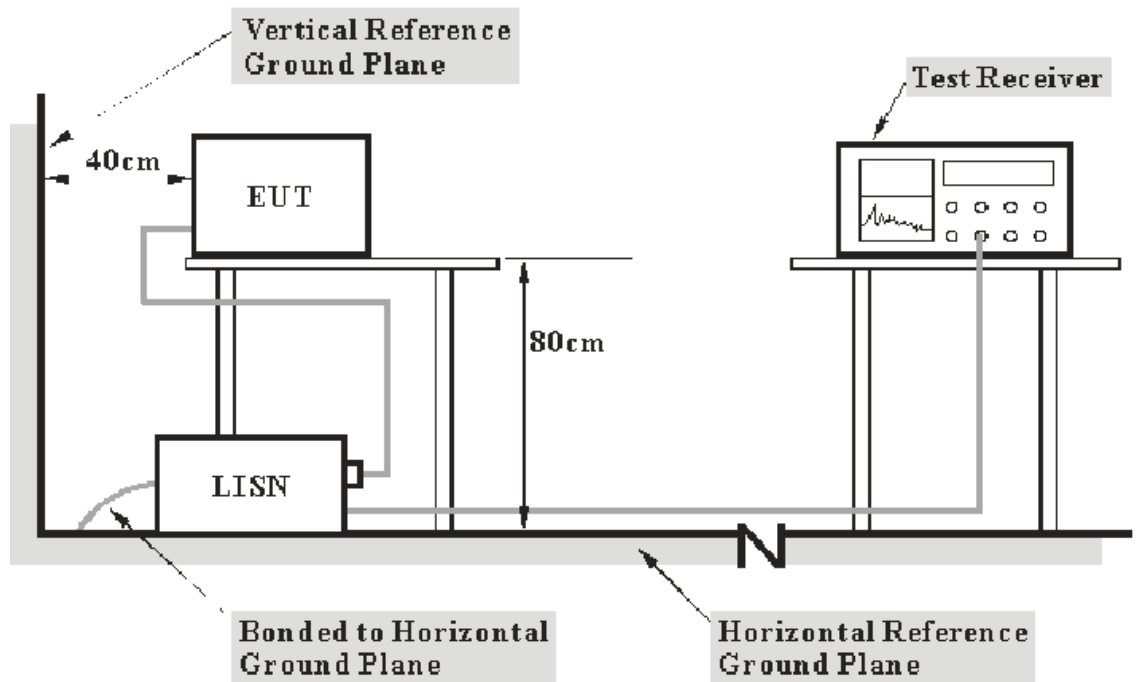

- Note: 1. Support units were connected to second LISN.
2. Both of LISNs (AMN) 80 cm from EUT and at the least 80 cm from other units and other metal planes support units.

13.2. Power Line Conducted Emission Measurement Limits

Frequency (MHz)	Limit dB(μV)	
	Quasi-peak Level	Average Level
0.15 - 0.50	66.0 – 56.0 *	56.0 – 46.0 *
0.50 - 5.00	56.0	46.0
5.00 - 30.00	60.0	50.0

NOTE1: The lower limit shall apply at the transition frequencies.
 NOTE2: The limit decreases linearly with the logarithm of the frequency in the range 0.15MHz to 0.50MHz.

13.3. Configuration of EUT on Measurement

The equipments are installed on Power Line Conducted Emission Measurement to meet the commission requirement and operating regulations in a manner, which tends to maximize its emission characteristics in a normal application.

13.4. Operating Condition of EUT

13.4.1. Setup the EUT and simulator as shown as Section 12.1.

13.4.2. Turn on the power of all equipment.

13.4.3. Let the EUT work in test mode and measure it.

13.5. Test Procedure

The EUT is put on the plane 0.8m high above the ground by insulating support and is connected to the power mains through a line impedance stabilization network (L.I.S.N.). This provides a 50ohm coupling impedance for the EUT system. Please refer the block diagram of the test setup and photographs. Both sides of AC lines are checked to find out the maximum conducted emission. In order to find the maximum emission levels, the relative positions of equipment and all of the interface cables shall be changed according to ANSI C63.10: 2013 on Conducted Emission Measurement.

The bandwidth of test receiver is set at 9kHz.

The frequency range from 150kHz to 30MHz is checked.

13.6.Data Sample

Frequency (MHz)	Transducer value (dB)	QuasiPeak Level (dB μ V)	Average Level (dB μ V)	QuasiPeak Limit (dB μ V)	Average Limit (dB μ V)	QuasiPeak Margin (dB)	Average Margin (dB)	Remark (Pass/Fail)
X.XX	10.6	25.3	17.0	59.0	49.0	33.4	31.7	Pass

Frequency(MHz) = Emission frequency in MHz

Transducer value(dB) = Insertion loss of LISN + Cable Loss

Level(dB μ V) = Quasi-peak Reading/Average Reading + Transducer value

Limit (dB μ V) = Limit stated in standard

Margin = Limit (dB μ V) - Level (dB μ V)

Calculation Formula:

Margin = Limit (dB μ V) - Level (dB μ V)

13.7.Test Results

Pass.

The frequency range from 150kHz to 30MHz is checked.

Maximizing procedure was performed on the six (6) highest emissions of the EUT. Emissions attenuated more than 20 dB below the permissible value are not reported.

All data was recorded in the Quasi-peak and average detection mode.

The spectral diagrams are attached as below.

ACCURATE TECHNOLOGY CO., LTD

CONDUCTED EMISSION STANDARD FCC PART 15B

EUT: Bluetooth earphone M/N:BL1
 Manufacturer: Dongguan Luxun Electronic Technology Co.,Ltd
 Operating Condition: BT Communication
 Test Site: 2#Shielding Room
 Operator: Frank
 Test Specification: L 120V/60Hz
 Comment: Report NO.:ATE20191613
 Start of Test: 2019-11-5 / 16:23:05

SCAN TABLE: "V 150K-30MHZ fin"

Start	Stop	Step	Detector	Meas. Time	IF Bandw.	Transducer
150.0 kHz	30.0 MHz	4.5 kHz	QuasiPeak	1.0 s	9 kHz	NSLK8126 2008
Average						

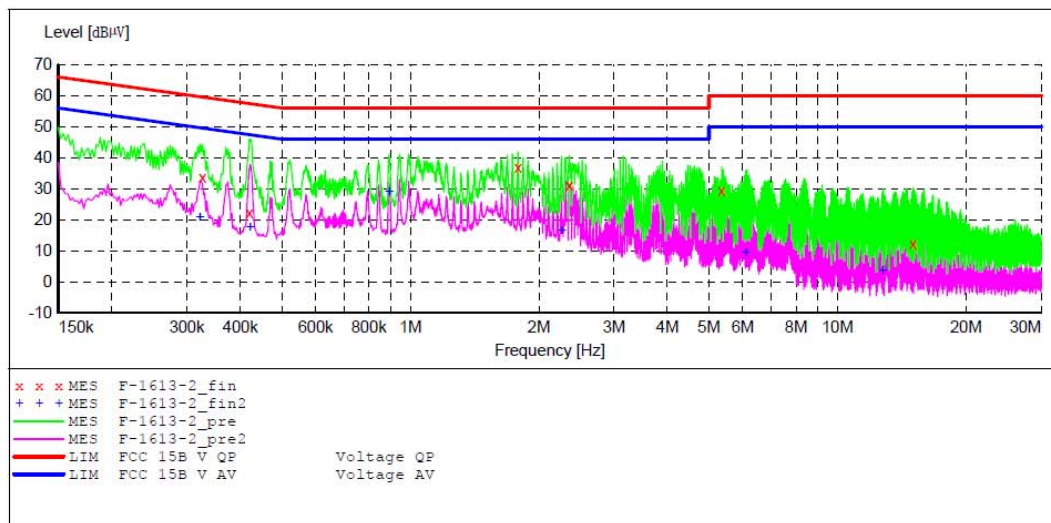

MEASUREMENT RESULT: "F-1613-2_fin"

Frequency MHz	Level dBµV	Transd dB	Limit dBµV	Margin dB	Detector	Line	PE
0.326000	33.70	10.9	60	25.9	QP	L1	GND
0.420000	22.40	11.0	57	35.0	QP	L1	GND
1.786000	36.80	11.2	56	19.2	QP	L1	GND
2.355000	31.20	11.3	56	24.8	QP	L1	GND
5.360000	29.30	11.5	60	30.7	QP	L1	GND
15.020000	12.30	11.6	60	47.7	QP	L1	GND

MEASUREMENT RESULT: "F-1613-2_fin2"

Frequency MHz	Level dBµV	Transd dB	Limit dBµV	Margin dB	Detector	Line	PE
0.322000	20.90	10.9	50	28.8	AV	L1	GND
0.422000	17.70	11.0	47	29.7	AV	L1	GND
0.892000	28.90	11.1	46	17.1	AV	L1	GND
2.260000	16.50	11.3	46	29.5	AV	L1	GND
6.100000	9.50	11.5	50	40.5	AV	L1	GND
12.770000	3.70	11.6	50	46.3	AV	L1	GND

ACCURATE TECHNOLOGY CO.,LTD

CONDUCTED EMISSION STANDARD FCC PART 15B

EUT: Bluetooth earphone M/N:BL1
 Manufacturer: Dongguan Luxun Electronic Technology Co.,Ltd
 Operating Condition: BT Communication
 Test Site: 2#Shielding Room
 Operator: Frank
 Test Specification: N 120V/60Hz
 Comment: Report NO.:ATE20191613
 Start of Test: 2019-11-5 / 16:20:31

SCAN TABLE: "V 150K-30MHz fin"

Start	Stop	Step	Detector	Meas. Time	IF Bandw.	Transducer
150.0 kHz	30.0 MHz	4.5 kHz	QuasiPeak	1.0 s	9 kHz	NSLK8126 2008

Short Description: _SUB_STD_VTERM2 1.70
 Average

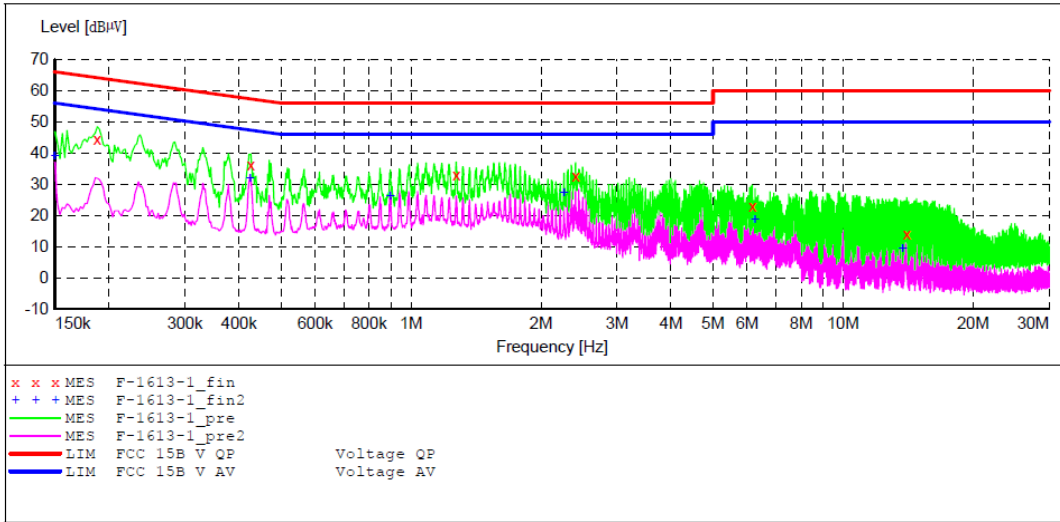

MEASUREMENT RESULT: "F-1613-1_fin"

2019-11-5 16:22

Frequency MHz	Level dBµV	Transd dB	Limit dBµV	Margin dB	Detector	Line	PE
0.188000	44.60	10.8	64	19.5	QP	N	GND
0.426000	36.20	11.0	57	21.1	QP	N	GND
1.272000	33.00	11.2	56	23.0	QP	N	GND
2.405000	32.50	11.3	56	23.5	QP	N	GND
6.165000	22.90	11.5	60	37.1	QP	N	GND
14.045000	14.00	11.6	60	46.0	QP	N	GND

MEASUREMENT RESULT: "F-1613-1_fin2"

2019-11-5 16:22

Frequency MHz	Level dBµV	Transd dB	Limit dBµV	Margin dB	Detector	Line	PE
0.150000	39.10	10.8	56	16.9	AV	N	GND
0.424000	32.00	11.0	47	15.4	AV	N	GND
0.896000	26.10	11.1	46	19.9	AV	N	GND
2.260000	27.30	11.3	46	18.7	AV	N	GND
6.260000	18.70	11.5	50	31.3	AV	N	GND
13.745000	9.50	11.6	50	40.5	AV	N	GND

14. ANTENNA REQUIREMENT

14.1. The Requirement

According to Section 15.203, an intentional radiator shall be designed to ensure that no antenna other than that furnished by the responsible party shall be used with the device.

14.2. Antenna Construction

Device is equipped with permanent attached antenna, which isn't displaced by other antenna. The Max Antenna gain of EUT is 1dBi. Therefore, the equipment complies with the antenna requirement of Section 15.203.

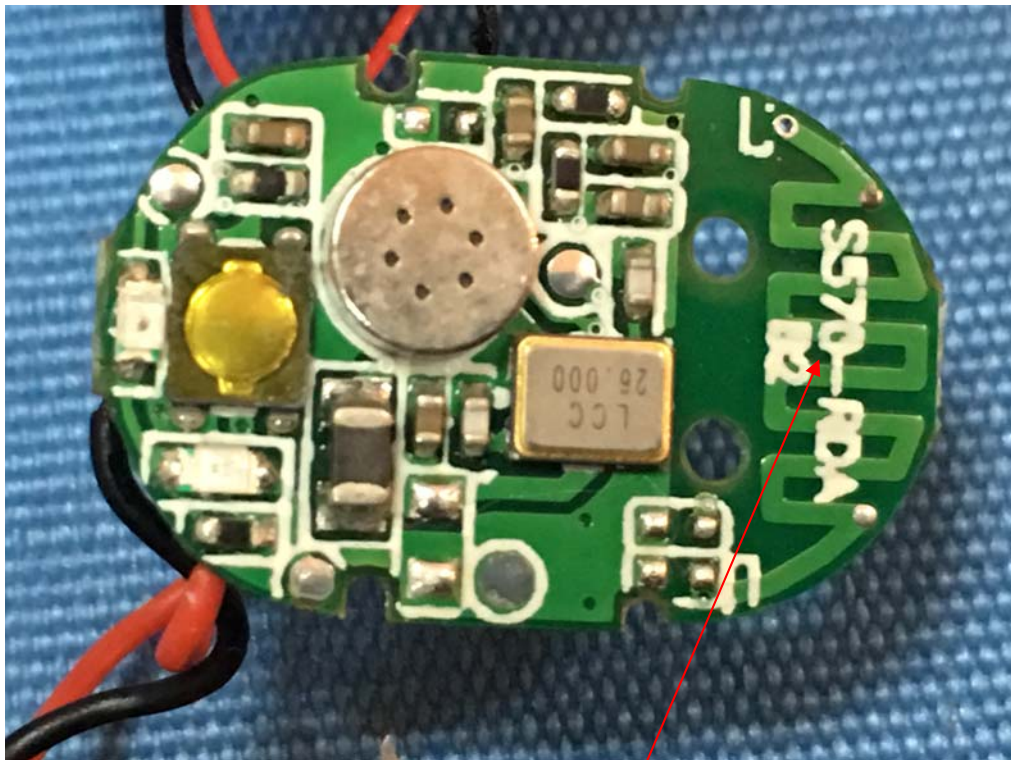

Antenna

***** End of Test Report *****