



RADIO TEST REPORT

Report No.: STS2007302W16

Issued for

Wings Mobile Telecom SL

c/Beethoven 15, piso 4, Barcelona, Spain

Product Name:	Smart Phone
Brand Name:	Wings Mobile
Model Name:	WX
Series Model:	N/A
FCC ID:	2ATQIWX
Test Standard:	FCC Part 15.407

Any reproduction of this document must be done in full. No single part of this document may be reproduced without permission from STS, All Test Data Presented in this report is only applicable to presented Test sample.

Shenzhen STS Test Services Co., Ltd.
A 1/F, Building B, Zhuoke Science Park, No.190 Chongqing Road, HepingShequ,
Fuyong Sub-District, Bao'an District, Shenzhen, Guang Dong, China
TEL: +86-755 3688 6288 FAX: +86-755 3688 6277 E-mail: sts@stsapp.com





TEST RESULT CERTIFICATION

Applicant's Name..... : Wings Mobile Telecom SL
 Address : c/Beethoven 15, piso 4, Barcelona, Spain
Manufacturer's Name..... : COOSEA GROUP (HK) COMPANY LIMITED
 Address : UNIT 5-6 16/F MULTIFIELD PLAZA 3-7A PRAT AVENUE
 TSIMSHATSUI KL

Product Description

Product Name..... : Smart Phone
 Brand Name : Wings Mobile
 Model Name : WX
 Series Model..... : N/A

Test Standards : FCC Part15.407

Test Procedure..... ANSI C63.10-2013

This device described above has been tested by STS, the test results show that the equipment under test (EUT) is in compliance with the FCC requirements. And it is applicable only to the tested sample identified in the report.

This report shall not be reproduced except in full, without the written approval of STS, this document only be altered or revised by STS, personal only, and shall be noted in the revision of the document.

Date of Test :
 Date of receipt of test item : 26 Feb. 2020
 Date (s) of performance of tests : 26 Feb. 2020 ~ 16 Mar. 2020
 Date of Issue..... : 22 July 2020
 Test Result..... : **Pass**

Testing Engineer : *Chris Chen*

(Chris Chen)

Technical Manager : *Sean She*

(Sean she)

Authorized Signatory : *Vita Li*

(Vita Li)

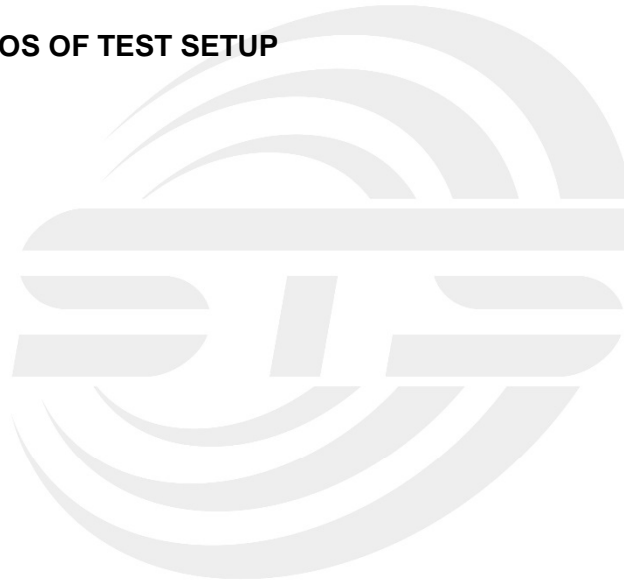



Table of Contents	Page
1 . SUMMARY OF TEST RESULTS	6
1.1 TEST FACTORY	7
1.2 MEASUREMENT UNCERTAINTY	7
2 . GENERAL INFORMATION	8
2.1 GENERAL DESCRIPTION OF THE EUT	8
2.2 DESCRIPTION OF TEST MODES	11
2.3 TEST SOFTWARE AND POWER LEVEL	12
2.4 BLOCK DIGRAM SHOWING THE CONFIGURATION OF SYSTEM TESTED	13
2.5 DESCRIPTION OF NECESSARY ACCESSORIES AND SUPPORT UNITS	14
2.6 EQUIPMENTS LIST FOR ALL TEST ITEMS	15
3 . EMC EMISSION TEST	16
3.1 CONDUCTED EMISSION MEASUREMENT	16
3.2 RADIATED EMISSION AND (BANDEDGE) MEASUREMENT	20
4. CONDUCTED SPURIOUS EMISSIONS AND BANDEDGE	37
4.1 LIMIT	37
4.2 TEST PROCEDURE	37
4.3 DEVIATION FROM STANDARD	37
4.4 TEST SETUP	38
4.5 EUT OPERATION CONDITIONS	38
4.6 TEST RESULTS	38
5. POWER SPECTRAL DENSITY TEST	39
5.1 LIMIT	39
5.2 TEST PROCEDURE	39
5.3 DEVIATION FROM STANDARD	40
5.4 TEST SETUP	40
5.5 EUT OPERATION CONDITIONS	40
5.6 TEST RESULTS	40
6. BANDWIDTH MEASUREMENT	42
6.1 EMISSION BANDWIDTH (EBW) 26 BANDWID PROCEDURES / LIMIT	42
6.2 OCCUPIED BANDWIDTH (99%) TEST APPLIED PROCEDURES / LIMIT	45
6.3 MINIMUM EMISSION BANDWIDTH(6 DB) PROCEDURES / LIMIT	48
7. MAXIMUM CONDUCTED OUTPUT POWER	50
7.1 LIMIT	50
7.2 TEST PROCEDURE	50



Table of Contents	Page
7.3 DEVIATION FROM STANDARD	50
7.4 TEST SETUP	50
7.5 EUT OPERATION CONDITIONS	50
7.6 TEST RESULTS	51
8. AUTOMATICALLY DISCONTINUE TRANSMISSION	65
8.1 LIMIT OF AUTOMATICALLY DISCONTINUE TRANSMISSION	65
8.2 TEST RESULT OF AUTOMATICALLY DISCONTINUE TRANSMISSION	65
9. ANTENNA REQUIREMENT	66
9.1 STANDARD REQUIREMENT	66
9.2 EUT ANTENNA	66
APPENDIX - PHOTOS OF TEST SETUP	67





Revision History

Rev.	Issue Date	Report NO.	Effect Page	Contents
00	16 Mar. 2020	STS2002185W16	ALL	Initial Issue
00	01 Apr. 2020	STS2003175W16	ALL	Updated Model name, Series model, Appearance, Software version number and FCC ID.
00	22 July 2020	STS2007302W16	ALL	Update Brand Name





1. SUMMARY OF TEST RESULTS

Test procedures according to the technical standards:

§ 15.407, KDB 789033 D02 General U-NII Test Procedures New Rules v02r01

FCC Part 15.407		
FCC standard	Test Item	Results
15.207	AC Conducted Emission	PASS
§ 15.407 (2) (26 dB) / § 15.407 (e) (6 dB) / § 15.407 (a) (99%)	26dB/6dB & 99% Bandwidth	PASS
15.407(a) (1).(2).(3).(4).(5)	Maximum Conducted Output Power	PASS
15.407(b) & 15.209	Radiated Emission And (bandedge Emissions) Measurement	PASS
15.407(b)7	Conducted Emission And (bandedge Emissions) Measurement	PASS
15.407(a) (1).(2).(3).(4).(5)	Power Spectral Density	PASS
15.407(c)	Automatically Discontinue Transmission	PASS
15.203/15.204	Antenna Requirement	PASS

NOTE:

- (1) "N/A" denotes test is not applicable in this Test Report.
- (2) All tests are according to ANSI C63.10-2013.



1.1 TEST FACTORY

SHENZHEN STS TEST SERVICES CO., LTD

Add. : A 1/F, Building B, Zhuoke Science Park, No.190 Chongqing Road, HepingShequ, Fuyong Sub-District, Bao'an District, Shenzhen, Guang Dong, China

FCC test Firm Registration Number: 625569

IC test Firm Registration Number: 12108A

A2LA Certificate No.: 4338.01

1.2 MEASUREMENT UNCERTAINTY

The reported uncertainty of measurement $y \pm U$, where expanded uncertainty U is based on a standard uncertainty multiplied by a coverage factor of $k=2$, providing a level of confidence of approximately **95 %**.

No.	Item	Uncertainty
1	RF output power, conducted	$\pm 0.68\text{dB}$
2	Unwanted Emissions, conducted	$\pm 2.988\text{dB}$
3	All emissions, radiated 30-1GHz	$\pm 6.7\text{dB}$
4	All emissions, radiated 1G-6GHz	$\pm 5.5\text{dB}$
5	All emissions, radiated >6G	$\pm 5.8\text{dB}$
6	Conducted Emission (9KHz-150KHz)	$\pm 4.43\text{dB}$
7	Conducted Emission (150KHz-30MHz)	$\pm 5\text{dB}$



2. GENERAL INFORMATION

2.1 GENERAL DESCRIPTION OF THE EUT

Product Name	Smart Phone										
Trade Name	Wings Mobile										
Model Name	WX										
Series Model	N/A										
Model Difference	N/A										
Product Description	The EUT is a Smart Phone										
	<table border="1"> <tr> <td rowspan="4">Operation Frequency:</td> <td>IEEE 802.11a/ n(HT20)/ac(VHT20): 5.180GHz-5.240GHz</td> </tr> <tr> <td>IEEE 802.11n(HT40)/ac(VHT40): 5.190GHz-5.310GHz</td> </tr> <tr> <td>IEEE 802.11ac(VHT80): 5.210GHz</td> </tr> <tr> <td>IEEE 802.11a/ n(HT20)/ac(VHT20): 5.260GHz-5.320GHz</td> </tr> <tr> <td rowspan="2">IEEE 802.11n(HT40)/ac(VHT40): 5.270GHz-5.310GHz</td> <td>IEEE 802.11ac(VHT80): 5.290GHz</td> </tr> <tr> <td>IEEE 802.11a/ n(HT20)/ac(VHT20): 5.745GHz-5.825GHz</td> </tr> <tr> <td rowspan="2">IEEE 802.11n(HT40)/ac(VHT40): 5.755GHz-5.795GHz</td> <td>IEEE 802.11ac(VHT80): 5.775GHz</td> </tr> </table>	Operation Frequency:	IEEE 802.11a/ n(HT20)/ac(VHT20): 5.180GHz-5.240GHz	IEEE 802.11n(HT40)/ac(VHT40): 5.190GHz-5.310GHz	IEEE 802.11ac(VHT80): 5.210GHz	IEEE 802.11a/ n(HT20)/ac(VHT20): 5.260GHz-5.320GHz	IEEE 802.11n(HT40)/ac(VHT40): 5.270GHz-5.310GHz	IEEE 802.11ac(VHT80): 5.290GHz	IEEE 802.11a/ n(HT20)/ac(VHT20): 5.745GHz-5.825GHz	IEEE 802.11n(HT40)/ac(VHT40): 5.755GHz-5.795GHz	IEEE 802.11ac(VHT80): 5.775GHz
	Operation Frequency:		IEEE 802.11a/ n(HT20)/ac(VHT20): 5.180GHz-5.240GHz								
			IEEE 802.11n(HT40)/ac(VHT40): 5.190GHz-5.310GHz								
			IEEE 802.11ac(VHT80): 5.210GHz								
		IEEE 802.11a/ n(HT20)/ac(VHT20): 5.260GHz-5.320GHz									
	IEEE 802.11n(HT40)/ac(VHT40): 5.270GHz-5.310GHz	IEEE 802.11ac(VHT80): 5.290GHz									
IEEE 802.11a/ n(HT20)/ac(VHT20): 5.745GHz-5.825GHz											
IEEE 802.11n(HT40)/ac(VHT40): 5.755GHz-5.795GHz	IEEE 802.11ac(VHT80): 5.775GHz										
	<table border="1"> <tr> <td rowspan="3">Modulation Type:</td> <td>802.11a(OFDM): BPSK,QPSK,16-QAM,64-QAM</td> </tr> <tr> <td>802.11n(OFDM): BPSK,QPSK,16-QAM,64-QAM</td> </tr> <tr> <td>802.11ac(OFDM): BPSK,QPSK,16-QAM,64-QAM,256-QAM</td> </tr> </table>	Modulation Type:	802.11a(OFDM): BPSK,QPSK,16-QAM,64-QAM	802.11n(OFDM): BPSK,QPSK,16-QAM,64-QAM	802.11ac(OFDM): BPSK,QPSK,16-QAM,64-QAM,256-QAM						
Modulation Type:	802.11a(OFDM): BPSK,QPSK,16-QAM,64-QAM										
	802.11n(OFDM): BPSK,QPSK,16-QAM,64-QAM										
	802.11ac(OFDM): BPSK,QPSK,16-QAM,64-QAM,256-QAM										
Antenna Designation:	Please refer to the Note 3.										
Max.Output Power(Conducted):	13.06 dBm										
More details of EUT technical specification, please refer to the User's Manual.											
Test Channel	Please refer to the Note 2.										
Adapter	Input: 100-240V ~ 50/60Hz 0.6A Output: 5V $\overline{\text{---}}$ 2A or 7V $\overline{\text{---}}$ 2A or 9V $\overline{\text{---}}$ 2A or 12V $\overline{\text{---}}$ 1.5A										
Battery	Rated Voltage: DC 3.85V Charge Limit: DC 4.4V Capacity: 3950 mAh										
Hardware version number	K6306W_01										
Software version number	K6307Q4WS-WX.FHDJ.P0.ANASAPA9DATJDFTL.0103_1327.V3.04										
Connecting I/O Port(s)	Please refer to the Note 1.										



1. Note:

For a more detailed features description, please refer to the manufacturer's specifications or the User Manual.

2. Operation Frequency of channel

5.180GHz-5.240GHz		5.745GHz-5.825GHz	
Channel	Frequency	Channel	Frequency
36	5180	149	5745
38	5190	151	5755
40	5200	153	5765
42	5210	157	5785
44	5220	159	5795
46	5230	161	5805
48	5240	165	5825
5.260GHz-5.320GHz			
Channel	Frequency		
52	5260		
54	5270		
56	5280		
58	5290		
60	5300		
62	5310		
64	5320		

Note:

In section 15.31(m), regards to the operating frequency range over 10 MHz, the Lowest frequency, the middle frequency, and the highest frequency of channel were selected to perform the test, and the selected channel see below:

Carrier Frequency Channel

5GHz:

For 802.11a/n(HT20) /ac (VHT20)			
Channel	Freq.(MHz)	Channel	Freq.(MHz)
36	5180	52	5260
40	5200	60	5300
48	5240	64	5320

For 802.11a/n(HT20) /ac (VHT20)			
Channel	Freq.(MHz)	Channel	Freq.(MHz)
149	5745	157	5785
165	5825		

For 802.11n(HT40) /ac (VHT40)			
Channel	Freq.(MHz)	Channel	Freq.(MHz)
38	5190	54	5270
46	5230	62	5310



For 802.11n(HT40) /ac (VHT40)			
Channel	Freq.(MHz)	Channel	Freq.(MHz)
151	5755	159	5795

For 802.11ac (VHT80)			
Channel	Freq.(MHz)	Channel	Freq.(MHz)
42	5210	155	5775

For 802.11ac (VHT80)			
Channel	Freq.(MHz)	Channel	Freq.(MHz)
155	5775		

3.	Ant	Brand	Model Name	Ant Type	Connector	Gain (dBi)	NOTE
	A	Wings Mobile	WX	PIFA	N/A	-1 dBi	WLAN Ant



2.2 DESCRIPTION OF TEST MODES

To investigate the maximum EMI emission characteristics generates from EUT, the test system was pre-scanning tested base on the consideration of following EUT operation mode or test configuration mode which possible have effect on EMI emission level. Each of these EUT operation mode(s) or test configuration mode(s) mentioned above was evaluated respectively.

Worst Mode	Description	Data Rate
Mode 1	TX IEEE 802.11a HT20 CH36&CH40&CH48	6 Mbps
Mode 2	TX IEEE 802.11a HT20 CH52&CH60&CH64	6 Mbps
Mode 3	TX IEEE 802.11a HT20 CH149&CH157&CH165	6 Mbps
Mode 4	TX IEEE 802.11n HT20 CH36&CH40&CH48	MCS 0
Mode 5	TX IEEE 802.11ac HT20 CH36&CH40&CH48	NSS1 MCS0
Mode 6	TX IEEE 802.11n HT20 CH52&CH60&CH64	MCS 0
Mode 7	TX IEEE 802.11ac HT20 CH52&CH60&CH64	NSS1 MCS0
Mode 8	TX IEEE 802.11n HT20 CH149&CH157&CH165	MCS 0
Mode 9	TX IEEE 802.11ac HT20 CH149&CH157&CH165	NSS1 MCS0
Mode 10	TX IEEE 802.11n HT40 CH38&CH46	MCS 0
Mode 11	TX IEEE 802.11ac HT40 CH38&CH46	NSS1 MCS0
Mode 12	TX IEEE 802.11n HT40 CH54 &CH62	MCS 0
Mode 13	TX IEEE 802.11ac HT40 CH54 &CH62	NSS1 MCS0
Mode 14	TX IEEE 802.11n HT40 CH151&CH159	MCS 0
Mode 15	TX IEEE 802.11ac HT40 CH151&CH159	NSS1 MCS0
Mode 16	TX IEEE 802.11ac HT80 CH42	NSS1 MCS0
Mode 17	TX IEEE 802.11ac HT80 CH58	NSS1 MCS0
Mode 18	TX IEEE 802.11ac HT80 CH155	NSS1 MCS0

- Note: (1) The measurements are performed at the highest, middle, lowest available channels.
 (2) The measurements are performed at all Bit Rate of Transmitter, the worst data was reported.
 (3) We have be tested for all availiable U.S. voltage and frequencies(For 120V,50/60Hz and 240V, 50/60Hz) for which the device is capable of operation.

AC Conducted Emission

Test Case	
AC Conducted Emission	Mode 19: Keeping TX + WLAN Link

**2.3 TEST SOFTWARE AND POWER LEVEL**

Describe the test modes available which can facilitate testing:

The EUT can entering Engineering Command by *****#3646633#****

Power Level	
Mode	Power level
Band 1	
802.11 a	17
802.11n(HT20)	17
802.11n(HT40)	15
802.11ac(VHT20)	17
802.11ac(VHT40)	15
802.11ac(VHT80)	12
Band 2	
802.11 a	17
802.11n(HT20)	17
802.11n(HT40)	15
802.11ac(VHT20)	17
802.11ac(VHT40)	15
802.11ac(VHT80)	12
Band 4	
802.11 a	14
802.11n(HT20)	14
802.11n(HT40)	14
802.11ac(VHT20)	14
802.11ac(VHT40)	14
802.11ac(VHT80)	14

2.4 BLOCK DIGRAM SHOWING THE CONFIGURATION OF SYSTEM TESTED

Radiated Spurious Emission Test

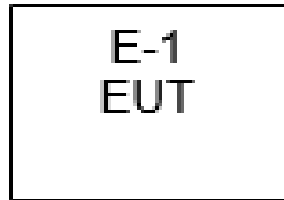

Conducted Emission Test

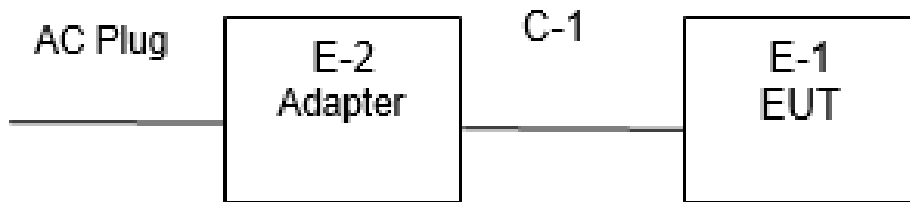



2.5 DESCRIPTION OF NECESSARY ACCESSORIES AND SUPPORT UNITS

The EUT has been tested as an independent unit together with other necessary accessories or support units. The following support units or accessories were used to form a representative test configuration during the tests.

Necessary accessories

Item	Equipment	Mfr/Brand	Model/Type No.	Serial No.	Note
E-2	Adapter	 Wings	HJ-FC017K7-US	N/A	N/A
C-1	DC Cable	N/A	100cm	N/A	N/A

Support units

Item	Equipment	Mfr/Brand	Model/Type No.	Serial No.	Note
N/A	N/A	N/A	N/A	N/A	N/A

Note:

- (1) The support equipment was authorized by Declaration of Confirmation.
- (2) For detachable type I/O cable should be specified the length in cm in 『Length』 column.



2.6 EQUIPMENTS LIST FOR ALL TEST ITEMS

Radiation Test equipment

Kind of Equipment	Manufacturer	Type No.	Serial No.	Last calibration	Calibrated until
EMI Test Receiver	R&S	ESCI	101427	2019.07.29	2020.07.28
Signal Analyzer	Agilent	N9020A	MY51110105	2020.03.05	2021.03.04
Active loop Antenna	ZHINAN	ZN30900C	16035	2018.03.11	2021.03.10
Bilog Antenna	TESEQ	CBL6111D	34678	2017.11.02	2020.11.01
Horn Antenna	SCHWARZBECK	BBHA 9120D(1201)	9120D-1343	2018.10.19	2021.10.18
Horn Antenna (18-40GHz)	A-INFO	LB-180400-KF	J211020657	2018.03.11	2021.03.10
Pre-mpifier (18G-40G)	SKET	LNPA_1840-50	SK2018101801	2019.10.22	2020.10.21
Spectrum Analyzer	R&S	FSV40-N	101823	2019.06.05	2020.06.04
Pre-Amplifier(0.1 M-3GHz)	EM	EM330	060665	2019.10.09	2020.10.08
Pre-Amplifier (1G-18GHz)	SKET	LNPA-01018G-4 5	SK2018080901	2019.10.12	2020.10.11
Temperature & Humidity	HH660	Mieo	N/A	2019.10.12	2020.10.11
Trn table	EM	SC100_1	60531	N/A	N/A
Antenna mast	EM	SC100	N/A	N/A	N/A
Test SW	BULUN	BL410-E/18.905			

Conduction Test equipment

Kind of Equipment	Manufacturer	Type No.	Serial No.	Last calibration	Calibrated until
Test Receiver	R&S	ESCI	101427	2019.07.29	2020.07.28
LISN	R&S	ENV216	101242	2019.10.09	2020.10.08
LISN	EMCO	3810/2NM	23625	2019.10.09	2020.10.08
Temperature & Humidity	HH660	Mieo	N/A	2019.10.12	2020.10.11
Test SW	FARAD	EZ-EMC(Ver.STSLAB-03A1 CE)			

RF Connected Test

Kind of Equipment	Manufacturer	Type No.	Serial No.	Last calibration	Calibrated until
USB RF power sensor	DARE	RPR3006W	15I00041SNO03	2019.10.09	2020.10.08
Signal Analyzer	Agilent	N9020A	MY49100060	2019.10.09	2020.10.08
Temperature & Humidity	HH660	Mieo	N/A	2019.10.12	2020.10.11
Test SW	FARAD	LZ-RF /LzRf-3A3			



3. EMC EMISSION TEST

3.1 CONDUCTED EMISSION MEASUREMENT

3.1.1 POWER LINE CONDUCTED EMISSION Limits (Frequency Range 150KHz-30MHz)

FREQUENCY (MHz)	Class B (dBuV)		Standard
	Quasi-peak	Average	
0.15 -0.5	66 - 56 *	56 - 46 *	CISPR
0.50 -5.0	56.00	46.00	CISPR
5.0 -30.0	60.00	50.00	CISPR

0.15 -0.5	66 - 56 *	56 - 46 *	FCC
0.50 -5.0	56.00	46.00	FCC
5.0 -30.0	60.00	50.00	FCC

Note:

- (1) The tighter limit applies at the band edges.
- (2) The limit of " * " marked band means the limitation decreases linearly with the logarithm of the frequency in the range.

The following table is the setting of the receiver

Receiver Parameters	Setting
Attenuation	10 dB
Start Frequency	0.15 MHz
Stop Frequency	30 MHz
IF Bandwidth	9 kHz

3.1.2 TEST PROCEDURE

- a. The EUT was placed 0.8 meters from the horizontal ground plane with EUT being connected to the power mains through a line impedance stabilization network (LISN). All other support equipments powered from additional LISN(s). The LISN provide 50 Ohm/ 50uH of coupling impedance for the measuring instrument.
- b. Interconnecting cables that hang closer than 40 cm to the ground plane shall be folded back and forth in the center forming a bundle 30 to 40 cm long.
- c. I/O cables that are not connected to a peripheral shall be bundled in the center. The end of the cable may be terminated, if required, using the correct terminating impedance. The overall length shall not exceed 1 m.
- d. LISN at least 80 cm from nearest part of EUT chassis.
- e. For the actual test configuration, please refer to the related Item –EUT Test Photos.

3.1.3 DEVIATION FROM TEST STANDARD

No deviation

3.1.4 TEST SETUP

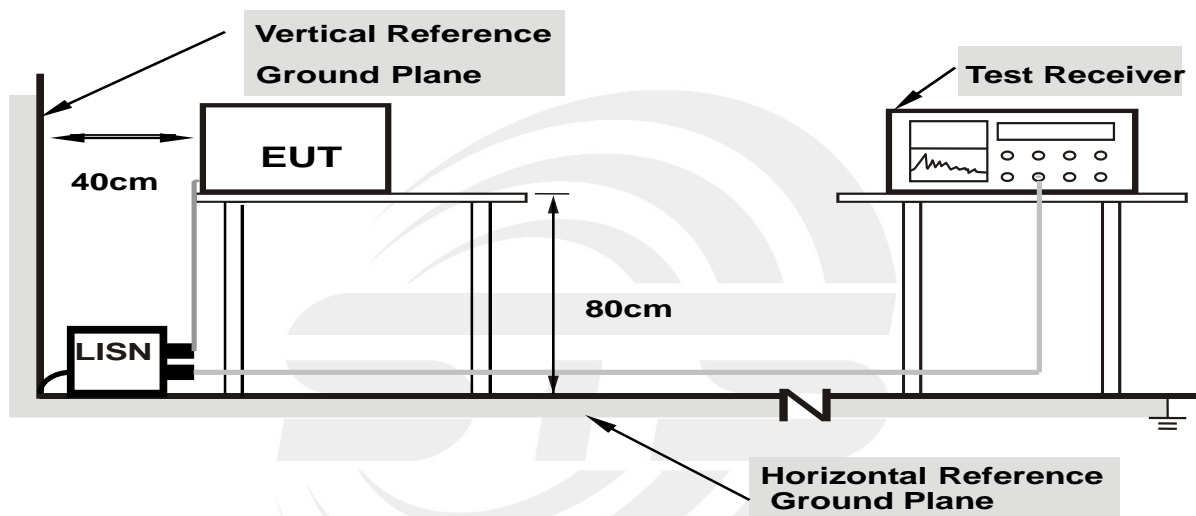

Note: 1.Support units were connected to second LISN.

2.Both of LISNs (AMN) are 80 cm from EUT and at least 80 from other units and other metal planes

3.1.5 EUT OPERATING CONDITIONS

The EUT was configured for testing in a typical fashion (as a customer would normally use it). The EUT has been programmed to continuously transmit during test. This operating condition was tested and used to collect the included data.



3.1.6 TEST RESULTS

Temperature:	23.4(C)	Relative Humidity:	49%RH
Test Voltage:	AC 120V/60Hz	Phase:	L
Test Mode :	Mode 19		

No.	Frequency (MHz)	Reading (dBuV)	Correct Factor(dB)	Result (dBuV)	Limit (dBuV)	Margin (dB)	Remark
1	0.1580	33.31	19.79	53.10	65.57	-12.47	QP
2	0.1580	14.55	19.79	34.34	55.57	-21.23	AVG
3	0.5500	24.88	19.98	44.86	56.00	-11.14	QP
4	0.5500	19.39	19.98	39.37	46.00	-6.63	AVG
5	1.5380	17.69	19.79	37.48	56.00	-18.52	QP
6	1.5380	9.32	19.79	29.11	46.00	-16.89	AVG
7	5.0900	16.10	19.85	35.95	60.00	-24.05	QP
8	5.0900	4.78	19.85	24.63	50.00	-25.37	AVG
9	8.2260	21.65	20.02	41.67	60.00	-18.33	QP
10	8.2260	8.62	20.02	28.64	50.00	-21.36	AVG
11	10.4660	22.22	20.21	42.43	60.00	-17.57	QP
12	10.4660	8.34	20.21	28.55	50.00	-21.45	AVG

Remark:

1. All readings are Quasi-Peak and Average values.
2. Margin = Result (Result =Reading + Factor)–Limit

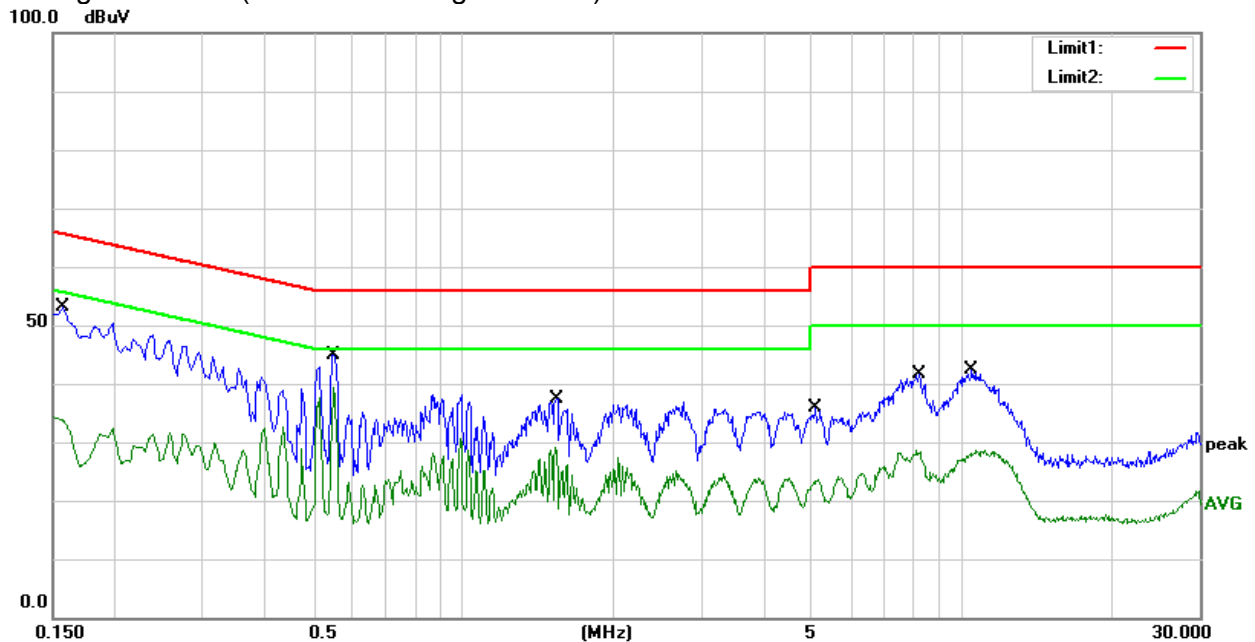



Temperature:	23.4(C)	Relative Humidity:	49%RH
Test Voltage	AC 120V/60Hz	Phase:	N
Test Mode	Mode 19		

No.	Frequency (MHz)	Reading (dBuV)	Correct Factor(dB)	Result (dBuV)	Limit (dBuV)	Margin (dB)	Remark
1	0.1580	31.96	19.79	51.75	65.57	-13.82	QP
2	0.1580	13.16	19.79	32.95	55.57	-22.62	AVG
3	0.2380	28.08	19.95	48.03	62.17	-14.14	QP
4	0.2380	9.20	19.95	29.15	52.17	-23.02	AVG
5	0.5500	19.81	19.98	39.79	56.00	-16.21	QP
6	0.5500	1.67	19.98	21.65	46.00	-24.35	AVG
7	1.5300	11.22	19.79	31.01	56.00	-24.99	QP
8	1.5300	2.16	19.79	21.95	46.00	-24.05	AVG
9	7.7380	21.15	19.97	41.12	60.00	-18.88	QP
10	7.7380	4.35	19.97	24.32	50.00	-25.68	AVG
11	10.7260	21.19	20.22	41.41	60.00	-18.59	QP
12	10.7260	4.82	20.22	25.04	50.00	-24.96	AVG

Remark:

1. All readings are Quasi-Peak and Average values.
2. Margin = Result (Result = Reading + Factor) - Limit

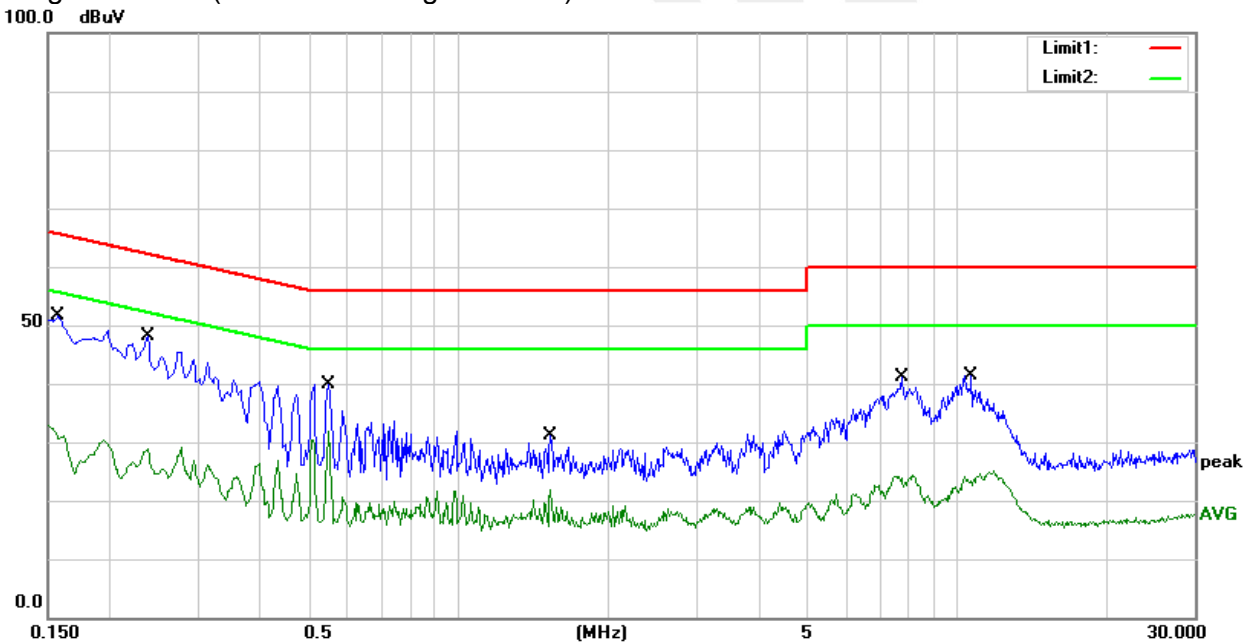

3.2 RADIATED EMISSION AND (BANDEDGE) MEASUREMENT

3.2.1 RADIATED EMISSION LIMITS (Frequency Range 9kHz-1000MHz)

In case the emission fall within the restricted band specified on 15.407(b)7& 15.205/209(a), then the (a); limit in the table below has to be followed.

Frequencies (MHz)	Field Strength (microvolts/meter)	Measurement Distance (meters)
0.009~0.490	2400/F(KHz)	300
0.490~1.705	24000/F(KHz)	30
1.705~30.0	30	30
30~88	100	3
88~216	150	3
216~960	200	3
Above 960	500	3

LIMITS OF RADIATED EMISSION MEASUREMENT (Above 1000MHz)

FREQUENCY (MHz)	Class B (dBuV/m) (at 3M)	
	PEAK	AVERAGE
Above 1000	68.2	54

Notes:

- (1) The limit for radiated test was performed according to FCC PART 15E.
- (2) The tighter limit applies at the band edges.
- (3) Emission level (dBuV/m)=20log Emission level (uV/m).

Spectrum Parameter	Setting
Attenuation	Auto
Detector	Peak
Start Frequency	1000 MHz(Peak/AV)
Stop Frequency	10th carrier harmonic(Peak/AV)
RB / VB (emission in restricted band)	1 MHz / 1 MHz, AV=1 MHz /3 MHz

For Band edge

Spectrum Parameter	Setting
Detector	Peak
RB / VB (emission in restricted band)	1 MHz / 1 MHz, AV=1 MHz /3 MHz



Receiver Parameter	Setting
Attenuation	Auto
Start ~ Stop Frequency	9kHz~90kHz / RB 200Hz for PK & AV
Start ~ Stop Frequency	90kHz~110kHz / RB 200Hz for QP
Start ~ Stop Frequency	110kHz~490kHz / RB 200Hz for PK & AV
Start ~ Stop Frequency	490kHz~30MHz / RB 9kHz for QP
Start ~ Stop Frequency	30MHz~1000MHz / RB 120kHz for QP

3.2.2 TEST PROCEDURE

- The measuring distance of at 3 m shall be used for measurements at frequency 0.009MHz up to 1GHz. For frequencies above 1GHz, any suitable measuring distance may be used.
- The EUT was placed on the top of a rotating table 0.8 meters(above 1GHz is 1.5 m) above the ground at a 3 meter anechoic chamber. The table was rotated 360 degrees to determine the position of the highest radiation.
- The height of the equipment shall be 0.8 m(above 1GHz is 1.5 m); the height of the test antenna shall vary between 1 m to 4 m. Horizontal and vertical polarizations of the antenna are set to make the measurement
- The initial step in collecting conducted emission data is a spectrum analyzer peak detector mode pre-scanning the measurement frequency range. Significant peaks are then marked and then Quasi Peak detector mode re-measured.
- If the Peak Mode measured value compliance with and lower than Quasi Peak Mode Limit, the EUT shall be deemed to meet QP Limits and then no additional QP Mode measurement performed.
- For the actual test configuration, please refer to the related Item –EUT Test Photos.

Note:

Both horizontal and vertical antenna polarities were tested and performed test to three orthogonal axis. The worst case emissions were reported

3.2.2 DEVIATION FROM TEST STANDARD

No deviation

3.2.3 TEST SETUP

(A) Radiated Emission Test-Up Frequency Below 30MHz

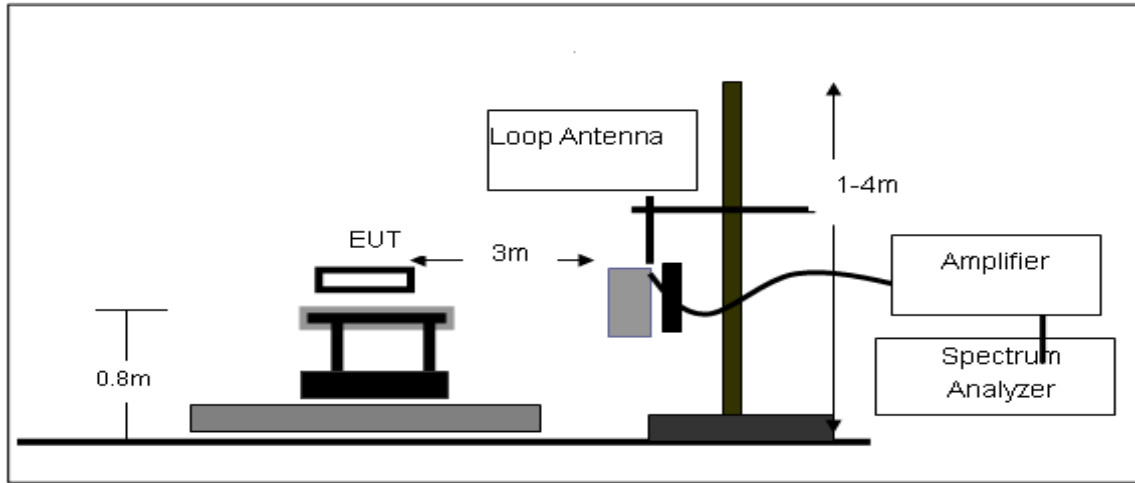

(B) Radiated Emission Test-Up Frequency 30MHz~1GHz

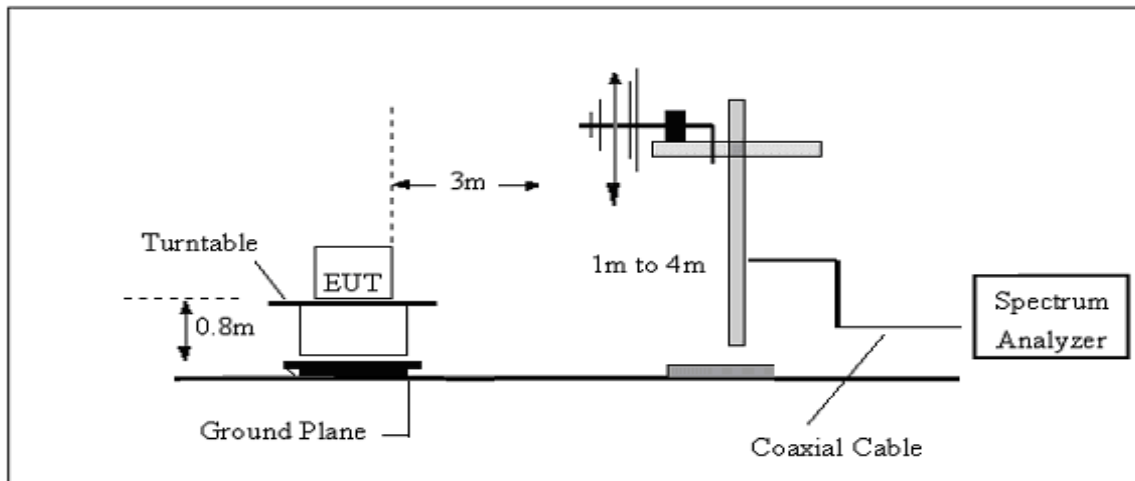

(C) Radiated Emission Test-Up Frequency Above 1GHz

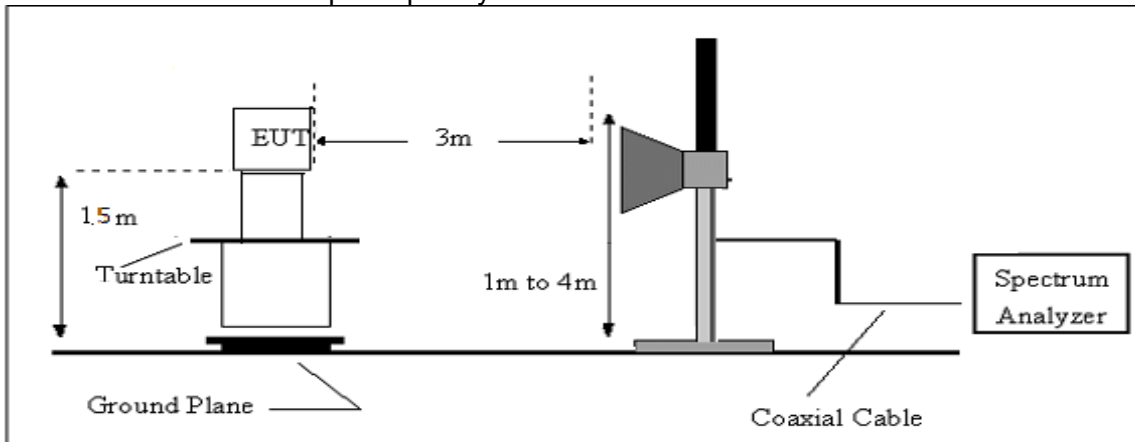



3.2.4 EUT OPERATING CONDITIONS

The EUT tested system was configured as the statements of 2.4 Unless otherwise a special operating condition is specified in the follows during the testing.

3.2.5 FIELD STRENGTH CALCULATION

The field strength is calculated by adding the Antenna Factor and Cable Factor and subtracting the Amplifier Gain and Duty Cycle Correction Factor (if any) from the measured reading. The basic equation with a sample calculation is as follows:

$$FS = RA + AF + CL - AG$$

Where

FS = Field Strength

CL = Cable Attenuation Factor (Cable Loss)

RA = Reading Amplitude

AG = Amplifier Gain

AF = Antenna Factor

For example

Frequency (MHz)	FS (dB μ V/m)	RA (dB μ V/m)	AF (dB)	CL (dB)	AG (dB)	Factor (dB)
300	40	58.1	12.2	1.6	31.9	-18.1

$$\text{Factor} = \text{AF} + \text{CL} - \text{AG}$$

**3.2.6 TEST RESULTS (Between 9KHz – 30 MHz)**

Temperature:	23.4(C)	Relative Humidity:	49%RH
Test Voltage :	DC 3.85V	Polarization :	--
Test Mode :	TX Mode		

Freq.	Reading	Limit	Margin	State
(MHz)	(dBuV/m)	(dBuV/m)	(dB)	P/F
--	--	--	--	PASS
--	--	--	--	PASS

Note:

The amplitude of spurious emissions which are attenuated by more than 20dB below the permissible value has no need to be reported.

Distance extrapolation factor = $40 \log(\text{specific distance}/\text{test distance})$ (dB);

Limit line = specific limits(dBuv) + distance extrapolation factor.

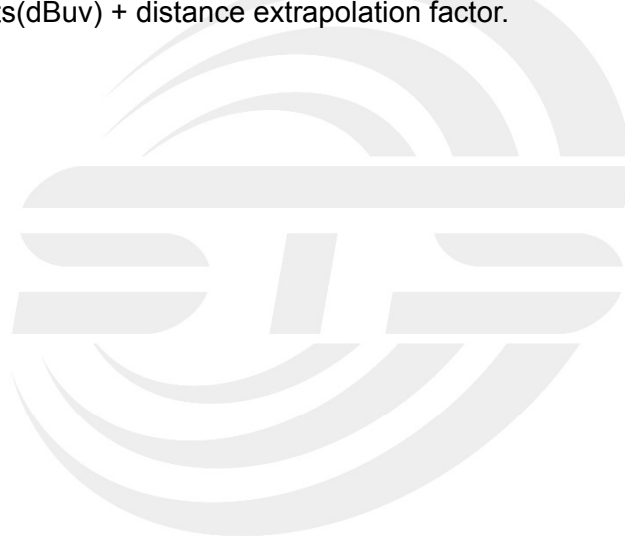



3.2.7 TEST RESULTS (Between 30MHz – 1GHz)

Temperature	23.4(C)	Relative Humidity:	49%RH
Test Voltage	DC 3.85V	Polarization:	Horizontal
Test Mode	Mode 1~18(Mode 6 worst mode)		

No.	Frequency (MHz)	Reading (dBuV)	Correct Factor(dB/m)	Result (dBuV/m)	Limit (dBuV/m)	Margin (dB)	Remark
1	30.9700	29.47	-13.35	16.12	40.00	-23.88	QP
2	261.8300	30.83	-14.77	16.06	46.00	-29.94	QP
3	469.4100	32.61	-9.03	23.58	46.00	-22.42	QP
4	608.1200	30.13	-5.56	24.57	46.00	-21.43	QP
5	733.2500	30.80	-2.35	28.45	46.00	-17.55	QP
6	936.9500	30.25	1.13	31.38	46.00	-14.62	QP

Remark:

1. Margin = Result (Result =Reading + Factor)–Limit

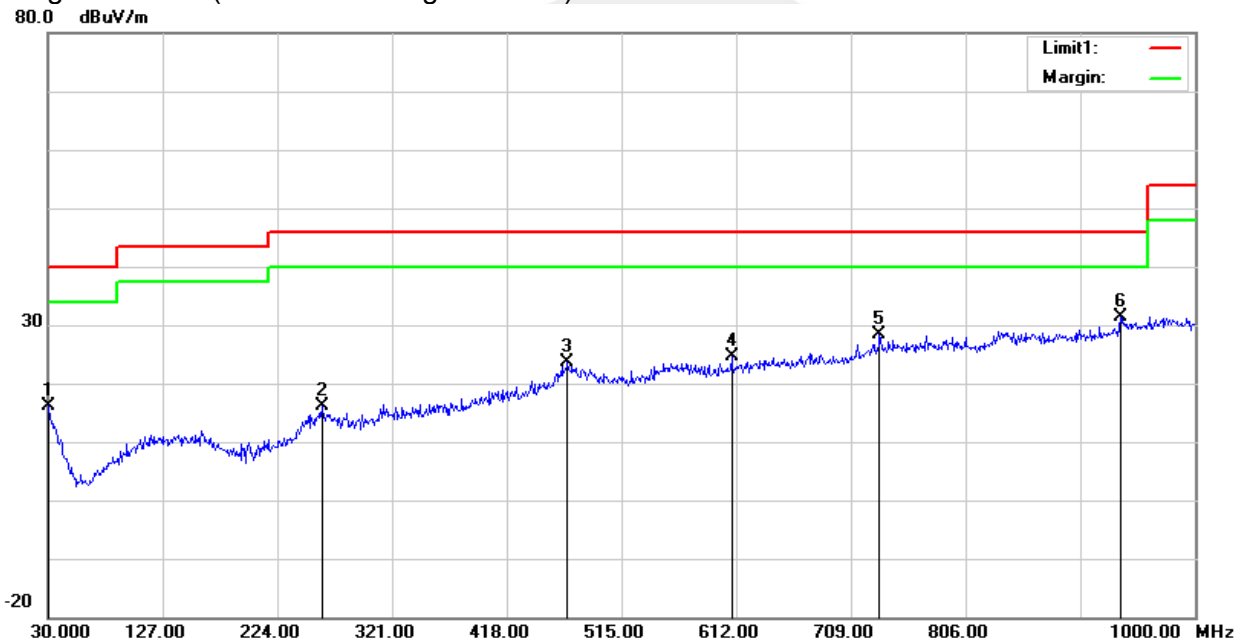



Temperature	23.4(C)	Relative Humidity:	49%RH
Test Voltage	DC 3.85V	Polarization:	Vertical
Test Mode	Mode 1~18(Mode 6 worst mode)		

No.	Frequency (MHz)	Reading (dBuV)	Correct Factor(dB/m)	Result (dBuV/m)	Limit (dBuV/m)	Margin (dB)	Remark
1	30.9700	29.21	-13.35	15.86	40.00	-24.14	QP
2	260.8600	29.48	-14.78	14.70	46.00	-31.30	QP
3	440.3100	30.04	-10.08	19.96	46.00	-26.04	QP
4	628.4900	28.63	-5.11	23.52	46.00	-22.48	QP
5	733.2500	30.58	-2.35	28.23	46.00	-17.77	QP
6	960.2300	30.11	1.76	31.87	54.00	-22.13	QP

Remark:

1. Margin = Result (Result =Reading + Factor)-Limit

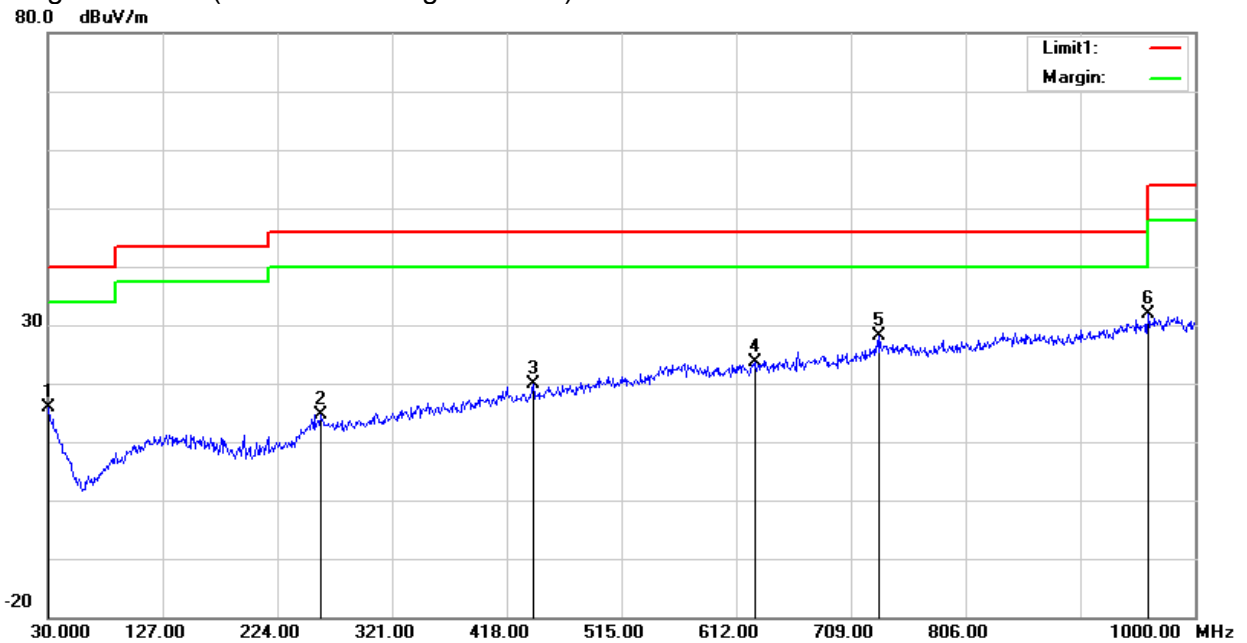



3.2.8 TEST RESULTS (Above 1000 MHz)

Band I 5150-5250MHz

Frequency (MHz)	Reading (dBuV)	Amplifier (dB)	Loss (dB)	Antenna Factor (dB/m)	Orrected Factor (dB)	Emission Level (dBµV/m)	Limit (dBuV/m)	Margin (dB)	Detector	Comment
Low Channel (802.11n (HT-20)/ 5180 MHz)										
3263.42	44.24	44.70	6.70	28.20	-9.80	34.44	68.20	-33.76	Pk	Vertical
3263.42	41.91	44.70	6.70	28.20	-9.80	32.11	54.00	-21.89	AV	Vertical
3259.56	44.29	44.70	6.70	28.20	-9.80	34.49	68.20	-33.71	Pk	Horizontal
3259.56	41.87	44.70	6.70	28.20	-9.80	32.07	54.00	-21.93	AV	Horizontal
3987.93	39.50	44.20	7.90	29.70	-6.60	32.90	68.20	-35.30	Pk	Vertical
3987.93	36.69	44.20	7.90	29.70	-6.60	30.09	54.00	-23.91	AV	Vertical
3996.52	38.65	44.20	7.90	29.70	-6.60	32.05	68.20	-36.15	Pk	Horizontal
3996.52	36.23	44.20	7.90	29.70	-6.60	29.63	54.00	-24.37	AV	Horizontal
7221.30	36.99	43.50	11.40	35.50	3.40	40.39	68.20	-27.81	Pk	Vertical
7221.30	34.66	43.50	11.40	35.50	3.40	38.06	54.00	-15.94	AV	Vertical
7216.86	37.26	43.50	11.40	35.50	3.40	40.66	68.20	-27.54	Pk	Horizontal
7216.86	34.52	43.50	11.40	35.50	3.40	37.92	54.00	-16.08	AV	Horizontal
10360.29	40.02	44.50	13.80	38.80	8.10	48.12	68.20	-20.08	Pk	Vertical
10360.29	37.04	44.50	13.80	38.80	8.10	45.14	54.00	-8.86	AV	Vertical
10359.95	39.47	44.50	13.80	38.80	8.10	47.57	68.20	-20.63	Pk	Horizontal
10359.95	35.77	44.50	13.80	38.80	8.10	43.87	54.00	-10.13	AV	Horizontal
11025.80	33.11	43.60	14.30	39.50	10.20	43.31	68.20	-24.89	Pk	Vertical
11025.80	30.30	43.60	14.30	39.50	10.20	40.50	54.00	-13.50	AV	Vertical
11033.73	33.78	43.60	14.30	39.50	10.20	43.98	68.20	-24.22	Pk	Horizontal
11033.73	29.99	43.60	14.30	39.50	10.20	40.19	54.00	-13.81	AV	Horizontal
13283.30	33.00	42.60	15.90	38.90	12.20	45.20	68.20	-23.00	Pk	Vertical
13283.30	29.37	42.60	15.90	38.90	12.20	41.57	54.00	-12.43	AV	Vertical
13286.11	32.24	42.60	15.90	38.90	12.20	44.44	68.20	-23.76	Pk	Horizontal
13286.11	29.87	42.60	15.90	38.90	12.20	42.07	54.00	-11.93	AV	Horizontal
Mid Channel (802.11n (HT-20)/ 5200 MHz)										
3245.61	44.78	44.70	6.70	28.20	-9.80	34.98	68.20	-33.22	Pk	Vertical
3245.61	41.09	44.70	6.70	28.20	-9.80	31.29	54.00	-22.71	AV	Vertical
3248.23	44.76	44.70	6.70	28.20	-9.80	34.96	68.20	-33.24	Pk	Horizontal
3248.23	41.67	44.70	6.70	28.20	-9.80	31.87	54.00	-22.13	AV	Horizontal
3998.61	39.89	44.20	7.90	29.70	-6.60	33.29	68.20	-34.91	Pk	Vertical
3998.61	36.14	44.20	7.90	29.70	-6.60	29.54	54.00	-24.46	AV	Vertical
3987.25	39.07	44.20	7.90	29.70	-6.60	32.47	68.20	-35.73	Pk	Horizontal
3987.25	36.87	44.20	7.90	29.70	-6.60	30.27	54.00	-23.73	AV	Horizontal
7225.42	36.51	43.50	11.40	35.50	3.40	39.91	68.20	-28.29	Pk	Vertical
7225.42	34.40	43.50	11.40	35.50	3.40	37.80	54.00	-16.20	AV	Vertical
7222.02	36.90	43.50	11.40	35.50	3.40	40.30	68.20	-27.90	Pk	Horizontal
7222.02	34.09	43.50	11.40	35.50	3.40	37.49	54.00	-16.51	AV	Horizontal
10400.41	39.44	44.50	13.80	38.80	8.10	47.54	68.20	-20.66	Pk	Vertical
10400.41	35.98	44.50	13.80	38.80	8.10	44.08	54.00	-9.92	AV	Vertical
10400.43	39.61	44.50	13.80	38.80	8.10	47.71	68.20	-20.49	Pk	Horizontal
10400.43	36.86	44.50	13.80	38.80	8.10	44.96	54.00	-9.04	AV	Horizontal
11022.25	33.23	43.60	14.30	39.50	10.20	43.43	68.20	-24.77	Pk	Vertical
11022.25	30.82	43.60	14.30	39.50	10.20	41.02	54.00	-12.98	AV	Vertical
11026.21	33.78	43.60	14.30	39.50	10.20	43.98	68.20	-24.22	Pk	Horizontal
11026.21	29.70	43.60	14.30	39.50	10.20	39.90	54.00	-14.10	AV	Horizontal
13281.39	31.72	42.60	15.90	38.90	12.20	43.92	68.20	-24.28	Pk	Vertical
13281.39	29.21	42.60	15.90	38.90	12.20	41.41	54.00	-12.59	AV	Vertical
13288.82	31.75	42.60	15.90	38.90	12.20	43.95	68.20	-24.25	Pk	Horizontal
13288.82	29.92	42.60	15.90	38.90	12.20	42.12	54.00	-11.88	AV	Horizontal



High Channel (802.11n (HT-20)/ 5240 MHz)										
3252.81	44.16	44.70	6.70	28.20	-9.80	34.36	68.20	-33.84	Pk	Vertical
3252.81	40.86	44.70	6.70	28.20	-9.80	31.06	54.00	-22.94	AV	Vertical
3248.70	44.56	44.70	6.70	28.20	-9.80	34.76	68.20	-33.44	Pk	Horizontal
3248.70	41.75	44.70	6.70	28.20	-9.80	31.95	54.00	-22.05	AV	Horizontal
3999.07	39.42	44.20	7.90	29.70	-6.60	32.82	68.20	-35.38	Pk	Vertical
3999.07	36.67	44.20	7.90	29.70	-6.60	30.07	54.00	-23.93	AV	Vertical
3980.71	38.94	44.20	7.90	29.70	-6.60	32.34	68.20	-35.86	Pk	Horizontal
3980.71	36.59	44.20	7.90	29.70	-6.60	29.99	54.00	-24.01	AV	Horizontal
7225.12	36.63	43.50	11.40	35.50	3.40	40.03	68.20	-28.17	Pk	Vertical
7225.12	33.76	43.50	11.40	35.50	3.40	37.16	54.00	-16.84	AV	Vertical
7227.26	37.41	43.50	11.40	35.50	3.40	40.81	68.20	-27.39	Pk	Horizontal
7227.26	34.02	43.50	11.40	35.50	3.40	37.42	54.00	-16.58	AV	Horizontal
10480.20	38.74	44.50	13.80	38.80	8.10	46.84	68.20	-21.36	Pk	Vertical
10480.20	36.80	44.50	13.80	38.80	8.10	44.90	54.00	-9.10	AV	Vertical
10480.20	39.57	44.50	13.80	38.80	8.10	47.67	68.20	-20.53	Pk	Horizontal
10480.20	36.97	44.50	13.80	38.80	8.10	45.07	54.00	-8.93	AV	Horizontal
11033.00	33.79	43.60	14.30	39.50	10.20	43.99	68.20	-24.21	Pk	Vertical
11033.00	30.94	43.60	14.30	39.50	10.20	41.14	54.00	-12.86	AV	Vertical
11025.16	32.91	43.60	14.30	39.50	10.20	43.11	68.20	-25.09	Pk	Horizontal
11025.16	30.01	43.60	14.30	39.50	10.20	40.21	54.00	-13.79	AV	Horizontal
13293.39	32.04	42.60	15.90	38.90	12.20	44.24	68.20	-23.96	Pk	Vertical
13293.39	30.01	42.60	15.90	38.90	12.20	42.21	54.00	-11.79	AV	Vertical
13284.89	32.70	42.60	15.90	38.90	12.20	44.90	68.20	-23.30	Pk	Horizontal
13284.89	29.29	42.60	15.90	38.90	12.20	41.49	54.00	-12.51	AV	Horizontal

Remark:

- Factor = Antenna Factor + Cable Loss – Pre-amplifier.
- Scan with 802.11a,802.11n (HT-20),802.11n (HT-40), 802.11ac (VHT-20),802.11ac (VHT-40), 802.11ac (VHT-80) the worst case is 802.11n (HT-20).
- The frequency emission of peak points that did not show above the forms are at least 20dB below the limit, the frequency emission is mainly from the environment noise.



Band II 5250-5350MHz

Frequency (MHz)	Reading (dBuV)	Amplifier (dB)	Loss (dB)	Antenna Factor (dB/m)	Orrected Factor (dB)	Emission Level (dBuV/m)	Limit (dBuV/m)	Margin (dB)	Detector	Comment
Low Channel (802.11n (HT-20)/ 5260 MHz)										
3257.68	44.26	44.70	6.70	28.20	-9.80	34.46	68.20	-33.74	Pk	Vertical
3257.68	41.60	44.70	6.70	28.20	-9.80	31.80	54.00	-22.20	AV	Vertical
3258.80	44.75	44.70	6.70	28.20	-9.80	34.95	68.20	-33.25	Pk	Horizontal
3258.80	41.25	44.70	6.70	28.20	-9.80	31.45	54.00	-22.55	AV	Horizontal
3997.54	39.63	44.20	7.90	29.70	-6.60	33.03	68.20	-35.17	Pk	Vertical
3997.54	35.89	44.20	7.90	29.70	-6.60	29.29	54.00	-24.71	AV	Vertical
3980.56	39.51	44.20	7.90	29.70	-6.60	32.91	68.20	-35.29	Pk	Horizontal
3980.56	36.95	44.20	7.90	29.70	-6.60	30.35	54.00	-23.65	AV	Horizontal
7234.80	37.67	43.50	11.40	35.50	3.40	41.07	68.20	-27.13	Pk	Vertical
7234.80	33.93	43.50	11.40	35.50	3.40	37.33	54.00	-16.67	AV	Vertical
7231.22	36.47	43.50	11.40	35.50	3.40	39.87	68.20	-28.33	Pk	Horizontal
7231.22	33.86	43.50	11.40	35.50	3.40	37.26	54.00	-16.74	AV	Horizontal
10520.35	39.66	44.50	13.90	38.80	8.20	47.86	68.20	-20.34	Pk	Vertical
10520.35	36.49	44.50	13.90	38.80	8.20	44.69	54.00	-9.31	AV	Vertical
10520.12	40.17	44.50	13.90	38.80	8.20	48.37	68.20	-19.83	Pk	Horizontal
10520.12	36.51	44.50	13.90	38.80	8.20	44.71	54.00	-9.29	AV	Horizontal
11032.63	33.28	43.60	14.30	39.50	10.20	43.48	68.20	-24.72	Pk	Vertical
11032.63	29.80	43.60	14.30	39.50	10.20	40.00	54.00	-14.00	AV	Vertical
11022.63	33.10	43.60	14.30	39.50	10.20	43.30	68.20	-24.90	Pk	Horizontal
11022.63	30.99	43.60	14.30	39.50	10.20	41.19	54.00	-12.81	AV	Horizontal
13281.29	32.87	42.60	15.90	38.90	12.20	45.07	68.20	-23.13	Pk	Vertical
13281.29	29.35	42.60	15.90	38.90	12.20	41.55	54.00	-12.45	AV	Vertical
13280.19	31.81	42.60	15.90	38.90	12.20	44.01	68.20	-24.19	Pk	Horizontal
13280.19	29.56	42.60	15.90	38.90	12.20	41.76	54.00	-12.24	AV	Horizontal
Mid Channel (802.11n (HT-20)/ 5300 MHz)										
3250.98	45.20	44.70	6.70	28.20	-9.80	35.40	68.20	-32.80	Pk	Vertical
3250.98	40.73	44.70	6.70	28.20	-9.80	30.93	54.00	-23.07	AV	Vertical
3248.81	44.07	44.70	6.70	28.20	-9.80	34.27	68.20	-33.93	Pk	Horizontal
3248.81	41.75	44.70	6.70	28.20	-9.80	31.95	54.00	-22.05	AV	Horizontal
3993.75	39.06	44.20	7.90	29.70	-6.60	32.46	68.20	-35.74	Pk	Vertical
3993.75	37.02	44.20	7.90	29.70	-6.60	30.42	54.00	-23.58	AV	Vertical
3986.46	39.24	44.20	7.90	29.70	-6.60	32.64	68.20	-35.56	Pk	Horizontal
3986.46	36.79	44.20	7.90	29.70	-6.60	30.19	54.00	-23.81	AV	Horizontal
7232.14	36.50	43.50	11.40	35.50	3.40	39.90	68.20	-28.30	Pk	Vertical
7232.14	33.45	43.50	11.40	35.50	3.40	36.85	54.00	-17.15	AV	Vertical
7234.28	37.58	43.50	11.40	35.50	3.40	40.98	68.20	-27.22	Pk	Horizontal
7234.28	34.57	43.50	11.40	35.50	3.40	37.97	54.00	-16.03	AV	Horizontal
10599.94	38.78	44.50	13.80	38.80	8.10	46.88	68.20	-21.32	Pk	Vertical
10599.94	36.17	44.50	13.80	38.80	8.10	44.27	54.00	-9.73	AV	Vertical
10600.36	39.88	44.50	13.80	38.80	8.10	47.98	68.20	-20.22	Pk	Horizontal
10600.36	36.03	44.50	13.80	38.80	8.10	44.13	54.00	-9.87	AV	Horizontal
11026.85	33.33	43.60	14.30	39.50	10.20	43.53	68.20	-24.67	Pk	Vertical
11026.85	30.35	43.60	14.30	39.50	10.20	40.55	54.00	-13.45	AV	Vertical
11022.62	32.96	43.60	14.30	39.50	10.20	43.16	68.20	-25.04	Pk	Horizontal
11022.62	30.49	43.60	14.30	39.50	10.20	40.69	54.00	-13.31	AV	Horizontal
13291.78	32.98	42.60	15.90	38.90	12.20	45.18	68.20	-23.02	Pk	Vertical
13291.78	29.83	42.60	15.90	38.90	12.20	42.03	54.00	-11.97	AV	Vertical
13280.22	32.68	42.60	15.90	38.90	12.20	44.88	68.20	-23.32	Pk	Horizontal
13280.22	28.83	42.60	15.90	38.90	12.20	41.03	54.00	-12.97	AV	Horizontal



High Channel (802.11n (HT-20)/ 5320 MHz)										
3245.40	44.45	44.70	6.70	28.20	-9.80	34.65	68.20	-33.55	Pk	Vertical
3245.40	41.82	44.70	6.70	28.20	-9.80	32.02	54.00	-21.98	AV	Vertical
3246.60	43.77	44.70	6.70	28.20	-9.80	33.97	68.20	-34.23	Pk	Horizontal
3246.60	40.99	44.70	6.70	28.20	-9.80	31.19	54.00	-22.81	AV	Horizontal
3998.92	39.85	44.20	7.90	29.70	-6.60	33.25	68.20	-34.95	Pk	Vertical
3998.92	35.75	44.20	7.90	29.70	-6.60	29.15	54.00	-24.85	AV	Vertical
3995.78	39.30	44.20	7.90	29.70	-6.60	32.70	68.20	-35.50	Pk	Horizontal
3995.78	36.73	44.20	7.90	29.70	-6.60	30.13	54.00	-23.87	AV	Horizontal
7222.32	37.61	43.50	11.40	35.50	3.40	41.01	68.20	-27.19	Pk	Vertical
7222.32	33.47	43.50	11.40	35.50	3.40	36.87	54.00	-17.13	AV	Vertical
7226.52	36.50	43.50	11.40	35.50	3.40	39.90	68.20	-28.30	Pk	Horizontal
7226.52	33.76	43.50	11.40	35.50	3.40	37.16	54.00	-16.84	AV	Horizontal
10640.10	39.49	44.50	13.80	38.80	8.10	47.59	68.20	-20.61	Pk	Vertical
10640.10	36.49	44.50	13.80	38.80	8.10	44.59	54.00	-9.41	AV	Vertical
10640.11	40.08	44.50	13.80	38.80	8.10	48.18	68.20	-20.02	Pk	Horizontal
10640.11	35.98	44.50	13.80	38.80	8.10	44.08	54.00	-9.92	AV	Horizontal
11034.63	34.07	43.60	14.30	39.50	10.20	44.27	68.20	-23.93	Pk	Vertical
11034.63	29.80	43.60	14.30	39.50	10.20	40.00	54.00	-14.00	AV	Vertical
11025.61	33.26	43.60	14.30	39.50	10.20	43.46	68.20	-24.74	Pk	Horizontal
11025.61	29.71	43.60	14.30	39.50	10.20	39.91	54.00	-14.09	AV	Horizontal
13294.88	32.70	42.70	18.00	37.10	12.40	45.10	68.20	-23.10	Pk	Vertical
13294.88	29.42	42.70	18.00	37.10	12.40	41.82	54.00	-12.18	AV	Vertical
13289.22	31.78	42.70	18.00	37.10	12.40	44.18	68.20	-24.02	Pk	Horizontal
13289.22	29.16	42.70	18.00	37.10	12.40	41.56	54.00	-12.44	AV	Horizontal

Remark:

- Factor = Antenna Factor + Cable Loss – Pre-amplifier.
- Scan with 802.11a,802.11n (HT-20),802.11n (HT-40), 802.11ac (VHT-20),802.11ac (VHT-40), 802.11ac (VHT-80) the worst case is 802.11n (HT-20).
- The frequency emission of peak points that did not show above the forms are at least 20dB below the limit, the frequency emission is mainly from the environment noise.



Band IV(5.725-5.850) GHz

Frequency (MHz)	Reading	Amplifier	Loss	Antenna Factor	Orrected Factor	Emission Level	Limit (dBuV/m)	Margin	Detector	Comment
	(dBuV)	(dB)	(dB)	(dB/m)	(dB)	(dBuV/m)		(dB)		
Low Channel (802.11n (HT-20)/ 5745 MHz)										
3257.78	44.62	44.70	6.70	28.20	-9.80	34.82	68.20	-33.38	Pk	Vertical
3257.78	40.96	44.70	6.70	28.20	-9.80	31.16	54.00	-22.84	AV	Vertical
3257.14	44.37	44.70	6.70	28.20	-9.80	34.57	68.20	-33.63	Pk	Horizontal
3257.14	41.76	44.70	6.70	28.20	-9.80	31.96	54.00	-22.04	AV	Horizontal
3980.52	38.75	44.20	7.90	29.70	-6.60	32.15	68.20	-36.05	Pk	Vertical
3980.52	36.96	44.20	7.90	29.70	-6.60	30.36	54.00	-23.64	AV	Vertical
3991.84	39.37	44.20	7.90	29.70	-6.60	32.77	68.20	-35.43	Pk	Horizontal
3991.84	35.91	44.20	7.90	29.70	-6.60	29.31	54.00	-24.69	AV	Horizontal
7226.57	36.68	43.50	11.40	35.50	3.40	40.08	68.20	-28.12	Pk	Vertical
7226.57	34.66	43.50	11.40	35.50	3.40	38.06	54.00	-15.94	AV	Vertical
7225.88	37.39	43.50	11.40	35.50	3.40	40.79	68.20	-27.41	Pk	Horizontal
7225.88	33.90	43.50	11.40	35.50	3.40	37.30	54.00	-16.70	AV	Horizontal
10510.13	39.19	44.50	13.90	38.80	8.20	47.39	68.20	-20.81	Pk	Vertical
10510.13	36.99	44.50	13.90	38.80	8.20	45.19	54.00	-8.81	AV	Vertical
10510.06	39.58	44.50	13.90	38.80	8.20	47.78	68.20	-20.42	Pk	Horizontal
10510.06	36.40	44.50	13.90	38.80	8.20	44.60	54.00	-9.40	AV	Horizontal
11490.22	33.95	43.60	14.30	39.50	10.20	44.15	68.20	-24.05	Pk	Vertical
11490.22	30.65	43.60	14.30	39.50	10.20	40.85	54.00	-13.15	AV	Vertical
11490.22	33.13	43.60	14.30	39.50	10.20	43.33	68.20	-24.87	Pk	Horizontal
11490.22	30.31	43.60	14.30	39.50	10.20	40.51	54.00	-13.49	AV	Horizontal
13299.28	31.82	42.60	15.90	38.90	12.20	44.02	68.20	-24.18	Pk	Vertical
13299.28	28.59	42.60	15.90	38.90	12.20	40.79	54.00	-13.21	AV	Vertical
13283.51	32.02	42.60	15.90	38.90	12.20	44.22	68.20	-23.98	Pk	Horizontal
13283.51	29.20	42.60	15.90	38.90	12.20	41.40	54.00	-12.60	AV	Horizontal

Mid Channel (802.11n (HT-20)/ 5785 MHz)										
3248.86	45.19	44.70	6.70	28.20	-9.80	35.39	68.20	-32.81	Pk	Vertical
3248.86	41.99	44.70	6.70	28.20	-9.80	32.19	54.00	-21.81	AV	Vertical
3263.05	44.62	44.70	6.70	28.20	-9.80	34.82	68.20	-33.38	Pk	Horizontal
3263.05	42.18	44.70	6.70	28.20	-9.80	32.38	54.00	-21.62	AV	Horizontal
3993.17	39.77	44.20	7.90	29.70	-6.60	33.17	68.20	-35.03	Pk	Vertical
3993.17	35.81	44.20	7.90	29.70	-6.60	29.21	54.00	-24.79	AV	Vertical
3992.91	39.35	44.20	7.90	29.70	-6.60	32.75	68.20	-35.45	Pk	Horizontal
3992.91	36.78	44.20	7.90	29.70	-6.60	30.18	54.00	-23.82	AV	Horizontal
7224.34	37.76	43.50	11.40	35.50	3.40	41.16	68.20	-27.04	Pk	Vertical
7224.34	34.43	43.50	11.40	35.50	3.40	37.83	54.00	-16.17	AV	Vertical
7220.12	37.71	43.50	11.40	35.50	3.40	41.11	68.20	-27.09	Pk	Horizontal
7220.12	34.44	43.50	11.40	35.50	3.40	37.84	54.00	-16.16	AV	Horizontal
10586.50	40.01	44.50	13.80	38.80	8.10	48.11	68.20	-20.09	Pk	Vertical
10586.50	36.71	44.50	13.80	38.80	8.10	44.81	54.00	-9.19	AV	Vertical
10582.03	39.17	44.50	13.80	38.80	8.10	47.27	68.20	-20.93	Pk	Horizontal
10582.03	37.14	44.50	13.80	38.80	8.10	45.24	54.00	-8.76	AV	Horizontal
11570.00	33.09	43.60	14.30	39.50	10.20	43.29	68.20	-24.91	Pk	Vertical
11570.00	29.88	43.60	14.30	39.50	10.20	40.08	54.00	-13.92	AV	Vertical
11570.39	34.09	43.60	14.30	39.50	10.20	44.29	68.20	-23.91	Pk	Horizontal
11570.39	29.98	43.60	14.30	39.50	10.20	40.18	54.00	-13.82	AV	Horizontal
13291.97	32.31	42.60	15.90	38.90	12.20	44.51	68.20	-23.69	Pk	Vertical
13291.97	30.00	42.60	15.90	38.90	12.20	42.20	54.00	-11.80	AV	Vertical
13297.53	32.34	42.60	15.90	38.90	12.20	44.54	68.20	-23.66	Pk	Horizontal
13297.53	29.18	42.60	15.90	38.90	12.20	41.38	54.00	-12.62	AV	Horizontal



High Channel (802.11n (HT-20)/ 5825 MHz)										
3246.60	44.44	44.70	6.70	28.20	-9.80	34.64	68.20	-33.56	Pk	Vertical
3246.60	41.15	44.70	6.70	28.20	-9.80	31.35	54.00	-22.65	AV	Vertical
3250.16	44.36	44.70	6.70	28.20	-9.80	34.56	68.20	-33.64	Pk	Horizontal
3250.16	40.79	44.70	6.70	28.20	-9.80	30.99	54.00	-23.01	AV	Horizontal
3993.12	38.80	44.20	7.90	29.70	-6.60	32.20	68.20	-36.00	Pk	Vertical
3993.12	36.65	44.20	7.90	29.70	-6.60	30.05	54.00	-23.95	AV	Vertical
3982.75	39.27	44.20	7.90	29.70	-6.60	32.67	68.20	-35.53	Pk	Horizontal
3982.75	37.12	44.20	7.90	29.70	-6.60	30.52	54.00	-23.48	AV	Horizontal
7217.66	37.31	43.50	11.40	35.50	3.40	40.71	68.20	-27.49	Pk	Vertical
7217.66	34.66	43.50	11.40	35.50	3.40	38.06	54.00	-15.94	AV	Vertical
7228.52	37.16	43.50	11.40	35.50	3.40	40.56	68.20	-27.64	Pk	Horizontal
7228.52	34.70	43.50	11.40	35.50	3.40	38.10	54.00	-15.90	AV	Horizontal
10634.39	39.66	44.50	13.80	38.80	8.10	47.76	68.20	-20.44	Pk	Vertical
10634.39	36.75	44.50	13.80	38.80	8.10	44.85	54.00	-9.15	AV	Vertical
10640.28	39.59	44.50	13.80	38.80	8.10	47.69	68.20	-20.51	Pk	Horizontal
10640.28	36.16	44.50	13.80	38.80	8.10	44.26	54.00	-9.74	AV	Horizontal
11649.98	33.46	43.60	14.30	39.50	10.20	43.66	68.20	-24.54	Pk	Vertical
11649.98	29.93	43.60	14.30	39.50	10.20	40.13	54.00	-13.87	AV	Vertical
11650.38	33.08	43.60	14.30	39.50	10.20	43.28	68.20	-24.92	Pk	Horizontal
11650.38	30.54	43.60	14.30	39.50	10.20	40.74	54.00	-13.26	AV	Horizontal
13282.85	32.01	42.70	18.00	37.10	12.40	44.41	68.20	-23.79	Pk	Vertical
13282.85	28.56	42.70	18.00	37.10	12.40	40.96	54.00	-13.04	AV	Vertical
13285.59	32.03	42.70	18.00	37.10	12.40	44.43	68.20	-23.77	Pk	Horizontal
13285.59	30.02	42.70	18.00	37.10	12.40	42.42	54.00	-11.58	AV	Horizontal

Remark:

- Factor = Antenna Factor + Cable Loss – Pre-amplifier.
- Scan with 802.11a,802.11n (HT-20),802.11n (HT-40), 802.11ac (VHT-20),802.11ac (VHT-40), 802.11ac (VHT-80) the worst case is 802.11n (HT-20).
- The frequency emission of peak points that did not show above the forms are at least 20dB below the limit, the frequency emission is mainly from the environment noise.



3.2.9 Band Edge

Band I 5150-5250MHz

802.11n (HT-20) Low
Horizontal

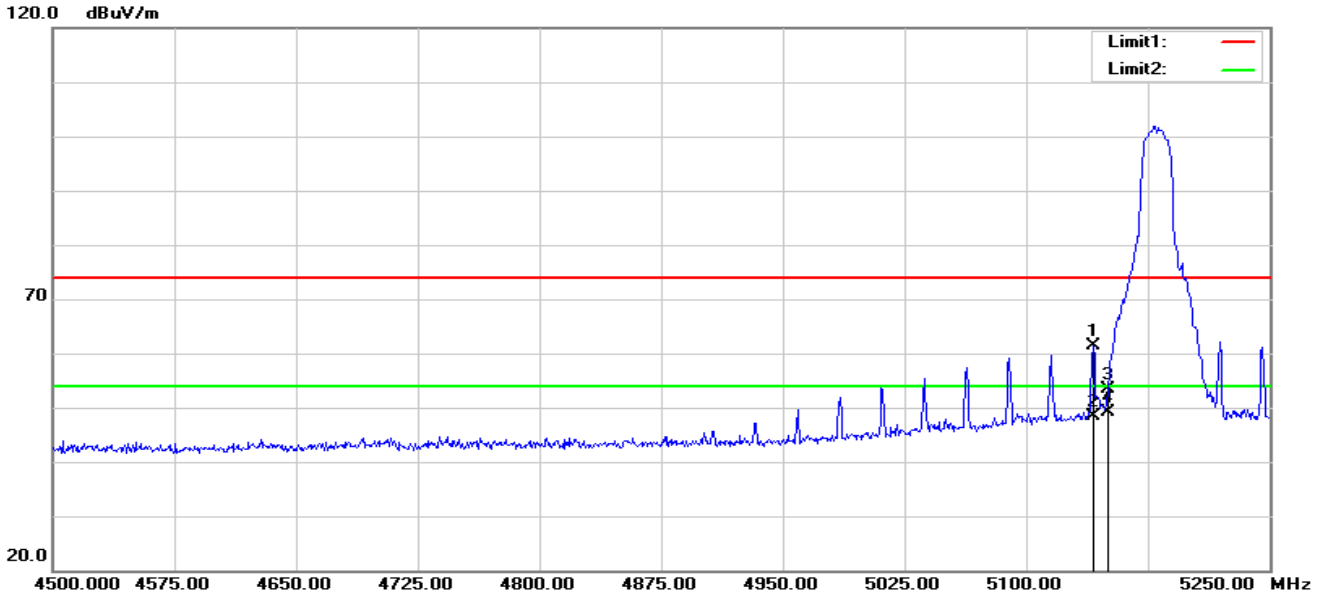

No.	Frequency (MHz)	Reading (dBuV)	Correct Factor(dB/m)	Result (dBuV/m)	Limit (dBuV/m)	Margin (dB)	Remark
1	5141.250	67.11	-5.74	61.37	74.00	-12.63	peak
2	5141.250	54.19	-5.74	48.45	54.00	-5.55	AVG
3	5150.000	59.06	-5.73	53.33	74.00	-20.67	peak
4	5150.000	54.94	-5.73	49.21	54.00	-4.79	AVG

Vertical

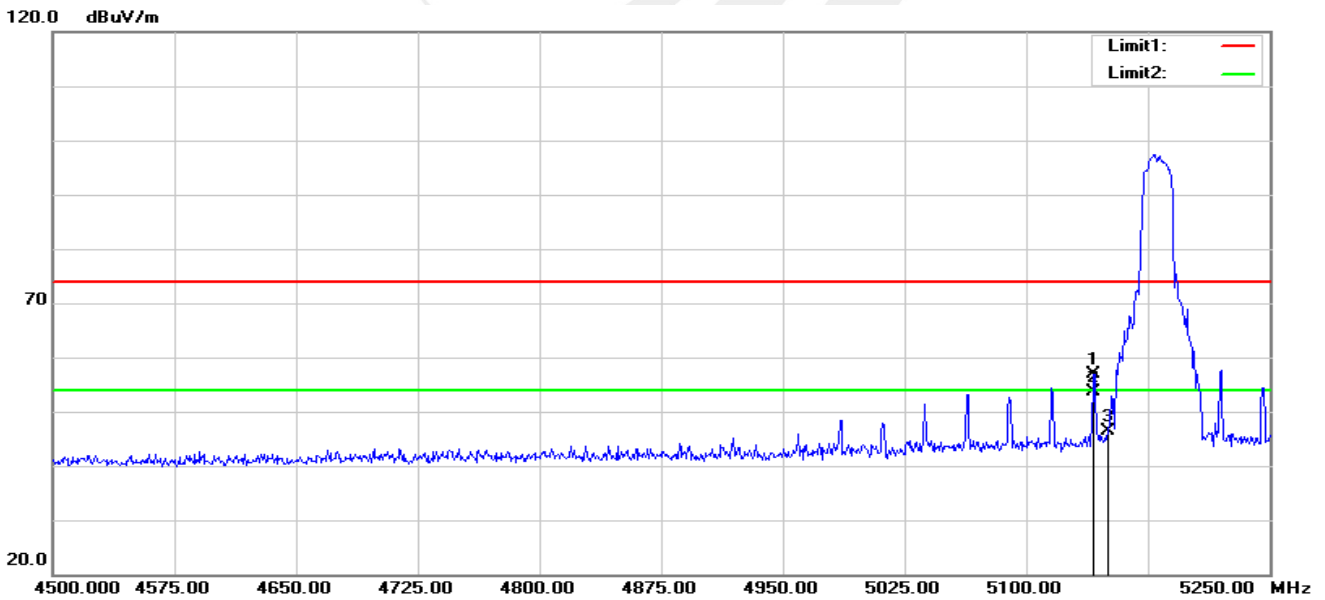

No.	Frequency (MHz)	Reading (dBuV)	Correct Factor(dB/m)	Result (dBuV/m)	Limit (dBuV/m)	Margin (dB)	Remark
1	5141.250	62.67	-5.74	56.93	74.00	-17.07	peak
2	5141.250	59.48	-5.74	53.74	54.00	-0.26	AVG
3	5150.000	52.14	-5.73	46.41	74.00	-27.59	peak



802.11n (HT-20) High Horizontal

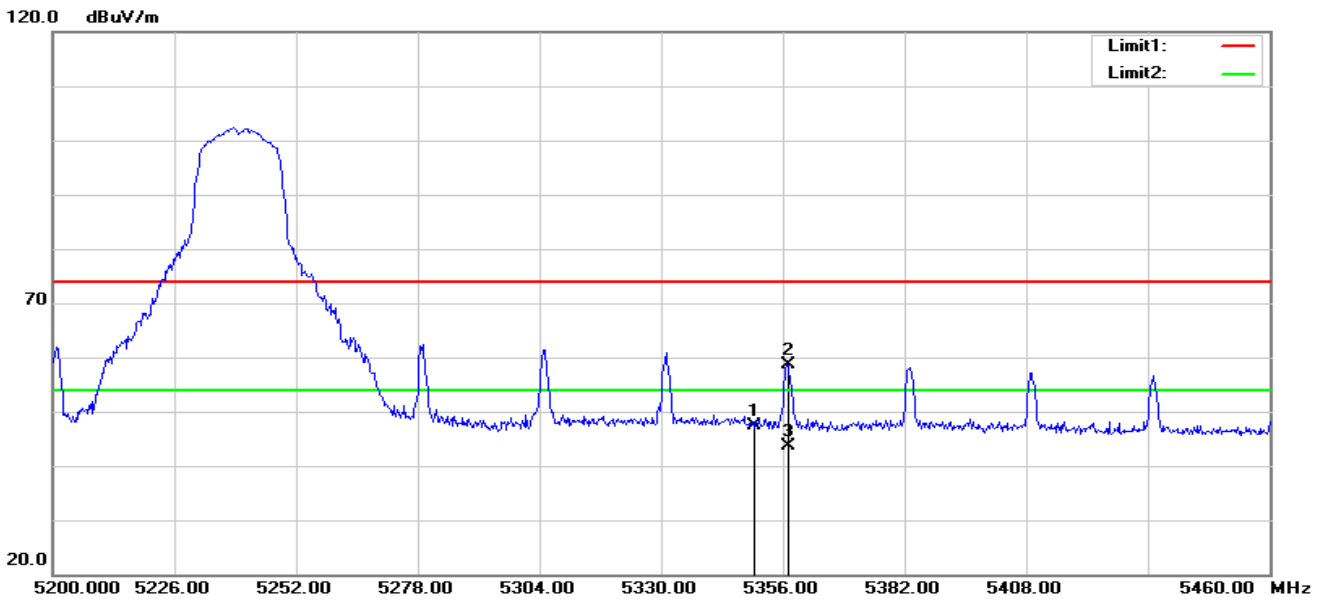

No.	Frequency (MHz)	Reading (dBuV)	Correct Factor(dB/m)	Result (dBuV/m)	Limit (dBuV/m)	Margin (dB)	Remark
1	5350.000	52.54	-5.23	47.31	74.00	-26.69	peak
2	5357.040	63.93	-5.23	58.70	74.00	-15.30	peak
3	5357.040	48.84	-5.23	43.61	54.00	-10.39	AVG

Vertical

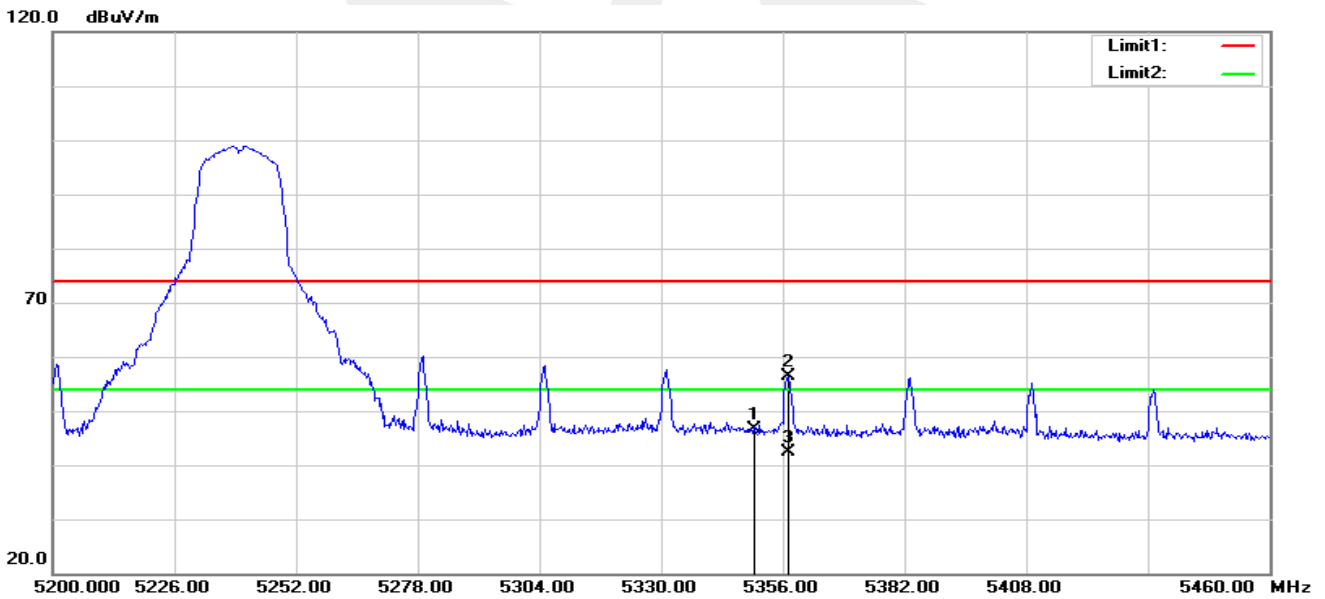

No.	Frequency (MHz)	Reading (dBuV)	Correct Factor(dB/m)	Result (dBuV/m)	Limit (dBuV/m)	Margin (dB)	Remark
1	5350.000	51.87	-5.23	46.64	74.00	-27.36	peak
2	5357.300	61.53	-5.23	56.30	74.00	-17.70	peak
3	5357.300	47.61	-5.23	42.38	54.00	-11.62	AVG

Note: 802.11a,802.11n (HT-20),802.11n (HT-40), 802.11ac (VHT-20),802.11ac (VHT-40), 802.11ac (VHT-80) all has been tested, the worst case is 802.11n (HT-20),only shown the worst case.



Band II 5250-5350MHz

802.11n (HT-20) Low
Horizontal

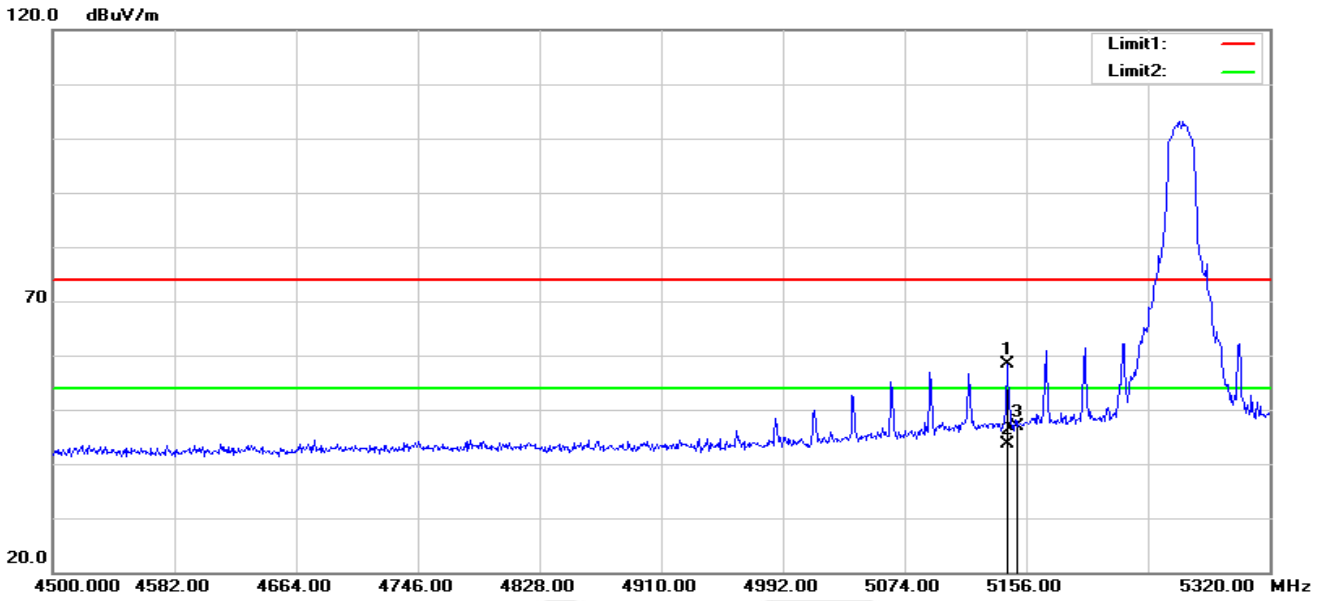

No.	Frequency (MHz)	Reading (dBuV)	Correct Factor(dB/m)	Result (dBuV/m)	Limit (dBuV/m)	Margin (dB)	Remark
1	5142.880	64.08	-5.74	58.34	74.00	-15.66	peak
2	5142.880	49.28	-5.74	43.54	54.00	-10.46	AVG
3	5150.000	52.49	-5.73	46.76	74.00	-27.24	peak

Vertical

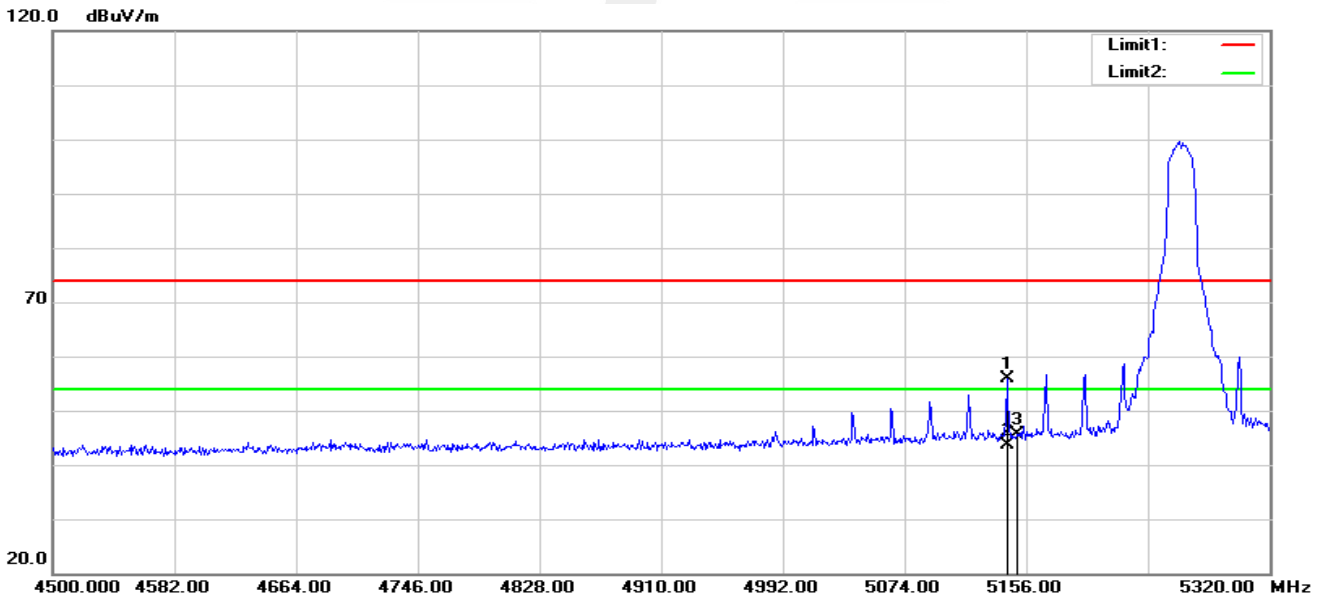

No.	Frequency (MHz)	Reading (dBuV)	Correct Factor(dB/m)	Result (dBuV/m)	Limit (dBuV/m)	Margin (dB)	Remark
1	5142.880	61.68	-5.74	55.94	74.00	-18.06	peak
2	5142.880	49.36	-5.74	43.62	54.00	-10.38	AVG
3	5150.000	51.46	-5.73	45.73	74.00	-28.27	peak



802.11n (HT-20) High Horizontal

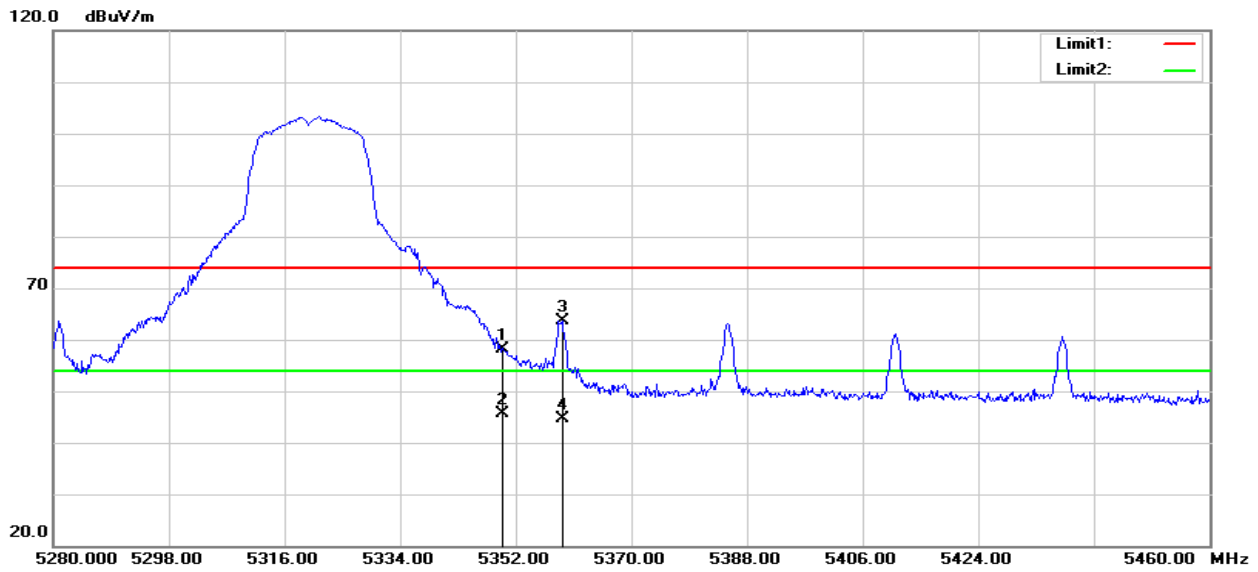

No.	Frequency (MHz)	Reading (dBuV)	Correct Factor(dB/m)	Result (dBuV/m)	Limit (dBuV/m)	Margin (dB)	Remark
1	5350.000	63.27	-5.23	58.04	74.00	-15.96	peak
2	5350.000	50.86	-5.23	45.63	54.00	-8.37	AVG
3	5359.200	68.89	-5.23	63.66	74.00	-10.34	peak
4	5359.200	49.83	-5.23	44.60	54.00	-9.40	AVG

Vertical

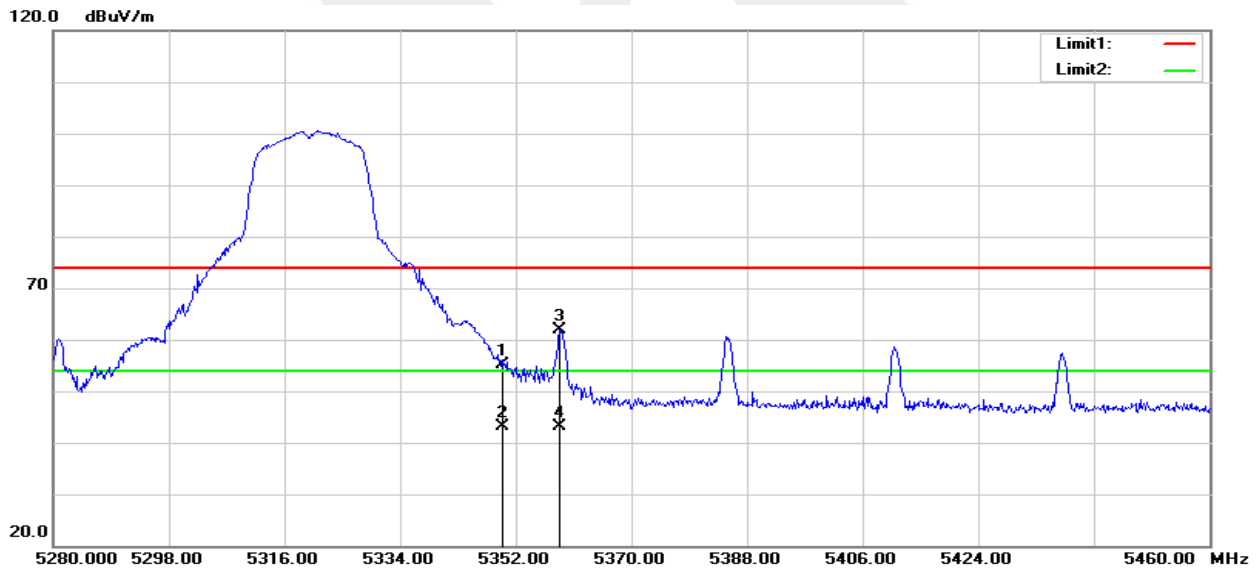

No.	Frequency (MHz)	Reading (dBuV)	Correct Factor(dB/m)	Result (dBuV/m)	Limit (dBuV/m)	Margin (dB)	Remark
1	5350.000	60.24	-5.23	55.01	74.00	-18.99	peak
2	5350.000	48.37	-5.23	43.14	54.00	-10.86	AVG
3	5358.840	67.15	-5.23	61.92	74.00	-12.08	peak
4	5358.840	48.29	-5.23	43.06	54.00	-10.94	AVG

Note: 802.11a,802.11n (HT-20),802.11n (HT-40), 802.11ac (VHT-20),802.11ac (VHT-40), 802.11ac (VHT-80) all has been tested, the worst case is 802.11n (HT-20),only shown the worst case.

Band IV(5.725-5.85 GHz)

Note: The main frequency is too far away from the restricted band and does not require testing.



4. CONDUCTED SPURIOUS EMISSIONS AND BANDEDGE

4.1 LIMIT

Undesirable emission limits. Except as shown in paragraph (b)(7) of this section, the maximum emissions outside of the frequency bands of operation shall be attenuated in accordance with the following limits:

- (1) For transmitters operating in the 5.15-5.25 GHz band: All emissions outside of the 5.15-5.35 GHz band shall not exceed an e.i.r.p. of -27 dBm/MHz.
- (2) For transmitters operating in the 5.25-5.35 GHz band: All emissions outside of the 5.15-5.35 GHz band shall not exceed an e.i.r.p. of -27 dBm/MHz.
- (3) For transmitters operating in the 5.47-5.725 GHz band: All emissions outside of the 5.47-5.725 GHz band shall not exceed an e.i.r.p. of -27 dBm/MHz.
- (4) For transmitters operating in the 5.725-5.85 GHz band:
 - (i) All emissions shall be limited to a level of -27 dBm/MHz at 75 MHz or more above or below the band edge increasing linearly to 10 dBm/MHz at 25 MHz above or below the band edge, and from 25 MHz above or below the band edge increasing linearly to a level of 15.6 dBm/MHz at 5 MHz above or below the band edge, and from 5 MHz above or below the band edge increasing linearly to a level of 27 dBm/MHz at the band edge.

4.2 TEST PROCEDURE

Spectrum Parameter	Setting
Detector	Peak
Start/Stop Frequency	30 MHz to 10th carrier harmonic
RB / VB (emission in restricted band)	1000 KHz/3000 KHz
Trace-Mode:	Max hold

For Band edge

Spectrum Parameter	Setting
Detector	Peak
Start/Stop Frequency	Lower Band Edge: 5700 to 5725 MHz Upper Band Edge: 5850 to 5870 MHz
RB / VB (emission in restricted band)	1000 KHz/3000 KHz
Trace-Mode:	Max hold

4.3 DEVIATION FROM STANDARD

No deviation.

4.4 TEST SETUP

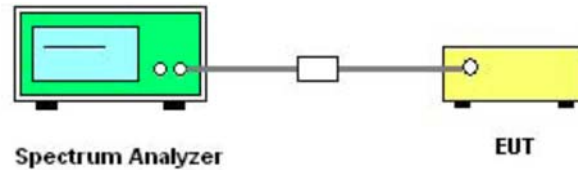

The EUT which is powered by the Battery, is coupled to the Spectrum Analyzer; the RF load attached to the EUT antenna terminal is 50Ohm; the path loss as the factor is calibrated to correct the reading.

Make the measurement with the spectrum analyzer's resolution bandwidth (RBW) = 1000 kHz. In order to make an accurate measurement, set the span greater than RBW.

4.5 EUT OPERATION CONDITIONS

The EUT tested system was configured as the statements of 2.3 Unless otherwise a special operating condition is specified in the follows during the testing.

4.6 TEST RESULTS

Data See Attachment A.





5. POWER SPECTRAL DENSITY TEST

5.1 LIMIT

1. For mobile and portable client devices in the 5.15-5.25 GHz band, , the maximum power spectral density shall not exceed 11 dBm in any 1 megahertz band. If transmitting antennas of directional gain greater than 6 dBi are used, both the maximum conducted output power and the maximum power spectral density shall be reduced by the amount in dB that the directional gain of the antenna exceeds 6 dBi.
2. For the 5.25-5.35 GHz and 5.47-5.725 GHz bands, the maximum power spectral density shall not exceed 11 dBm in any 1 megahertz band. If transmitting antennas of directional gain greater than 6 dBi are used, both the maximum conducted output power and the maximum power spectral density shall be reduced by the amount in dB that the directional gain of the antenna exceeds 6 dBi.
3. For the band 5.725-5.850 GHz, the peak power spectral density shall not exceed 30 dBm in any 500KHz band. If transmitting antenna directional gain is greater than 6 dBi, both the maximum conducted output power and the peak power spectral density shall be reduced by the amount in dB that the directional gain of the antenna exceeds 6 dBi.

5.2 TEST PROCEDURE

1. The setting follows Method SA-1 of FCC KDB D02 General UNII Test Procedures New Rules v01r03.

For devices operating in the band, the rules specify a measurement bandwidth of 500 kHz.

Many spectrum analyzers do not have 500 kHz RBW, thus a narrower RBW may need to be used.

The rules permit the use of a RBWs less than 1 MHz, or 500 kHz, “provided that the measured power is integrated over the full reference bandwidth” to show the total power over the specified measurement bandwidth (*i.e.*, 1 MHz, or 500 kHz). If measurements are performed using a reduced resolution bandwidth (< 1 MHz, or < 500 kHz) and integrated over 1 MHz, or 500 KHz bandwidth, the following adjustments to the procedures apply:

- a) Set $RBW \geq 1/T$, where T is defined in section II.B.I.a).
- b) Set $VBW \geq 3 RBW$.
- c) If measurement bandwidth of Maximum PSD is specified in 500 kHz, add $10 \log (500\text{kHz}/RBW)$ to the measured result, whereas $RBW (< 500 \text{ kHz})$ is the reduced resolution bandwidth of the spectrum analyzer set during measurement.
- d) If measurement bandwidth of Maximum PSD is specified in 1 MHz, add $10 \log (1\text{MHz}/RBW)$ to the measured result, whereas $RBW (< 1 \text{ MHz})$ is the reduced resolution bandwidth of spectrum analyzer set during measurement.
- e) Care must be taken to ensure that the measurements are performed during a period of continuous transmission or are corrected upward for duty cycle.

Note: As a practical matter, it is recommended to use reduced RBW of 100 kHz for the sections 5.c) and 5.d) above, since $RBW=100 \text{ KHZ}$ is available on nearly all spectrum analyzers.



5.3 DEVIATION FROM STANDARD

No deviation.

5.4 TEST SETUP



5.5 EUT OPERATION CONDITIONS

The EUT tested system was configured as the statements of 2.1 Unless otherwise a special operating condition is specified in the follows during the testing.

5.6 TEST RESULTS

5150-5250MHz					
Frequency	Power Density(dBm)	Duty cycle factor (dB)	Power Density(dBm)	Limit	Result
802.11a					
5180	8.391	0.080	8.471	11	PASS
5200	8.242	0.080	8.322	11	PASS
5240	7.686	0.080	7.766	11	PASS
802.11n20					
5180	8.295	0.050	8.345	11	PASS
5200	7.804	0.050	7.854	11	PASS
5240	7.450	0.050	7.500	11	PASS
802.11n40					
5190	3.076	0.168	3.244	11	PASS
5230	3.135	0.168	3.303	11	PASS
802.11ac20					
5180	8.296	0.081	8.377	11	PASS
5200	9.536	0.081	9.617	11	PASS
5240	7.393	0.081	7.474	11	PASS
802.11ac40					
5190	2.901	0.190	3.091	11	PASS
5230	3.675	0.190	3.865	11	PASS
802.11ac80					
5210	-2.523	0.340	-2.183	11	PASS



5250-5350MHz					
Frequency	Power Density(dBm)	Duty cycle factor (dB)	Power Density(dBm)	Limit	Result
802.11a					
5260	8.159	0.050	8.209	11	PASS
5300	8.101	0.050	8.151	11	PASS
5320	8.517	0.050	8.567	11	PASS
802.11n20					
5260	7.387	0.070	7.457	11	PASS
5300	8.154	0.070	8.224	11	PASS
5320	8.487	0.070	8.557	11	PASS
802.11n40					
5270	3.282	0.182	3.464	11	PASS
5310	3.886	0.182	4.068	11	PASS
802.11ac20					
5260	7.465	0.081	7.546	11	PASS
5300	8.092	0.081	8.173	11	PASS
5320	8.465	0.081	8.546	11	PASS
802.11ac40					
5270	3.051	0.190	3.241	11	PASS
5310	3.408	0.190	3.598	11	PASS
802.11ac80					
5290	-2.624	0.340	-2.284	11	PASS

5725-5850MHz					
Frequency	Power Density(dBm)	Duty cycle factor (dB)	Power Density(dBm)	Limit	Result
802.11a					
5745	6.712	0.050	6.762	30	PASS
5785	7.636	0.050	7.686	30	PASS
5825	6.838	0.050	6.888	30	PASS
802.11n20					
5745	7.160	0.030	7.190	30	PASS
5785	7.591	0.030	7.621	30	PASS
5825	6.795	0.030	6.825	30	PASS
802.11n40					
5755	4.124	0.194	4.318	30	PASS
5795	3.724	0.194	3.918	30	PASS
802.11ac20					
5745	7.001	0.065	7.066	30	PASS
5785	7.175	0.065	7.240	30	PASS
5825	7.015	0.065	7.080	30	PASS
802.11ac40					
5755	3.955	0.190	4.145	30	PASS
5795	4.042	0.190	4.232	30	PASS
802.11ac80					
5775	-0.276	0.400	0.124	30	PASS

Test plot see Attachment B.

6. BANDWIDTH MEASUREMENT

6.1 EMISSION BANDWIDTH (EBW) 26 BANDWID PROCEDURES / LIMIT

See list of measuring instruments of this test report.

6.1.1 TEST PROCEDURE

1. The testing follows FCC KDB 789033 D02 General UNII Test Procedures New Rules v02r01
2. Set RBW = approximately 1% of the emission bandwidth.
3. Set the VBW \geq RBW.
4. Detector = Peak.
5. Trace mode = max hold.
6. Measure the maximum width of the emission that is 26 dB down from the peak of the emission. Compare this with the RBW setting of the analyzer. Readjust RBW and repeat measurement as needed until the RBW/EBW ratio is approximately 1%.

6.1.2 DEVIATION FROM STANDARD

No deviation.

6.1.3 TEST SETUP



6.1.4 EUT OPERATION CONDITIONS

The EUT tested system was configured as the statements of 2.4 Unless otherwise a special operating condition is specified in the follows during the testing.

**6.1.5 TEST RESULTS**

Frequency (MHz)	26dB Bandwidth (MHz)	Pass/Fail
802.11a		
5180	20.48	Pass
5200	20.39	Pass
5240	20.19	Pass
802.11n(HT20)		
5180	20.33	Pass
5200	19.96	Pass
5240	19.84	Pass
802.11n(HT40)		
5190	40.91	Pass
5230	40.79	Pass
802.11ac(VHT20)		
5180	20.31	Pass
5200	20.35	Pass
5240	19.80	Pass
802.11ac(VHT40)		
5190	47.09	Pass
5230	40.85	Pass
802.11ac(VHT80)		
5210	81.33	Pass

Frequency (MHz)	26dB Bandwidth (MHz)	Pass/Fail
802.11a		
5260	20.19	Pass
5300	20.13	Pass
5320	19.85	Pass
802.11n(HT20)		
5260	19.85	Pass
5300	19.77	Pass
5320	19.80	Pass
802.11n(HT40)		
5270	40.20	Pass
5310	40.28	Pass
802.11ac(VHT20)		
5260	19.81	Pass
5300	19.90	Pass
5320	19.77	Pass
802.11ac(VHT40)		
5270	40.09	Pass
5310	40.21	Pass
802.11ac(VHT80)		
5290	81.53	Pass



Frequency (MHz)	26dB Bandwidth (MHz)	Pass/Fail
802.11a		
5745	20.37	Pass
5785	20.32	Pass
5825	20.25	Pass
802.11n(HT20)		
5745	20.36	Pass
5785	19.88	Pass
5825	20.44	Pass
802.11n(HT40)		
5755	44.70	Pass
5795	40.64	Pass
802.11ac(VHT20)		
5745	19.93	Pass
5785	19.74	Pass
5825	19.93	Pass
802.11ac(VHT40)		
5755	40.41	Pass
5795	40.06	Pass
802.11ac(VHT80)		
5775	84.70	Pass

Test plot see Attachment C.

6.2 OCCUPIED BANDWIDTH (99%) TEST APPLIED PROCEDURES / LIMIT

The following procedure shall be used for measuring (99 %) power bandwidth:

6.2.1 TEST PROCEDURE

1. The testing follows FCC KDB 789033 D02 General UNII Test Procedures v02r01.

The following procedure shall be used for measuring (99 %) power bandwidth:

1. Set center frequency to the nominal EUT channel center frequency.
2. Set span = 1.5 times to 5.0 times the OBW.
3. Set RBW = 1 % to 5 % of the OBW
4. Set VBW $\geq 3 \cdot$ RBW
5. Video averaging is not permitted. Where practical, a sample detection and single sweep mode shall be used. Otherwise, peak detection and max hold mode (until the trace stabilizes) shall be used.
6. Use the 99 % power bandwidth function of the instrument (if available).
7. If the instrument does not have a 99 % power bandwidth function, the trace data points are recovered and directly summed in power units. The recovered amplitude data points, beginning at the lowest frequency, are placed in a running sum until 0.5 % of the total is reached; that frequency is recorded as the lower frequency. The process is repeated until 99.5 % of the total is reached; that frequency is recorded as the upper frequency. The 99% occupied bandwidth is the difference between these two frequencies.

6.2.2 DEVIATION FROM STANDARD

No deviation.

6.2.3 TEST SETUP

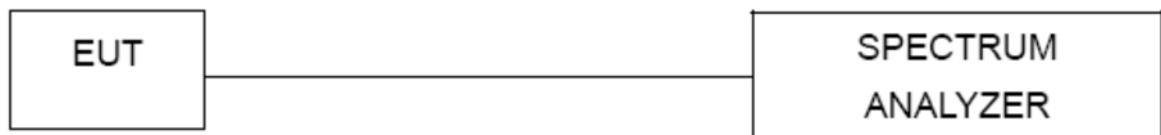

6.2.4 EUT OPERATION CONDITIONS

The EUT tested system was configured as the statements of 2.4 Unless otherwise a special operating condition is specified in the follows during the testing.



6.2.5 TEST RESULTS

Frequency (MHz)	99% Bandwidth (MHz)	Pass/Fail
802.11a		
5180	16.45	Pass
5200	16.45	Pass
5240	16.40	Pass
802.11n(HT20)		
5180	17.53	Pass
5200	17.52	Pass
5240	17.50	Pass
802.11n(HT40)		
5190	35.94	Pass
5230	35.89	Pass
802.11ac(VHT20)		
5180	17.54	Pass
5200	17.53	Pass
5240	17.51	Pass
802.11ac(VHT40)		
5190	36.01	Pass
5230	35.92	Pass
802.11ac(VHT80)		
5210	75.75	Pass

Frequency (MHz)	99% Bandwidth (MHz)	Pass/Fail
802.11a		
5260	16.44	Pass
5300	16.43	Pass
5320	16.43	Pass
802.11n(HT20)		
5260	17.50	Pass
5300	17.49	Pass
5320	17.50	Pass
802.11n(HT40)		
5270	35.91	Pass
5310	35.90	Pass
802.11ac(VHT20)		
5260	17.49	Pass
5300	17.50	Pass
5320	17.48	Pass
802.11ac(VHT40)		
5270	35.85	Pass
5310	35.89	Pass
802.11ac(VHT80)		
5290	75.84	Pass



Frequency (MHz)	99% Bandwidth (MHz)	Pass/Fail
802.11a		
5745	16.49	Pass
5785	16.44	Pass
5825	16.46	Pass
802.11n(HT20)		
5745	17.51	Pass
5785	17.50	Pass
5825	17.52	Pass
802.11n(HT40)		
5755	35.97	Pass
5795	35.89	Pass
802.11ac(VHT20)		
5745	17.49	Pass
5785	17.49	Pass
5825	17.51	Pass
802.11ac(VHT40)		
5755	35.87	Pass
5795	35.87	Pass
802.11ac(VHT80)		
5775	75.74	Pass

Test plot See Attachment C.

6.3 MINIMUM EMISSION BANDWIDTH(6 DB) PROCEDURES / LIMIT

Section 15.407(e) specifies the minimum 6 dB emission bandwidth of at least 500 KHz for the band 5.725-5.85 GHz. The following procedure shall be used for measuring this bandwidth:

6.3.1 TEST PROCEDURE

1. The testing follows FCC KDB 789033 D02 General UNII Test Procedures v02r01.
 - a) Set RBW = 100 kHz.
 - b) Set the video bandwidth (VBW) $\geq 3 \times$ RBW.
 - c) Detector = Peak.
 - d) Trace mode = max hold.
 - e) Sweep = auto couple.
 - f) Allow the trace to stabilize.
 - g) Measure the maximum width of the emission that is constrained by the frequencies associated with the two outermost amplitude points (upper and lower frequencies) that are attenuated by 6 dB relative to the maximum level measured in the fundamental emission.

6.3.2 DEVIATION FROM STANDARD

No deviation.

6.3.3 TEST SETUP



6.3.4 EUT OPERATION CONDITIONS

The EUT tested system was configured as the statements of 2.4 Unless otherwise a special operating condition is specified in the follows during the testing.

**6.3.5 TEST RESULTS**

Frequency (MHz)	6dB Bandwidth (MHz)	Pass/Fail
802.11a		
5745	15.01	Pass
5785	15.06	Pass
5825	15.05	Pass
802.11n(HT20)		
5745	15.09	Pass
5785	15.09	Pass
5825	15.10	Pass
802.11n(HT40)		
5755	35.08	Pass
5795	35.04	Pass
802.11ac(VHT20)		
5745	15.05	Pass
5785	15.10	Pass
5825	15.10	Pass
802.11ac(VHT40)		
5755	35.08	Pass
5795	35.02	Pass
802.11ac(VHT80)		
5775	75.69	Pass

Test plots see Attachment D.

7. MAXIMUM CONDUCTED OUTPUT POWER

7.1 LIMIT

For mobile and portable client devices in the 5.15-5.25 GHz band, the maximum conducted output power over the frequency band of operation shall not exceed 250 mW provided the maximum antenna gain does not exceed 6 dBi. If transmitting antennas of directional gain greater than 6 dBi are used, both the maximum conducted output power and the maximum power spectral density shall be reduced by the amount in dB that the directional gain of the antenna exceeds 6 dBi.

For the 5.25-5.35 GHz and 5.47-5.725 GHz bands, the maximum conducted output power over the frequency bands of operation shall not exceed the lesser of 250 mW or 11 dBm + 10 log B, where B is the 26 dB emission bandwidth in megahertz, If transmitting antennas of directional gain greater than 6 dBi are used.

For the band 5.725-5.85 GHz, the maximum conducted output power over the frequency band of operation shall not exceed 1 W. If transmitting antennas of directional gain greater than 6 dBi are used.

FCC Part15 (15.407) , Subpart E				
Section	Test Item	Limit	Frequency Range (MHz)	Result
15.407(a) (1) (iv)	Peak Output Power	0.25 watt	5150-5250	PASS
		The lesser of 250 mW or 11 dBm + 10 log (26 dB emission bandwidth)	5250-5350 5470-5725	
15.407(a) (3)		1 watt	5725-5825	

7.2 TEST PROCEDURE

The EUT was directly connected to the Power Sensor&PC

7.3 DEVIATION FROM STANDARD

No deviation.

7.4 TEST SETUP

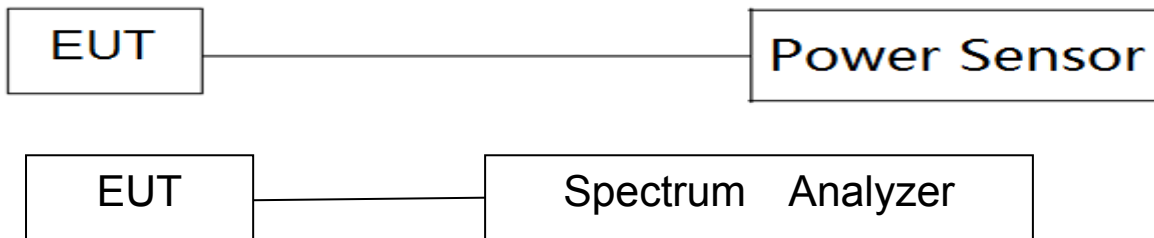

7.5 EUT OPERATION CONDITIONS

The EUT tested system was configured as the statements of 5 Unless otherwise a special operating condition is specified in the follows during the testing.



7.6 TEST RESULTS

Note:

1. For mobile and portable client devices in the 5.15-5.25 GHz band, the maximum conducted output power over the frequency band of operation shall not exceed the lesser of 0.25 W.
2. For mobile and portable client devices in the 5.25-5.35 GHz band, the maximum conducted output power over the frequency band of operation shall not exceed the lesser of 0.25 W.
3. For the band 5.745-5.850 GHz, the maximum conducted output power over the frequency band of operation shall not exceed the lesser of 1 W.

Band I (5.15-5.25GHz)					
Test Channel	Frequency (MHz)	AV Power (dBm)	Duty cycle factor	AV Power (dBm)	LIMIT (dBm)
802.11a					
36	5180	12.75	0.08	12.83	23.98
40	5200	12.05	0.08	12.13	23.98
48	5240	12.58	0.08	12.66	23.98
802.11n(HT20)					
36	5180	12.55	0.05	12.60	23.98
40	5200	11.90	0.05	11.95	23.98
48	5240	12.42	0.05	12.47	23.98
802.11n(HT40)					
38	5190	10.34	0.17	10.51	23.98
46	5230	9.80	0.17	9.97	23.98
802.11ac(VHT20)					
36	5180	12.63	0.08	12.71	23.98
40	5200	12.55	0.08	12.63	23.98
48	5240	11.84	0.08	11.92	23.98
802.11ac(VHT40)					
38	5190	10.36	0.19	10.55	23.98
46	5230	10.25	0.19	10.44	23.98
802.11ac(VHT80)					
42	5210	8.39	0.34	8.73	23.98



Band II(5.25-5.35GHz)					
Test Channel	Frequency (MHz)	AV Power (dBm)	Duty cycle factor	AV Power (dBm)	LIMIT (dBm)
802.11a					
52	5260	12.51	0.05	12.56	23.98
60	5300	12.34	0.05	12.39	23.98
64	5320	12.99	0.05	13.04	23.978
802.11n(HT20)					
52	5260	12.33	0.07	12.40	23.978
60	5300	12.20	0.07	12.27	23.96
64	5320	12.83	0.07	12.90	23.967
802.11n(HT40)					
54	5270	10.31	0.18	10.49	23.98
62	5310	10.67	0.18	10.85	23.98
802.11ac(VHT20)					
52	5260	12.38	0.08	12.46	23.969
60	5300	12.20	0.08	12.28	23.98
64	5320	12.98	0.08	13.06	23.96
802.11ac(VHT40)					
54	5270	10.28	0.19	10.47	23.98
62	5310	10.14	0.19	10.33	23.98
802.11ac(VHT80)					
58	5290	8.00	0.34	8.34	23.98

Band IV (5.725-5.85GHz)					
Test Channel	Frequency (MHz)	AV Power (dBm)	Duty cycle factor	AV Power (dBm)	LIMIT (dBm)
802.11a					
149	5745	10.42	0.05	10.47	30
157	5785	9.87	0.05	9.92	30
165	5825	9.75	0.05	9.80	30
802.11n(HT20)					
149	5745	10.23	0.03	10.26	30
157	5785	10.23	0.03	10.26	30
165	5825	9.53	0.03	9.56	30
802.11n(HT40)					
151	5755	9.93	0.19	10.12	30
159	5795	9.70	0.19	9.89	30
802.11ac(VHT20)					
149	5745	10.22	0.07	10.29	30
157	5785	10.18	0.07	10.25	30
165	5825	9.05	0.07	9.12	30
802.11ac(VHT40)					
151	5755	9.88	0.19	10.07	30
159	5795	9.20	0.19	9.39	30
802.11ac(VHT80)					
155	5775	10.62	0.40	11.02	30



802.11ac HT80(5210MHz)

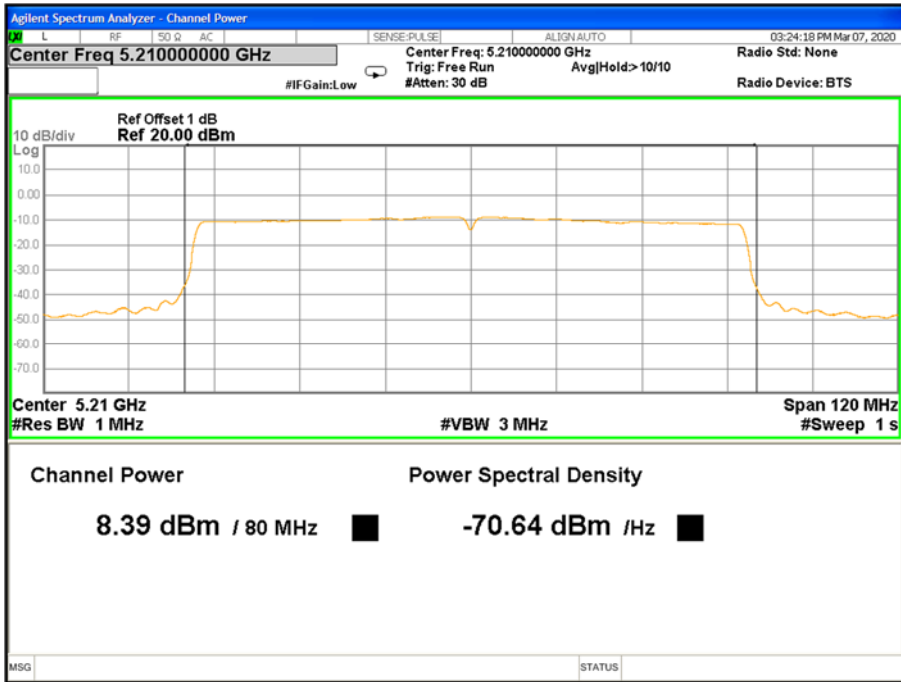

802.11ac VHT80(5290MHz)

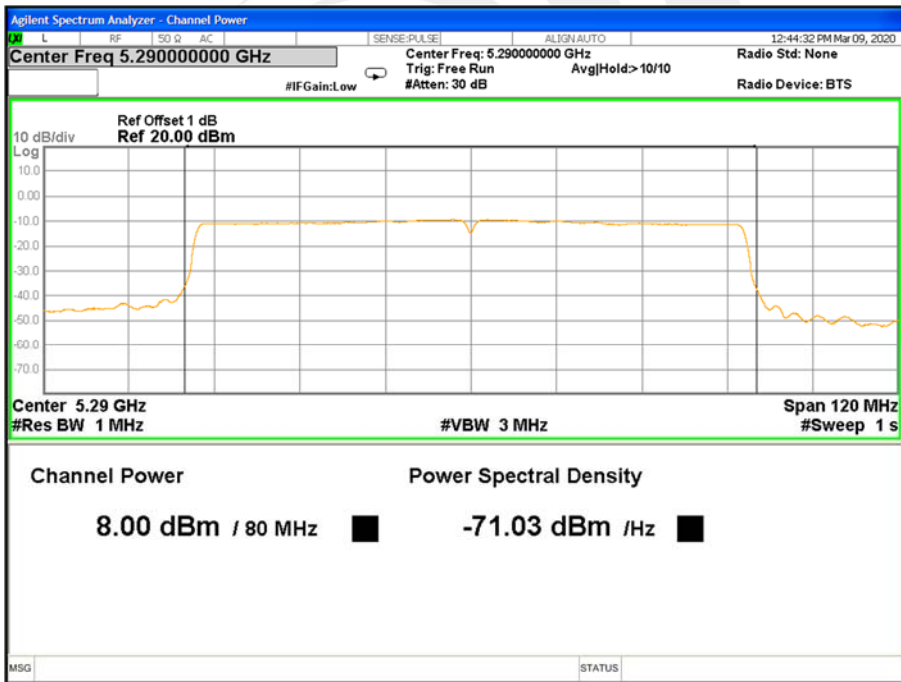



802.11ac VHT80(5775MHz)

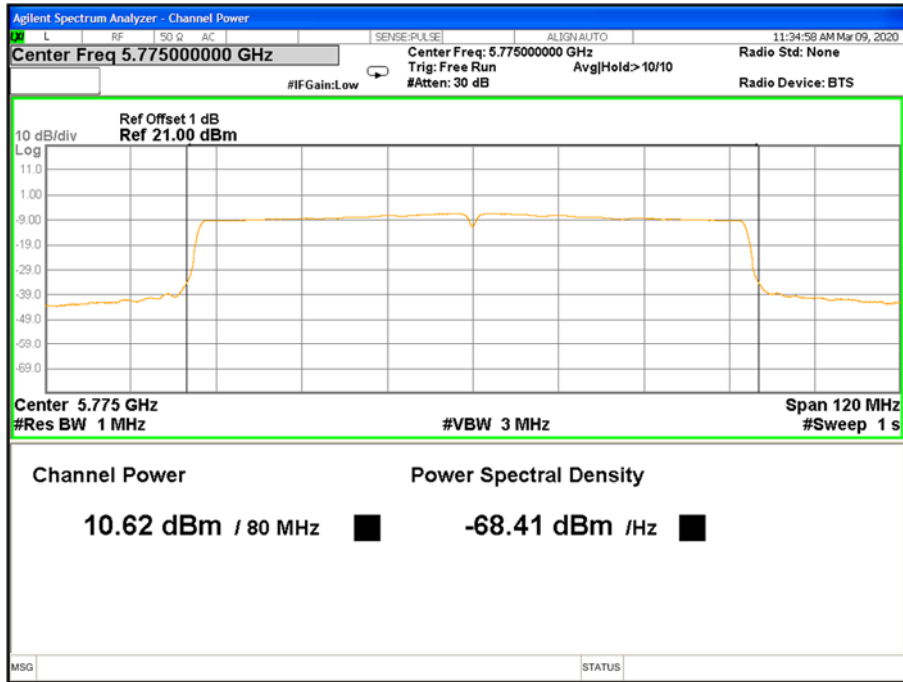



Duty cycle

Band 1				
Mode	Ton	Tp	Duty cycle(%)	Duty factor(dB)
a	1.405	1.430	98.25%	0.08
n20	1.320	1.335	98.88%	0.05
n40	0.660	0.686	96.21%	0.17
ac20	1.330	1.355	98.15%	0.08
ac40	0.658	0.688	95.64%	0.19
ac80	0.332	0.359	92.48%	0.34
Band 2				
Mode	Ton	Tp	Duty cycle(%)	Duty factor(dB)
a	1.405	1.420	98.94%	0.05
n20	1.320	1.340	98.51%	0.07
n40	0.656	0.684	95.91%	0.18
ac20	1.325	1.350	98.15%	0.08
ac40	0.660	0.690	95.65%	0.19
ac80	0.331	0.358	92.46%	0.34
Band 4				
Mode	Ton	Tp	Duty cycle(%)	Duty factor(dB)
a	1.415	1.430	98.95%	0.05
n20	1.325	1.335	99.25%	0.03
n40	0.656	0.686	95.63%	0.19
ac20	1.325	1.345	98.51%	0.07
ac40	0.660	0.690	95.65%	0.19
ac80	0.328	0.360	91.11%	0.40



Band 1
802.11 a



802.11n(HT20)





802.11n(HT40)



802.11ac(VHT20)





802.11ac(VHT40)



802.11ac(VHT80)





Band 2
802.11 a



802.11n(HT20)





802.11n(HT40)



802.11ac(VHT20)

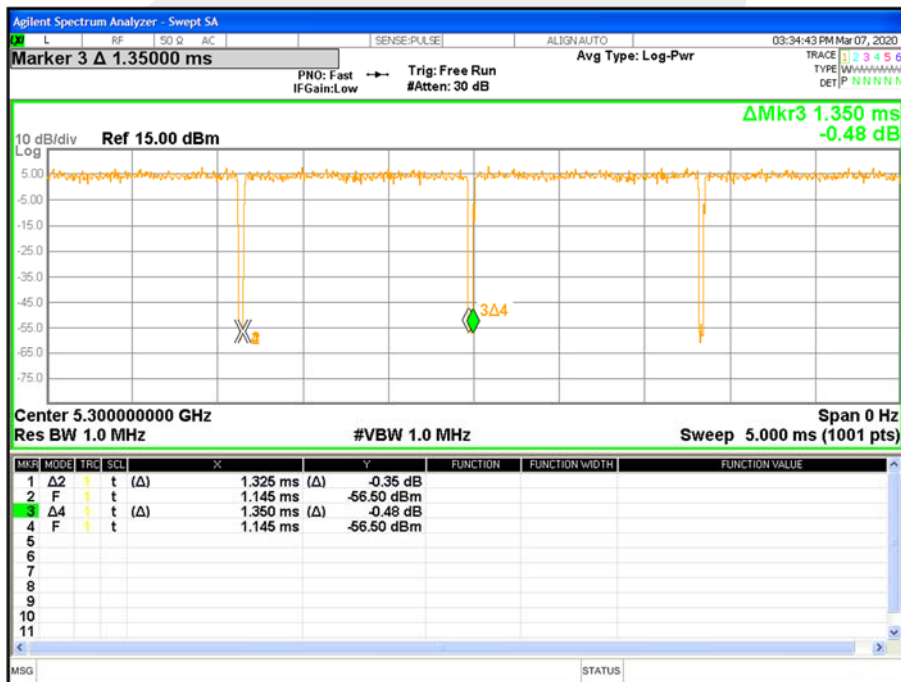



802.11ac(VHT40)



802.11ac(VHT80)





Band 4
802.11 a

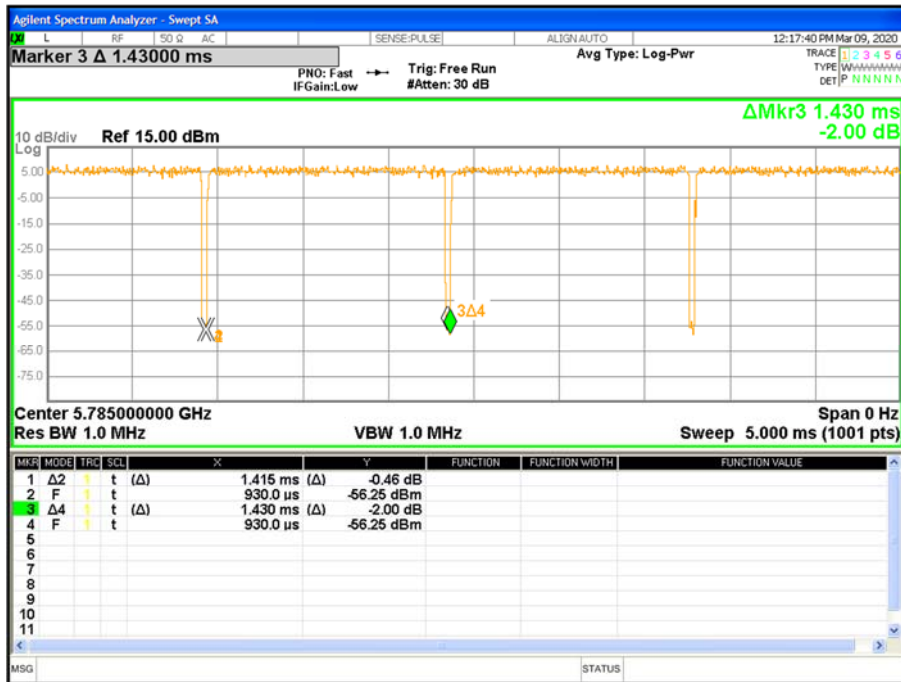

802.11n(HT20)

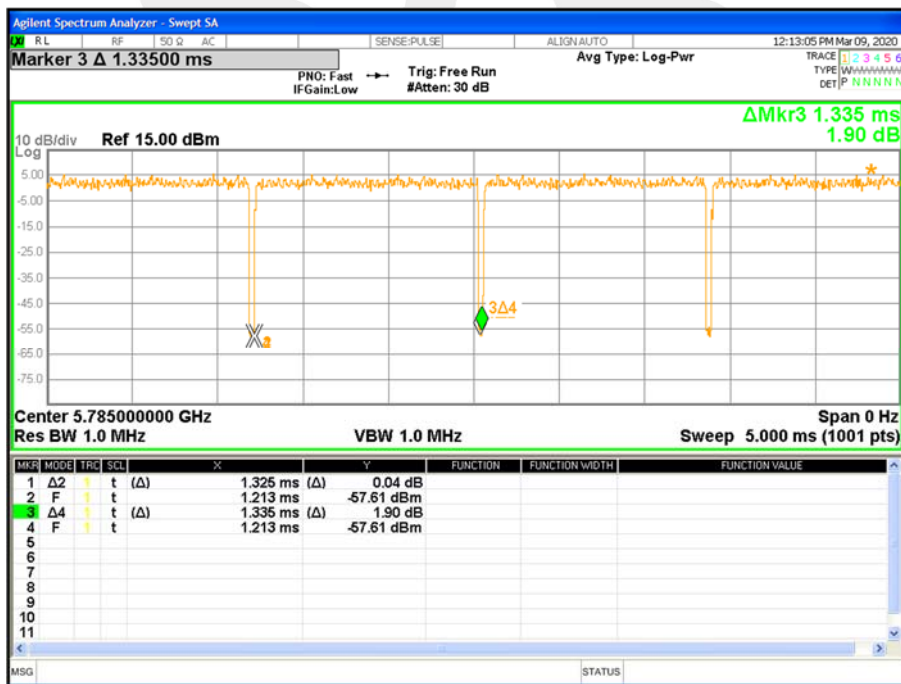



802.11n(HT40)

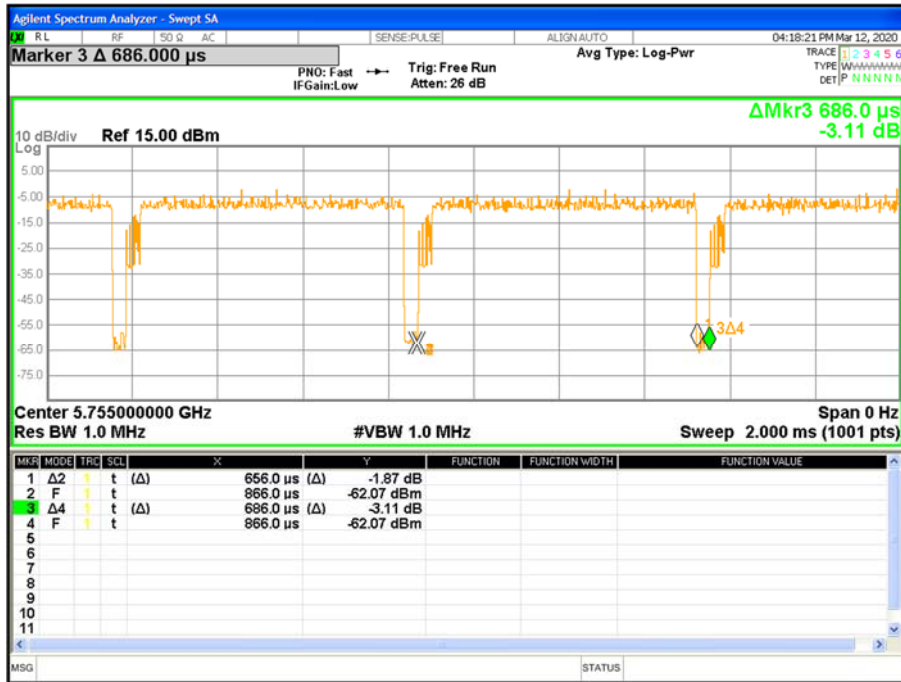

802.11ac(VHT20)

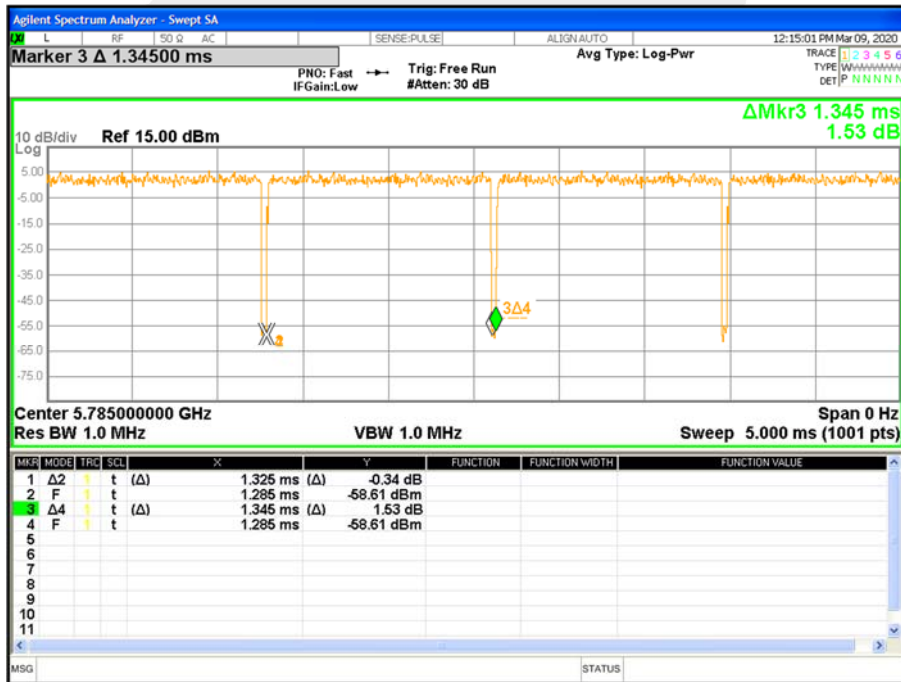



802.11ac(VHT40)



802.11ac(VHT80)



8. AUTOMATICALLY DISCONTINUE TRANSMISSION

8.1 LIMIT OF AUTOMATICALLY DISCONTINUE TRANSMISSION

The device shall automatically discontinue transmission in case of either absence of information to transmit or operational failure. These provisions are not intended to preclude the transmission of control or signaling information or the use of repetitive codes used by certain digital technologies to complete frame or burst intervals. Applicants shall include in their application for equipment authorization to describe how this requirement is met.

8.2 TEST RESULT OF AUTOMATICALLY DISCONTINUE TRANSMISSION

During no any information transmission, the EUT can automatically discontinue transmission and become standby mode for power saving. The EUT can detect the controlling signal of ACK message transmitting from remote device and verify whether it shall resend or discontinue transmission





9. ANTENNA REQUIREMENT

9.1 STANDARD REQUIREMENT

15.203 requirement: For intentional device, according to 15.203: an intentional radiator shall be designed to ensure that no antenna other than that furnished by the responsible party shall be used with the device.

9.2 EUT ANTENNA

The EUT antenna is PIFA Antenna. It comply with the standard requirement.





APPENDIX - PHOTOS OF TEST SETUP

Note: See test photos in setup photo document for the actual connections between Product and support equipment.

※※※※※END OF THE REPORT※※※※※

