



FCC Radio Test Report

FCC ID: 2ATPZJJ07632

Original Grant

Report No. : TB-FCC177499
Applicant : JAXJOX INC
Equipment Under Test (EUT)
EUT Name : InteractiveStudio
Model No. : JJ15003
Series Model No. : N/A
Brand Name : JAXJOX®
Sample ID : TBBJ-20200930-05-1#& TBBJ-20200930-05-2#
Receipt Date : 2020-10-15
Test Date : 2020-10-16 to 2020-12-03
Issue Date : 2020-12-03
Standards : FCC Part 15, Subpart C 15.247
Test Method : ANSI C63.10: 2013
Conclusions : **PASS**

In the configuration tested, the EUT complied with the standards specified above,
The EUT technically complies with the FCC and IC requirements

Test/Witness Engineer :  Seven Wu
Engineer Supervisor :  Ivan Su
Engineer Manager :  Ray Lai



This report details the results of the testing carried out on one sample. The results contained in this test report do not relate to other samples of the same product. The manufacturer should ensure that all products in series production are in conformity with the product sample detailed in the report.

Contents

CONTENTS.....2

1. GENERAL INFORMATION ABOUT EUT5

1.1 Client Information.....5

1.2 General Description of EUT (Equipment Under Test)5

1.3 Block Diagram Showing the Configuration of System Tested.....6

1.4 Description of Support Units6

1.5 Description of Test Mode.....7

1.6 Description of Test Software Setting8

1.7 Measurement Uncertainty9

1.8 Test Facility.....9

2. TEST SUMMARY 10

3. TEST SOFTWARE..... 10

4. TEST EQUIPMENT 11

5. CONDUCTED EMISSION TEST 12

5.1 Test Standard and Limit..... 12

5.2 Test Setup..... 12

5.3 Test Procedure..... 13

5.4 Deviation From Test Standard..... 13

5.5 EUT Operating Mode 13

5.6 Test Data..... 13

6. RADIATED EMISSION TEST 14

6.1 Test Standard and Limit..... 14

6.2 Test Setup..... 15

6.3 Test Procedure..... 16

6.4 Deviation From Test Standard..... 17

6.5 EUT Operating Condition 17

6.6 Test Data..... 17

7. RESTRICTED BANDS REQUIREMENT 18

7.1 Test Standard and Limit..... 18

7.2 Test Setup..... 18

7.3 Test Procedure..... 19

7.4 Deviation From Test Standard..... 19

7.5 EUT Operating Condition 19

7.6 Test Data..... 19

8. BANDWIDTH TEST 20

8.1 Test Standard and Limit..... 20

8.2 Test Setup..... 20

8.3 Test Procedure..... 20

8.4 Deviation From Test Standard..... 20

8.5 EUT Operating Condition	20
8.6 Test Data.....	20
9. PEAK OUTPUT POWER TEST.....	21
9.1 Test Standard and Limit.....	21
9.2 Test Setup.....	21
9.3 Test Procedure.....	21
9.4 Deviation From Test Standard.....	21
9.5 EUT Operating Condition	21
9.6 Test Data.....	21
10. POWER SPECTRAL DENSITY TEST	22
10.1 Test Standard and Limit	22
10.2 Test Setup.....	22
10.3 Test Procedure.....	22
10.4 Deviation From Test Standard.....	22
10.5 EUT Operating Condition	22
10.6 Test Data.....	22
11. ANTENNA REQUIREMENT.....	23
11.1 Standard Requirement.....	23
11.2 Deviation From Test Standard.....	23
11.3 Antenna Connected Construction.....	23
ATTACHMENT A-- CONDUCTED EMISSION TEST DATA	24
ATTACHMENT B-- RADIATED EMISSION TEST DATA	26
ATTACHMENT C-- RESTRICTED BANDS REQUIREMENT AND BAND-EDGE TEST DATA	40
ATTACHMENT D-- BANDWIDTH TEST DATA.....	60
ATTACHMENT E-- PEAK OUTPUT POWER TEST DATA.....	68
ATTACHMENT F-- POWER SPECTRAL DENSITY TEST DATA.....	71

1. General Information about EUT

1.1 Client Information

Applicant	:	JAXJOX INC
Address	:	Lincoln Square South Building 10400 NE 4th ST
Manufacturer	:	JAXJOX INC
Address	:	Lincoln Square South Building 10400 NE 4th ST

1.2 General Description of EUT (Equipment Under Test)

EUT Name	:	InteractiveStudio
Models No.	:	JJ15003
Model Different	:	----
Product Description	Operation Frequency:	802.11b/g/n(HT20): 2412MHz~2462MHz 802.11n(HT40): 2422MHz~2452MHz
	Number of Channel:	802.11b/g/n(HT20):11 channels <i>see note(3)</i> 802.11n(HT40):7 channels <i>see note(3)</i>
	RF Output Power:	802.11b:15.03dBm 802.11g: 14.02dBm 802.11n (HT20): 13.436dBm 802.11n (HT40): 12.189dBm
	Antenna Gain:	2 dBi PCB Antenna
	Modulation Type:	802.11b: DSSS(CCK, DQPSK, DBPSK) 802.11g/n:OFDM(BPSK,QPSK,16QAM,64QAM)
	Bit Rate of Transmitter:	802.11b:11/5.5/2/1 Mbps 802.11g:54/48/36/24/18/12/9/6 Mbps 802.11n:up to 150Mbps
	Power Rating	:
Software Version	:	11291517_r2087
Hardware Version	:	EDU.MS848.9

Note:

- (1) This Test Report is FCC Part 15.247 for 802.11b/g/n, the test procedure follows the FCC KDB 558074 D01 v05r02 and KDB 662911 D01 Multiple Transmitter Output v02r01.
- (2) For a more detailed features description, please refer to the manufacturer's specifications or the User's Manual.

(3) Channel List:

Channel	Frequency (MHz)	Channel	Frequency (MHz)	Channel	Frequency (MHz)
01	2412	05	2432	09	2452
02	2417	06	2437	10	2457
03	2422	07	2442	11	2462
04	2427	08	2447		

Note: CH 01~CH 11 for 802.11b/g/n(HT20)
CH 03~CH 09 for 802.11n(HT40)

(4) The Antenna information about the equipment is provided by the applicant.

1.3 Block Diagram Showing the Configuration of System Tested

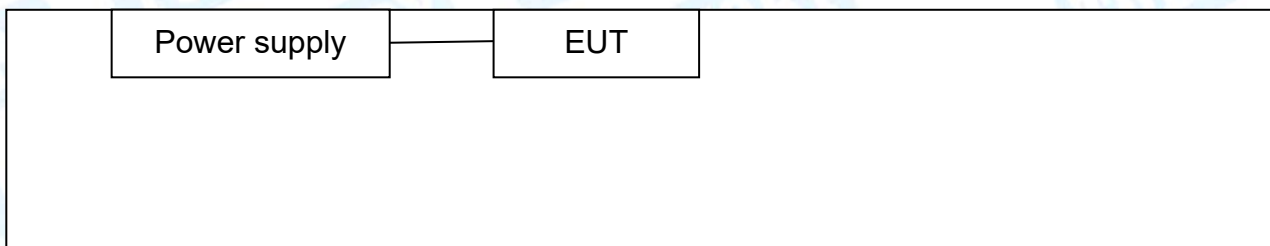

1.4 Description of Support Units

The EUT has been test as an independent unit.

1.5 Description of Test Mode

To investigate the maximum EMI emission characteristics generates from EUT, the test system was pre-scanning tested base on the consideration of following EUT operation mode or test configuration mode which possible have effect on EMI emission level. Each of these EUT operation mode(s) or test configuration mode(s) mentioned follow was evaluated respectively.

For Conducted Test	
Final Test Mode	Description
Mode 1	Power supply+TX B Mode
For Radiated and RF Conducted Test	
Final Test Mode	Description
Mode 2	TX Mode B Mode Channel 01/06/11
Mode 3	TX Mode G Mode Channel 01/06/11
Mode 4	TX Mode N(HT20) Mode Channel 01/06/11
Mode 5	TX Mode N(HT40) Mode Channel 01/06/11
Note : The antenna gain provided by the applicant, the verified for the RF conduction test provided by TOBY test lab.	

Note:

- (1) For all test, we have verified the construction and function in typical operation. And all the test modes were carried out with the EUT in transmitting operation in maximum power with all kinds of data rate.
According to ANSI C63.10 standards, the measurements are performed at the highest, Middle, lowest available channels, and the worst case data rate as follows:
 - 802.11b Mode: CCK (1 Mbps)
 - 802.11g Mode: OFDM (6 Mbps)
 - 802.11n (HT20) Mode: MCS 0 (6.5 Mbps)
 - 802.11n (HT40) Mode: MCS 0 (30 Mbps)
- (2) During the testing procedure, the continuously transmitting with the maximum power mode was programmed by the customer.
- (3) The EUT is considered a Mobile device; in normal use it was positioned on X-plane. The worst case was found positioned on X-plane. Therefore only the test data of this X-plane was used for radiated emission measurement test.

1.6 Description of Test Software Setting

During testing channel & Power controlling software provided by the customer was used to control the operating channel as well as the output power level. The RF output power selection is for the setting of RF output power expected by the customer and is going to be fixed on the firmware of the final end product power parameters of WLAN.

Test Software: UI_mptool			
Test Mode: Continuously transmitting			
Mode	Data Rate	Channel	Parameters
802.11b	CCK/ 1Mbps	01	30
	CCK/ 1Mbps	06	30
	CCK/ 1Mbps	11	30
802.11g	OFDM/ 6Mbps	01	36
	OFDM/ 6Mbps	06	36
	OFDM/ 6Mbps	11	36
802.11n(HT20)	MCS 0	01	36
	MCS 0	06	36
	MCS 0	11	36
802.11n(HT40)	MCS 0	03	38
	MCS 0	06	38
	MCS 0	09	38

1.7 Measurement Uncertainty

The reported uncertainty of measurement $y \pm U$, where expanded uncertainty U is based on a standard uncertainty multiplied by a coverage factor of $k=2$, providing a level of confidence of approximately 95 %.

Test Item	Parameters	Expanded Uncertainty (U_{Lab})
Conducted Emission	Level Accuracy: 9kHz~150kHz 150kHz to 30MHz	± 3.50 dB ± 3.10 dB
Radiated Emission	Level Accuracy: 9kHz to 30 MHz	± 4.60 dB
Radiated Emission	Level Accuracy: 30MHz to 1000 MHz	± 4.50 dB
Radiated Emission	Level Accuracy: Above 1000MHz	± 4.20 dB

1.8 Test Facility

The testing was performed by the Shenzhen Toby Technology Co., Ltd., in their facilities located at:1A/F., Bldg.6, Yusheng Industrial Zone, The National Road No.107 Xixiang Section 467, Xixiang, Bao'an, Shenzhen, Guangdong, China.

At the time of testing, the following bodies accredited the Laboratory:

CNAS (L5813)

The Laboratory has been accredited by CNAS to ISO/IEC 17025: 2005 General Requirements for the Competence of Testing and Calibration Laboratories for the competence in the field of testing. And the Registration No.: CNAS L5813.

A2LA Certificate No.: 4750.01

The laboratory has been accredited by American Association for Laboratory Accreditation(A2LA) to ISO/IEC 17025: 2005 General Requirements for the Competence of Testing and Calibration Laboratories for the technical competence in the field of Electrical Testing. And the A2LA Certificate No.: 4750.01.FCC Accredited Test Site Number: 854351.

IC Registration No.: (11950A)

The Laboratory has been registered by Certification and Engineering Bureau of Industry Canada for radio equipment testing. The site registration: Site# 11950A.

2. Test Summary

FCC Part 15 Subpart C(15.247)				
Standard Section	Test Item	Test Sample(s)	Judgment	Remark
FCC				
15.203	Antenna Requirement	TBBJ-20200930-05-2#	PASS	N/A
15.207	Conducted Emission	TBBJ-20200930-05-1#	PASS	N/A
15.205	Restricted Bands	TBBJ-20200930-05-2#	PASS	N/A
15.247(a)(2)	6dB Bandwidth	TBBJ-20200930-05-2#	PASS	N/A
15.247(b)	Peak Output Power	TBBJ-20200930-05-2#	PASS	N/A
15.247(e)	Power Spectral Density	TBBJ-20200930-05-2#	PASS	N/A
15.247(d)	Band Edge	TBBJ-20200930-05-2#	PASS	N/A
15.247(d)&15.209	Transmitter Spurious Emission	TBBJ-20200930-05-2#	PASS	N/A

Note: “/” for no requirement for this test item.
N/A is an abbreviation for Not Applicable.

3. Test Software

Test Item	Test Software	Manufacturer	Version No.
Conducted Emission	EZ-EMC	EZ	CDI-03A2
Radiation Emission	EZ-EMC	EZ	FA-03A2RE
RF Conducted Measurement	MTS-8310	MWRfTest	V2.0.0.0

4. Test Equipment

Conducted Emission Test					
Equipment	Manufacturer	Model No.	Serial No.	Last Cal.	Cal. Due Date
EMI Test Receiver	Rohde & Schwarz	ESCI	100321	Jul. 06, 2020	Jul. 05, 2021
RF Switching Unit	Compliance Direction Systems Inc	RSU-A4	34403	Jul. 06, 2020	Jul. 05, 2021
AMN	SCHWARZBECK	NNBL 8226-2	8226-2/164	Jul. 06, 2020	Jul. 05, 2021
LISN	Rohde & Schwarz	ENV216	101131	Jul. 06, 2020	Jul. 05, 2021
Radiation Emission Test					
Equipment	Manufacturer	Model No.	Serial No.	Last Cal.	Cal. Due Date
Spectrum Analyzer	Agilent	E4407B	MY45106456	Jul. 06, 2020	Jul. 05, 2021
EMI Test Receiver	Rohde & Schwarz	ESPI	100010/007	Jul. 06, 2020	Jul. 05, 2021
Spectrum Analyzer	Rohde & Schwarz	FSV40-N	102197	Jul. 06, 2020	Jul. 05, 2021
Bilog Antenna	ETS-LINDGREN	3142E	00117537	Mar.01, 2020	Feb. 28, 2022
Horn Antenna	ETS-LINDGREN	3117	00143207	Mar.01, 2020	Feb. 28, 2022
Horn Antenna	ETS-LINDGREN	BBHA 9170	BBHA9170582	Mar.01, 2020	Feb. 28, 2022
Loop Antenna	SCHWARZBECK	FMZB 1519 B	1519B-059	Jul. 07, 2020	Jul. 06, 2021
Pre-amplifier	Sonoma	310N	185903	Mar.01, 2020	Feb. 28, 2021
Pre-amplifier	HP	8449B	3008A00849	Mar.01, 2020	Feb. 28, 2021
Pre-amplifier	SKET	LNPA_1840G-50	SK201904032	Mar.01, 2020	Feb. 28, 2021
Cable	HUBER+SUHNER	100	SUCOFLEX	Mar.01, 2020	Feb. 28, 2021
Positioning Controller	ETS-LINDGREN	2090	N/A	N/A	N/A
Antenna Conducted Emission					
Equipment	Manufacturer	Model No.	Serial No.	Last Cal.	Cal. Due Date
Spectrum Analyzer	Agilent	E4407B	MY45106456	Jul. 06, 2020	Jul. 05, 2021
Spectrum Analyzer	Rohde & Schwarz	ESPI	100010/007	Jul. 06, 2020	Jul. 05, 2021
MXA Signal Analyzer	Agilent	N9020A	MY49100060	Sep. 11, 2020	Sep. 10, 2021
Vector Signal Generator	Agilent	N5182A	MY50141294	Sep. 11, 2020	Sep. 10, 2021
Analog Signal Generator	Agilent	N5181A	MY50141953	Sep. 11, 2020	Sep. 10, 2021
RF Power Sensor	DARE!! Instruments	RadiPowerRPR3006W	17100015SNO26	Sep. 11, 2020	Sep. 10, 2021
	DARE!! Instruments	RadiPowerRPR3006W	17100015SNO29	Sep. 11, 2020	Sep. 10, 2021
	DARE!! Instruments	RadiPowerRPR3006W	17100015SNO31	Sep. 11, 2020	Sep. 10, 2021
	DARE!! Instruments	RadiPowerRPR3006W	17100015SNO33	Sep. 11, 2020	Sep. 10, 2021

5. Conducted Emission Test

5.1 Test Standard and Limit

5.1.1 Test Standard

FCC Part 15.207

5.1.2 Test Limit

Conducted Emission Test Limit

Frequency	Maximum RF Line Voltage (dB μ V)	
	Quasi-peak Level	Average Level
150kHz~500kHz	66 ~ 56 *	56 ~ 46 *
500kHz~5MHz	56	46
5MHz~30MHz	60	50

Notes:

- (1) *Decreasing linearly with logarithm of the frequency.
- (2) The lower limit shall apply at the transition frequencies.
- (3) The limit decrease in line with the logarithm of the frequency in the range of 0.15 to 0.50MHz.

5.2 Test Setup

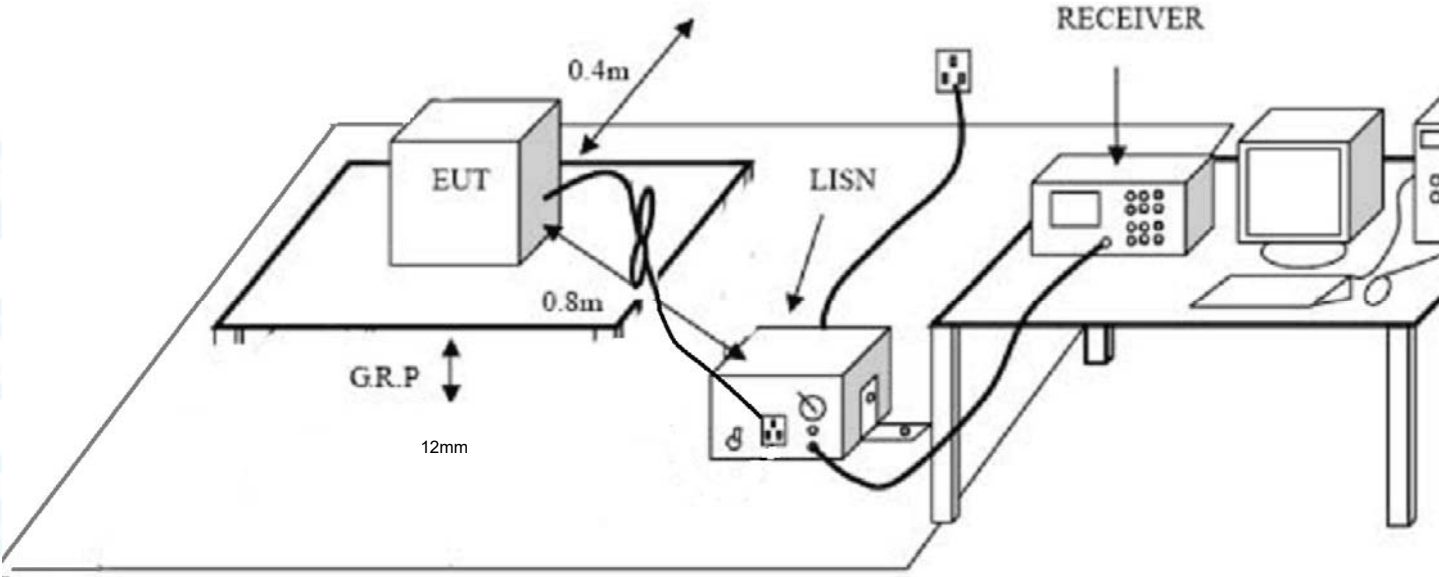

5.3 Test Procedure

- (1) The EUT was placed 12mm meters from the horizontal ground plane with EUT being connected to the power mains through a line impedance stabilization network (LISN). All other support equipments powered from additional LISN(s). The LISN provide 50 Ohm/ 50uH of coupling impedance for the measuring instrument.
- (2) Interconnecting cables that hang closer than 40 cm to the ground plane shall be folded back and forth in the center forming a bundle 30 to 40 cm long.
- (3) I/O cables that are not connected to a peripheral shall be bundled in the center. The end of the cable may be terminated, if required, using the correct terminating impedance. The overall length shall not exceed 1 m.
- (4) LISN at least 80 cm from nearest part of EUT chassis.
- (5) The bandwidth of EMI test receiver is set at 9kHz, and the test frequency band is from 0.15MHz to 30MHz.

5.4 Deviation From Test Standard

No deviation

5.5 EUT Operating Mode

Please refer to the description of test mode.

5.6 Test Data

Please refer to the Attachment A.

6. Radiated Emission Test

6.1 Test Standard and Limit

6.1.1 Test Standard

FCC Part 15.209

6.1.2 Test Limit

Radiated Emission Limits (9 kHz~1000 MHz)

Frequency (MHz)	Field Strength (microvolt/meter)	Measurement Distance (meters)
0.009~0.490	2400/F(KHz)	300
0.490~1.705	24000/F(KHz)	30
1.705~30.0	30	30
30~88	100	3
88~216	150	3
216~960	200	3
Above 960	500	3

Radiated Emission Limit (Above 1000MHz)

Frequency (MHz)	Distance of 3m (dBuV/m)	
	Peak	Average
Above 1000	74	54

Note:

- (1) The tighter limit applies at the band edges.
- (2) Emission Level(dBuV/m)=20log Emission Level(uV/m)

6.2 Test Setup

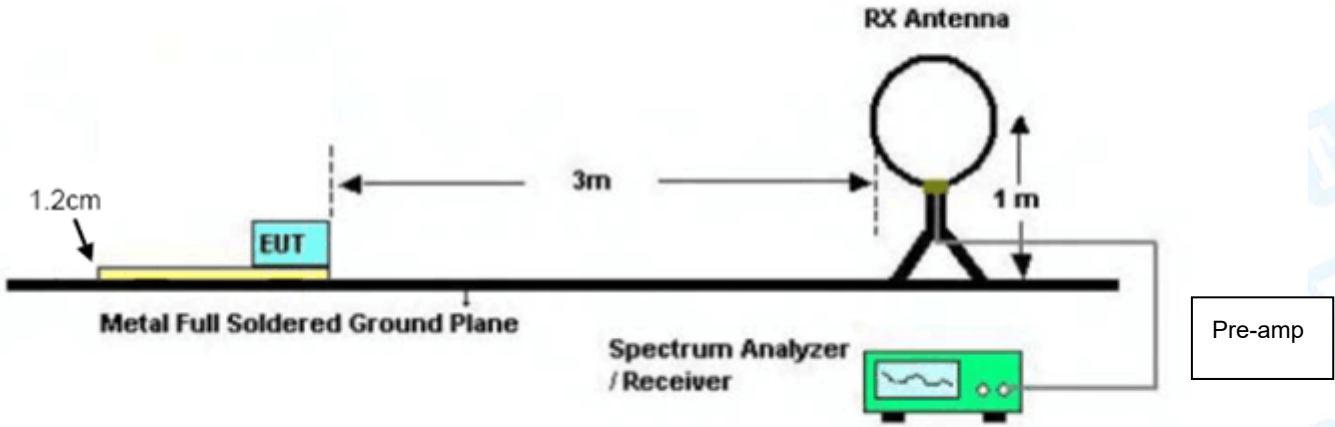

Below 30MHz Test Setup

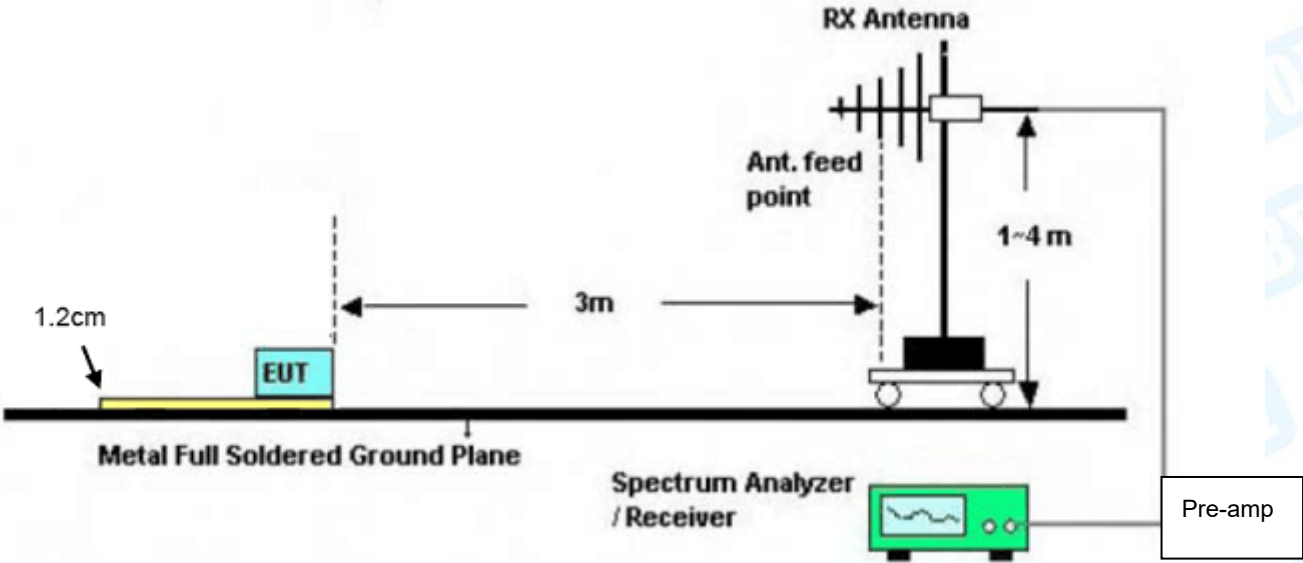

Below 1000MHz Test Setup

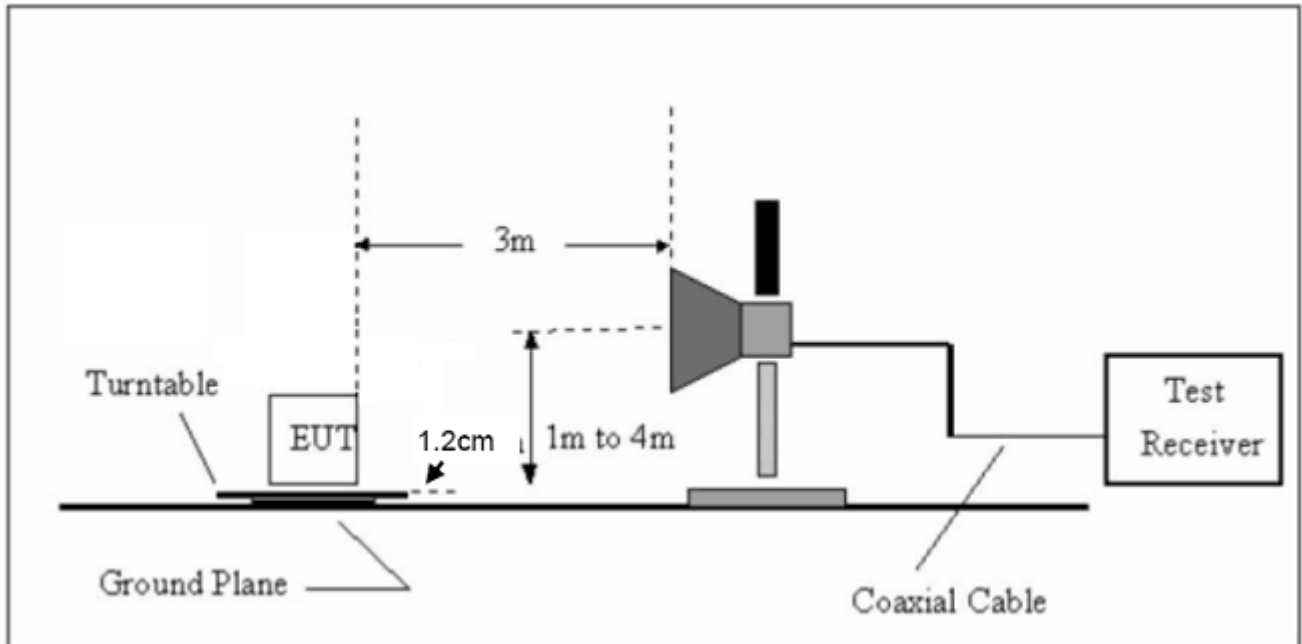

Above 1GHz Test Setup

6.3 Test Procedure

- (1) Measurements at frequency above 1GHz. The EUT was placed on a rotating 1.5m high above the ground. RF absorbers covered the ground plane with a minimum area of 3.0m by 3.0m between the EUT and measurement receiver antenna. The RF absorber shall not exceed 30cm in high above the conducting floor. The table was rotated 360 degrees to determine the position of the highest radiation.
- (2) Measurements at frequency Below 1GHz. The EUT was placed on a rotating 12mm high above the ground. RF absorbers covered the ground plane with a minimum area of 3.0m by 3.0m between the EUT and measurement receiver antenna. The RF absorber shall not exceed 30cm in high above the conducting floor. The table was rotated 360 degrees to determine the position of the highest radiation.
- (3) The Test antenna shall vary between 1m and 4m, Both Horizontal and Vertical antenna are set to make measurement.
- (4) The initial step in collecting conducted emission data is a spectrum analyzer peak detector mode pre-scanning the measurement frequency range. Significant peaks are then marked and then Quasi Peak detector mode re-measured.

- (5) If the Peak Mode measured value compliance with and lower than Quasi Peak Mode Limit Bellow 1 GHz, the EUT shall be deemed to meet QP Limits and then no additional QP Mode measurement performed. But the Peak Value and average value both need to comply with applicable limit above 1 GHz.
- (6) Testing frequency range below 1GHz the measuring instrument use VBW=120 kHz with Quasi-peak detection.
- (7) Testing frequency range above 1GHz the measuring instrument use RBW=1 MHz and VBW=3 MHz with Peak Detector for Peak Values, and use RBW=1 MHz and VBW=10 Hz with Peak Detector for Average Values.
- (8) For the actual test configuration, please see the test setup photo.

6.4 Deviation From Test Standard

No deviation

6.5 EUT Operating Condition

The Equipment Under Test was set to Continual Transmitting in maximum power.

6.6 Test Data

Remark: During testing above 1GHz the measuring instrument use RBW=1 MHz and VBW=3 MHz with Peak Detector for Peak Values, and use RBW=1 MHz and VBW=10 Hz with Peak Detector for Average Values.

Please refer to the Attachment B.

7. Restricted Bands Requirement

7.1 Test Standard and Limit

7.1.1 Test Standard

FCC Part 15.247(d)
FCC Part 15.209
FCC Part 15.205

7.1.2 Test Limit

Restricted Frequency Band (MHz)	Distance of 3m (dBuV/m)	
	Peak	Average
2310 ~2390	74	54
2483.5 ~2500	74	54

7.2 Test Setup

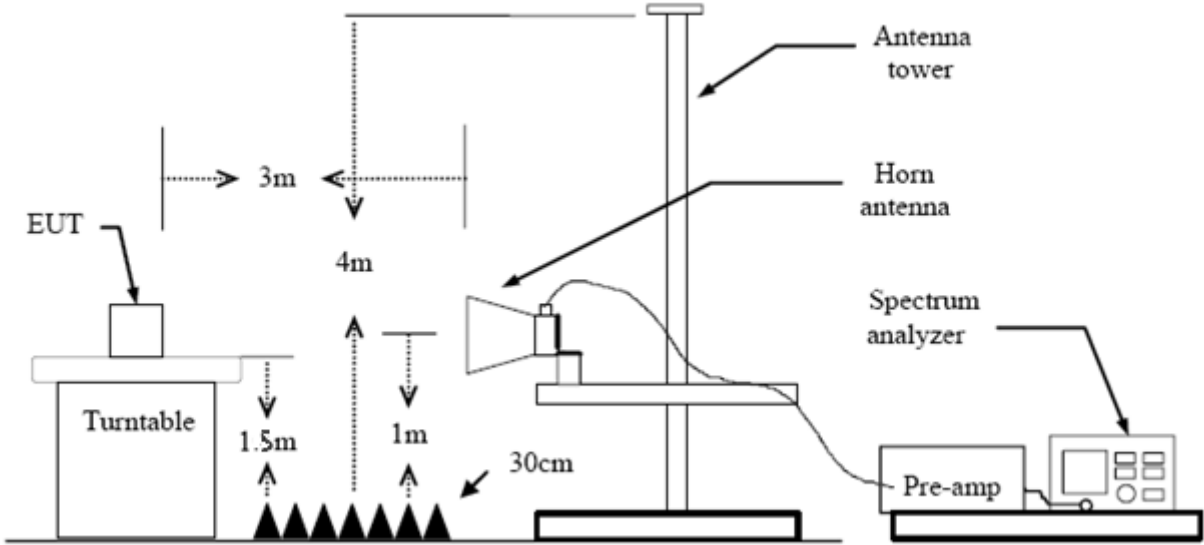

7.3 Test Procedure

- (1) The measuring distance of 3m shall be used for measurements at frequency Below 1GHz and above 1 GHz. The EUT was placed on a rotating 12mm high above ground, the table was rotated 360 degrees to determine the position of the highest radiation.
- (2) Measurements at frequency above 1GHz. The EUT was placed on a rotating 1.5m high above the ground. RF absorbers covered the ground plane with a minimum area of 3.0m by 3.0m between the EUT and measurement receiver antenna. The RF absorber shall not exceed 30cm in high above the conducting floor. The table was rotated 360 degrees to determine the position of the highest radiation.
- (3) The Test antenna shall vary between 1m and 4m, Both Horizontal and Vertical antenna are set to make measurement.
- (4) The initial step in collecting conducted emission data is a spectrum analyzer peak detector mode pre-scanning the measurement frequency range. Significant peaks are then marked and then Quasi Peak detector mode re-measured.
- (5) If the Peak Mode measured value compliance with and lower than Quasi Peak Mode Limit Bellow 1 GHz, the EUT shall be deemed to meet QP Limits and then no additional QP Mode measurement performed. But the Peak Value and average value both need to comply with applicable limit above 1 GHz.
- (6) Testing frequency range below 1GHz the measuring instrument use VBW=120 kHz with Quasi-peak detection.
- (7) Testing frequency range above 1GHz the measuring instrument use RBW=1 MHz and VBW=3 MHz with Peak Detector for Peak Values, and use RBW=1 MHz and VBW=10 Hz with Peak Detector for Average Values.
- (8) For the actual test configuration, please see the test setup photo.

7.4 Deviation From Test Standard

No deviation

7.5 EUT Operating Condition

The Equipment Under Test was set to Continual Transmitting in maximum power.

7.6 Test Data

Please refer to the Attachment C.

8. Bandwidth Test

8.1 Test Standard and Limit

8.1.1 Test Standard

FCC Part 15.247 (a)(2)

8.1.2 Test Limit

FCC Part 15 Subpart C(15.247)		
Test Item	Limit	Frequency Range(MHz)
Bandwidth	≥ 500 KHz (6dB bandwidth)	2400~2483.5

8.2 Test Setup

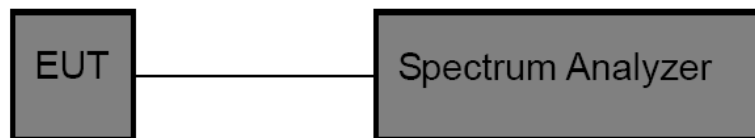

8.3 Test Procedure

- (1) The EUT was directly connected to the spectrum analyzer and antenna output port as show in the block diagram above.
- (2) The bandwidth is measured at an amplitude level reduced 6dB from the reference level. The reference level is the level of the highest amplitude signal observed from the transmitter at the fundamental frequency. Once the reference level is established, the equipment is conditioned with typical modulating signal to produce the worst –case (i.e the widest) bandwidth.
- (3) Measure the channel separation the spectrum analyzer was set to Resolution Bandwidth:100 kHz, and Video Bandwidth:300 kHz, Detector: Peak, Sweep Time set auto.

8.4 Deviation From Test Standard

No deviation

8.5 EUT Operating Condition

The EUT was set to continuously transmitting in each mode and low, Middle and high channel for the test.

8.6 Test Data

Please refer to the Attachment D.

9. Peak Output Power Test

9.1 Test Standard and Limit

9.1.1 Test Standard

FCC Part 15.247 (b)

9.1.2 Test Limit

FCC Part 15 Subpart C(15.247)		
Test Item	Limit	Frequency Range(MHz)
Peak Output Power	1 Watt or 30 dBm	2400~2483.5

9.2 Test Setup

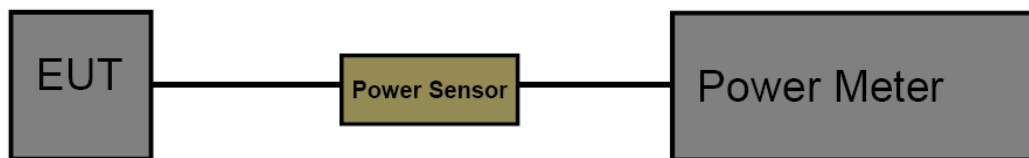

9.3 Test Procedure

The measurement is according to section 9.1.2 of KDB 558074 D01 v05r02.

The EUT was connected to RF power meter via a broadband power sensor as show the block above. The power sensor video bandwidth is greater than or equal to the DTS bandwidth of the equipment.

9.4 Deviation From Test Standard

No deviation

9.5 EUT Operating Condition

The EUT was set to continuously transmitting in the max power during the test.

9.6 Test Data

Please refer to the Attachment E.

10. Power Spectral Density Test

10.1 Test Standard and Limit

10.1.1 Test Standard

FCC Part 15.247 (e)

10.1.2 Test Limit

FCC Part 15 Subpart C(15.247)		
Test Item	Limit	Frequency Range(MHz)
Power Spectral Density	8dBm(in any 3 kHz)	2400~2483.5

10.2 Test Setup

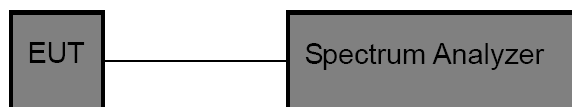

10.3 Test Procedure

The EUT was directly connected to the Spectrum Analyzer and antenna output port as show in the block diagram above. The measurement according to section 10.2 of KDB 558074 D01 D01 v05r02.

- (1) The EUT was directly connected to the spectrum analyzer and antenna output port as show in the block diagram above.
- (2) Set analyser centre frequency to DTS channel centre frequency.
- (3) Set the span to 1.5 times the DTS bandwidth.
- (4) Set the RBW to: 3 kHz
- (5) Set the VBW to: 10 kHz
- (6) Detector: peak
- (7) Sweep time: auto
- (8) Allow trace to fully stabilize. Then use the peak marker function to determine the maximum amplitude level.

10.4 Deviation From Test Standard

No deviation

10.5 EUT Operating Condition

The EUT was set to continuously transmitting in each mode and low, Middle and high channel for the test.

10.6 Test Data

Please refer to the Attachment F.

11. Antenna Requirement

11.1 Standard Requirement

11.1.1 Standard

FCC Part 15.203

11.1.2 Requirement

An intentional radiator shall be designed to ensure that no antenna other than that furnished by the responsible party shall be used with the device. The use of a permanently attached antenna or of an antenna that uses a unique coupling to the intentional radiator shall be considered sufficient to comply with the provisions of this Section. The manufacturer may design the unit so that a broken antenna can be replaced by the user, but the use of a standard antenna jack or electrical connector is prohibited.

11.2 Deviation From Test Standard

No deviation

11.3 Antenna Connected Construction

The gains of the antenna used for transmitting is 2 dBi, and the antenna de-signed with permanent attachment and no consideration of replacement. Please see the EUT photo for details.

Result

The EUT antenna is a PCB Antenna. It complies with the standard requirement.

Antenna Type
<input checked="" type="checkbox"/> Permanent attached antenna
<input type="checkbox"/> Unique connector antenna
<input type="checkbox"/> Professional installation antenna

Attachment A-- Conducted Emission Test Data

Remark: All channels have been tested and Shows only the worst channels.

Temperature:	24.5°C	Relative Humidity:	44%
Test Voltage:	AC 120V/60Hz		
Terminal:	Line		
Test Mode:	Mode 1		
Remark:	Only worst case is reported		

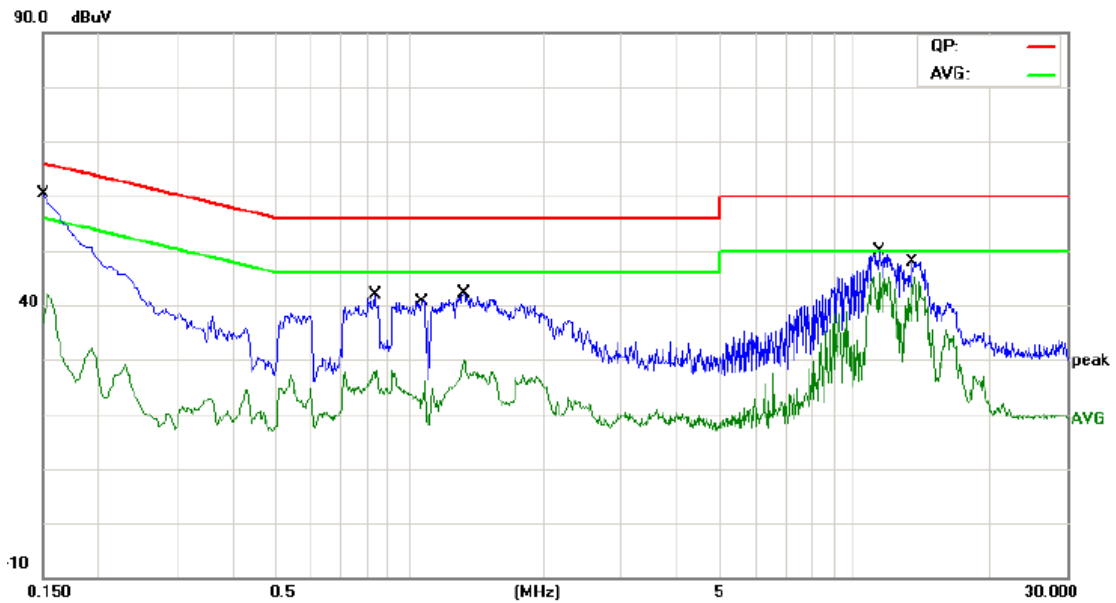

No.	Mk.	Freq. MHz	Reading Level dBuV	Correct Factor dB	Measure- ment dBuV	Limit dBuV	Over dB	Detector
1		0.1500	44.95	9.80	54.75	65.99	-11.24	QP
2		0.1500	29.06	9.80	38.86	55.99	-17.13	AVG
3		0.8380	27.67	9.80	37.47	56.00	-18.53	QP
4		0.8380	17.25	9.80	27.05	46.00	-18.95	AVG
5		1.0660	27.15	9.80	36.95	56.00	-19.05	QP
6		1.0660	11.61	9.80	21.41	46.00	-24.59	AVG
7		1.3260	28.85	9.80	38.65	56.00	-17.35	QP
8		1.3260	18.73	9.80	28.53	46.00	-17.47	AVG
9		11.3660	36.05	9.93	45.98	60.00	-14.02	QP
10	*	11.3660	30.47	9.93	40.40	50.00	-9.60	AVG
11		13.4820	34.56	9.97	44.53	60.00	-15.47	QP
12		13.4820	27.31	9.97	37.28	50.00	-12.72	AVG

Remark:

1. Corr. Factor (dB) = LISN Factor (dB) + Cable Loss (dB)
2. Margin (dB) = QuasiPeak/Average (dBuV) - Limit (dBuV)

Temperature:	24.5°C	Relative Humidity:	44%
Test Voltage:	AC 120V/60Hz		
Terminal:	Neutral		
Test Mode:	Mode 1		
Remark:	Only worst case is reported		

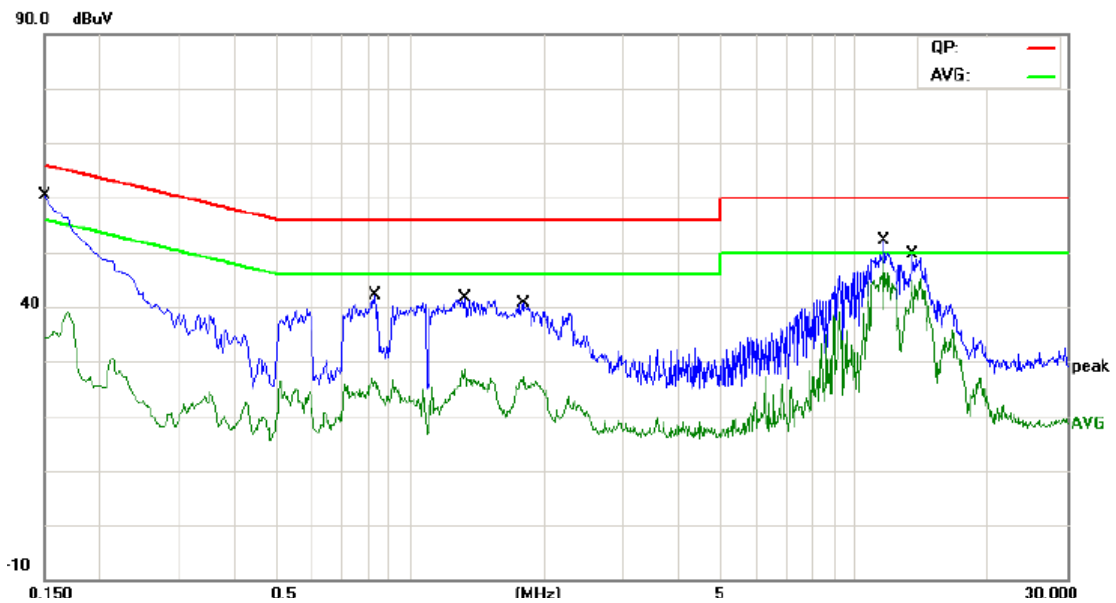

No.	Mk.	Freq. MHz	Reading Level dBuV	Correct Factor dB	Measure- ment dBuV	Limit dBuV	Over dB	Detector
1		0.1500	45.09	9.80	54.89	65.99	-11.10	QP
2		0.1500	29.46	9.80	39.26	55.99	-16.73	AVG
3		0.8340	28.36	9.80	38.16	56.00	-17.84	QP
4		0.8340	17.08	9.80	26.88	46.00	-19.12	AVG
5		1.3260	28.48	9.80	38.28	56.00	-17.72	QP
6		1.3260	18.06	9.80	27.86	46.00	-18.14	AVG
7		1.7980	26.76	9.80	36.56	56.00	-19.44	QP
8		1.7980	16.18	9.80	25.98	46.00	-20.02	AVG
9		11.6620	39.91	9.93	49.84	60.00	-10.16	QP
10	*	11.6620	34.28	9.93	44.21	50.00	-5.79	AVG
11		13.4940	34.91	9.97	44.88	60.00	-15.12	QP
12		13.4940	29.79	9.97	39.76	50.00	-10.24	AVG

Remark:

1. Corr. Factor (dB) = LISN Factor (dB) + Cable Loss (dB)
2. Margin (dB) = QuasiPeak/Average (dBuV) - Limit (dBuV)

Attachment B-- Radiated Emission Test Data

9KHz~30MHz

From 9KHz to 30MHz: Conclusion: PASS

Note: The amplitude of spurious emissions which are attenuated by more than 20dB below the permissible value has no need to be reported.

30MHz~1GHz

Temperature:	23.6°C	Relative Humidity:	44%
Test Voltage:	AC 120V/60HZ		
Ant. Pol.	Horizontal		
Test Mode:	TX B Mode 2412MHz		
Remark:	Only worst case is reported.		

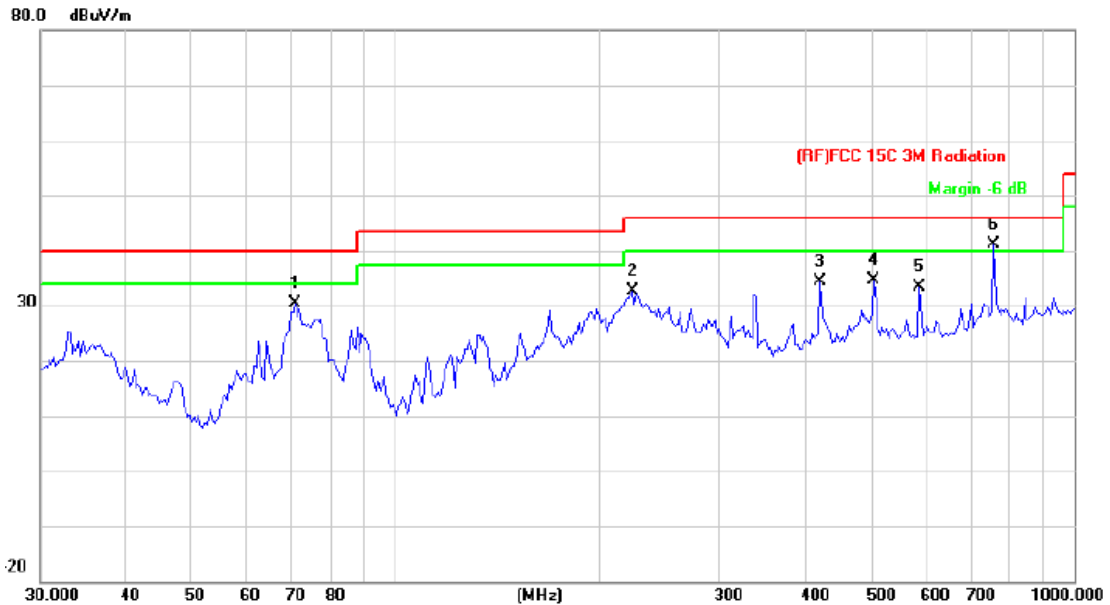

No.	Mk.	Freq.	Reading Level	Correct Factor	Measurement	Limit	Over	Detector
		MHz	dBuV	dB/m	dBuV/m	dBuV/m	dB	
1		71.0803	53.57	-23.29	30.28	40.00	-9.72	peak
2		222.9502	51.33	-18.70	32.63	46.00	-13.37	peak
3		422.0577	46.45	-12.13	34.32	46.00	-11.68	peak
4		506.4791	44.91	-10.28	34.63	46.00	-11.37	peak
5		590.9737	41.74	-8.42	33.32	46.00	-12.68	peak
6	*	760.7036	47.46	-6.40	41.06	46.00	-4.94	peak

*:Maximum data x:Over limit !:over margin

Remark:

1. Corr. = Antenna Factor (dB/m) + Cable Loss (dB)
2. QuasiPeak (dBμV/m)= Corr. (dB/m)+ Read Level (dBμV)
3. Margin (dB) = QuasiPeak (dBμV/m)-Limit QPK(dBμV/m)

Temperature:	23.6°C	Relative Humidity:	44%
Test Voltage:	AC 120V/60HZ		
Ant. Pol.	Vertical		
Test Mode:	TX B Mode 2412MHZ		
Remark:	Only worst case is reported.		

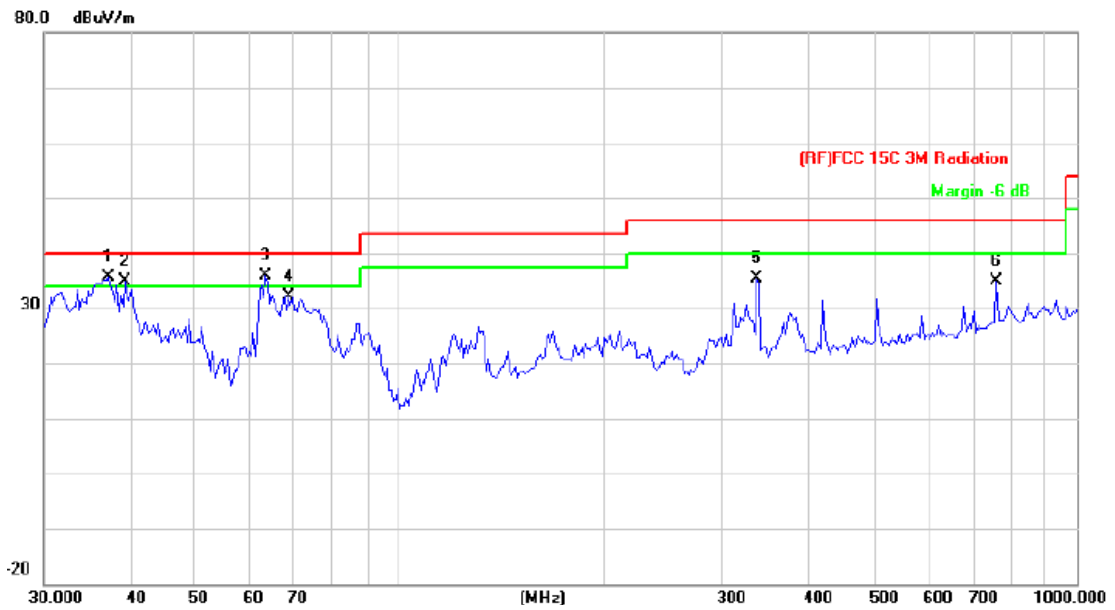

No.	Mk.	Freq. MHz	Reading Level dBuV	Correct Factor dB/m	Measure- ment dBuV/m	Limit dBuV/m	Over dB	Detector
1	!	37.2855	53.26	-17.74	35.52	40.00	-4.48	peak
2	!	39.4371	53.60	-18.73	34.87	40.00	-5.13	peak
3	*	63.5356	59.89	-23.92	35.97	40.00	-4.03	peak
4		68.6310	55.74	-23.51	32.23	40.00	-7.77	peak
5		337.2155	50.51	-15.05	35.46	46.00	-10.54	peak
6		760.7036	41.36	-6.40	34.96	46.00	-11.04	peak

*:Maximum data x:Over limit !:over margin

Remark:

1. Corr. = Antenna Factor (dB/m) + Cable Loss (dB)
2. QuasiPeak (dBμV/m)= Corr. (dB/m)+ Read Level (dBμV)
3. Margin (dB) = QuasiPeak (dBμV/m)-Limit QPK(dBμV/m)

Above 1GHz

Temperature:	23.7°C	Relative Humidity:	43%
Test Voltage:	AC 120V/60 Hz		
Ant. Pol.	Horizontal		
Test Mode:	TX B Mode 2412MHz		
Remark:	No report for the emission which more than 10dB below the prescribed limit.		

No.	Mk.	Freq.	Reading Level	Correct Factor	Measurement	Limit	Over	Detector
		MHz	dBuV	dB/m	dBuV/m	dBuV/m	dB	
1		4824.000	49.78	12.54	62.32	74.00	-11.68	peak
2	*	4824.000	32.97	12.54	45.51	54.00	-8.49	AVG

Remark:

1. Corr. = Antenna Factor (dB/m) + Cable Loss (dB)
2. Peak/AVG (dBuV/m)= Corr. (dB/m)+ Read Level (dBuV)
3. Margin (dB) = Peak/AVG (dBuV/m)-Limit PK/AVG(dBuV/m)

Temperature:	23.7°C	Relative Humidity:	43%
Test Voltage:	AC 120V/60 Hz		
Ant. Pol.	Vertical		
Test Mode:	TX B Mode 2412MHz		
Remark:	No report for the emission which more than 10dB below the prescribed limit.		

No.	Mk.	Freq.	Reading Level	Correct Factor	Measurement	Limit	Over	Detector
		MHz	dBuV	dB/m	dBuV/m	dBuV/m	dB	
1		4824.000	49.93	12.54	62.47	74.00	-11.53	peak
2	*	4824.000	37.70	12.54	50.24	54.00	-3.76	AVG

Remark:

1. Corr. = Antenna Factor (dB/m) + Cable Loss (dB)
2. Peak/AVG (dBuV/m)= Corr. (dB/m)+ Read Level (dBuV)
3. Margin (dB) = Peak/AVG (dBuV/m)-Limit PK/AVG(dBuV/m)

Temperature:	23.7°C	Relative Humidity:	43%
Test Voltage:	AC 120V/60 Hz		
Ant. Pol.	Horizontal		
Test Mode:	TX B Mode 2437MHz		
Remark:	No report for the emission which more than 10dB below the prescribed limit.		

No.	Mk.	Freq.	Reading Level	Correct Factor	Measurement	Limit	Over	
		MHz	dBuV	dB/m	dBuV/m	dBuV/m	dB	Detector
1		4874.000	42.24	13.53	55.77	74.00	-18.23	peak
2	*	4874.000	27.91	13.53	41.44	54.00	-12.56	AVG

Remark:
 1. Corr. = Antenna Factor (dB/m) + Cable Loss (dB)
 2. Peak/AVG (dBµV/m)= Corr. (dB/m)+ Read Level (dBµV)
 3. Margin (dB) = Peak/AVG (dBµV/m)-Limit PK/AVG(dBµV/m)

Temperature:	23.7°C	Relative Humidity:	43%
Test Voltage:	AC 120V/60 Hz		
Ant. Pol.	Vertical		
Test Mode:	TX B Mode 2437MHz		
Remark:	No report for the emission which more than 10dB below the prescribed limit.		

No.	Mk.	Freq.	Reading Level	Correct Factor	Measurement	Limit	Over	
		MHz	dBuV	dB/m	dBuV/m	dBuV/m	dB	Detector
1		4874.000	39.69	13.53	53.22	74.00	-20.78	peak
2	*	4874.000	28.28	13.53	41.81	54.00	-12.19	AVG

Remark:
 1. Corr. = Antenna Factor (dB/m) + Cable Loss (dB)
 2. Peak/AVG (dBµV/m)= Corr. (dB/m)+ Read Level (dBµV)
 3. Margin (dB) = Peak/AVG (dBµV/m)-Limit PK/AVG(dBµV/m)

Temperature:	23.7°C	Relative Humidity:	43%
Test Voltage:	AC 120V/60 Hz		
Ant. Pol.	Horizontal		
Test Mode:	TX B Mode 2462MHz		
Remark:	No report for the emission which more than 10dB below the prescribed limit.		

No.	Mk.	Freq.	Reading Level	Correct Factor	Measurement	Limit	Over	Detector
		MHz	dBuV	dB/m	dBuV/m	dBuV/m	dB	
1		4924.000	42.79	13.89	56.68	74.00	-17.32	peak
2	*	4924.000	31.24	13.89	45.13	54.00	-8.87	AVG

Remark:
 1. Corr. = Antenna Factor (dB/m) + Cable Loss (dB)
 2. Peak/AVG (dBuV/m)= Corr. (dB/m)+ Read Level (dBuV)
 3. Margin (dB) = Peak/AVG (dBuV/m)-Limit PK/AVG(dBuV/m)

Temperature:	23.7°C	Relative Humidity:	43%
Test Voltage:	AC 120V/60 Hz		
Ant. Pol.	Vertical		
Test Mode:	TX B Mode 2462MHz		
Remark:	No report for the emission which more than 10dB below the prescribed limit.		

No.	Mk.	Freq.	Reading Level	Correct Factor	Measurement	Limit	Over	Detector
		MHz	dBuV	dB/m	dBuV/m	dBuV/m	dB	
1		4924.000	41.83	13.89	55.72	74.00	-18.28	peak
2	*	4924.000	29.93	13.89	43.82	54.00	-10.18	AVG

Remark:
 1. Corr. = Antenna Factor (dB/m) + Cable Loss (dB)
 2. Peak/AVG (dBuV/m)= Corr. (dB/m)+ Read Level (dBuV)
 3. Margin (dB) = Peak/AVG (dBuV/m)-Limit PK/AVG(dBuV/m)

Temperature:	23.7°C	Relative Humidity:	43%
Test Voltage:	AC 120V/60 Hz		
Ant. Pol.	Horizontal		
Test Mode:	TX G Mode 2412MHz		
Remark:	No report for the emission which more than 10dB below the prescribed limit.		

No.	Mk.	Freq.	Reading Level	Correct Factor	Measurement	Limit	Over	Detector
		MHz	dBuV	dB/m	dBuV/m	dBuV/m	dB	
1		4824.000	42.01	13.16	55.17	74.00	-18.83	peak
2	*	4824.000	35.48	13.16	48.64	54.00	-5.36	AVG

Remark:

1. Corr. = Antenna Factor (dB/m) + Cable Loss (dB)
2. Peak/AVG (dBμV/m)= Corr. (dB/m)+ Read Level (dBμV)
3. Margin (dB) = Peak/AVG (dBμV/m)-Limit PK/AVG(dBμV/m)

Temperature:	23.7°C	Relative Humidity:	43%
Test Voltage:	AC 120V/60 Hz		
Ant. Pol.	Vertical		
Test Mode:	TX G Mode 2412MHz		
Remark:	No report for the emission which more than 10dB below the prescribed limit.		

No.	Mk.	Freq.	Reading Level	Correct Factor	Measurement	Limit	Over	Detector
		MHz	dBuV	dB/m	dBuV/m	dBuV/m	dB	
		4824.000	42.45	13.16	55.61	74.00	-18.39	peak
	*	4824.000	32.68	13.16	45.84	54.00	-8.16	AVG

Remark:

1. Corr. = Antenna Factor (dB/m) + Cable Loss (dB)
2. Peak/AVG (dBμV/m)= Corr. (dB/m)+ Read Level (dBμV)
3. Margin (dB) = Peak/AVG (dBμV/m)-Limit PK/AVG(dBμV/m)

Temperature:	23.7°C	Relative Humidity:	43%
Test Voltage:	AC 120V/60 Hz		
Ant. Pol.	Horizontal		
Test Mode:	TX G Mode 2437MHz		
Remark:	No report for the emission which more than 10dB below the prescribed limit.		

No.	Mk.	Freq.	Reading Level	Correct Factor	Measurement	Limit	Over	Detector
		MHz	dBuV	dB/m	dBuV/m	dBuV/m	dB	
1		4874.000	40.18	13.53	53.71	74.00	-20.29	peak
2	*	4874.000	32.71	13.53	46.24	54.00	-7.76	AVG

Remark:

1. Corr. = Antenna Factor (dB/m) + Cable Loss (dB)
2. Peak/AVG (dBuV/m)= Corr. (dB/m)+ Read Level (dBuV)
3. Margin (dB) = Peak/AVG (dBuV/m)-Limit PK/AVG(dBuV/m)

Temperature:	23.7°C	Relative Humidity:	43%
Test Voltage:	AC 120V/60 Hz		
Ant. Pol.	Vertical		
Test Mode:	TX G Mode 2437MHz		
Remark:	No report for the emission which more than 10dB below the prescribed limit. Only show the worst case ANT. A.		

No.	Mk.	Freq.	Reading Level	Correct Factor	Measurement	Limit	Over	Detector
		MHz	dBuV	dB/m	dBuV/m	dBuV/m	dB	
1		4874.000	42.02	13.53	55.55	74.00	-18.45	peak
2	*	4874.000	34.56	13.53	48.09	54.00	-5.91	AVG

Remark:

1. Corr. = Antenna Factor (dB/m) + Cable Loss (dB)
2. Peak/AVG (dBuV/m)= Corr. (dB/m)+ Read Level (dBuV)
3. Margin (dB) = Peak/AVG (dBuV/m)-Limit PK/AVG(dBuV/m)

Temperature:	23.7°C	Relative Humidity:	43%
Test Voltage:	AC 120V/60 Hz		
Ant. Pol.	Horizontal		
Test Mode:	TX G Mode 2462MHz		
Remark:	No report for the emission which more than 10dB below the prescribed limit.		

No.	Mk.	Freq.	Reading Level	Correct Factor	Measurement	Limit	Over	
		MHz	dBuV	dB/m	dBuV/m	dBuV/m	dB	Detector
1		4924.000	41.29	13.89	55.18	74.00	-18.82	peak
2	*	4924.000	31.40	13.89	45.29	54.00	-8.71	AVG

Remark:

1. Corr. = Antenna Factor (dB/m) + Cable Loss (dB)
2. Peak/AVG (dBμV/m)= Corr. (dB/m)+ Read Level (dBμV)
3. Margin (dB) = Peak/AVG (dBμV/m)-Limit PK/AVG(dBμV/m)

Temperature:	23.7°C	Relative Humidity:	43%
Test Voltage:	AC 120V/60 Hz		
Ant. Pol.	Vertical		
Test Mode:	TX G Mode 2462MHz		
Remark:	No report for the emission which more than 10dB below the prescribed limit.		

No.	Mk.	Freq.	Reading Level	Correct Factor	Measurement	Limit	Over	
		MHz	dBuV	dB/m	dBuV/m	dBuV/m	dB	Detector
1		4924.000	39.30	13.89	53.19	74.00	-20.81	peak
2	*	4924.000	32.90	13.89	46.79	54.00	-7.21	AVG

Remark:

1. Corr. = Antenna Factor (dB/m) + Cable Loss (dB)
2. Peak/AVG (dBμV/m)= Corr. (dB/m)+ Read Level (dBμV)
3. Margin (dB) = Peak/AVG (dBμV/m)-Limit PK/AVG(dBμV/m)

Temperature:	23.7°C	Relative Humidity:	43%
Test Voltage:	AC 120V/60 Hz		
Ant. Pol.	Horizontal		
Test Mode:	TX n(HT20) Mode 2412MHz		
Remark:	No report for the emission which more than 10dB below the prescribed limit.		

No.	Mk.	Freq.	Reading Level	Correct Factor	Measurement	Limit	Over
		MHz	dBuV	dB/m	dBuV/m	dBuV/m	dB Detector
1		4824.000	43.11	13.16	56.27	74.00	-17.73 peak
2	*	4824.000	32.92	13.16	46.08	54.00	-7.92 AVG

Remark:

1. Corr. = Antenna Factor (dB/m) + Cable Loss (dB)
2. Peak/AVG (dBμV/m)= Corr. (dB/m)+ Read Level (dBμV)
3. Margin (dB) = Peak/AVG (dBμV/m)-Limit PK/AVG(dBμV/m)

Temperature:	23.7°C	Relative Humidity:	43%
Test Voltage:	AC 120V/60 Hz		
Ant. Pol.	Vertical		
Test Mode:	TX n(HT20) Mode 2412MHz		
Remark:	No report for the emission which more than 10dB below the prescribed limit.		

No.	Mk.	Freq.	Reading Level	Correct Factor	Measurement	Limit	Over
		MHz	dBuV	dB/m	dBuV/m	dBuV/m	dB Detector
1		4824.000	39.73	13.16	52.89	74.00	-21.11 peak
2	*	4824.000	27.94	13.16	41.10	54.00	-12.90 AVG

Remark:

1. Corr. = Antenna Factor (dB/m) + Cable Loss (dB)
2. Peak/AVG (dBμV/m)= Corr. (dB/m)+ Read Level (dBμV)
3. Margin (dB) = Peak/AVG (dBμV/m)-Limit PK/AVG(dBμV/m)

Temperature:	23.7°C	Relative Humidity:	43%
Test Voltage:	AC 120V/60 Hz		
Ant. Pol.	Horizontal		
Test Mode:	TX n(HT20) Mode 2437MHz		
Remark:	No report for the emission which more than 10dB below the prescribed limit.		

No.	Mk.	Freq.	Reading Level	Correct Factor	Measurement	Limit	Over	Detector
		MHz	dBuV	dB/m	dBuV/m	dBuV/m	dB	
1		4874.000	41.73	13.53	55.26	74.00	-18.74	peak
2	*	4874.000	34.29	13.53	47.82	54.00	-6.18	AVG

Remark:

1. Corr. = Antenna Factor (dB/m) + Cable Loss (dB)
2. Peak/AVG (dBuV/m)= Corr. (dB/m)+ Read Level (dBuV)
3. Margin (dB) = Peak/AVG (dBuV/m)-Limit PK/AVG(dBuV/m)

Temperature:	23.7°C	Relative Humidity:	43%
Test Voltage:	AC 120V/60 Hz		
Ant. Pol.	Vertical		
Test Mode:	TX n(HT20) Mode 2437MHz		
Remark:	No report for the emission which more than 10dB below the prescribed limit.		

No.	Mk.	Freq.	Reading Level	Correct Factor	Measurement	Limit	Over	Detector
		MHz	dBuV	dB/m	dBuV/m	dBuV/m	dB	
1		4874.000	42.84	13.53	56.37	74.00	-17.63	peak
2	*	4874.000	33.19	13.53	46.72	54.00	-7.28	AVG

Remark:

1. Corr. = Antenna Factor (dB/m) + Cable Loss (dB)
2. Peak/AVG (dBuV/m)= Corr. (dB/m)+ Read Level (dBuV)
3. Margin (dB) = Peak/AVG (dBuV/m)-Limit PK/AVG(dBuV/m)

Temperature:	23.7°C	Relative Humidity:	43%
Test Voltage:	AC 120V/60 Hz		
Ant. Pol.	Horizontal		
Test Mode:	TX n(HT20) Mode 2462MHz		
Remark:	No report for the emission which more than 10dB below the prescribed limit.		

No.	Mk.	Freq.	Reading Level	Correct Factor	Measurement	Limit	Over	Detector
		MHz	dBuV	dB/m	dBuV/m	dBuV/m	dB	
1		4924.000	41.01	13.89	54.90	74.00	-19.10	peak
2	*	4924.000	27.04	13.89	40.93	54.00	-13.07	AVG

Remark:

1. Corr. = Antenna Factor (dB/m) + Cable Loss (dB)
2. Peak/AVG (dBuV/m)= Corr. (dB/m)+ Read Level (dBuV)
3. Margin (dB) = Peak/AVG (dBuV/m)-Limit PK/AVG(dBuV/m)

Temperature:	23.7°C	Relative Humidity:	43%
Test Voltage:	AC 120V/60 Hz		
Ant. Pol.	Vertical		
Test Mode:	TX n(HT20) Mode 2462MHz		
Remark:	No report for the emission which more than 10dB below the prescribed limit.		

No.	Mk.	Freq.	Reading Level	Correct Factor	Measurement	Limit	Over	Detector
		MHz	dBuV	dB/m	dBuV/m	dBuV/m	dB	
1		4924.000	40.73	13.89	54.62	74.00	-19.38	peak
2	*	4924.000	32.88	13.89	46.77	54.00	-7.23	AVG

Remark:

1. Corr. = Antenna Factor (dB/m) + Cable Loss (dB)
2. Peak/AVG (dBuV/m)= Corr. (dB/m)+ Read Level (dBuV)
3. Margin (dB) = Peak/AVG (dBuV/m)-Limit PK/AVG(dBuV/m)

Temperature:	23.7°C	Relative Humidity:	43%
Test Voltage:	AC 120V/60 Hz		
Ant. Pol.	Horizontal		
Test Mode:	TX n(HT40) Mode 2422MHz		
Remark:	No report for the emission which more than 10dB below the prescribed limit.		

No.	Mk.	Freq.	Reading Level	Correct Factor	Measurement	Limit	Over	Detector
		MHz	dBuV	dB/m	dBuV/m	dBuV/m	dB	
1		4844.000	40.01	13.31	53.32	74.00	-20.68	peak
2	*	4844.000	33.72	13.31	47.03	54.00	-6.97	AVG

Remark:

1. Corr. = Antenna Factor (dB/m) + Cable Loss (dB)
2. Peak/AVG (dBμV/m)= Corr. (dB/m)+ Read Level (dBμV)
3. Margin (dB) = Peak/AVG (dBμV/m)-Limit PK/AVG(dBμV/m)

Temperature:	23.7°C	Relative Humidity:	43%
Test Voltage:	AC 120V/60 Hz		
Ant. Pol.	Vertical		
Test Mode:	TX n(HT40) Mode 2422MHz		
Remark:	No report for the emission which more than 10dB below the prescribed limit.		

No.	Mk.	Freq.	Reading Level	Correct Factor	Measurement	Limit	Over	Detector
		MHz	dBuV	dB/m	dBuV/m	dBuV/m	dB	
1		4844.000	41.26	13.31	54.57	74.00	-19.43	peak
2	*	4844.000	31.79	13.31	45.10	54.00	-8.90	AVG

Remark:

1. Corr. = Antenna Factor (dB/m) + Cable Loss (dB)
2. Peak/AVG (dBμV/m)= Corr. (dB/m)+ Read Level (dBμV)
3. Margin (dB) = Peak/AVG (dBμV/m)-Limit PK/AVG(dBμV/m)

Temperature:	23.7°C	Relative Humidity:	43%
Test Voltage:	AC 120V/60 Hz		
Ant. Pol.	Horizontal		
Test Mode:	TX n(HT40) Mode 2437MHz		
Remark:	No report for the emission which more than 10dB below the prescribed limit.		

No.	Mk.	Freq.	Reading Level	Correct Factor	Measurement	Limit	Over	Detector
		MHz	dBuV	dB/m	dBuV/m	dBuV/m	dB	
1		4874.000	43.03	13.53	56.56	74.00	-17.44	peak
2	*	4874.000	32.80	13.53	46.33	54.00	-7.67	AVG

Remark:

1. Corr. = Antenna Factor (dB/m) + Cable Loss (dB)
2. Peak/AVG (dBμV/m)= Corr. (dB/m)+ Read Level (dBμV)
3. Margin (dB) = Peak/AVG (dBμV/m)-Limit PK/AVG(dBμV/m)

Temperature:	23.7°C	Relative Humidity:	43%
Test Voltage:	AC 120V/60 Hz		
Ant. Pol.	Vertical		
Test Mode:	TX n(HT40) Mode 2437MHz		
Remark:	No report for the emission which more than 10dB below the prescribed limit.		

No.	Mk.	Freq.	Reading Level	Correct Factor	Measurement	Limit	Over	Detector
		MHz	dBuV	dB/m	dBuV/m	dBuV/m	dB	
1		4874.000	45.14	13.53	58.67	74.00	-15.33	peak
2	*	4874.000	31.80	13.53	45.33	54.00	-8.67	AVG

Remark:

1. Corr. = Antenna Factor (dB/m) + Cable Loss (dB)
2. Peak/AVG (dBμV/m)= Corr. (dB/m)+ Read Level (dBμV)
3. Margin (dB) = Peak/AVG (dBμV/m)-Limit PK/AVG(dBμV/m)

Temperature:	23.7°C	Relative Humidity:	43%
Test Voltage:	AC 120V/60 Hz		
Ant. Pol.	Horizontal		
Test Mode:	TX n(HT40) Mode 2452MHz		
Remark:	No report for the emission which more than 10dB below the prescribed limit.		

No.	Mk.	Freq.	Reading Level	Correct Factor	Measurement	Limit	Over	
		MHz	dBuV	dB/m	dBuV/m	dBuV/m	dB	Detector
1		4904.000	43.91	13.74	57.65	74.00	-16.35	peak
2	*	4904.000	31.71	13.74	45.45	54.00	-8.55	AVG

Remark:

1. Corr. = Antenna Factor (dB/m) + Cable Loss (dB)
2. Peak/AVG (dBμV/m)= Corr. (dB/m)+ Read Level (dBμV)
3. Margin (dB) = Peak/AVG (dBμV/m)-Limit PK/AVG(dBμV/m)

Temperature:	23.7°C	Relative Humidity:	43%
Test Voltage:	AC 120V/60 Hz		
Ant. Pol.	Vertical		
Test Mode:	TX n(HT40) Mode 2452MHz		
Remark:	No report for the emission which more than 10dB below the prescribed limit.		

No.	Mk.	Freq.	Reading Level	Correct Factor	Measurement	Limit	Over	
		MHz	dBuV	dB/m	dBuV/m	dBuV/m	dB	Detector
1		4904.000	42.16	13.74	55.90	74.00	-18.10	peak
2	*	4904.000	31.91	13.74	45.65	54.00	-8.35	AVG

Remark:

1. Corr. = Antenna Factor (dB/m) + Cable Loss (dB)
2. Peak/AVG (dBμV/m)= Corr. (dB/m)+ Read Level (dBμV)
3. Margin (dB) = Peak/AVG (dBμV/m)-Limit PK/AVG(dBμV/m)

Attachment C-- Restricted Bands Requirement and Band-edge Test Data

(1) Radiation Test

Temperature:	23.5°C	Relative Humidity:	43%
Test Voltage:	AC 120V/60HZ		
Ant. Pol.	Horizontal		
Test Mode:	TX B Mode 2412MHz		
Remark:	Only show the worst case.		

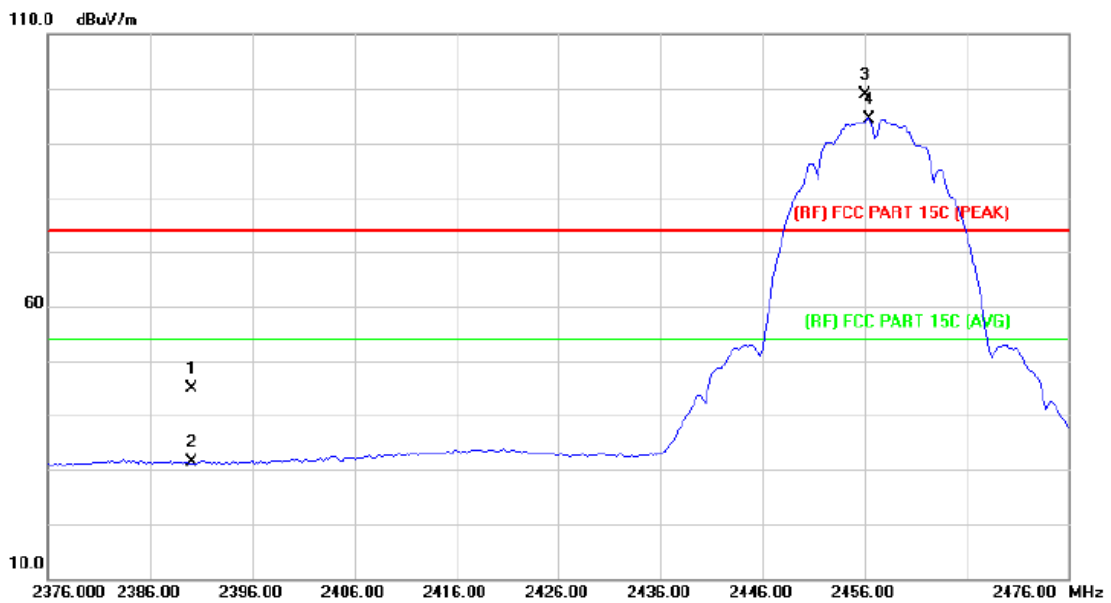

No.	Mk.	Freq.	Reading Level	Correct Factor	Measurement	Limit	Over	Detector
		MHz	dBuV	dB/m	dBuV/m	dBuV/m	dB	
1		2390.000	43.40	1.51	44.91	74.00	-29.09	peak
2		2390.000	29.75	1.51	31.26	54.00	-22.74	AVG
3	X	2456.000	96.90	1.91	98.81	Fundamental Frequency		peak
4	*	2456.400	92.53	1.91	94.44	Fundamental Frequency		AVG

Remark:

1. Corr. = Antenna Factor (dB/m) + Cable Loss (dB)
2. Peak/AVG (dBuV/m) = Corr. (dB/m) + Read Level (dBuV)
3. Margin (dB) = Peak/AVG (dBuV/m) - Limit PK/AVG (dBuV/m)

Temperature:	23.5°C	Relative Humidity:	43%
Test Voltage:	AC 120V/60HZ		
Ant. Pol.	Vertical		
Test Mode:	TX B Mode 2412MHZ		
Remark:	Only show the worst case.		

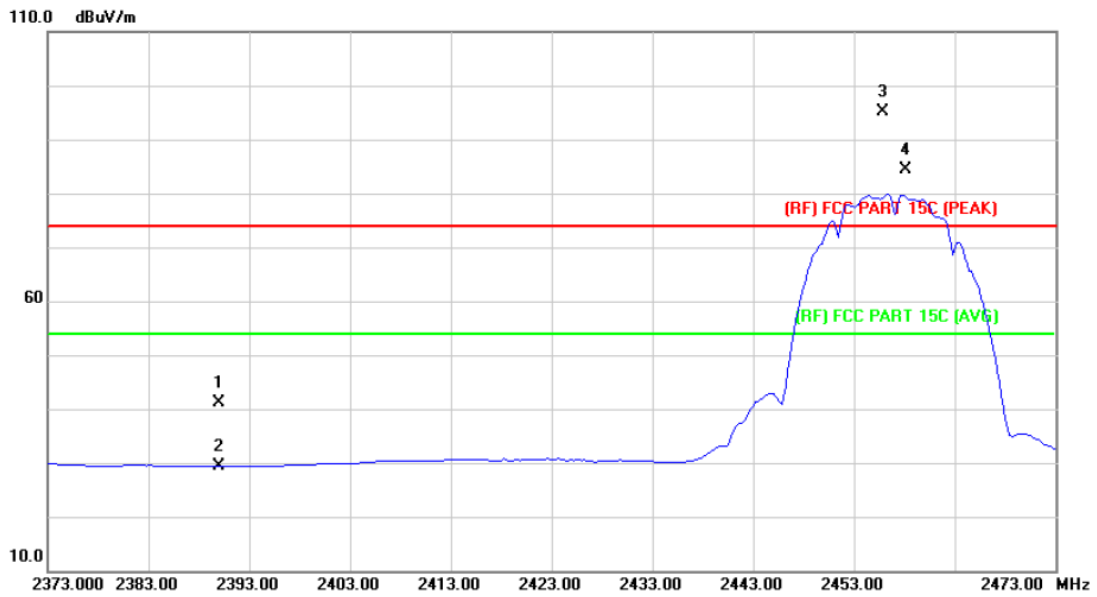

No.	Mk.	Freq. MHz	Reading Level dBuV	Correct Factor dB/m	Measure- ment dBuV/m	Limit dBuV/m	Over dB	Detector
1		2390.000	39.69	1.51	41.20	74.00	-32.80	peak
2		2390.000	27.90	1.51	29.41	54.00	-24.59	AVG
3	X	2455.800	93.21	1.91	95.12	Fundamental Frequency		peak
4	*	2458.200	82.36	1.92	84.28	Fundamental Frequency		AVG

Remark:

1. Corr. = Antenna Factor (dB/m) + Cable Loss (dB)
2. Peak/AVG (dBuV/m) = Corr. (dB/m) + Read Level (dBuV)
3. Margin (dB) = Peak/AVG (dBuV/m) - Limit PK/AVG (dBuV/m)

Temperature:	23.5°C	Relative Humidity:	43%
Test Voltage:	AC 120V/60HZ		
Ant. Pol.	Horizontal		
Test Mode:	TX B Mode 2462MHz		
Remark:	Only show the worst case.		

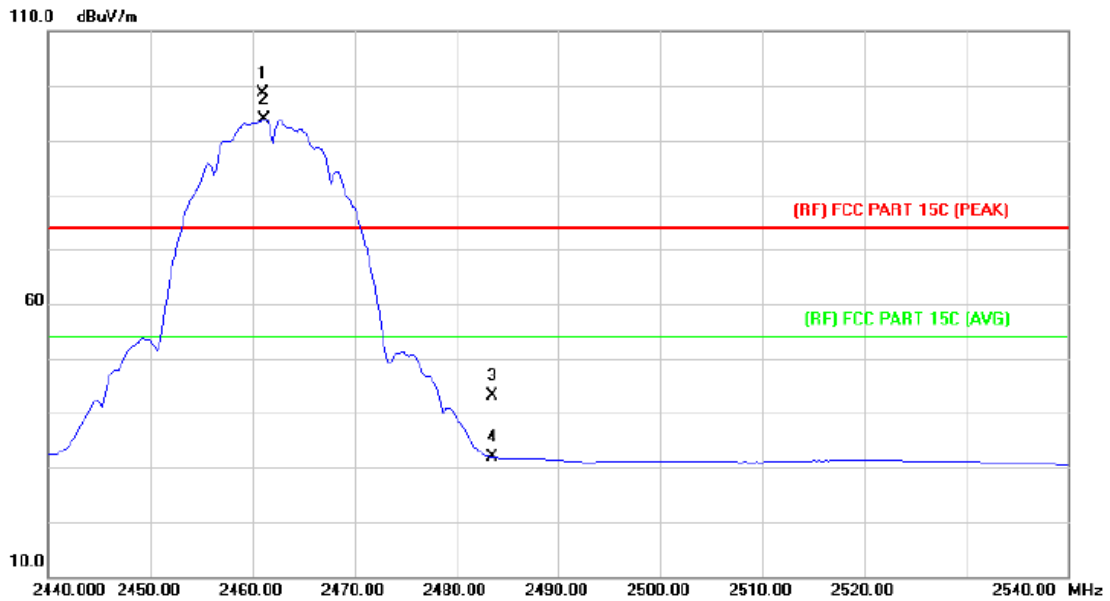

No.	Mk.	Freq. MHz	Reading Level dBuV	Correct Factor dB/m	Measure- ment dBuV/m	Limit dBuV/m	Over dB	Detector
1	X	2461.000	96.59	1.94	98.53	Fundamental Frequency		peak
2	*	2461.200	91.96	1.95	93.91	Fundamental Frequency		AVG
3		2483.500	41.04	2.10	43.14	74.00	-30.86	peak
4		2483.500	29.71	2.10	31.81	54.00	-22.19	AVG

Remark:

1. Corr. = Antenna Factor (dB/m) + Cable Loss (dB)
2. Peak/AVG (dBuV/m) = Corr. (dB/m) + Read Level (dBuV)
3. Margin (dB) = Peak/AVG (dBuV/m) - Limit PK/AVG (dBuV/m)

Temperature:	23.5°C	Relative Humidity:	43%
Test Voltage:	AC 120V/60HZ		
Ant. Pol.	Vertical		
Test Mode:	TX B Mode 2462MHz		
Remark:	Only show the worst case.		

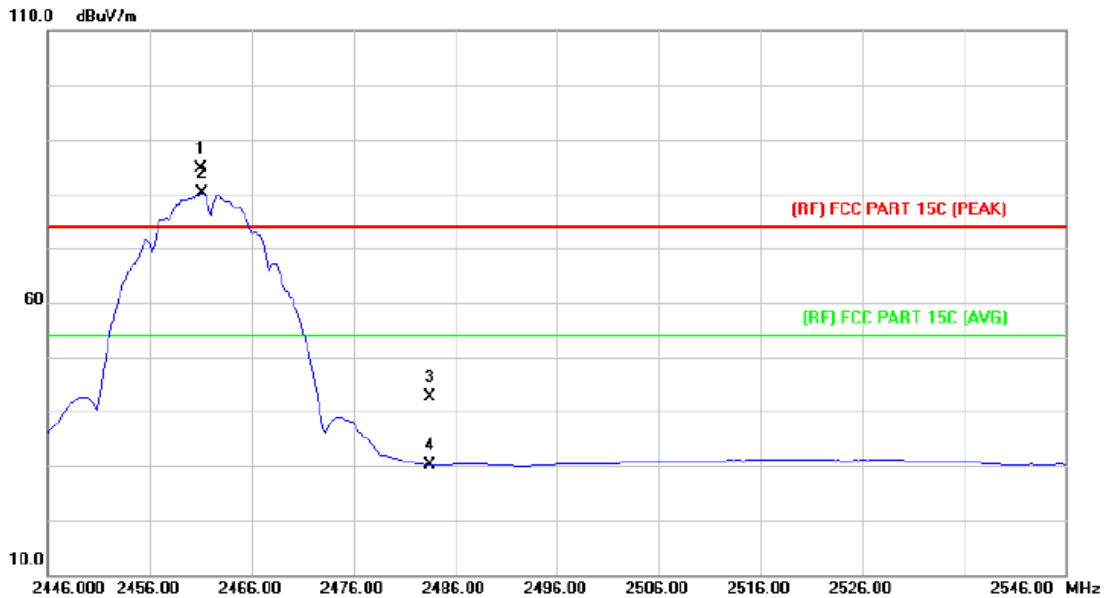

No.	Mk.	Freq. MHz	Reading Level dBuV	Correct Factor dB/m	Measure- ment dBuV/m	Limit dBuV/m	Over dB	Detector
1	X	2461.000	82.77	1.94	84.71	Fundamental Frequency		peak
2	*	2461.200	78.19	1.95	80.14	Fundamental Frequency		AVG
3		2483.500	40.50	2.10	42.60	74.00	-31.40	peak
4		2483.500	28.10	2.10	30.20	54.00	-23.80	AVG

Remark:

1. Corr. = Antenna Factor (dB/m) + Cable Loss (dB)
2. Peak/AVG (dBuV/m) = Corr. (dB/m) + Read Level (dBuV)
3. Margin (dB) = Peak/AVG (dBuV/m) - Limit PK/AVG (dBuV/m)

Temperature:	23.5°C	Relative Humidity:	43%
Test Voltage:	AC 120V/60HZ		
Ant. Pol.	Horizontal		
Test Mode:	TX G Mode 2412MHz		
Remark:	Only show the worst case.		

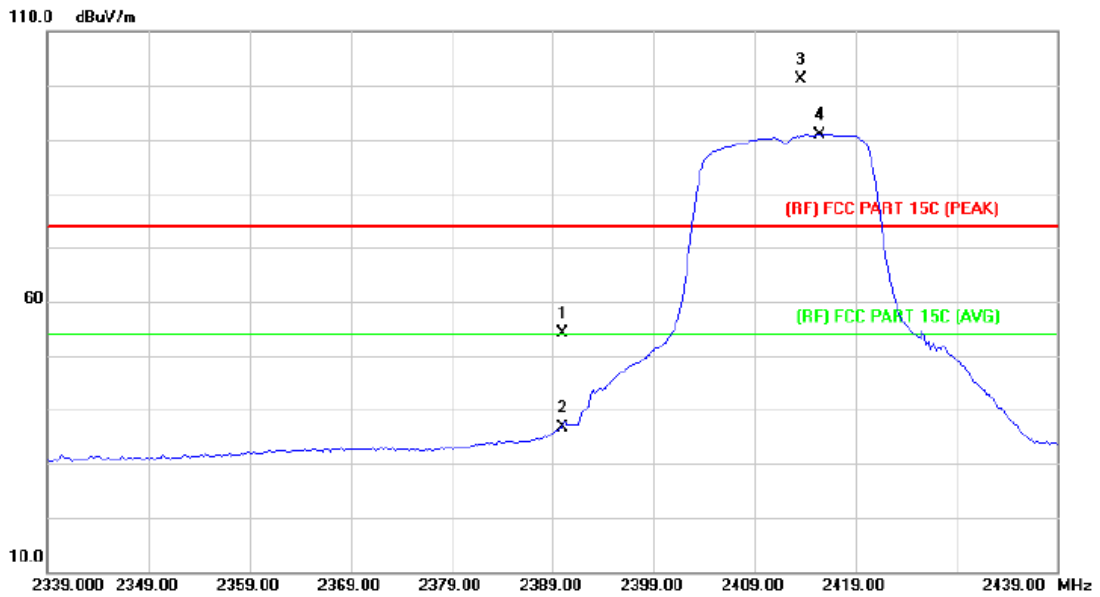

No.	Mk.	Freq. MHz	Reading Level dBuV	Correct Factor dB/m	Measure- ment dBuV/m	Limit dBuV/m	Over dB	Detector
1		2390.000	52.52	1.51	54.03	74.00	-19.97	peak
2		2390.000	35.09	1.51	36.60	54.00	-17.40	AVG
3	X	2413.600	99.57	1.63	101.20	Fundamental Frequency		peak
4	*	2415.400	89.16	1.64	90.80	Fundamental Frequency		AVG

Remark:

1. Corr. = Antenna Factor (dB/m) + Cable Loss (dB)
2. Peak/AVG (dBμV/m) = Corr. (dB/m) + Read Level (dBμV)
3. Margin (dB) = Peak/AVG (dBμV/m) - Limit PK/AVG (dBμV/m)

Temperature:	23.5°C	Relative Humidity:	43%
Test Voltage:	AC 120V/60HZ		
Ant. Pol.	Vertical		
Test Mode:	TX G Mode 2412MHz		
Remark:	Only show the worst case.		

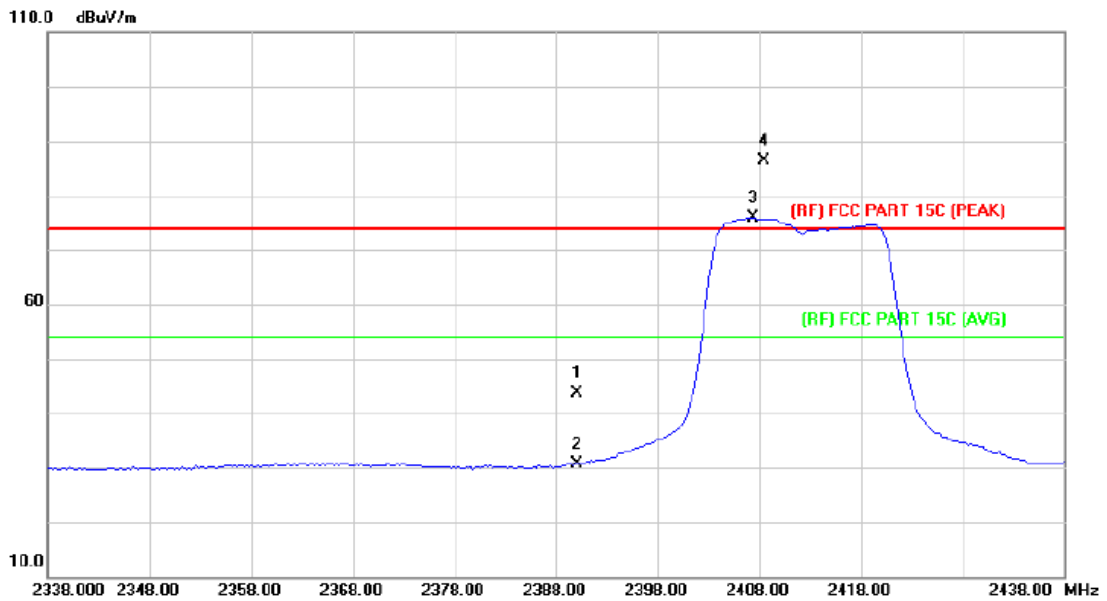

No.	Mk.	Freq. MHz	Reading Level dBuV	Correct Factor dB/m	Measurement dBuV/m	Limit dBuV/m	Over dB	Detector
1		2390.000	42.01	1.51	43.52	74.00	-30.48	peak
2		2390.000	29.18	1.51	30.69	54.00	-23.31	AVG
3	*	2407.400	74.21	1.59	75.80	Fundamental Frequency		AVG
4	X	2408.400	84.71	1.60	86.31	Fundamental Frequency		peak

Remark:

1. Corr. = Antenna Factor (dB/m) + Cable Loss (dB)
2. Peak/AVG (dBuV/m) = Corr. (dB/m) + Read Level (dBuV)
3. Margin (dB) = Peak/AVG (dBuV/m) - Limit PK/AVG (dBuV/m)

Temperature:	23.5°C	Relative Humidity:	43%
Test Voltage:	AC 120V/60HZ		
Ant. Pol.	Horizontal		
Test Mode:	TX G Mode 2462MHz		
Remark:	Only show the worst case.		

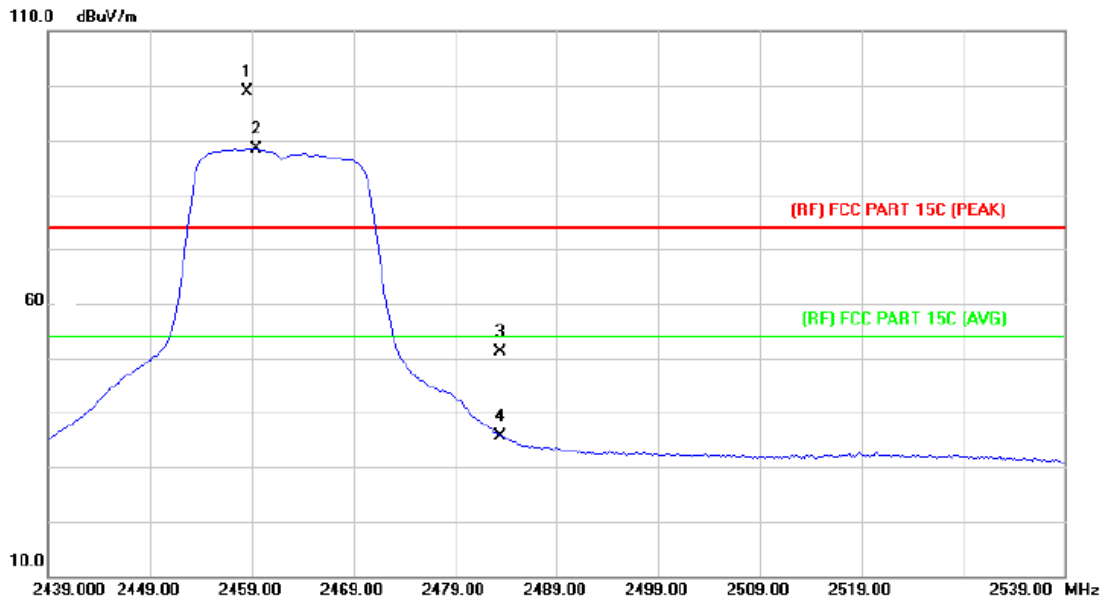

No.	Mk.	Freq. MHz	Reading Level dBuV	Correct Factor dB/m	Measure- ment dBuV/m	Limit dBuV/m	Over dB	Detector
1	X	2458.600	96.88	1.92	98.80	Fundamental Frequency		peak
2	*	2459.400	86.47	1.93	88.40	Fundamental Frequency		AVG
3		2483.500	49.15	2.10	51.25	74.00	-22.75	peak
4		2483.500	33.62	2.10	35.72	54.00	-18.28	AVG

Remark:

1. Corr. = Antenna Factor (dB/m) + Cable Loss (dB)
2. Peak/AVG (dBuV/m) = Corr. (dB/m) + Read Level (dBuV)
3. Margin (dB) = Peak/AVG (dBuV/m) - Limit PK/AVG (dBuV/m)

Temperature:	23.5°C	Relative Humidity:	43%
Test Voltage:	AC 120V/60HZ		
Ant. Pol.	Vertical		
Test Mode:	TX G Mode 2462MHz ANT. A+ANT. B		
Remark:	Only show the worst case.		

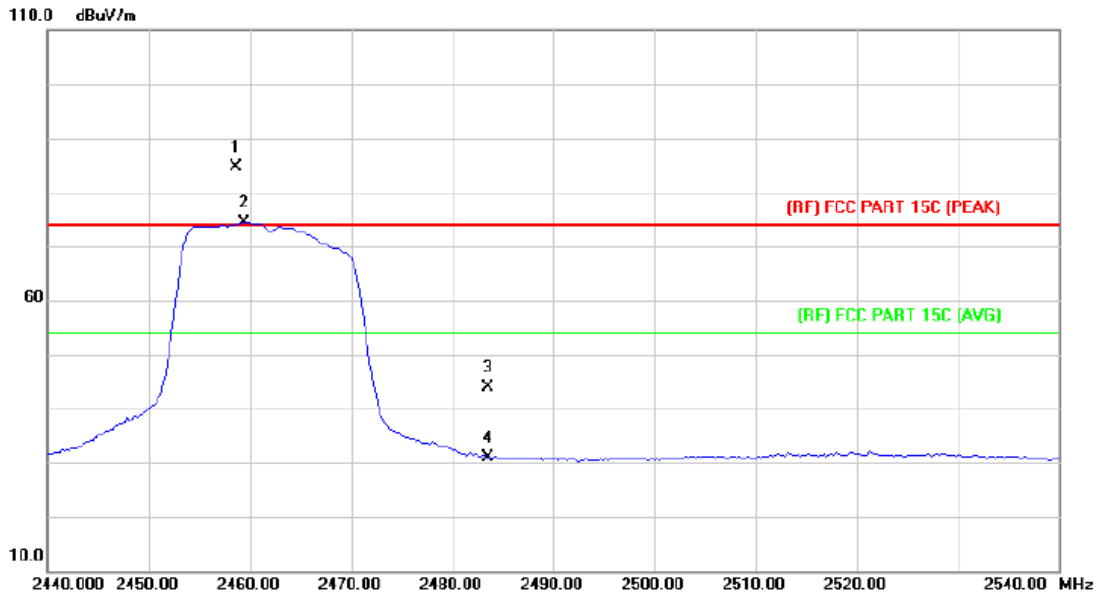

No.	Mk.	Freq. MHz	Reading Level dBuV	Correct Factor dB/m	Measure- ment dBuV/m	Limit dBuV/m	Over dB	Detector
1	*	2457.800	92.35	3.25	95.60	Fundamental Frequency		AVG
2	X	2460.000	101.10	3.27	104.37	Fundamental Frequency		peak
3		2483.500	53.35	3.40	56.75	74.00	-17.25	peak
4		2483.500	37.92	3.40	41.32	54.00	-12.68	AVG

Remark:

1. Corr. = Antenna Factor (dB/m) + Cable Loss (dB)
2. Peak/AVG (dBμV/m) = Corr. (dB/m) + Read Level (dBμV)
3. Margin (dB) = Peak/AVG (dBμV/m) - Limit PK/AVG (dBμV/m)

Temperature:	23.5°C	Relative Humidity:	43%
Test Voltage:	AC 120V/60HZ		
Ant. Pol.	Horizontal		
Test Mode:	TX N(HT20) Mode 2412MHz		
Remark:	Only show the worst case.		

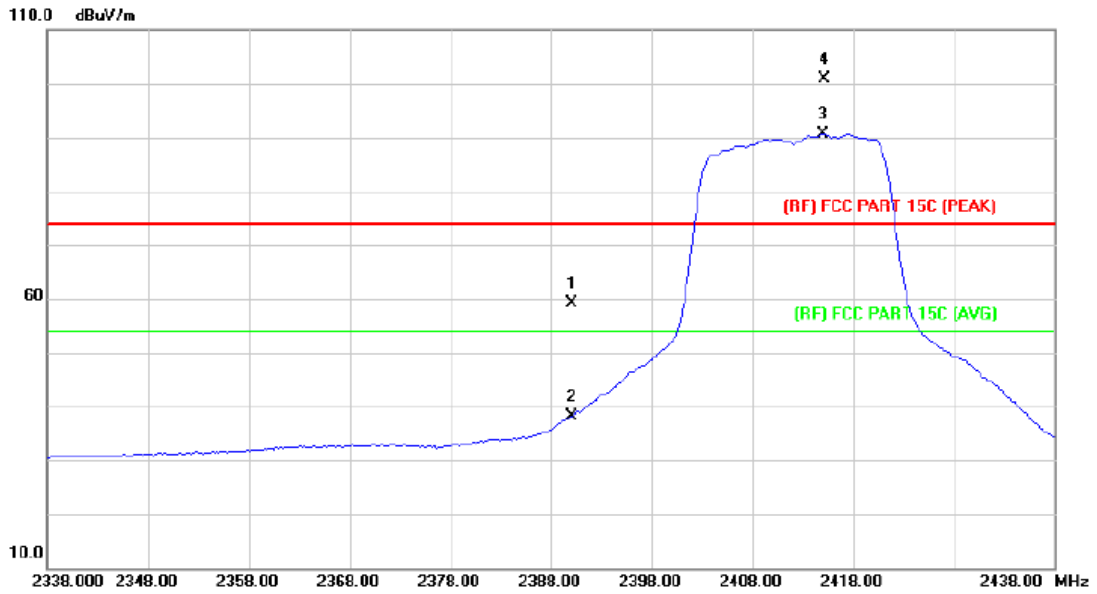

No.	Mk.	Freq. MHz	Reading Level dBuV	Correct Factor dB/m	Measure- ment dBuV/m	Limit dBuV/m	Over dB	Detector
1		2390.000	57.73	1.51	59.24	74.00	-14.76	peak
2		2390.000	36.68	1.51	38.19	54.00	-15.81	AVG
3	*	2415.000	88.95	1.63	90.58	Fundamental Frequency		AVG
4	X	2415.200	99.13	1.64	100.77	Fundamental Frequency		peak

Remark:

1. Corr. = Antenna Factor (dB/m) + Cable Loss (dB)
2. Peak/AVG (dBuV/m) = Corr. (dB/m) + Read Level (dBuV)
3. Margin (dB) = Peak/AVG (dBuV/m) - Limit PK/AVG (dBuV/m)

Temperature:	23.5°C	Relative Humidity:	43%
Test Voltage:	AC 120V/60HZ		
Ant. Pol.	Vertical		
Test Mode:	TX N(HT20) Mode 2412MHz		
Remark:	Only show the worst case.		

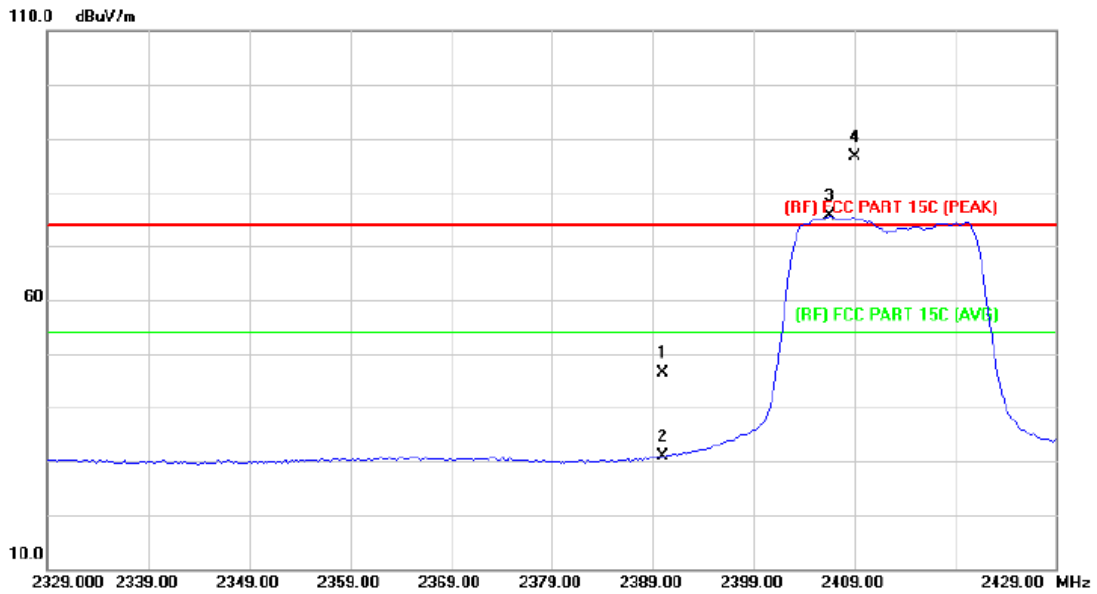

No.	Mk.	Freq. MHz	Reading Level dBuV	Correct Factor dB/m	Measure- ment dBuV/m	Limit dBuV/m	Over dB	Detector
1		2390.000	44.97	1.51	46.48	74.00	-27.52	peak
2		2390.000	29.42	1.51	30.93	54.00	-23.07	AVG
3	*	2406.600	73.97	1.58	75.55	Fundamental Frequency		AVG
4	X	2409.000	84.93	1.60	86.53	Fundamental Frequency		peak

Remark:

1. Corr. = Antenna Factor (dB/m) + Cable Loss (dB)
2. Peak/AVG (dBμV/m)= Corr. (dB/m)+ Read Level (dBμV)
3. Margin (dB) = Peak/AVG (dBμV/m)-Limit PK/AVG(dBμV/m)

Temperature:	23.5°C	Relative Humidity:	43%
Test Voltage:	AC 120V/60HZ		
Ant. Pol.	Horizontal		
Test Mode:	TX N(HT20) Mode 2462MHz		
Remark:	Only show the worst case.		

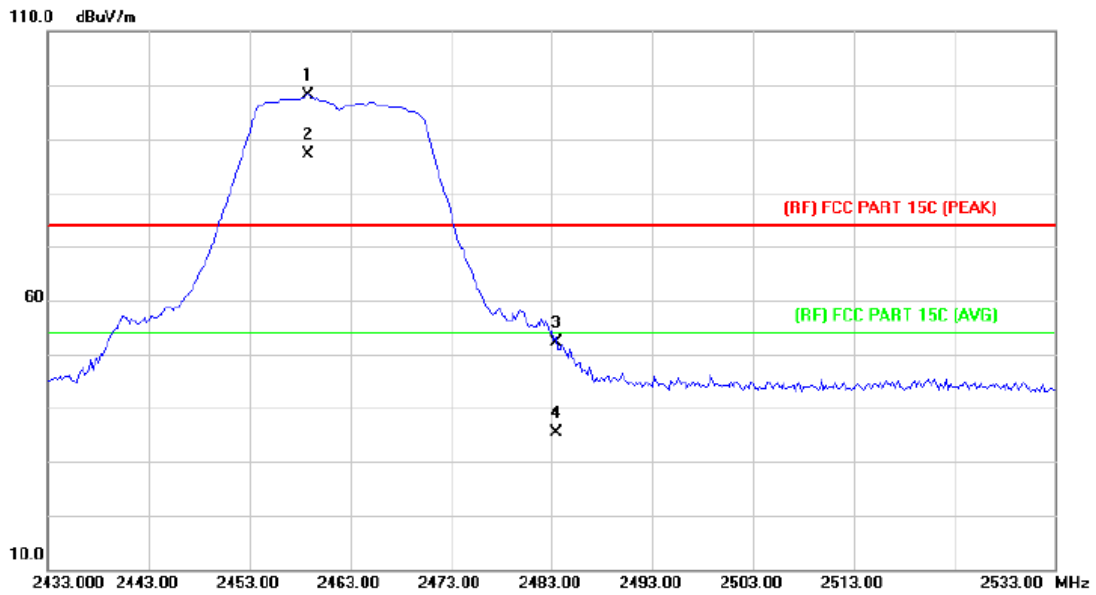

No.	Mk.	Freq. MHz	Reading Level dBuV	Correct Factor dB/m	Measure- ment dBuV/m	Limit dBuV/m	Over dB	Detector
1	X	2458.800	96.32	1.92	98.24	Fundamental Frequency		peak
2	*	2458.800	85.18	1.92	87.10	Fundamental Frequency		AVG
3		2483.500	49.92	2.10	52.02	74.00	-21.98	peak
4		2483.500	33.40	2.10	35.50	54.00	-18.50	AVG

Remark:

1. Corr. = Antenna Factor (dB/m) + Cable Loss (dB)
2. Peak/AVG (dBuV/m) = Corr. (dB/m) + Read Level (dBuV)
3. Margin (dB) = Peak/AVG (dBuV/m) - Limit PK/AVG (dBuV/m)

Temperature:	23.5°C	Relative Humidity:	43%
Test Voltage:	AC 120V/60HZ		
Ant. Pol.	Vertical		
Test Mode:	TX N(HT20) Mode 2462MHz		
Remark:	Only show the worst case.		

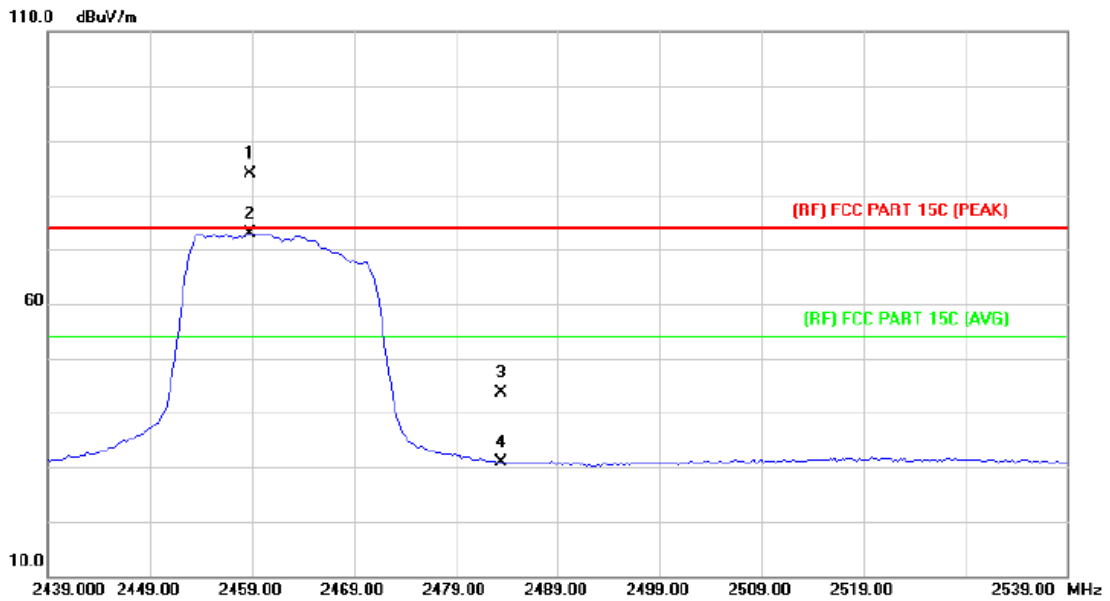

No.	Mk.	Freq. MHz	Reading Level dBuV	Correct Factor dB/m	Measure- ment dBuV/m	Limit dBuV/m	Over dB	Detector
1	X	2458.800	82.01	1.92	83.93	Fundamental Frequency		peak
2	*	2458.800	70.90	1.92	72.82	Fundamental Frequency		AVG
3		2483.500	41.64	2.10	43.74	74.00	-30.26	peak
4		2483.500	28.67	2.10	30.77	54.00	-23.23	AVG

Remark:

1. Corr. = Antenna Factor (dB/m) + Cable Loss (dB)
2. Peak/AVG (dBuV/m) = Corr. (dB/m) + Read Level (dBuV)
3. Margin (dB) = Peak/AVG (dBuV/m) - Limit PK/AVG (dBuV/m)

Temperature:	23.5°C	Relative Humidity:	43%
Test Voltage:	AC 120V/60HZ		
Ant. Pol.	Horizontal		
Test Mode:	TX N(HT40) Mode 2422MHz		
Remark:	Only show the worst case.		

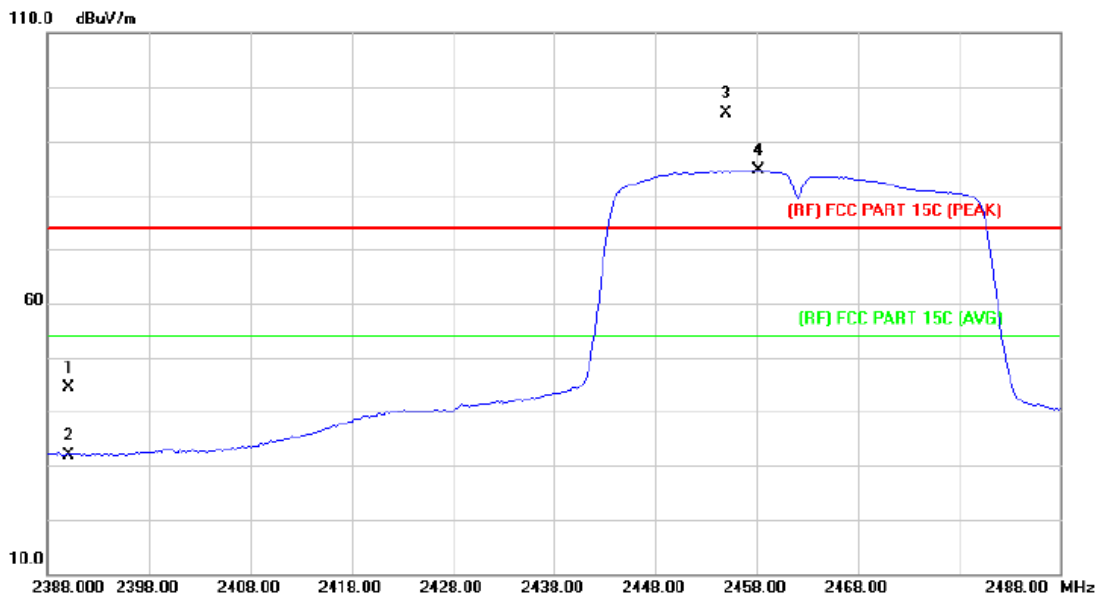

No.	Mk.	Freq. MHz	Reading Level dBuV	Correct Factor dB/m	Measure- ment dBuV/m	Limit dBuV/m	Over dB	Detector
1		2390.000	42.82	1.51	44.33	74.00	-29.67	peak
2		2390.000	30.33	1.51	31.84	54.00	-22.16	AVG
3	X	2455.000	93.20	1.90	95.10	Fundamental Frequency		peak
4	*	2458.200	82.61	1.92	84.53	Fundamental Frequency		AVG

Remark:

1. Corr. = Antenna Factor (dB/m) + Cable Loss (dB)
2. Peak/AVG (dBμV/m) = Corr. (dB/m) + Read Level (dBμV)
3. Margin (dB) = Peak/AVG (dBμV/m) - Limit PK/AVG (dBμV/m)

Temperature:	23.5°C	Relative Humidity:	43%
Test Voltage:	AC 120V/60HZ		
Ant. Pol.	Vertical		
Test Mode:	TX N(HT40) Mode 2422MHz		
Remark:	Only show the worst case.		

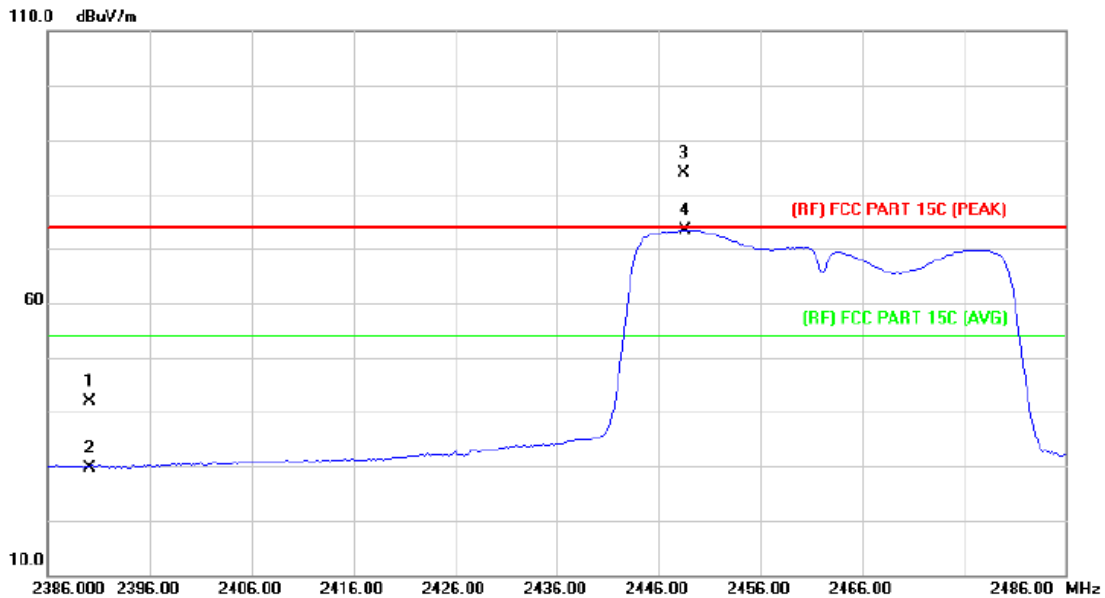

No.	Mk.	Freq. MHz	Reading Level dBuV	Correct Factor dB/m	Measure- ment dBuV/m	Limit dBuV/m	Over dB	Detector
1		2390.000	40.25	1.51	41.76	74.00	-32.24	peak
2		2390.000	28.23	1.51	29.74	54.00	-24.26	AVG
3	X	2448.400	82.11	1.86	83.97	Fundamental Frequency		peak
4	*	2448.600	71.52	1.86	73.38	Fundamental Frequency		AVG

Remark:

1. Corr. = Antenna Factor (dB/m) + Cable Loss (dB)
2. Peak/AVG (dBuV/m) = Corr. (dB/m) + Read Level (dBuV)
3. Margin (dB) = Peak/AVG (dBuV/m) - Limit PK/AVG (dBuV/m)

Temperature:	23.5°C	Relative Humidity:	43%
Test Voltage:	AC 120V/60HZ		
Ant. Pol.	Horizontal		
Test Mode:	TX N(HT40) Mode 2452MHz		
Remark:	Only show the worst case.		

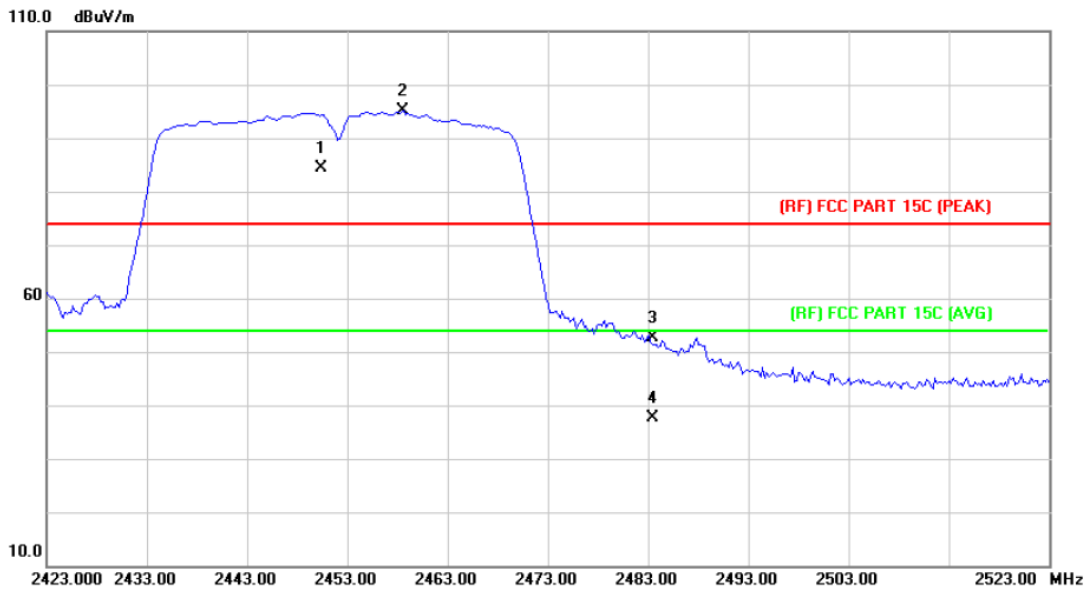

No.	Mk.	Freq. MHz	Reading Level dBuV	Correct Factor dB/m	Measurement dBuV/m	Limit dBuV/m	Over dB	Detector
1	*	2450.400	82.54	1.87	84.41	Fundamental Frequency		AVG
2	X	2458.600	93.12	1.92	95.04	Fundamental Frequency		peak
3		2483.500	50.46	2.10	52.56	74.00	-21.44	peak
4		2483.500	35.53	2.10	37.63	54.00	-16.37	AVG

Remark:

1. Corr. = Antenna Factor (dB/m) + Cable Loss (dB)
2. Peak/AVG (dBμV/m)= Corr. (dB/m)+ Read Level (dBμV)
3. Margin (dB) = Peak/AVG (dBμV/m)-Limit PK/AVG(dBμV/m)

Temperature:	23.5°C	Relative Humidity:	43%
Test Voltage:	AC 120V/60HZ		
Ant. Pol.	Vertical		
Test Mode:	TX N(HT40) Mode 2452MHZ		
Remark:	Only show the worst case.		

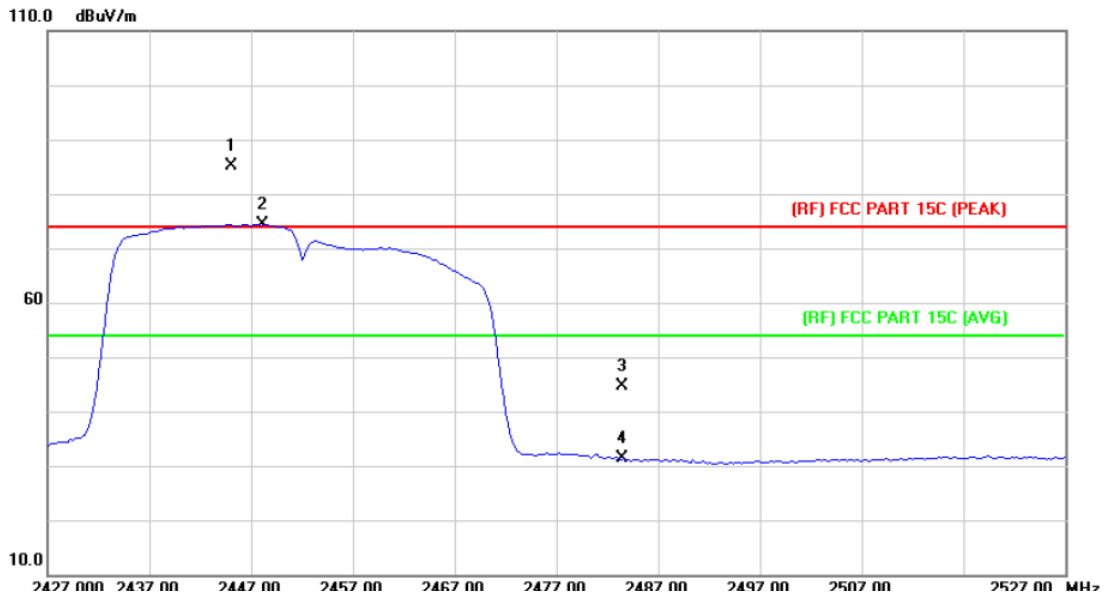

No.	Mk.	Freq.	Reading Level	Correct Factor	Measurement	Limit	Over	
		MHz	dBuV	dB/m	dBuV/m	dBuV/m	dB	Detector
1	X	2445.000	83.29	1.84	85.13	Fundamental Frequency		peak
2	*	2448.200	72.60	1.86	74.46	Fundamental Frequency		AVG
3		2483.500	42.42	2.10	44.52	74.00	-29.48	peak
4		2483.500	29.17	2.10	31.27	54.00	-22.73	AVG

Remark:

1. Corr. = Antenna Factor (dB/m) + Cable Loss (dB)
2. Peak/AVG (dBμV/m)= Corr. (dB/m)+ Read Level (dBμV)
3. Margin (dB) = Peak/AVG (dBμV/m)-Limit PK/AVG(dBμV/m)

(2) Conducted Test

Temperature:	25°C	Relative Humidity:	55%
Test Voltage:	AC 120V/60HZ		
Test Mode:	TX B Mode 2412MHz / TX B Mode 2462MHz		
Remark:	The EUT is programmed in continuously transmitting mode		

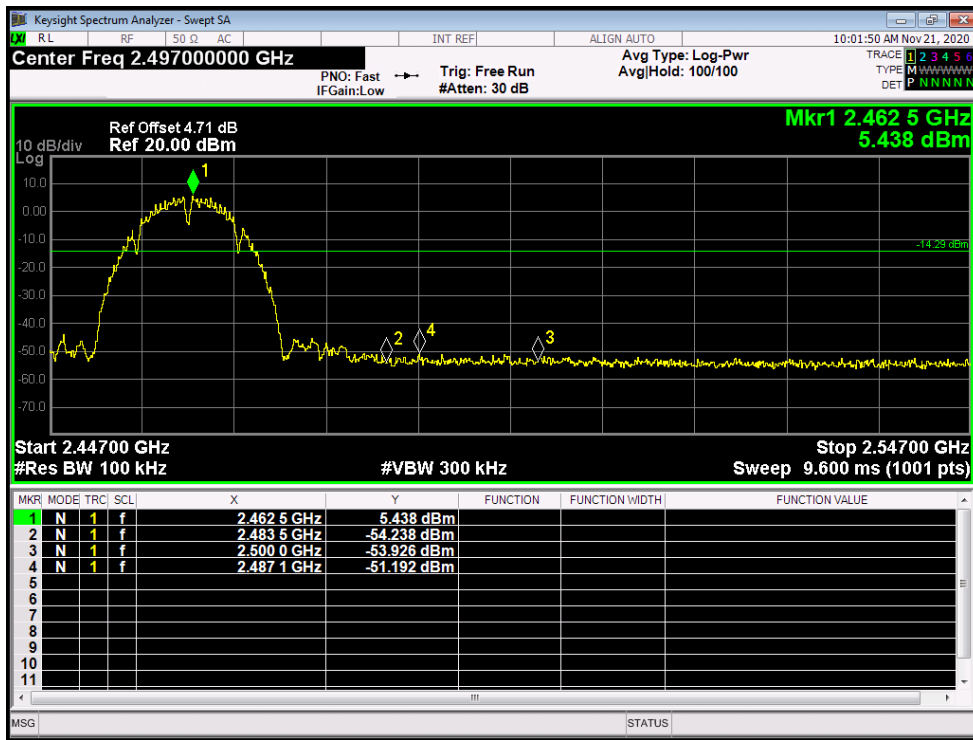
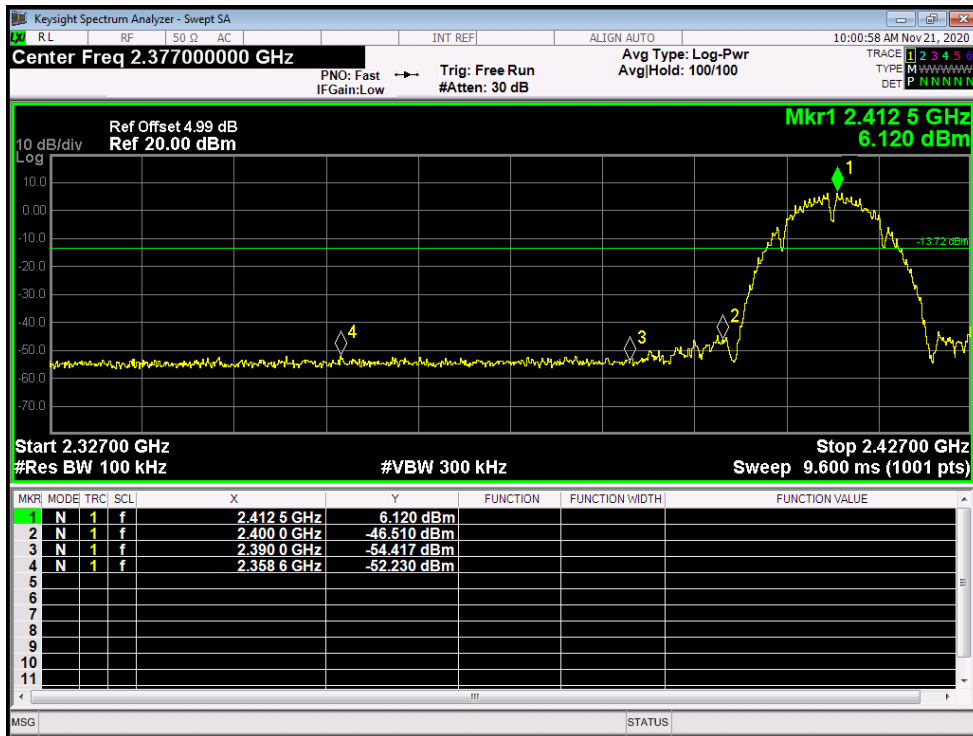

Temperature:	25°C	Relative Humidity:	55%
Test Voltage:	AC 120V/60HZ		
Test Mode:	TX G Mode 2412MHz / TX G Mode 2462MHz		
Remark:	The EUT is programmed in continuously transmitting mode		

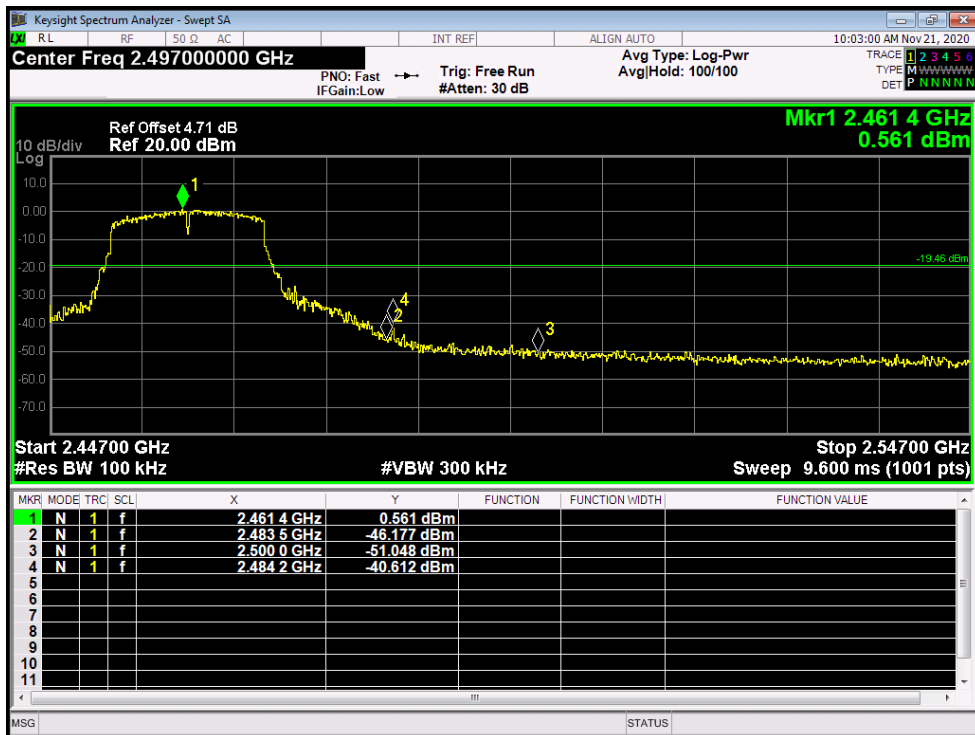
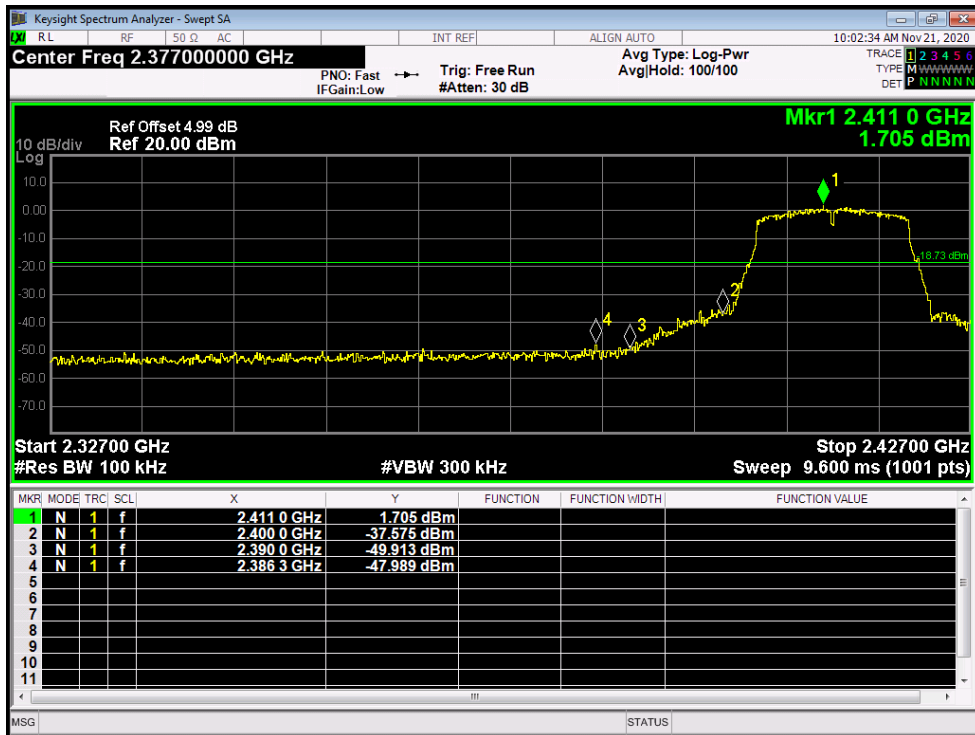

Temperature:	25°C	Relative Humidity:	55%
Test Voltage:	AC 120V/60HZ		
Test Mode:	TX N(HT20) Mode 2412MHz / TX N(HT20) Mode 2462MHz		
Remark:	The EUT is programmed in continuously transmitting mode		

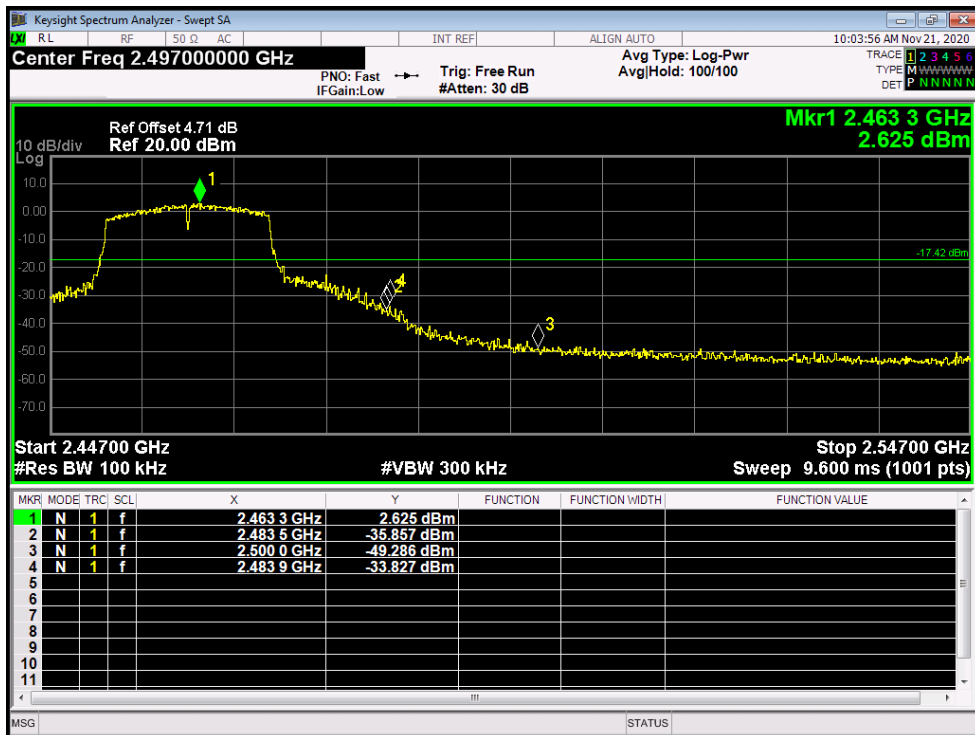
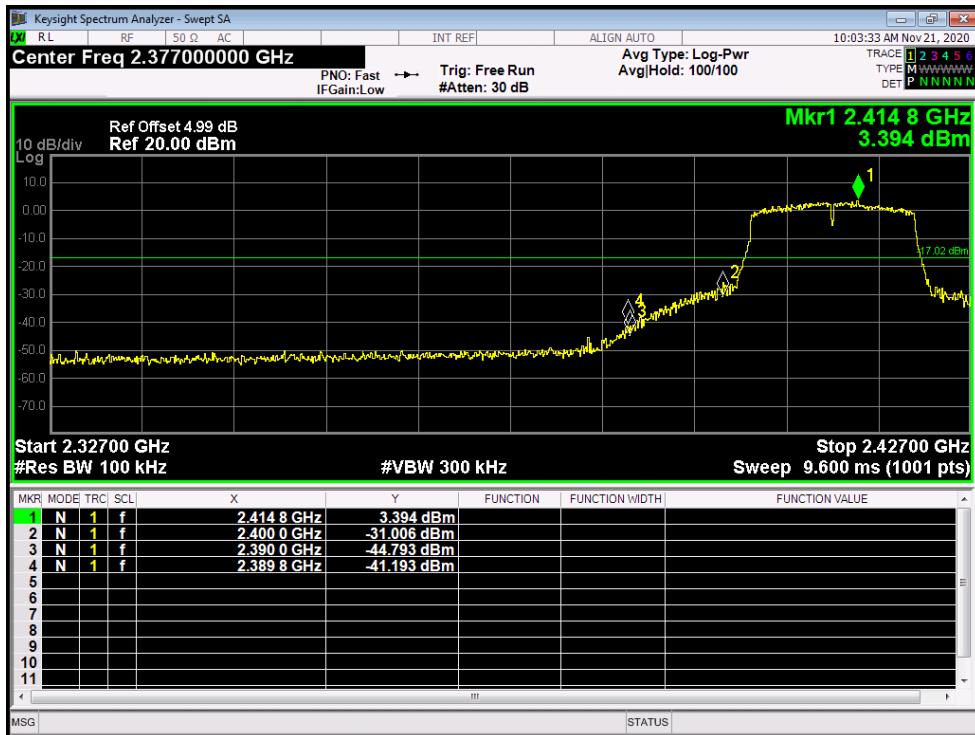

Temperature:	25°C	Relative Humidity:	55%
Test Voltage:	AC 120V/60HZ		
Test Mode:	TX N(HT40) Mode 2422MHz / TX N(HT40) Mode 2452MHz		
Remark:	The EUT is programmed in continuously transmitting mode		

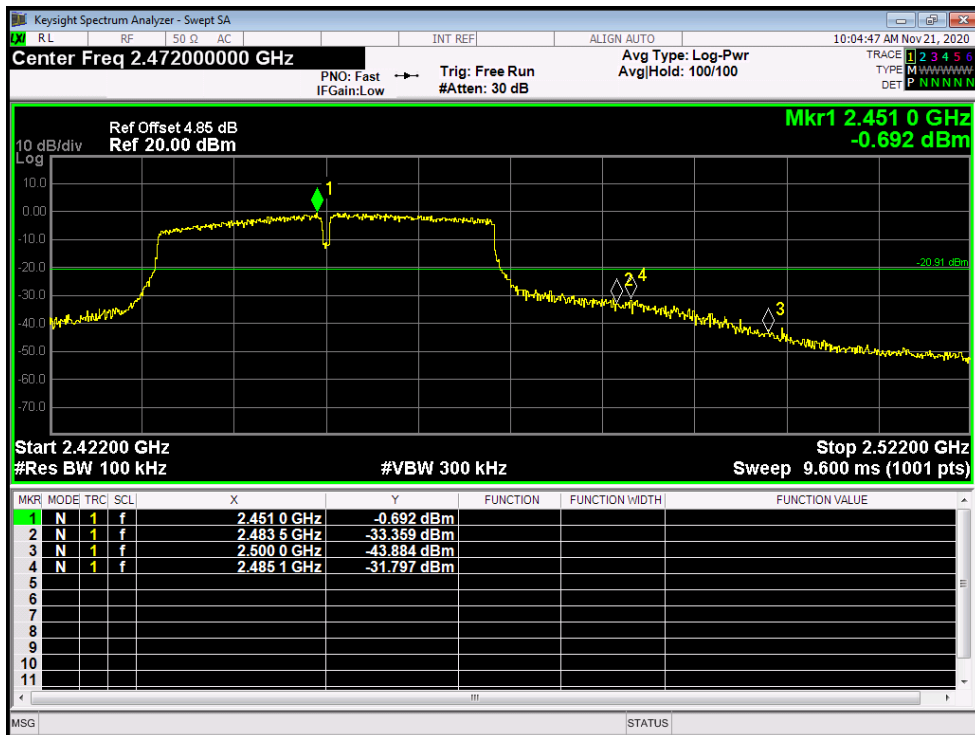
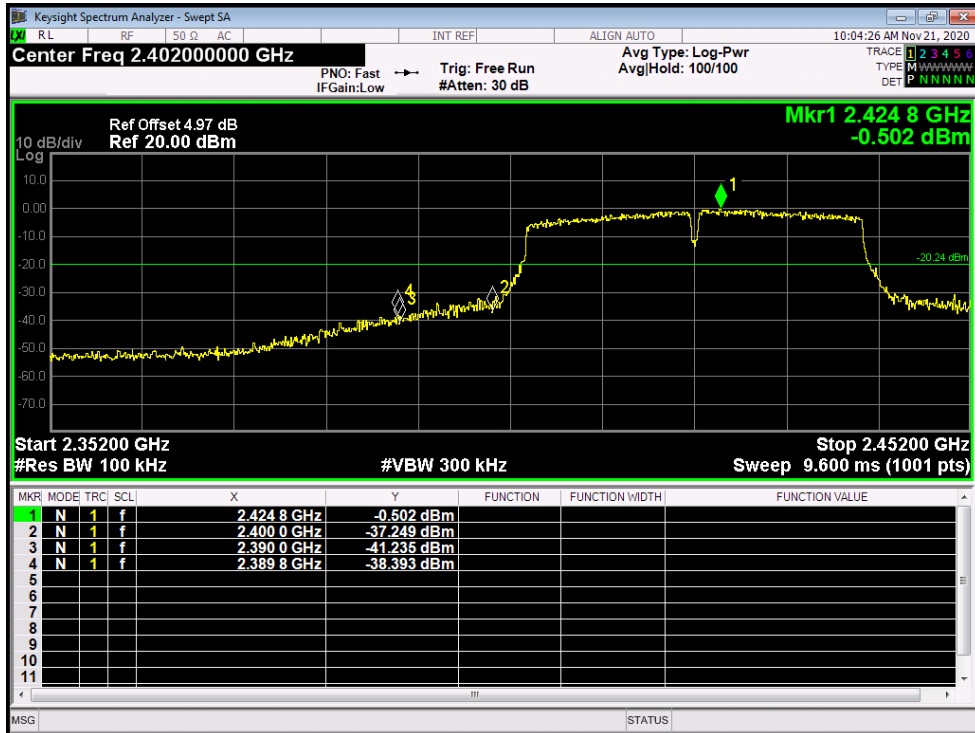

Attachment D-- Bandwidth Test Data

Temperature:	25°C	Relative Humidity:	55%
Test Voltage:	AC 120V/60HZ		
Test Mode:	TX 802.11B Mode		
Channel frequency (MHz)	6dB Bandwidth (MHz)	99% Bandwidth (MHz)	Limit (MHz)
2412	9.558	14.717	>=0.5
2437	10.03	14.780	
2462	10.05	14.715	

802.11B Mode

2412 MHz

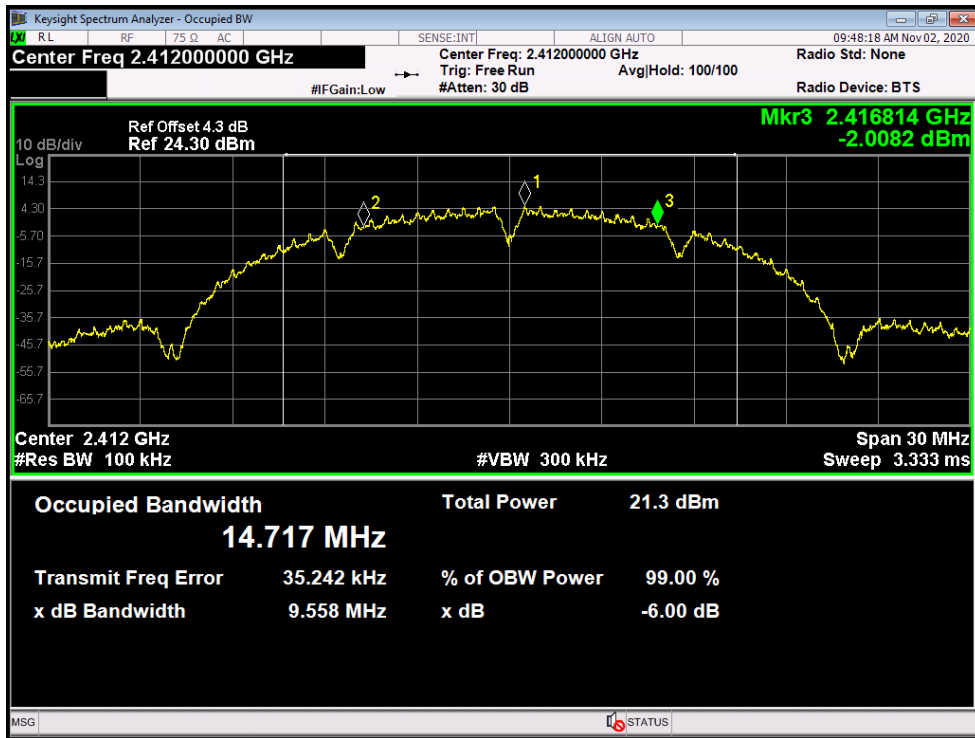

802.11B Mode
2437 MHz

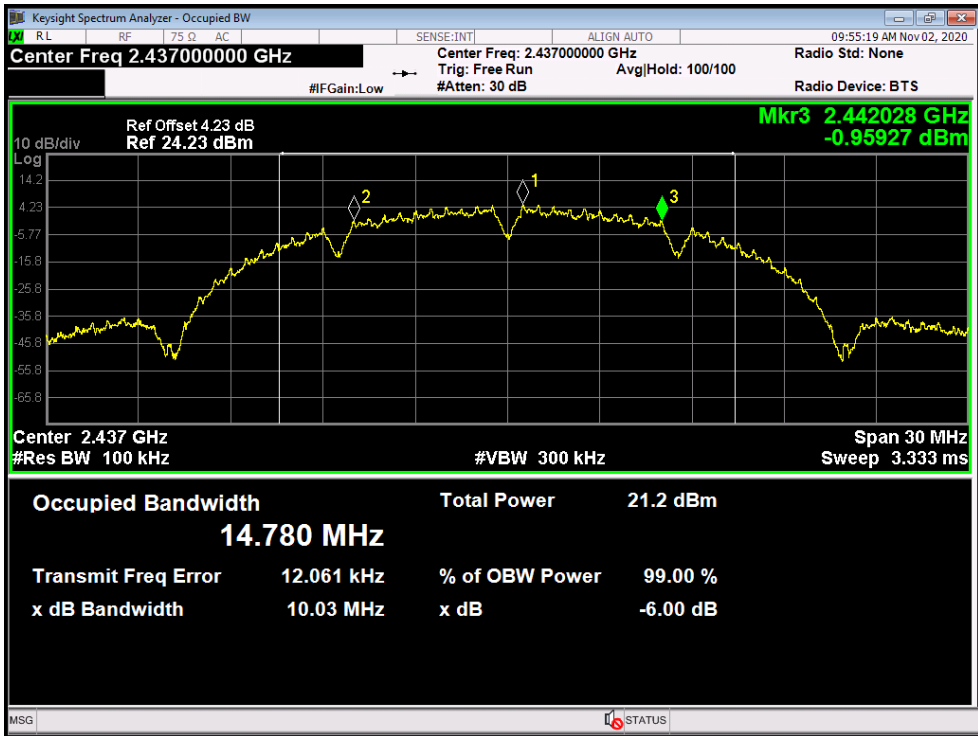

802.11B Mode
2462 MHz

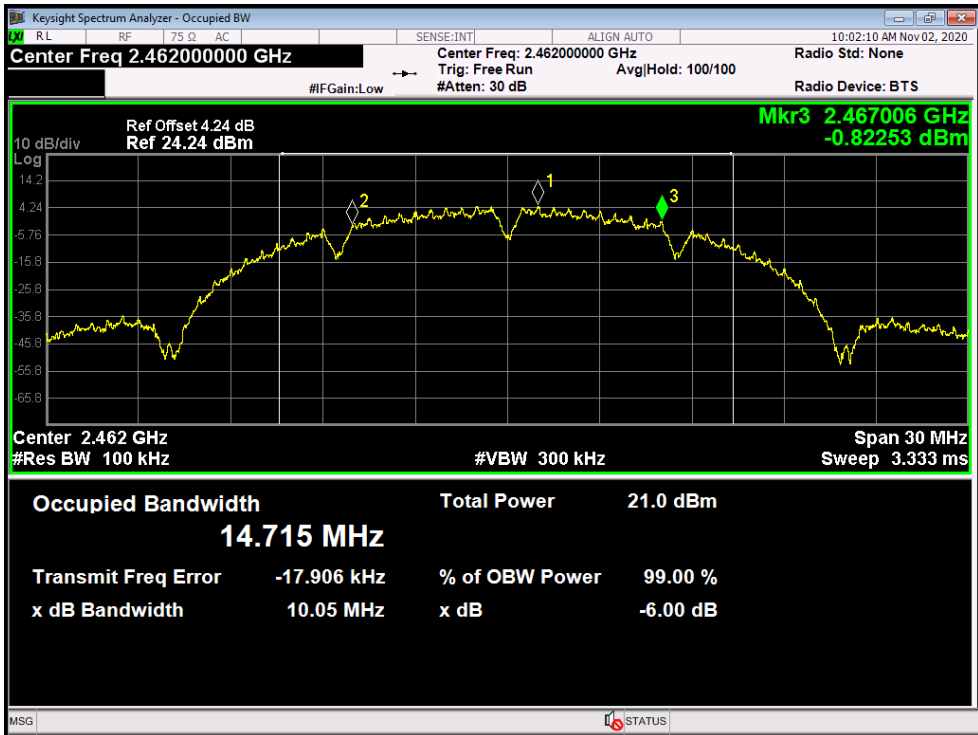

Temperature:	25°C	Relative Humidity:	55%
Test Voltage:	AC 120V/60HZ		
Test Mode:	TX 802.11G Mode		
Channel frequency (MHz)	6dB Bandwidth (MHz)	99% Bandwidth (MHz)	Limit (MHz)
2412	16.46	16.424	>=0.5
2437	16.51	16.440	
2462	16.49	16.434	

802.11G Mode

2412 MHz

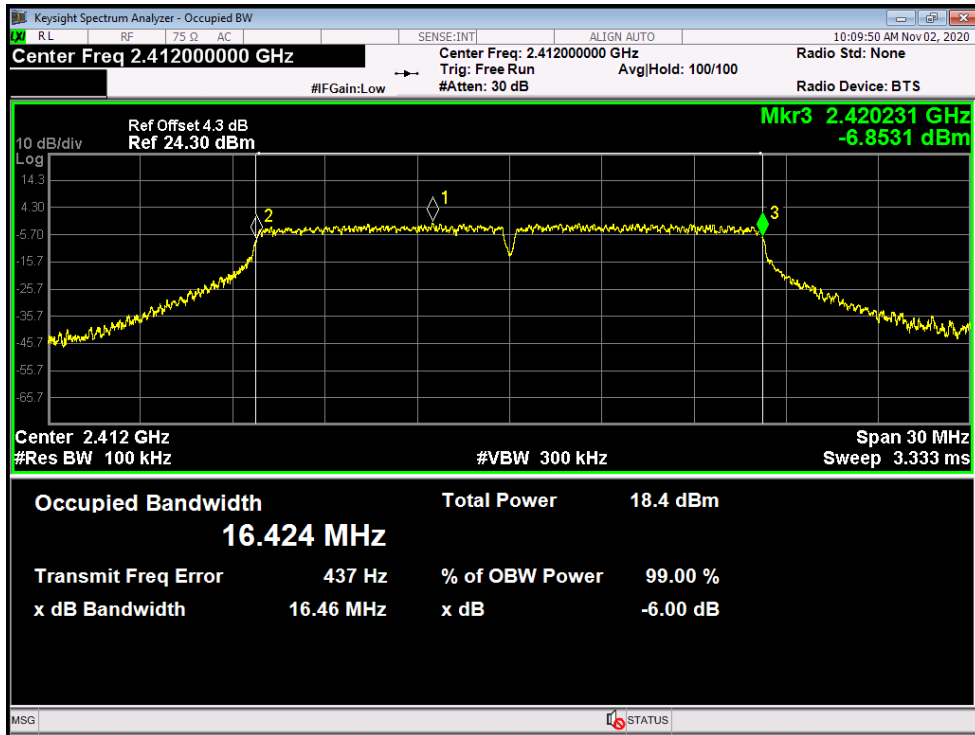

802.11G Mode

2437 MHz

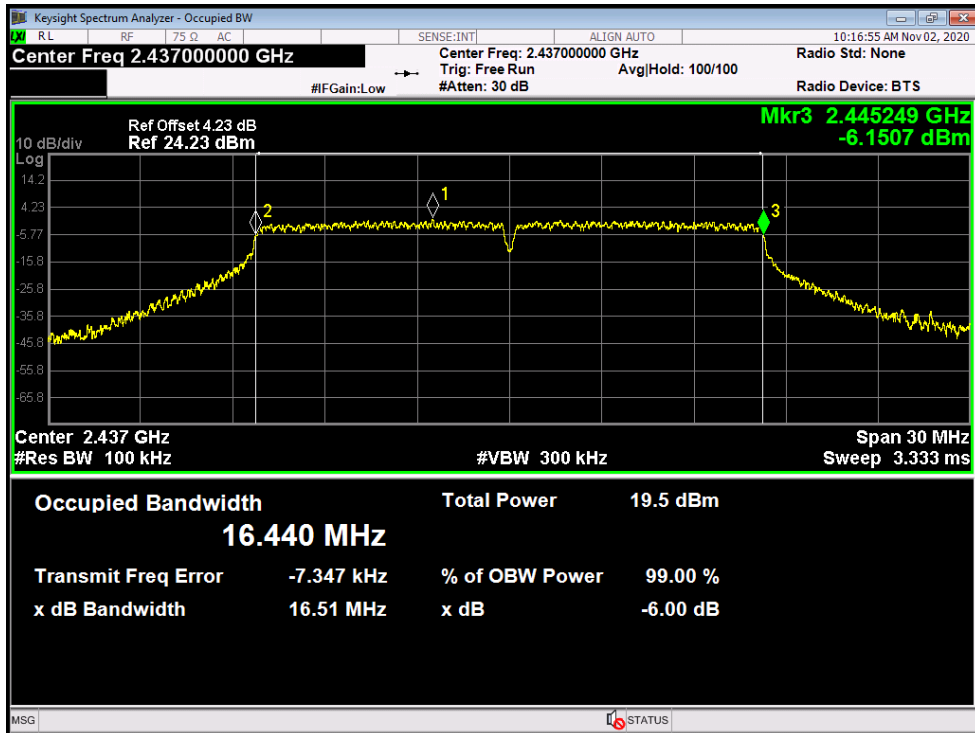

802.11G Mode

2462 MHz

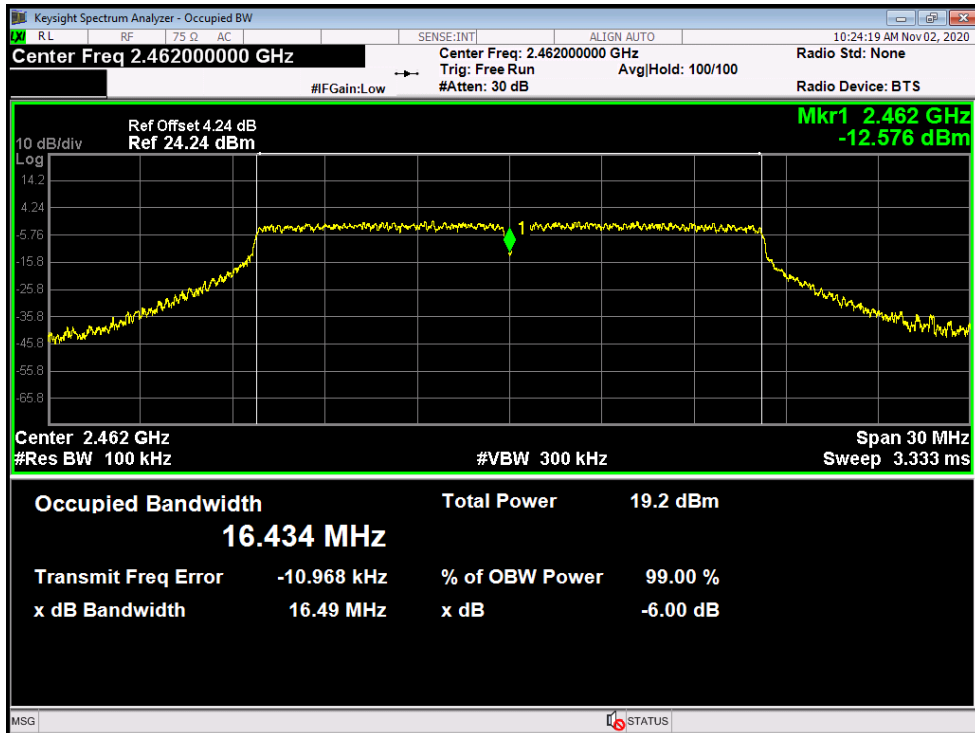

Temperature:	25°C	Relative Humidity:	55%
Test Voltage:	AC 120V/60HZ		
Test Mode:	TX 802.11N(HT20) Mode		
Channel frequency (MHz)	6dB Bandwidth (MHz)	99% Bandwidth (MHz)	Limit (MHz)
2412	17.73	17.649	>=0.5
2437	17.72	17.647	
2462	17.66	17.631	

802.11N(HT20) Mode

2412 MHz

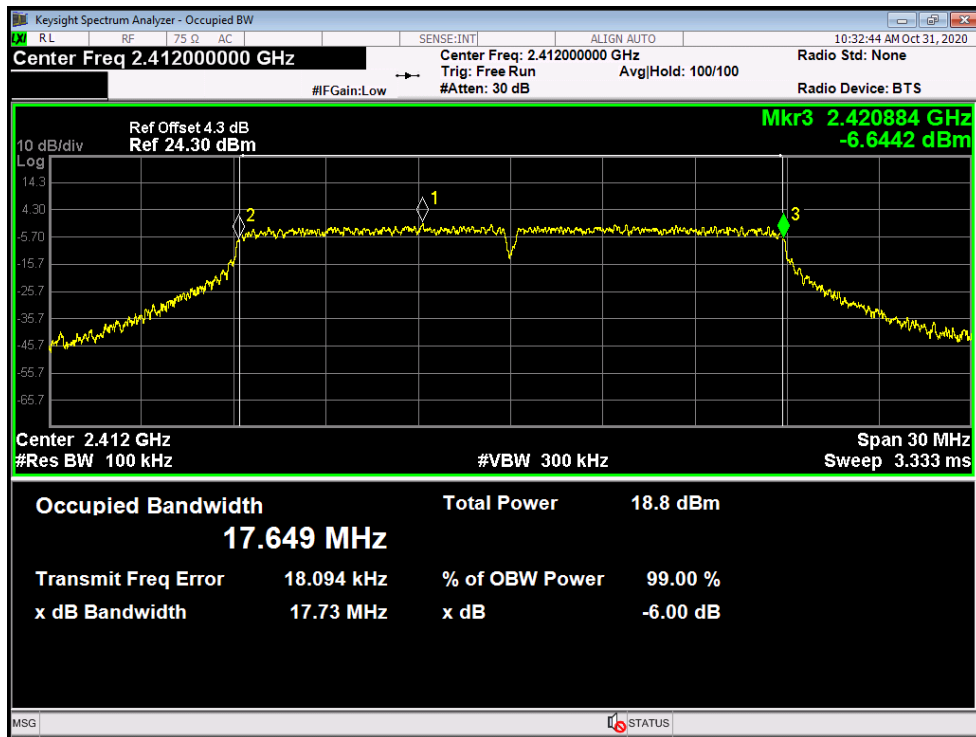

802.11N(HT20) Mode
2437 MHz

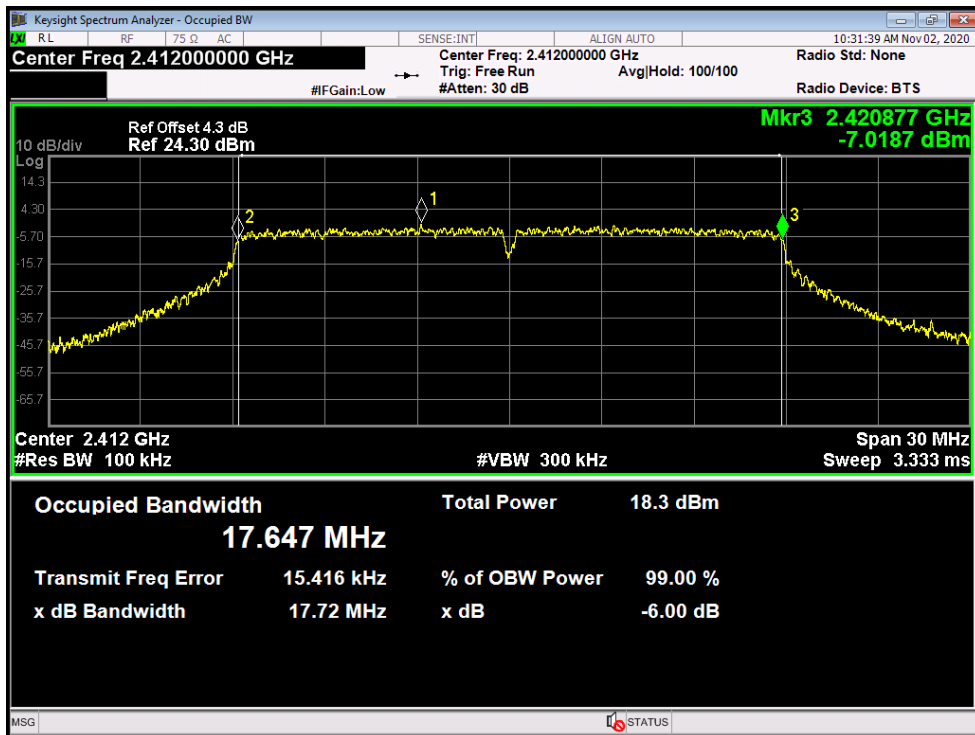

802.11N(HT20) Mode
2462 MHz

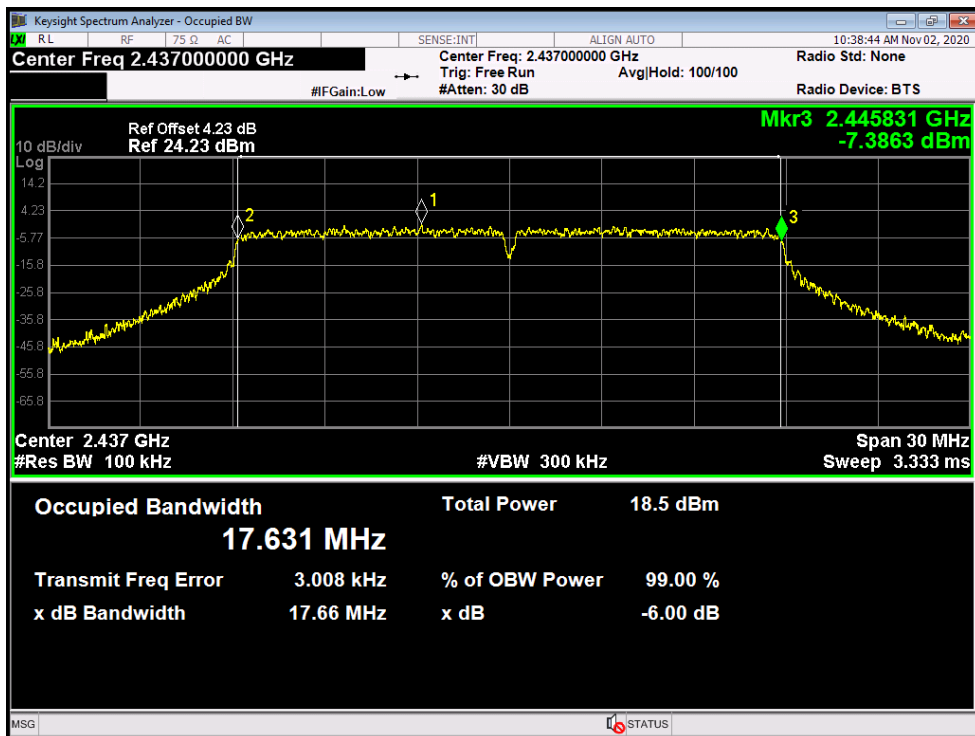

Temperature:	25°C	Relative Humidity:	55%
Test Voltage:	AC 120V/60HZ		
Test Mode:	TX 802.11N(HT40) Mode		
Channel frequency (MHz)	6dB Bandwidth (MHz)	99% Bandwidth (MHz)	Limit (MHz)
2412	36.35	35.862	>=0.5
2437	36.35	35.868	
2462	36.34	35.839	

802.11N(HT20) Mode

2412 MHz

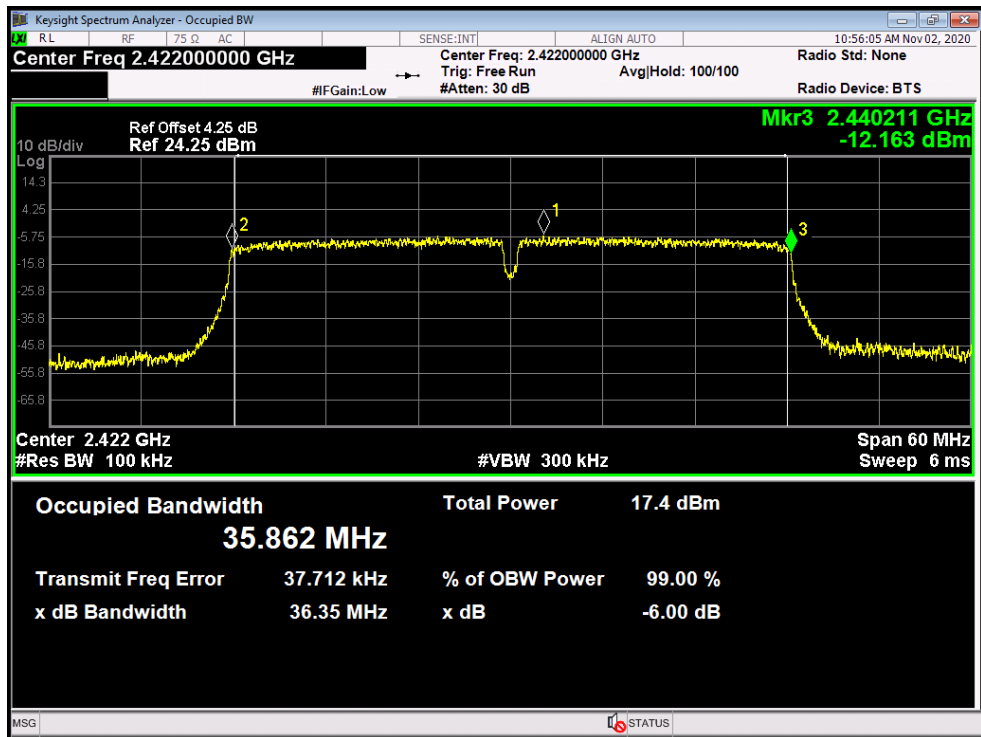

802.11N(HT20) Mode
2437 MHz

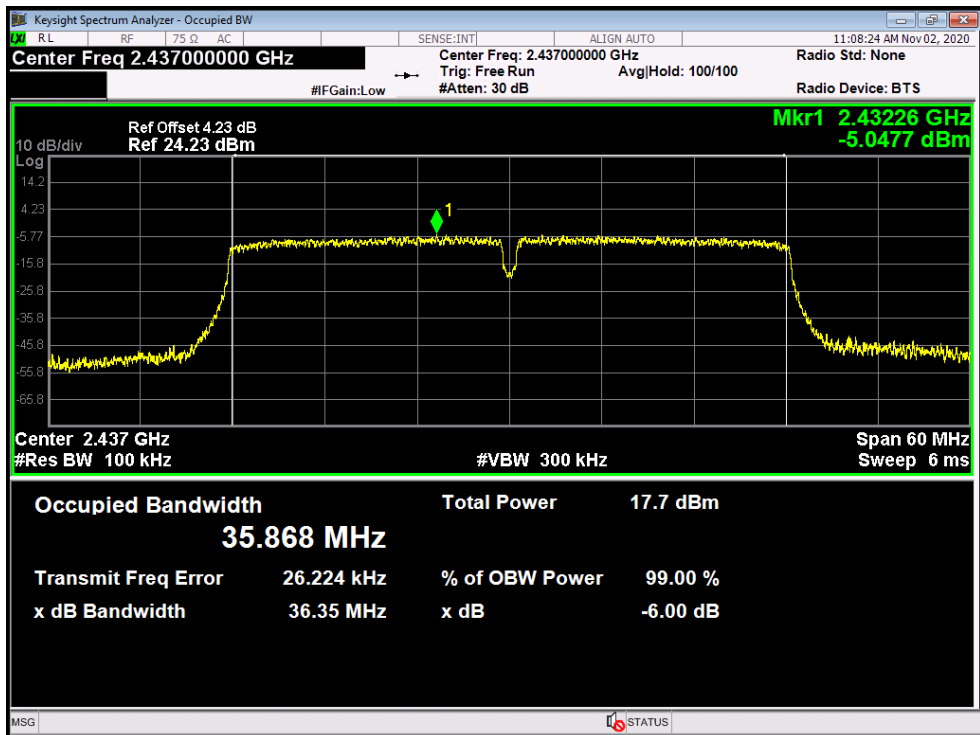

802.11N(HT20) Mode
2462 MHz

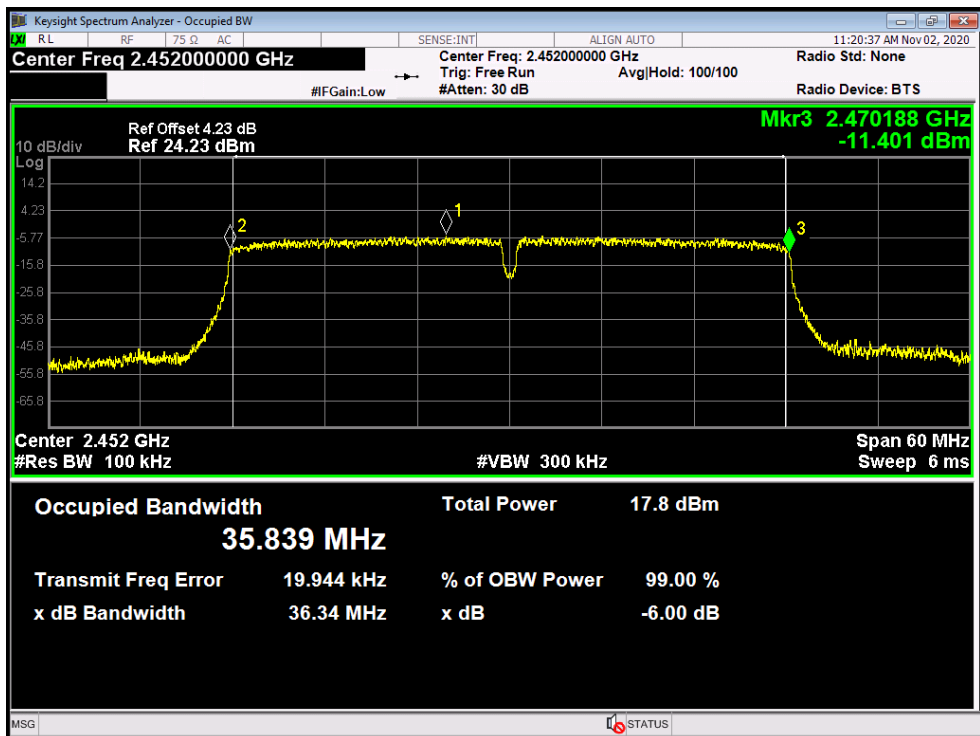

Attachment E-- Peak Output Power Test Data

Temperature:	25 °C	Relative Humidity:	55%
Test Voltage:	AC 120/60Hz		
Mode	Channel frequency (MHz)	Test Result (dBm)	Limit (dBm)
802.11b	2412	15.031	30
	2437	14.892	
	2462	14.728	
802.11g	2412	12.982	
	2437	14.022	
	2462	13.743	
802.11n (HT20)	2412	13.436	
	2437	13.095	
	2462	13.171	
802.11n (HT40)	2412	11.817	
	2437	12.062	
	2462	12.189	
Result: PASS			

Duty Cycle		
Mode	Channel frequency (MHz)	Test Result
802.11b	2412	>98%
	2437	
	2462	
802.11g	2412	
	2437	
	2462	
802.11n (HT20)	2412	
	2437	
	2462	
802.11n (HT40)	2422	
	2437	
	2452	
Please see below plots.		

802.11 B Mode 2437 MHz

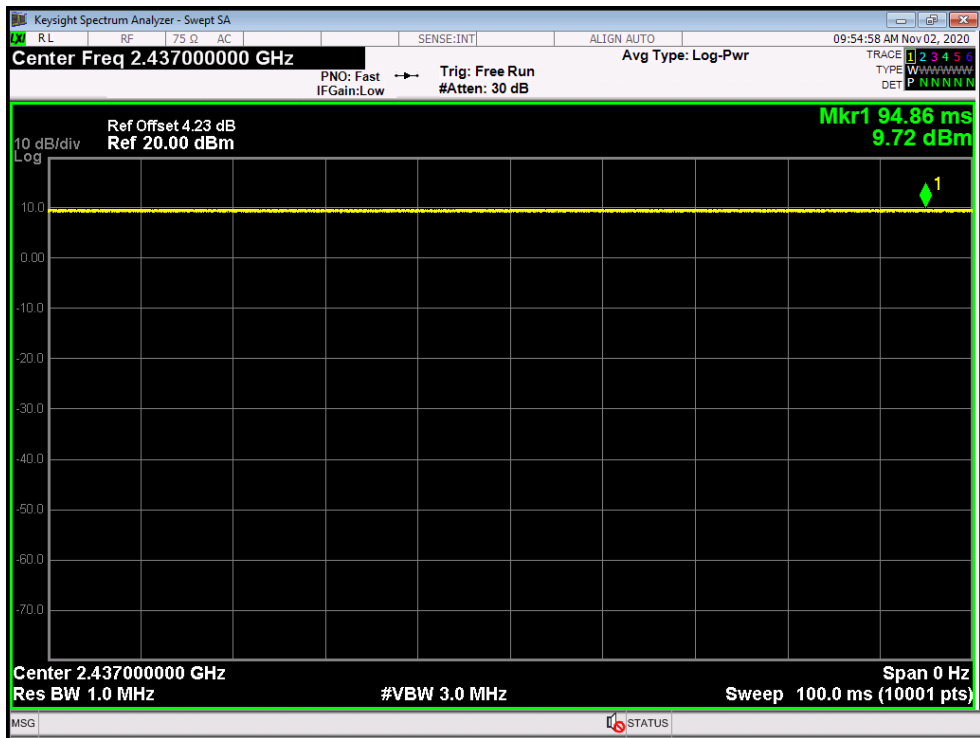

802.11 G Mode 2437 MHz

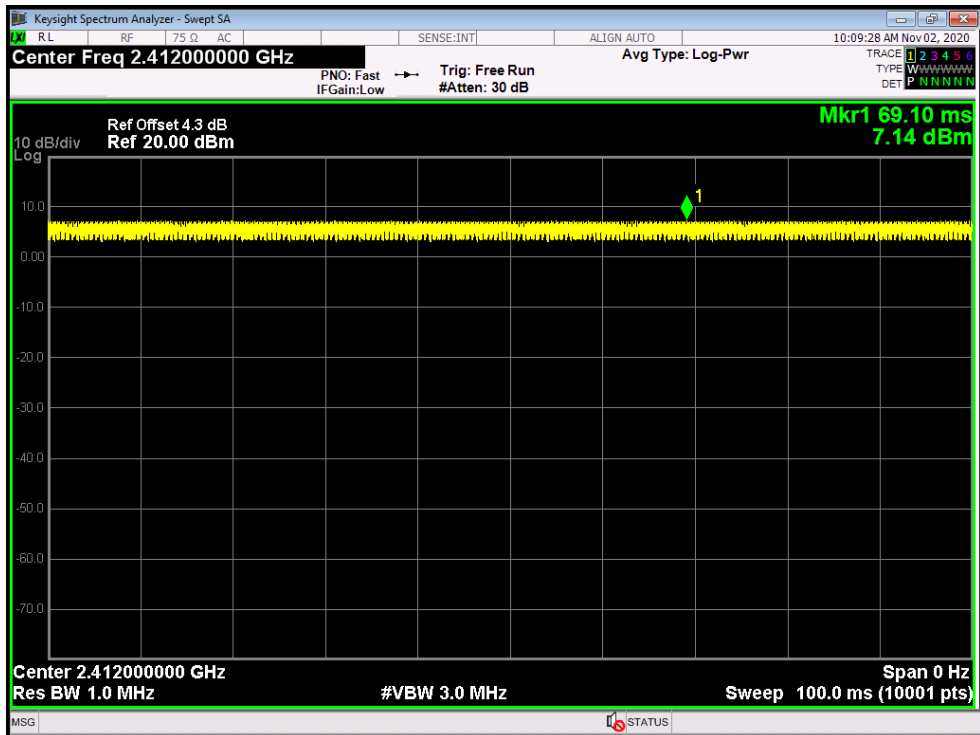

802.11 N(HT20) Mode 2437 MHz

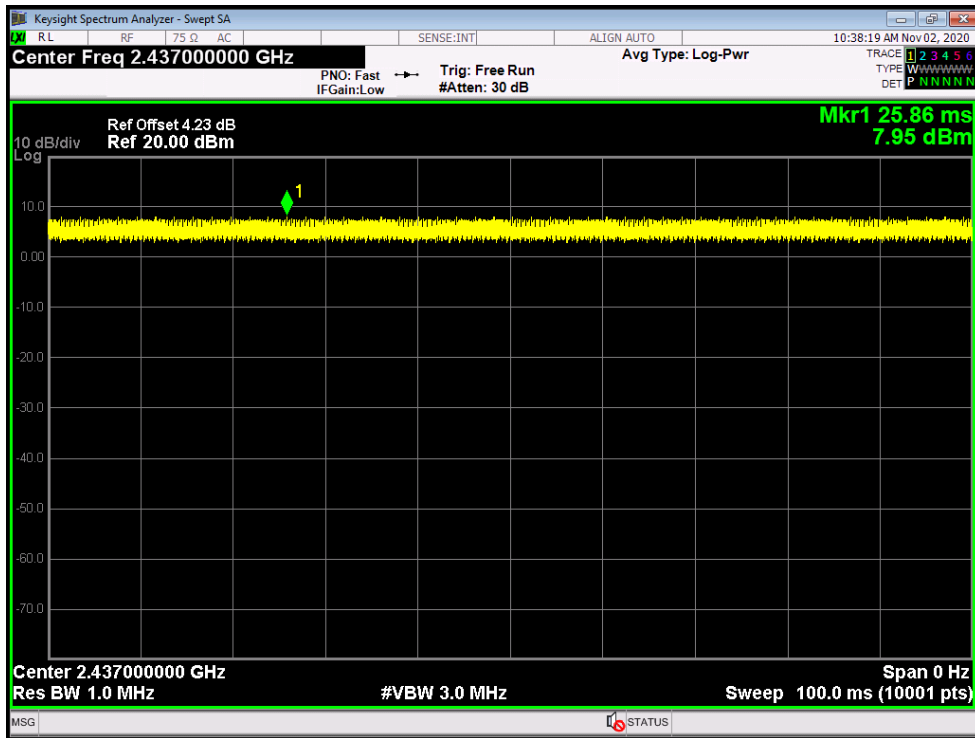

802.11 N(HT40) Mode 2437 MHz

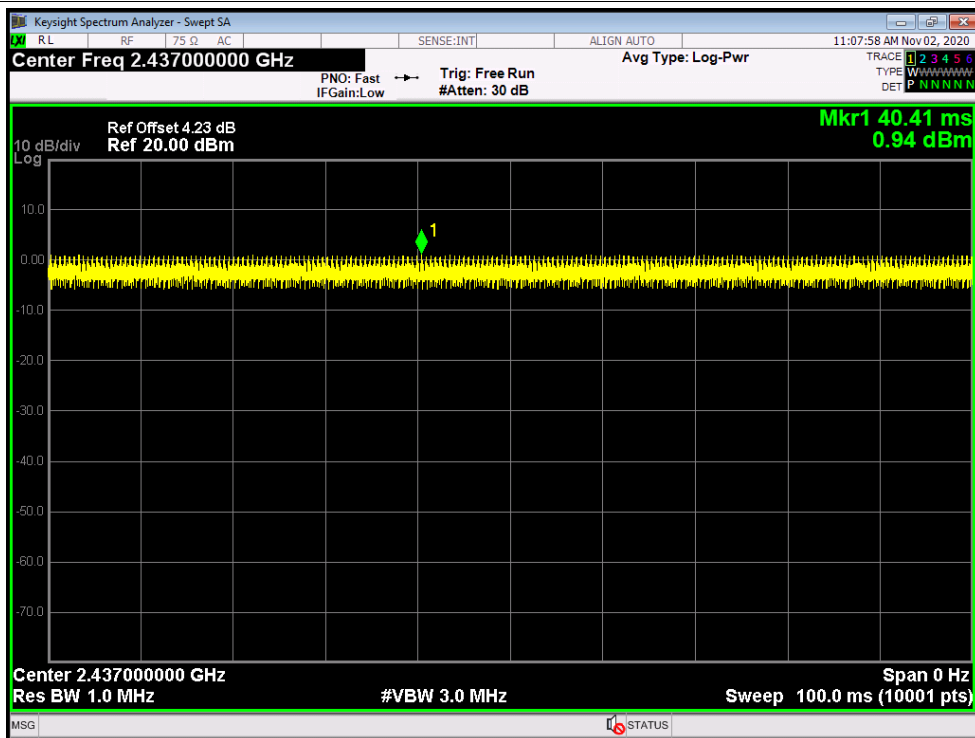

Attachment F-- Power Spectral Density Test Data

Temperature:	25 °C	Relative Humidity:	55%
Test Voltage:	AC 120V/60 HZ		
Test Mode:	TX 802.11B Mode		
Channel Frequency (MHz)	Power Density (dBm/3 kHz)	Limit (dBm/3 kHz)	
2412	-14.818	8	
2437	-14.891		
2462	-15.026		

802.11B Mode

2412 MHz

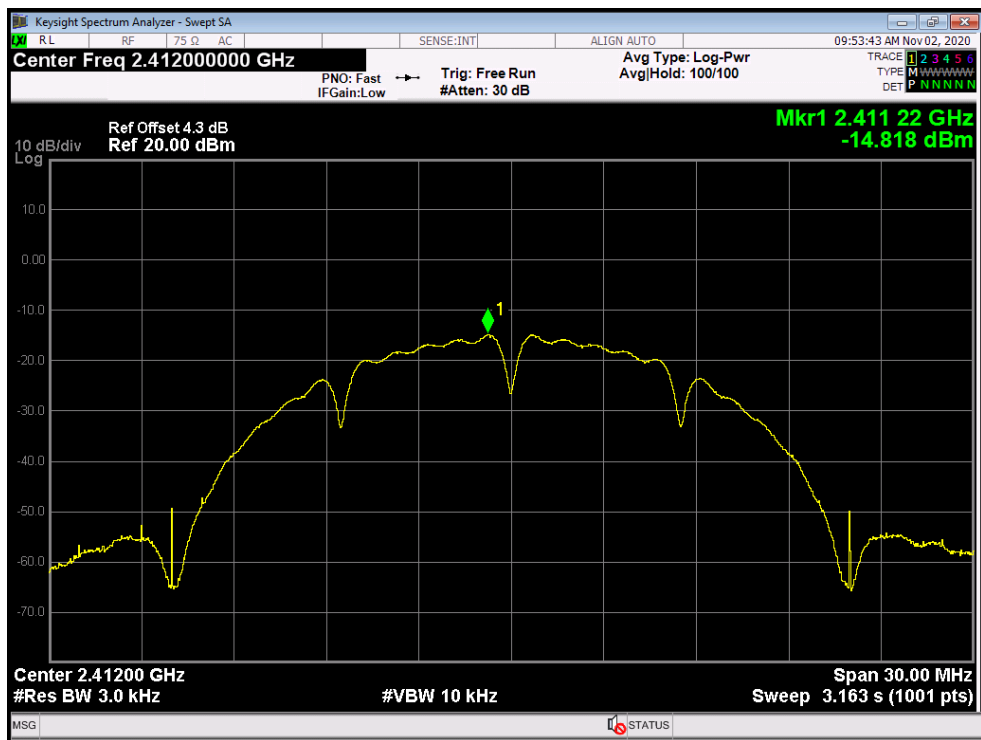

802.11B Mode

2437 MHz

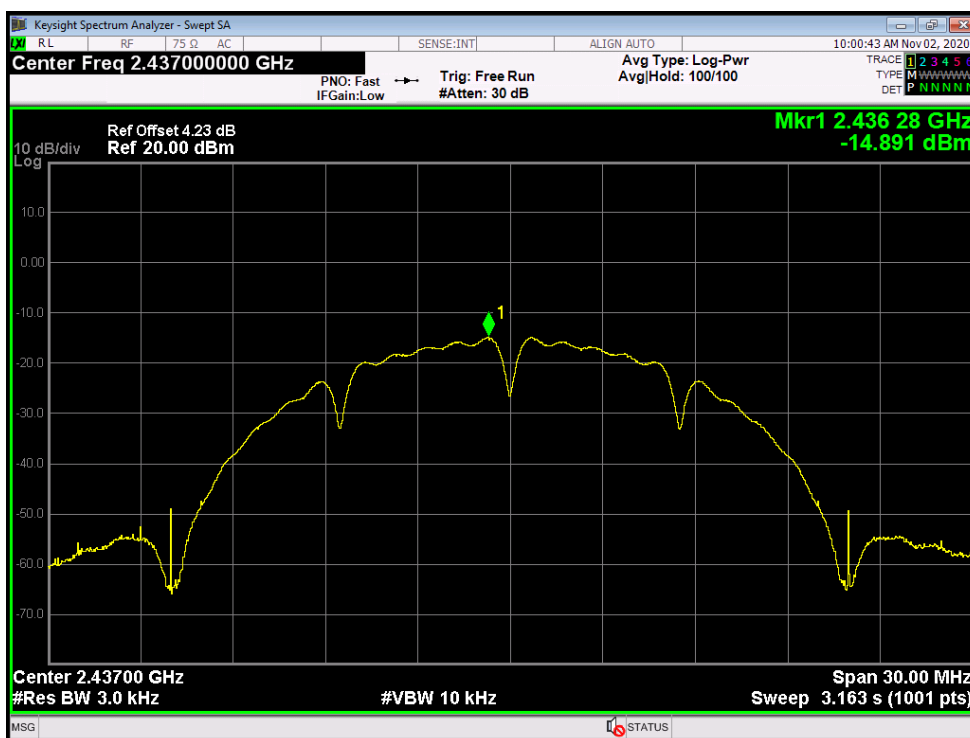

802.11B Mode

2462 MHz

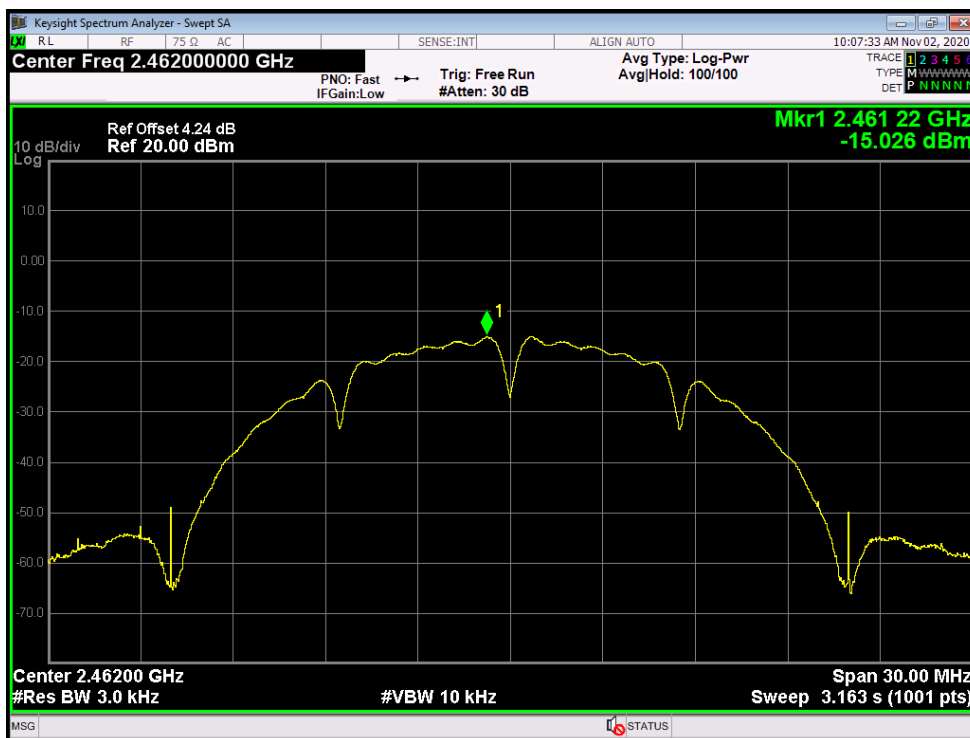

Temperature:	25 °C	Temperature:	25 °C
Test Voltage:	AC 120V/60 HZ		
Test Mode:	TX 802.11G Mode		
Channel Frequency (MHz)	Power Density (dBm/3 kHz)	Limit (dBm/3 kHz)	
2412	-15.466	8	
2437	-14.382		
2462	-14.592		

802.11G Mode

2412 MHz

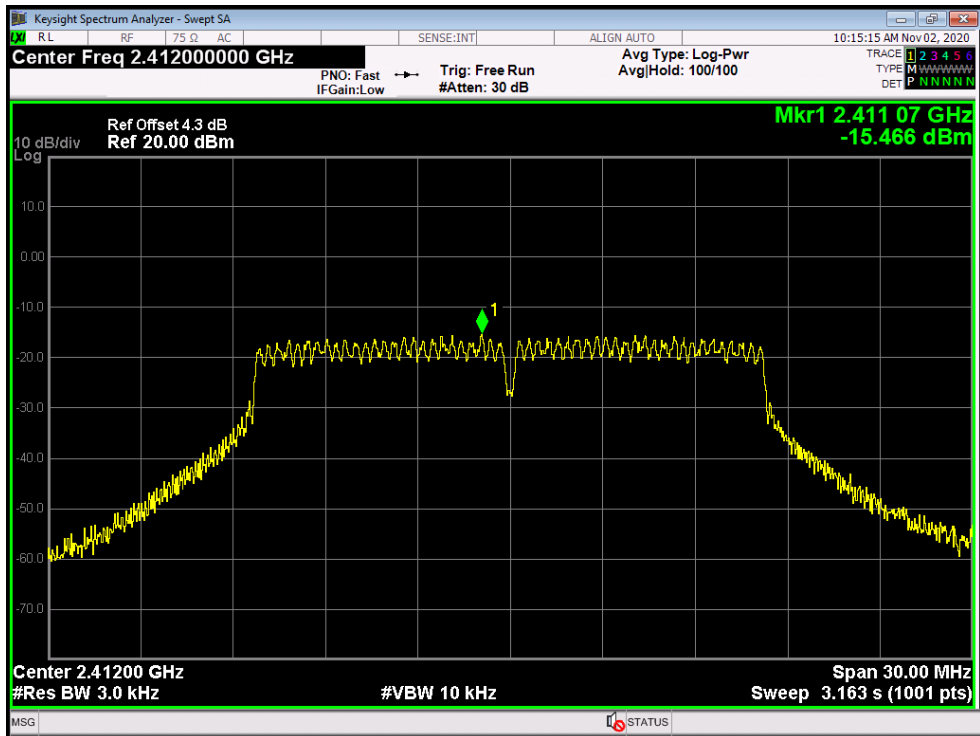

802.11G Mode

2437 MHz

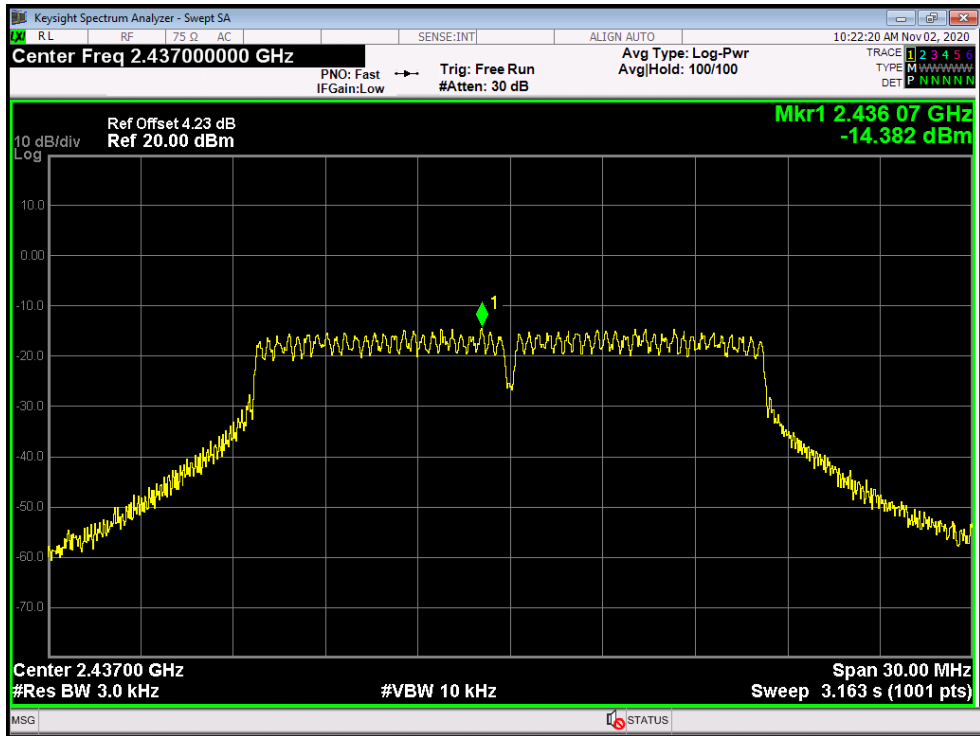

802.11G Mode

2462 MHz

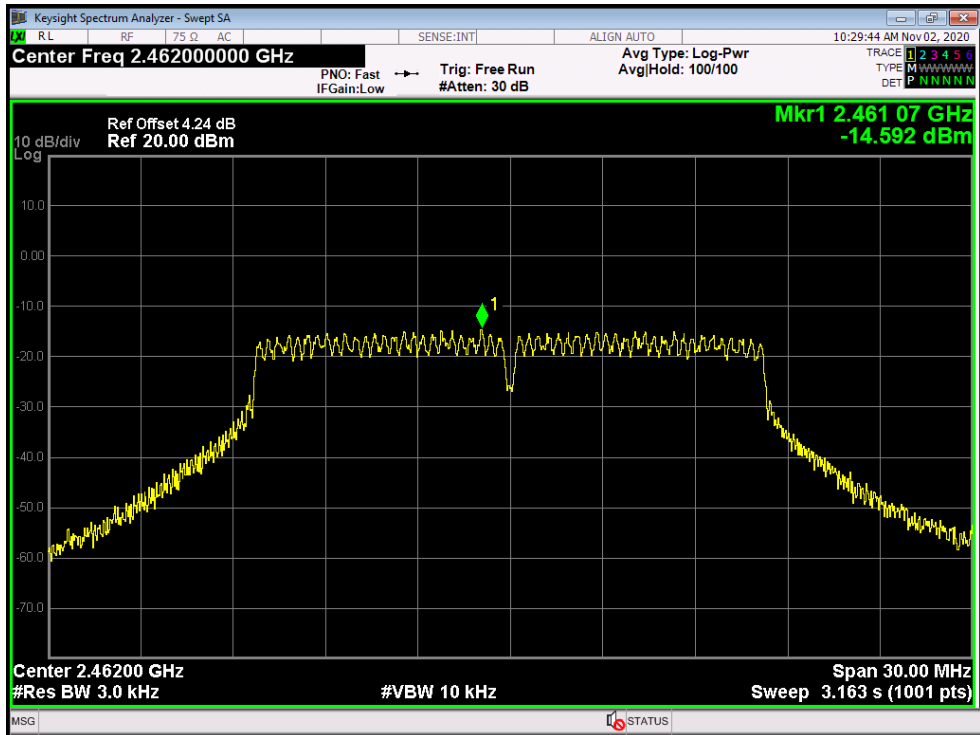

Temperature:	25 °C	Temperature:	25 °C
Test Voltage:	AC 120V/60 HZ		
Test Mode:	TX 802.11N(HT20) Mode		
Channel Frequency (MHz)	Power Density (dBm/3 kHz)	Limit (dBm/3 kHz)	
2412	-15.405	8	
2437	-15.036		
2462	-14.879		
802.11N(HT20) Mode			

2412 MHz

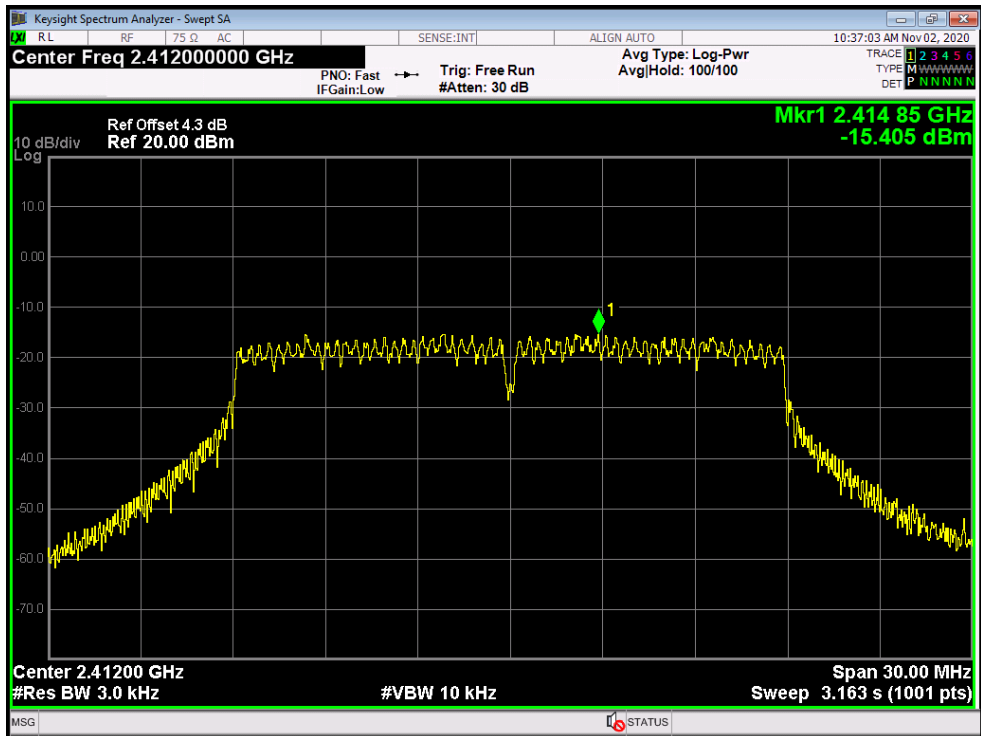

802.11N(HT20) Mode

2437 MHz

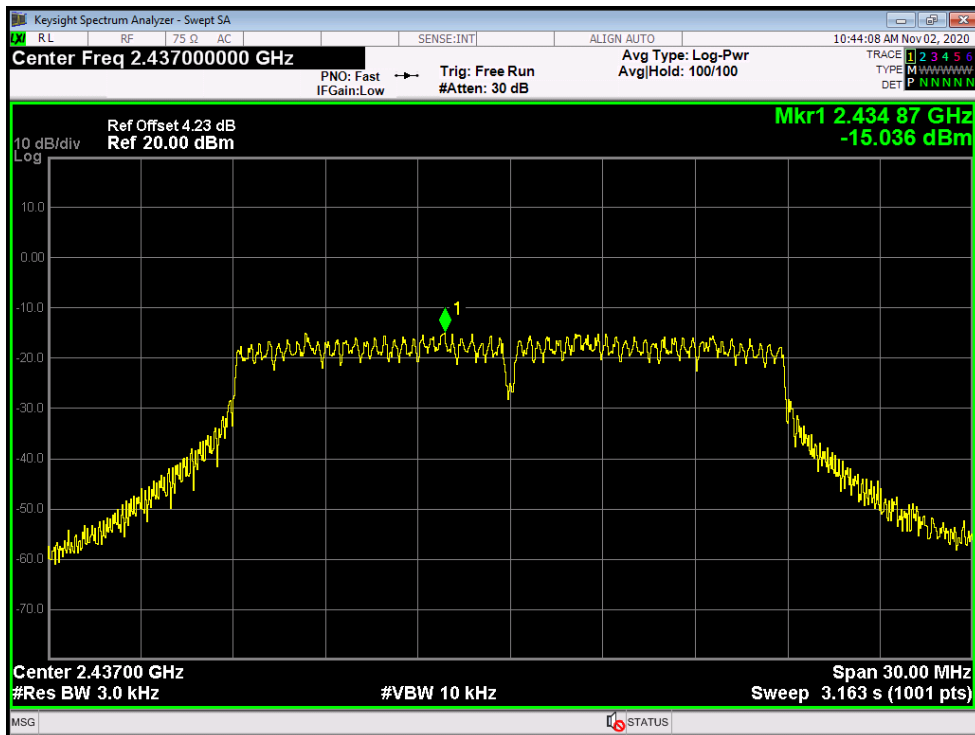

802.11N(HT20) Mode

2462 MHz

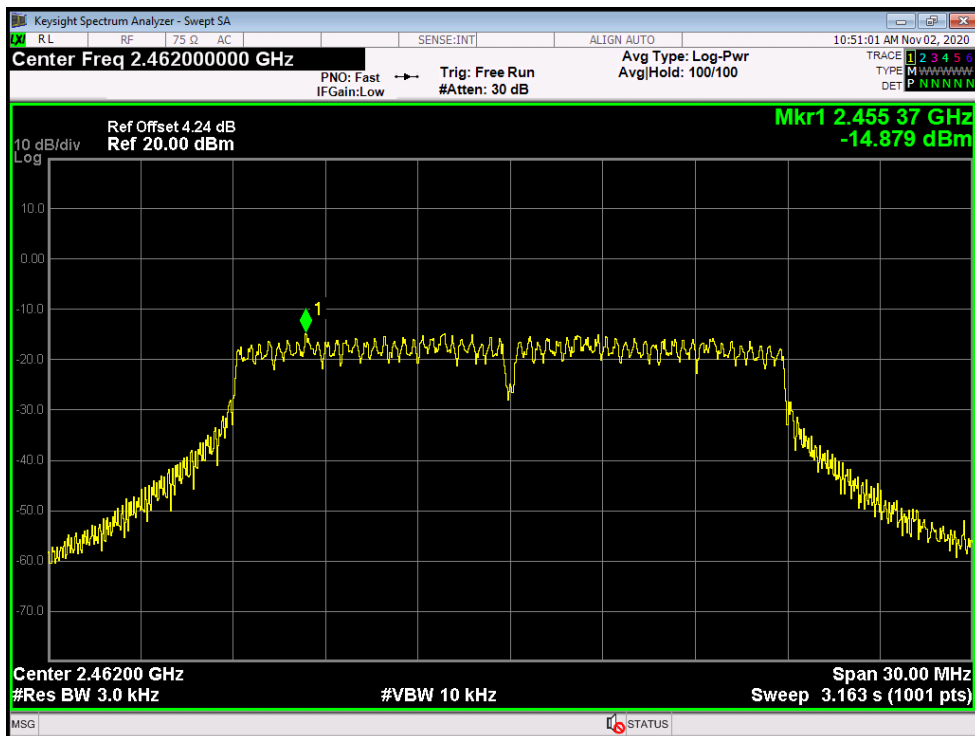

Temperature:	25 °C	Temperature:	25 °C
Test Voltage:	AC 120V/60 HZ		
Test Mode:	TX 802.11N(HT40) Mode		
Channel Frequency (MHz)	Power Density (dBm/3 kHz)	Limit (dBm/3 kHz)	
2422	-16.186	8	
2437	-15.566		
2452	-15.459		
802.11N(HT40) Mode			

2422 MHz

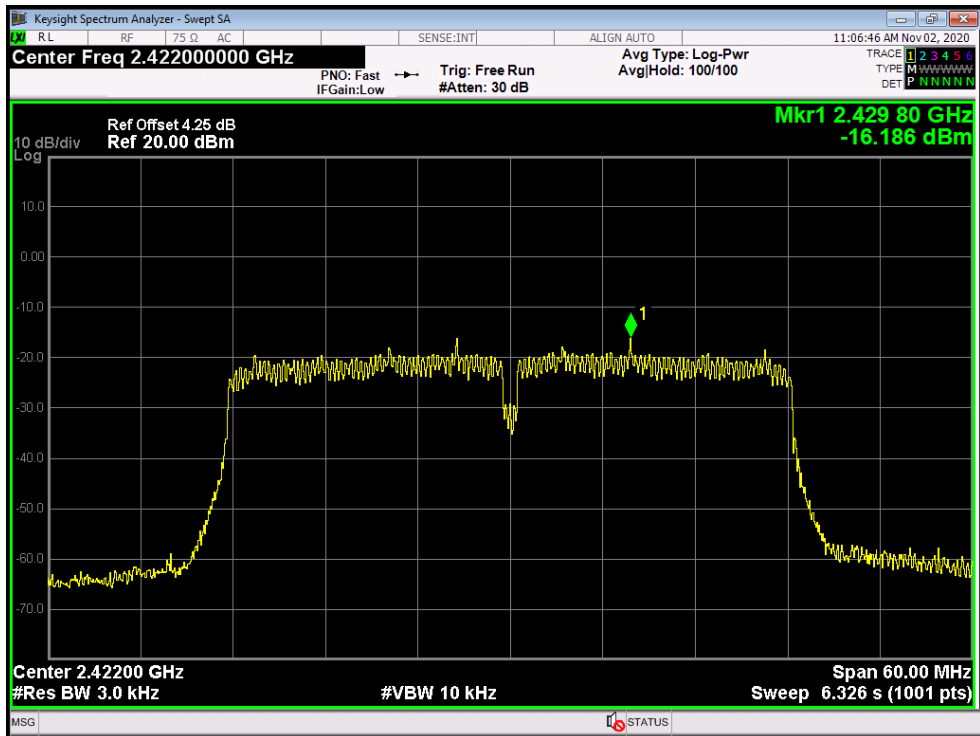

**802.11N(HT40) Mode
2437 MHz**

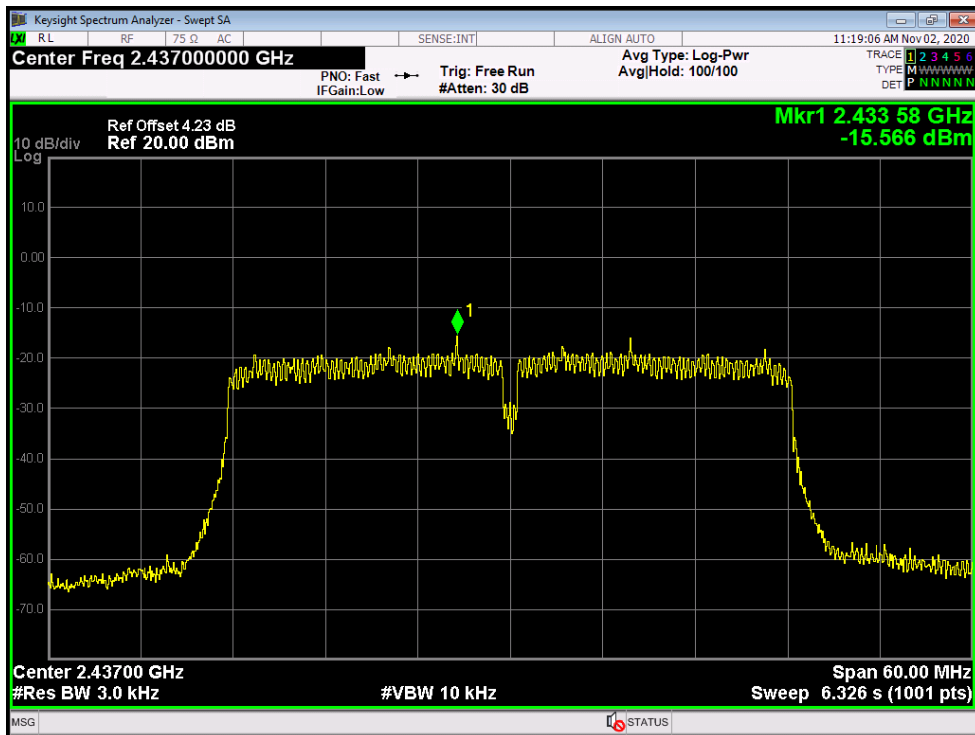

**802.11N(HT40) Mode
2452 MHz**

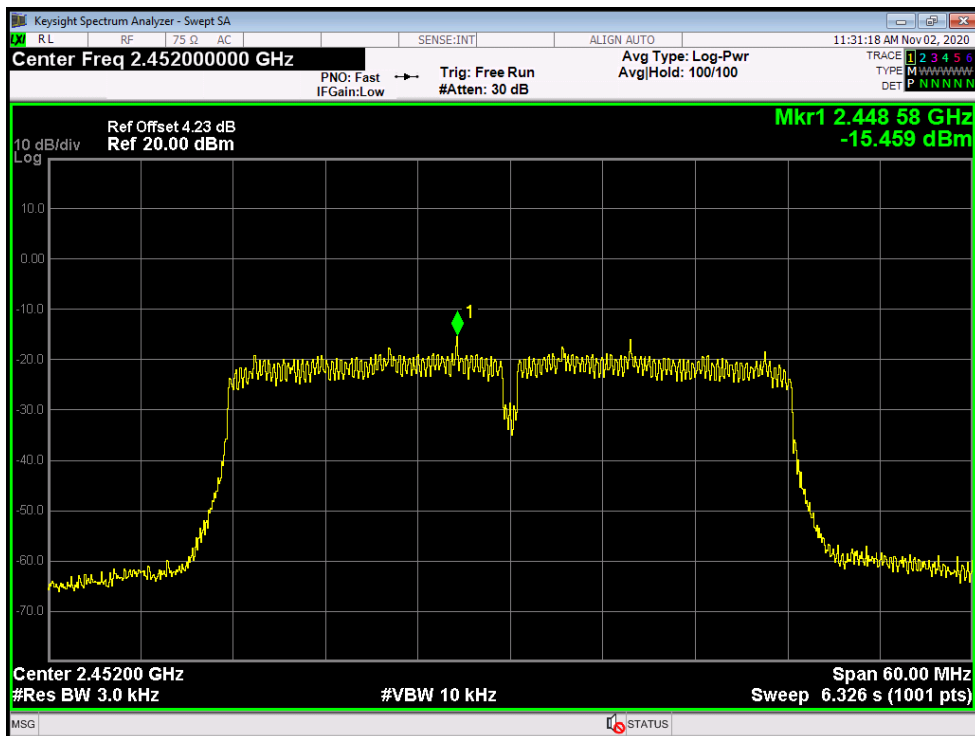

-----END OF REPORT-----