

# RADIO TEST REPORT

## FCC ID: 2ATPO-RA-01

**Product:** LoRa Module

**Trade Mark:**  , 

**Model No.:** Ra-01

**Family Model:** N/A

**Report No.:** S20031100207001

**Issue Date:** 26 Apr. 2020

### Prepared for

Shenzhen Ai-Thinker Technology Co., Ltd  
Room 701, Building B, Huafeng Industrial Park, Hangkong Road, Sanwei  
Community, Baoan District, Shenzhen, China

### Prepared by

Shenzhen NTEK Testing Technology Co., Ltd.  
1/F, Building E, Fenda Science Park, Sanwei Community,  
Xixiang Street Bao'an District, Shenzhen 518126 P.R. China  
Tel.: +86-755-6115 6588  
Fax.: +86-755-6115 6599  
Website: <http://www.ntek.org.cn>

<b>Table of Contents</b>	<b>Page</b>
<b>1.TEST RESULT CERTIFICATION</b>	<b>3</b>
<b>2. SUMMARY OF TEST RESULTS</b>	<b>4</b>
<b>3.FACILITIES AND ACCREDITATIONS</b>	<b>5</b>
3.1 FACILITIES	5
3.2 LABORATORY ACCREDITATIONS AND LISTINGS	5
3.3 MEASUREMENT UNCERTAINTY	5
<b>4. GENERAL DESCRIPTION OF EUT</b>	<b>6</b>
<b>5. DESCRIPTION OF TEST MODES</b>	<b>9</b>
<b>6. SETUP OF EQUIPMENT UNDER TEST</b>	<b>10</b>
6.1 BLOCK DIAGRAM CONFIGURATION OF TEST SYSTEM	10
6.2 DESCRIPTION OF SUPPORT UNITS(CONDUCTED MODE)	11
6.3 EQUIPMENTS LIST FOR ALL TEST ITEMS	12
<b>7. ANTENNA REQUIREMENT</b>	<b>13</b>
7.1 STANDARD REQUIREMENT	13
7.2 EUT ANTENNA	13
<b>8. CONDUCTED EMISSION MEASUREMENT</b>	<b>14</b>
8.1 APPLICABLE STANDARD	14
8.2 CONFORMANCE LIMIT	14
8.3 MEASURING INSTRUMENTS	14
8.4 TEST CONFIGURATION	14
8.5 TEST PROCEDURE	14
8.6 TEST RESULTS	15
<b>9. RADIATED EMISSION MEASUREMENT</b>	<b>17</b>
9.1 APPLICABLE STANDARD	17
9.2 RADIATED EMISSION LIMITS	17
9.3 TEST PROCEDURE	19
9.4 TEST SETUP	21
9.5 TEST RESULTS	22
<b>10. BANDWIDTH TEST</b>	<b>36</b>
10.1 TEST PROCEDURE	36
10.2 DEVIATION FROM STANDARD	36
10.3 TEST SETUP	36
10.4 TEST RESULTS	37
<b>11. TRANSMITTER TIMEOUT</b>	<b>39</b>
11.1 REQUIREMENTS	39

**1. TEST RESULT CERTIFICATION**

Applicant's name..... :	Shenzhen Ai-Thinker Technology Co., Ltd
Address..... :	Room 701, Building B, Huafeng Industrial Park, Hangkong Road, Sanwei Community, Baoan District, Shenzhen, China
Manufacturer's Name..... :	Shenzhen Ai-Thinker Technology Co., Ltd
Address..... :	Room 701, Building B, Huafeng Industrial Park, Hangkong Road, Sanwei Community, Baoan District, Shenzhen, China
Product description	
Product name..... :	LoRa Module
Model and/or type reference..... :	Ra-01
Family Model..... :	N/A

Measurement Procedure Used:

<b>APPLICABLE STANDARDS</b>	
<b>APPLICABLE STANDARD/ TEST PROCEDURE</b>	<b>TEST RESULT</b>
FCC 47 CFR Part 15, Subpart C ANSI C63.10-2013	<b>Complied</b>

This device described above has been tested by Shenzhen NTEK Testing Technology Co., Ltd., and the test results show that the equipment under test (EUT) is in compliance with the FCC requirements. And it is applicable only to the tested sample identified in the report.

This report shall not be reproduced except in full, without the written approval of Shenzhen NTEK Testing Technology Co., Ltd., this document may be altered or revised by Shenzhen NTEK Testing Technology Co., Ltd. personnel only, and shall be noted in the revision of the document.

The test results of this report relate only to the tested sample identified in this report.

Date of Test : 11 Mar. 2020 ~23 Apr. 2020

Testing Engineer : Jerry Xie  
(Jerry Xie)

Technical Manager : Jason Chen  
(Jason Chen)

Authorized Signatory : Sam. Chen  
(Sam Chen)

**2. SUMMARY OF TEST RESULTS**

<b>FCC Part15 (15.231), Subpart C</b>			
Standard Section	Test Item	Judgment	Remark
15.207	Conducted Emission	Pass	
15.203	Antenna Requirement	Pass	
15.231(b) 15.209 15.205	Radiated Spurious Emission	Pass	
15.231(c)	Occupied Bandwidth	Pass	
15.231(a)(2)	Transmitter Timeout	Pass	

**NOTE:**

- (1) " N/A" denotes test is not applicable in this Test Report.
- (2) The EUT is using a new battery

### 3.FACILITIES AND ACCREDITATIONS

#### 3.1 FACILITIES

All measurement facilities used to collect the measurement data are located at  
 1/F, Building E, Fenda Science Park, Sanwei Community, Xixiang Street, Bao'an District, Shenzhen 518126  
 P.R. China  
 The sites are constructed in conformance with the requirements of ANSI C63.7, ANSI C63.10 and CISPR  
 Publication 22.

#### 3.2 LABORATORY ACCREDITATIONS AND LISTINGS

##### Site Description



- CNAS-Lab. : The Laboratory has been assessed and proved to be in compliance with  
 CNAS-CL01:2006 (identical to ISO/IEC 17025:2005)  
 The Certificate Registration Number is L5516.
- IC-Registration : The Certificate Registration Number is 9270A.  
 CAB identifier:CN0074
- FCC- Accredited : Test Firm Registration Number: 463705.  
 Designation Number: CN1184
- A2LA-Lab. : The Certificate Registration Number is 4298.01  
 This laboratory is accredited in accordance with the recognized  
 International Standard ISO/IEC 17025:2005 General requirements for  
 the competence of testing and calibration laboratories.  
 This accreditation demonstrates technical competence for a defined  
 scope and the operation of a laboratory quality management system  
 (refer to joint ISO-ILAC-IAF Communiqué dated 8 January 2009).
- Name of Firm : Shenzhen NTEK Testing Technology Co., Ltd.
- Site Location : 1/F, Building E, Fenda Science Park, Sanwei Community, Xixiang  
 Street, Bao'an District, Shenzhen 518126 P.R. China.

#### 3.3 MEASUREMENT UNCERTAINTY

The reported uncertainty of measurement  $y \pm U$ , where expanded uncertainty  $U$  is based on a standard  
 uncertainty multiplied by a coverage factor of  $k=2$ , providing a level of confidence of approximately 95 %.

No.	Item	Uncertainty
1	Conducted Emission Test	$\pm 2.80\text{dB}$
2	RF power, conducted	$\pm 0.16\text{dB}$
3	Spurious emissions, conducted	$\pm 0.21\text{dB}$
4	All emissions, radiated(30MHz~1GHz)	$\pm 2.64\text{dB}$
5	All emissions, radiated(1GHz~6GHz)	$\pm 2.40\text{dB}$
6	All emissions, radiated(> 6GHz)	$\pm 2.52\text{dB}$
7	Temperature	$\pm 0.5^\circ\text{C}$
8	Humidity	$\pm 2\%$

**4. GENERAL DESCRIPTION OF EUT**

Equipment	LoRa Module
Trade Name	 
Model Name	Ra-01
Family Model	N/A
Model Difference	N/A
Product Description	The EUT is a LoRa Module
	Operation Frequency: 411-525MHz
	Modulation Type: LoRa/FSK/OOK
	Number Of Channel 115CH
	Antenna Designation: Spring Antenna
	Antenna Gain: 3dBi
	Field Strength: 60.38dBuV/m
	Based on the application, features, or specification exhibited in User's Manual, the EUT is considered as an ITE/Computing Device. More details of EUT technical specification, please refer to the User's Manual.
Channel List	Refer to below
Power supply	DC 3.3V form Uart
Adapter	N/A
Battery	N/A
HW Version	V3.2
FW Version	V1.00

Note:

1. For a more detailed features description, please refer to the manufacturer's specifications or the User's Manual.

2. Channel List:

Channel	Frequency (MHz)
01	411MHz
02	412MHz
--	--
57	467 MHz
58	468 MHz
--	--
114	524 MHz
115	525 MHz

3. Test Channel:

Channel	Frequency (MHz)
01	411 MHz
58	468 MHz
115	525 MHz





**5. DESCRIPTION OF TEST MODES**

To investigate the maximum EMI emission characteristics generates from EUT, the test system was pre-scanning tested base on the consideration of following EUT operation mode or test configuration mode which possible have effect on EMI emission level. Each of these EUT operation mode(s) or test configuration mode(s) mentioned above was evaluated respectively.

Pretest Mode	Description
Mode 1	Channel 01 FSK TX
Mode 2	Channel 58 FSK TX
Mode 3	Channel 115 FSK TX

For Radiated Emission	
Final Test Mode	Description
Mode 1	Channel 01 FSK TX
Mode 2	Channel 58 FSK TX
Mode 3	Channel 115 FSK TX

## 6. SETUP OF EQUIPMENT UNDER TEST

### 6.1 BLOCK DIAGRAM CONFIGURATION OF TEST SYSTEM

For Radiated Test Cases

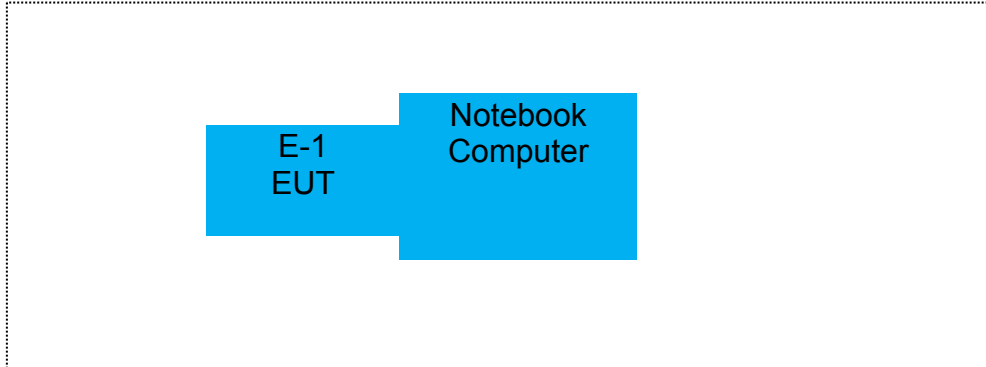

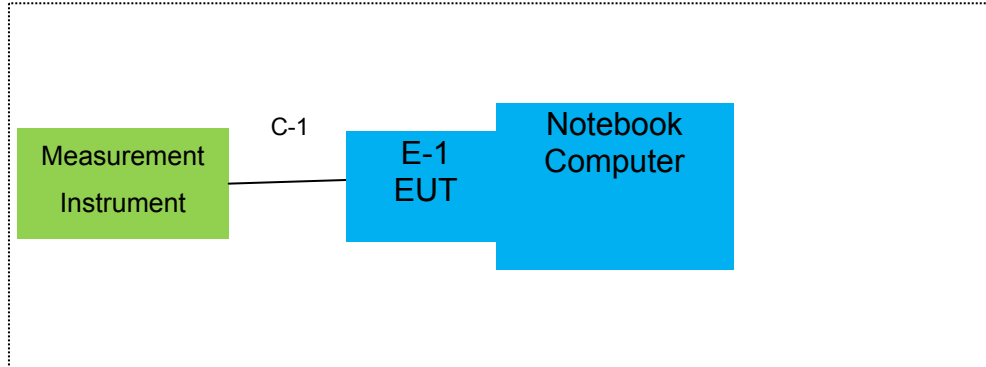

For Conducted Test Cases



Note: The temporary antenna connector is soldered on the PCB board in order to perform conducted tests and this temporary antenna connector is listed in the equipment list.

**6.2 DESCRIPTION OF SUPPORT UNITS(CONDUCTED MODE)**

The EUT has been tested as an independent unit together with other necessary accessories or support units. The following support units or accessories were used to form a representative test configuration during the tests.

Item	Equipment	Mfr/Brand	Model/Type No.	Series No.	Note
E-1	LoRa Module	 , 	Ra-01	N/A	EUT

Item	Cable Type	Shielded Type	Ferrite Core	Length
C-1	RF Cable	Yes	NO	0.1m

**Note:**

- (1) The support equipment was authorized by Declaration of Confirmation.
- (2) For detachable type I/O cable should be specified the length in cm in 『Length』 column.
- (3) “YES” is means “shielded” “with core”; “NO” is means “unshielded” “without core”.

### 6.3 EQUIPMENTS LIST FOR ALL TEST ITEMS

#### Radiation Test equipment

Item	Kind of Equipment	Manufacturer	Type No.	Serial No.	Last calibration	Calibrated until	Calibration period
1	Spectrum Analyzer	Agilent	E4407B	MY45108040	2019.05.13	2020.05.12	1 year
2	Spectrum Analyzer	Agilent	N9020A	MY49100060	2019.08.28	2020.08.27	1 year
3	EMI Test Receiver	Agilent	N9038A	MY53227146	2019.08.28	2020.08.27	1 year
4	Test Receiver	R&S	ESPI	101318	2019.05.13	2020.05.12	1 year
5	Bilog Antenna	TESEQ	CBL6111D	31216	2019.05.13	2020.05.12	1 year
6	50Ω Coaxial Switch	Anritsu	MP59B	6200983705	2018.05.19	2020.05.18	2 year
7	Horn Antenna	EM	EM-AH-10180	2011071402	2019.05.13	2020.05.12	1 year
8	Horn Ant	Schwarzbeck	BBHA 9170	9170-181	2019.11.02	2020.11.01	1 year
9	Amplifier	EMC	EMC051835SE	980246	2019.08.06	2020.08.05	1 year
10	Amplifier	MITEQ	TTA1840-35-HG	177156	2019.11.02	2020.11.01	1 year
11	Loop Antenna	ARA	PLA-1030/B	1029	2019.08.06	2020.08.05	1 year
12	Power Meter	DARE	RPR3006W	15100041SN084	2020.04.19	2022.04.18	3 year
13	Test Cable (9KHz-30MHz)	N/A	R-01	N/A	2020.04.19	2022.04.18	3 year
14	Test Cable (30MHz-1GHz)	N/A	R-02	N/A	2020.04.19	2022.04.18	3 year
15	High Test Cable(1G-40G Hz)	N/A	R-03	N/A	2020.04.19	2022.04.18	3 year
16	High Test Cable(1G-40G Hz)	N/A	R-04	N/A	2020.04.19	2022.04.18	3 year
17	temporary antenna connector (Note)	NTS	R001	N/A	N/A	N/A	N/A

**Note:**

We will use the temporary antenna connector (soldered on the PCB board) When conducted test  
And this temporary antenna connector is listed within the instrument list

## **7. ANTENNA REQUIREMENT**

### **7.1 STANDARD REQUIREMENT**

15.203 requirement: For intentional device, according to 15.203: an intentional radiator shall be designed to ensure that no antenna other than that furnished by the responsible party shall be used with the device.

### **7.2 EUT ANTENNA**

The EUT antenna is permanent attached Spring Antenna (Gain: 3dBi). It comply with the standard requirement.

## 8. CONDUCTED EMISSION MEASUREMENT

### 8.1 Applicable Standard

According to FCC Part 15.207(a) and KDB 174176 D01 Line Conducted FAQ v01r01

### 8.2 Conformance Limit

Frequency(MHz)	Conducted Emission Limit	
	Quasi-peak	Average
0.15-0.5	66-56*	56-46*
0.5-5.0	56	46
5.0-30.0	60	50

Note: 1. \*Decreases with the logarithm of the frequency  
 2. The lower limit shall apply at the transition frequencies  
 3. The limit decreases in line with the logarithm of the frequency in the range of 0.15 to 0.50MHz.

### 8.3 Measuring Instruments

The Measuring equipment is listed in the section 6.3 of this test report.

### 8.4 Test Configuration

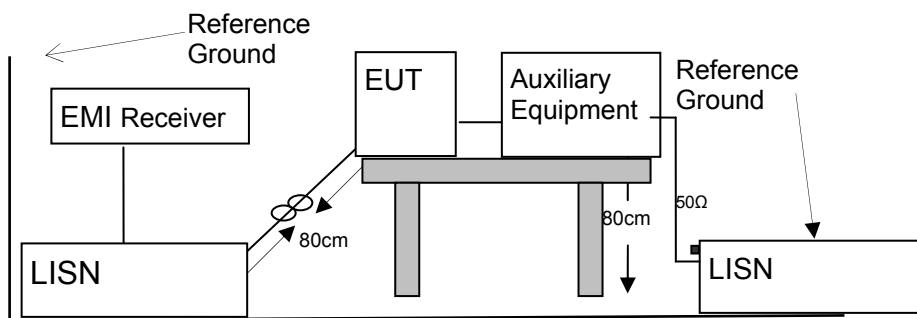

### 8.5 Test Procedure

According to the requirements in Section 13.1.4.1 of ANSI C63.10-2013 Conducted emissions the EUT measured in the frequency range between 0.15 MHz and 30 MHz using CISPR Quasi-Peak and average detector mode.

1. The EUT was placed 0.4 meter from the conducting wall of the shielding room.
2. The EUT was placed on a table which is 0.8m above ground plane.
3. Connect EUT to the power mains through a line impedance stabilization network (LISN). All other support equipments powered from additional LISN(s). The LISN provide 50 Ohm/ 50uH of coupling impedance for the measuring instrument.
4. Interconnecting cables that hang closer than 40 cm to the ground plane shall be folded back and forth in the center forming a bundle 30 to 40cm long.
5. I/O cables that are not connected to a peripheral shall be bundled in the center. The end of the cable may be terminated, if required, using the correct terminating impedance. The overall length shall not exceed 1 m.
6. LISN at least 80 cm from nearest part of EUT chassis.
7. The frequency range from 150KHz to 30MHz was searched.
8. Set the test-receiver system to Peak Detect Function and specified bandwidth(IF bandwidth=9KHz) with Maximum Hold Mode
9. For the actual test configuration, please refer to the related Item –EUT Test Photos.

**8.6 Test Results**

EUT :	LoRa Module	Model Name :	Ra-01
Temperature :	26 °C	Relative Humidity :	54%
Pressure :	1010hPa	Phase :	L
Test Voltage :	DC 3.3V by Control panel and Adapter AC 120V/60Hz	Test Mode :	Mode 1

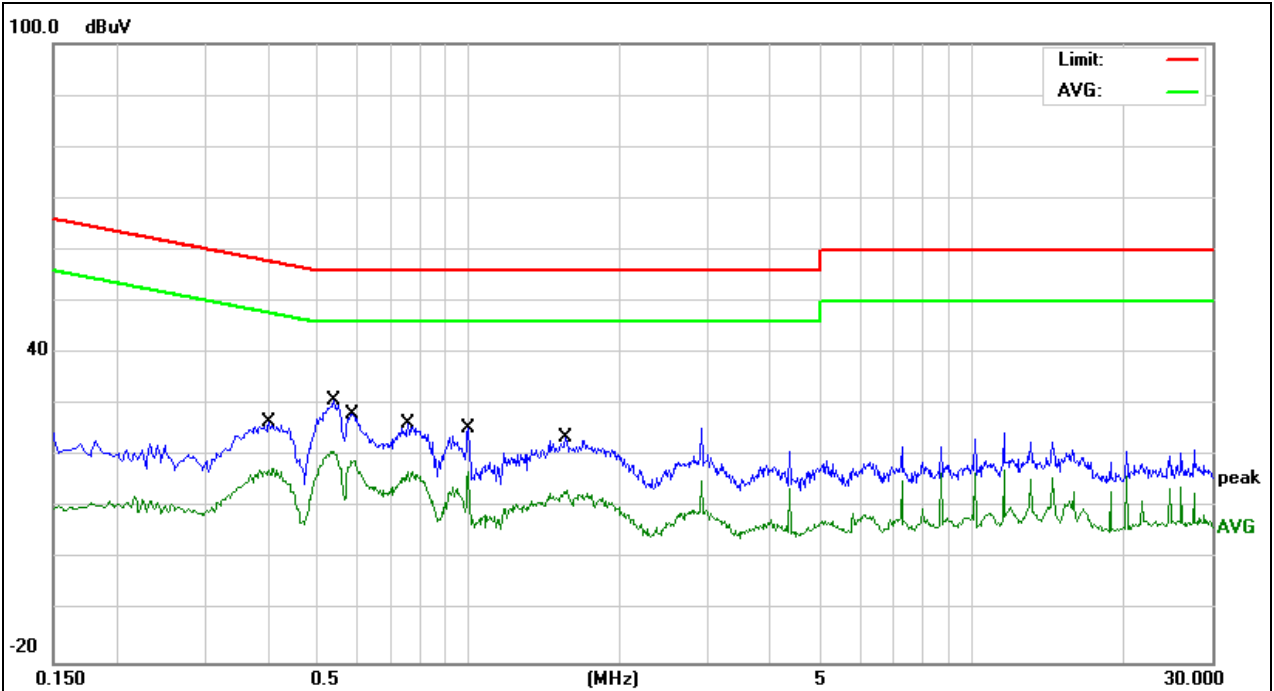

No.	Mk.	Freq.	Reading Level	Correct Factor	Measurement	Limit	Over	Detector	Comment
		MHz	dBuV	dB	dBuV	dBuV	dB		
1		0.4020	16.89	9.74	26.63	57.81	-31.18	QP	
2		0.4020	8.00	9.74	17.74	47.81	-30.07	AVG	
3		0.5420	21.11	9.74	30.85	56.00	-25.15	QP	
4	*	0.5420	11.24	9.74	20.98	46.00	-25.02	AVG	
5		0.5899	18.51	9.74	28.25	56.00	-27.75	QP	
6		0.5899	9.56	9.74	19.30	46.00	-26.70	AVG	
7		0.7620	16.63	9.74	26.37	56.00	-29.63	QP	
8		0.7620	7.27	9.74	17.01	46.00	-28.99	AVG	
9		1.0020	15.78	9.74	25.52	56.00	-30.48	QP	
10		1.0020	7.29	9.74	17.03	46.00	-28.97	AVG	
11		1.5660	14.01	9.77	23.78	56.00	-32.22	QP	
12		1.5660	3.56	9.77	13.33	46.00	-32.67	AVG	

Remark:  
 Correct Factor = Insertion Loss + Cable Loss  
 Measurement Level = Reading Level + Correct Factor  
 Over Level = Measurement Level - Limit

EUT :	LoRa Module	Model Name :	Ra-01
Temperature :	26 °C	Relative Humidity :	54%
Pressure :	1010hPa	Phase :	N
Test Voltage :	DC 3.3V by Control panel and Adapter AC 120V/60Hz	Test Mode :	Mode 1

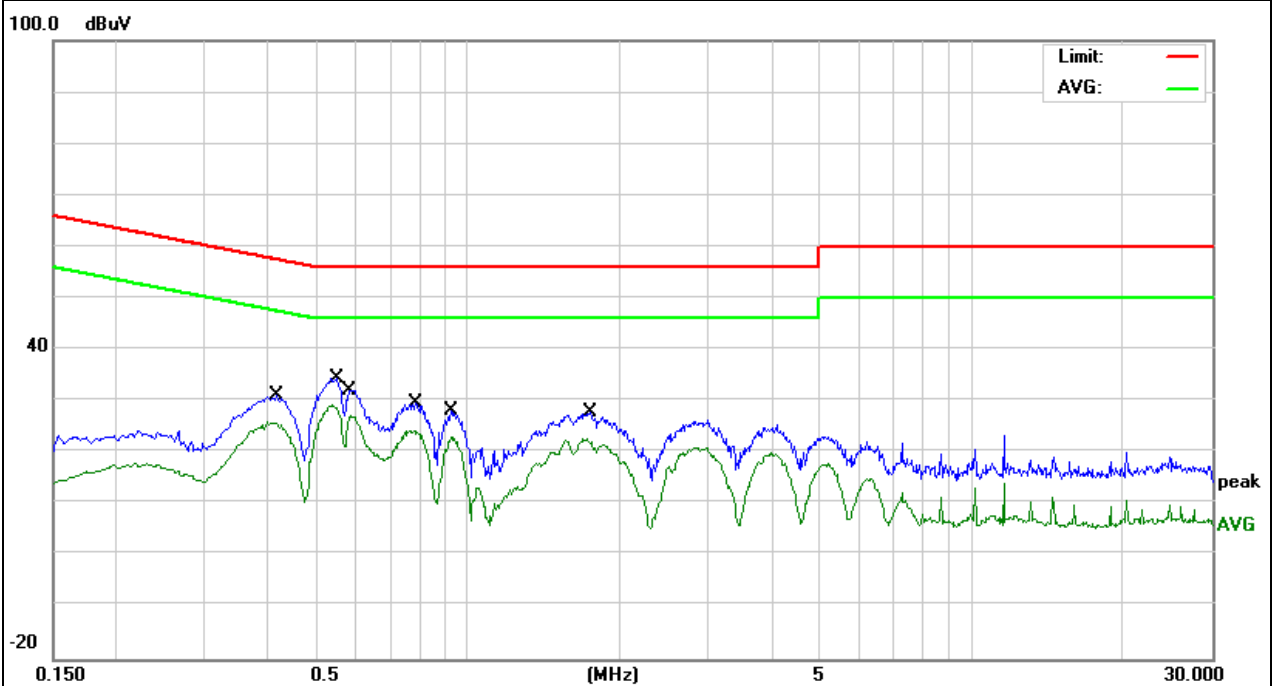

No.	Mk.	Freq. MHz	Reading Level dBuV	Correct Factor dB	Measure- ment dBuV	Limit dBuV	Over dB	Detector	Comment
1		0.4178	21.54	9.75	31.29	57.49	-26.20	QP	
2		0.4178	16.36	9.75	26.11	47.49	-21.38	AVG	
3		0.5500	24.84	9.75	34.59	56.00	-21.41	QP	
4	*	0.5500	19.65	9.75	29.40	46.00	-16.60	AVG	
5		0.5818	22.38	9.75	32.13	56.00	-23.87	QP	
6		0.5818	17.48	9.75	27.23	46.00	-18.77	AVG	
7		0.7860	19.89	9.75	29.64	56.00	-26.36	QP	
8		0.7860	14.64	9.75	24.39	46.00	-21.61	AVG	
9		0.9260	18.32	9.75	28.07	56.00	-27.93	QP	
10		0.9260	13.38	9.75	23.13	46.00	-22.87	AVG	
11		1.7500	17.94	9.78	27.72	56.00	-28.28	QP	
12		1.7500	12.86	9.78	22.64	46.00	-23.36	AVG	

Remark:

Correct Factor = Insertion Loss + Cable Loss

Measurement Level = Reading Level + Correct Factor

Over Level = Measurement Level - Limit



## 9. RADIATED EMISSION MEASUREMENT

### 9.1 Applicable Standard

According to 15.209& 15.205 and ANSI C63.10-2013

### 9.2 Radiated Emission Limits ( FCC 15.209 )

Frequencies (MHz)	Field Strength (microrvolts/meter)	Measurement Distance (meters)
0.009~0.490	2400/F(KHz)	300
0.490~1.705	24000/F(KHz)	30
1.705~30.0	30	30
30~88	100	3
88~216	150	3
216~960	200	3
Above 960	500	3

Note:

- (1) The tighter limit applies at the band edges.
- (2) Emission level (dBuV/m)=20log Emission level (uV/m).
- (3) Measurement was performed at an antenna to the closed point of EUT distance of meters.
- (4) For Frequency 9kHz~30MHz:  
Distance extrapolation factor =40log(Specific distance/ test distance)(dB);  
Limit line=Specific limits(dBuV) + distance extrapolation factor.  
For Frequency above 30MHz:  
Distance extrapolation factor =20log(Specific distance/ test distance)(dB);  
Limit line=Specific limits(dBuV) + distance extrapolation factor.

According to FCC Part 15.205, Restricted bands:

MHz	MHz	MHz	GHz
0.090-0.110	16.42-16.423	399.9-410	4.5-5.15
0.495-0.505	16.69475-16.69525	608-614	5.35-5.46
2.1735-2.1905	16.80425-16.80475	960-1240	7.25-7.75
4.125-4.128	25.5-25.67	1300-1427	8.025-8.5
4.17725-4.17775	37.5-38.25	1435-1626.5	9.0-9.2
4.20725-4.20775	73-74.6	1645.5-1646.5	9.3-9.5
6.215-6.218	74.8-75.2	1660-1710	10.6-12.7
6.26775-6.26825	123-138	2200-2300	14.47-14.5
8.291-8.294	149.9-150.05	2310-2390	15.35-16.2
8.362-8.366	156.52475-156.52525	2483.5-2500	17.7-21.4
8.37625-8.38675	156.7-156.9	2690-2900	22.01-23.12
8.41425-8.41475	162.0125-167.17	3260-3267	23.6-24.0
12.29-12.293	167.72-173.2	3332-3339	31.2-31.8
12.51975-12.52025	240-285	3345.8-3358	36.43-36.5
12.57675-12.57725	322-335.4	3600-4400	(2)
13.36-13.41			

LIMITS OF RADIATED EMISSION MEASUREMENT ( FCC 15.231)

Fundamental Frequency (MHz)	Field Strength of fundamental (microvolts/meter)	Field Strength of Unwanted Emissions (microvolts/meter)
40.66 - 40.70	2250.00	225.00
70 - 130	950.00	95.00
130 - 174	1,250 to 3,750 **	95 to 375 **
174 - 260	3750.00	375.00
260 - 470	3,750 to 9,500 **	375 to 1,250 **
Above 470	9500.00	950.00

Notes:

(1) \*\* linear interpolations

[Where F is the frequency in MHz, the formulas for calculating the maximum permitted fundamental field strengths are as follows: for the band 130-174 MHz, uV/m at 3 meters = 56.81818(F) - 6136.3636; for the band 260-470 MHz, uV/m at 3 meters = 41.6667(F) - 7083.3333. The maximum permitted unwanted emission level is 20 dB below the maximum permitted fundamental level.]

The limits on the field strength of the spurious emissions in the above table are based on the fundamental frequency of the intentional radiator. Spurious emissions shall be attenuated to the average (or, alternatively, CISPR quasi-peak) limits shown in this table or to the general limits shown in 93 Section 15.209, whichever limit permits a higher field strength.

Spectrum Parameter	Setting
Attenuation	Auto
Start Frequency	1000 MHz
Stop Frequency	10th carrier harmonic
RB / VB (emission in restricted band)	1MHz / 1MHz for Peak

Receiver Parameter	Setting
Attenuation	Auto
Start ~ Stop Frequency	9kHz~150kHz / RB 200Hz for QP
Start ~ Stop Frequency	150kHz~30MHz / RB 9kHz for QP
Start ~ Stop Frequency	30MHz~1000MHz / RB 90kHz for QP

### 9.3 TEST PROCEDURE

The test site semi-anechoic chamber has met the requirement of NSA tolerance 4 dB according to the standards: ANSI C63.10-2013. The test distance is 3m. The setup is according to the requirements in Section 13.1.4.1 of ANSI C63.10-2013 and CAN/CSA-CEI/IEC CISPR 22.

This test is required for any spurious emission that falls in a Restricted Band, as defined in Section 15.205. It must be performed with the highest gain of each type of antenna proposed for use with the EUT.

Use the following spectrum analyzer settings:

Spectrum Parameter	Setting
Attenuation	Auto
Start Frequency	1000 MHz
Stop Frequency	10th carrier harmonic
RB / VB (emission in restricted band)	1 MHz / 1 MHz for Peak, 1 MHz / 10Hz for Average

Receiver Parameter	Setting
Attenuation	Auto
Start ~ Stop Frequency	9kHz~150kHz / RB 200Hz for QP
Start ~ Stop Frequency	150kHz~30MHz / RB 9kHz for QP
Start ~ Stop Frequency	30MHz~1000MHz / RB 120kHz for QP

- The measuring distance of at 3 m shall be used for measurements at frequency up to 1GHz. For frequencies above 1GHz, any suitable measuring distance may be used.
- The EUT was placed on the top of a rotating table 0.8 m for below 1GHz and 1.5m for above 1GHz the ground at a 3 meter. The table was rotated 360 degrees to determine the position of the highest radiation.
- The height of the equipment or of the substitution antenna shall be 0.8 m for below 1GHz and 1.5m for above 1GHz; the height of the test antenna shall vary between 1 m to 4 m. Both horizontal and vertical polarizations of the antenna are set to make the measurement.
- For the radiated emission test above 1GHz:  
Place the measurement antenna away from each area of the EUT determined to be a source of emissions at the specified measurement distance, while keeping the measurement antenna aimed at the source of emissions at each frequency of significant emissions, with polarization oriented for maximum response. The measurement antenna may have to be higher or lower than the EUT, depending on the radiation pattern of the emission and staying aimed at the emission source for receiving the maximum signal. The final measurement antenna elevation shall be that which maximizes the emissions. The measurement antenna elevation for maximum emissions shall be restricted to a range of heights of from 1 m to 4 m above the ground or reference ground plane.
- The initial step in collecting conducted emission data is a spectrum analyzer peak detector mode pre-scanning the measurement frequency range. Significant peaks are then marked and then Quasi Peak detector mode re-measured.
- If the Peak Mode measured value compliance with and lower than Quasi Peak Mode Limit, the EUT shall be deemed to meet QP Limits and then no additional QP Mode measurement performed.
- For the actual test configuration, please refer to the related Item –EUT Test Photos.

Note:

Both horizontal and vertical antenna polarities were tested and performed pretest to three orthogonal axis. The worst case emissions were reported

During the radiated emission test, the Spectrum Analyzer was set with the following configurations:

Frequency Band (MHz)	Function	Resolution bandwidth	Video Bandwidth
30 to 1000	QP	120 kHz	300 kHz
Above 1000	Peak	1 MHz	1 MHz
	Average	1 MHz	10 Hz

Note: for the frequency ranges below 30 MHz, a narrower RBW is used for these ranges but the measured value should add a RBW correction factor (RBWCF) where  $RBWCF [dB] = 10 \cdot \lg(100 [kHz] / \text{narrower RBW [kHz]})$ . , the narrower RBW is 1 kHz and RBWCF is 20 dB for the frequency 9 kHz to 150 kHz, and the narrower RBW is 10 kHz and RBWCF is 10 dB for the frequency 150 kHz to 30 MHz.

**9.4 TEST SETUP**

(A) For radiated emissions below 30MHz

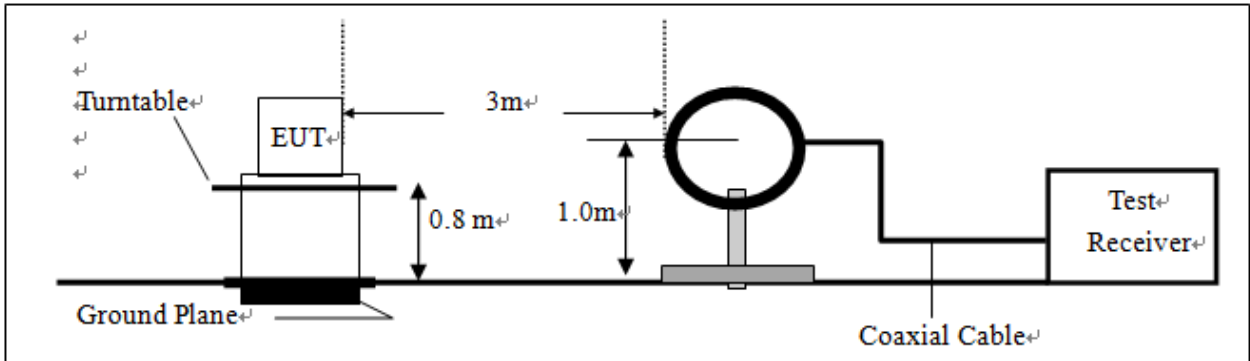

(B) For radiated emissions from 30MHz to 1000MHz

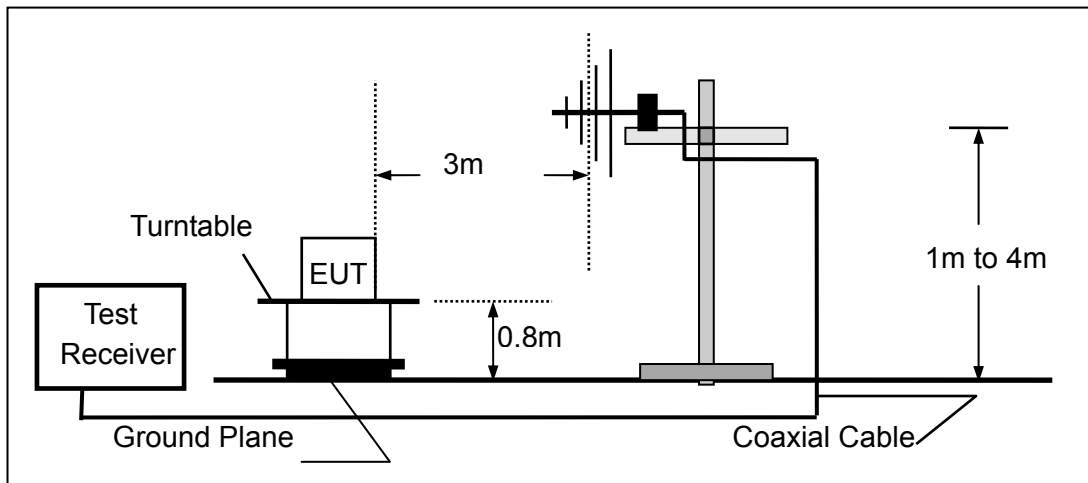

(C) For radiated emissions above 1000MHz

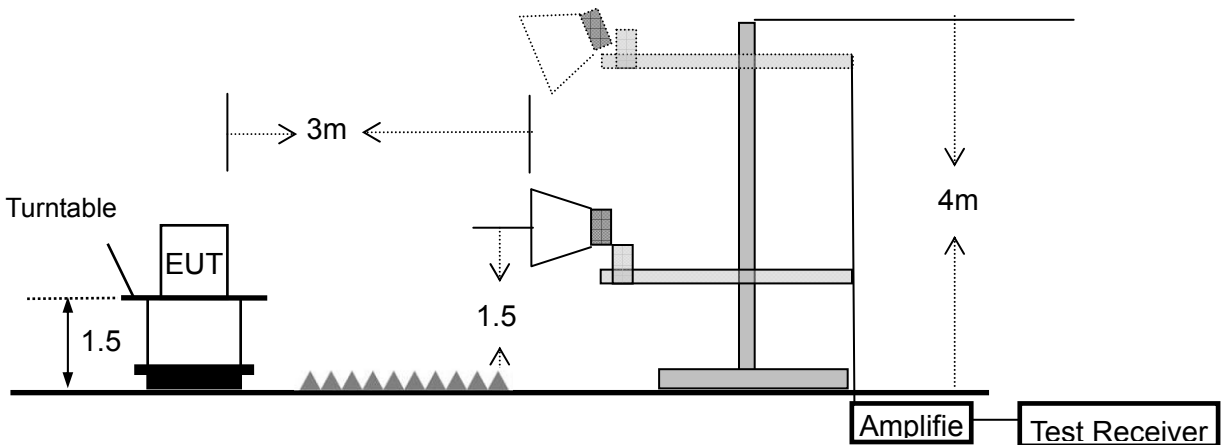

**9.5 TEST RESULTS**

■ Emission below 30MHz (9KHz to 30MHz)

EUT:	LoRa Module	Model Name :	Ra-01
Temperature:	20 °C	Relative Humidity:	48%
Test Mode:	Mode 1	Test By:	Jerry Xie

Freq. (MHz)	Ant.Pol. H/V	Emission Level(dBuV/m)		Limit 3m(dBuV/m)		Over(dB)	
		PK	AV	PK	AV	PK	AV
--	--	--	--	--	--	--	--

Note: the amplitude of spurious emission that is attenuated by more than 20dB below the permissible limit has no need to be reported.

Emission below 1GHz (30MHz to 1GHz)

EUT :	LoRa Module	Model Name :	Ra-01
Temperature :	20 °C	Relative Humidity :	48%
Pressure :	1010hPa	Test Mode :	Mode 1
Test Voltage :	DC 3.3V form Uart		

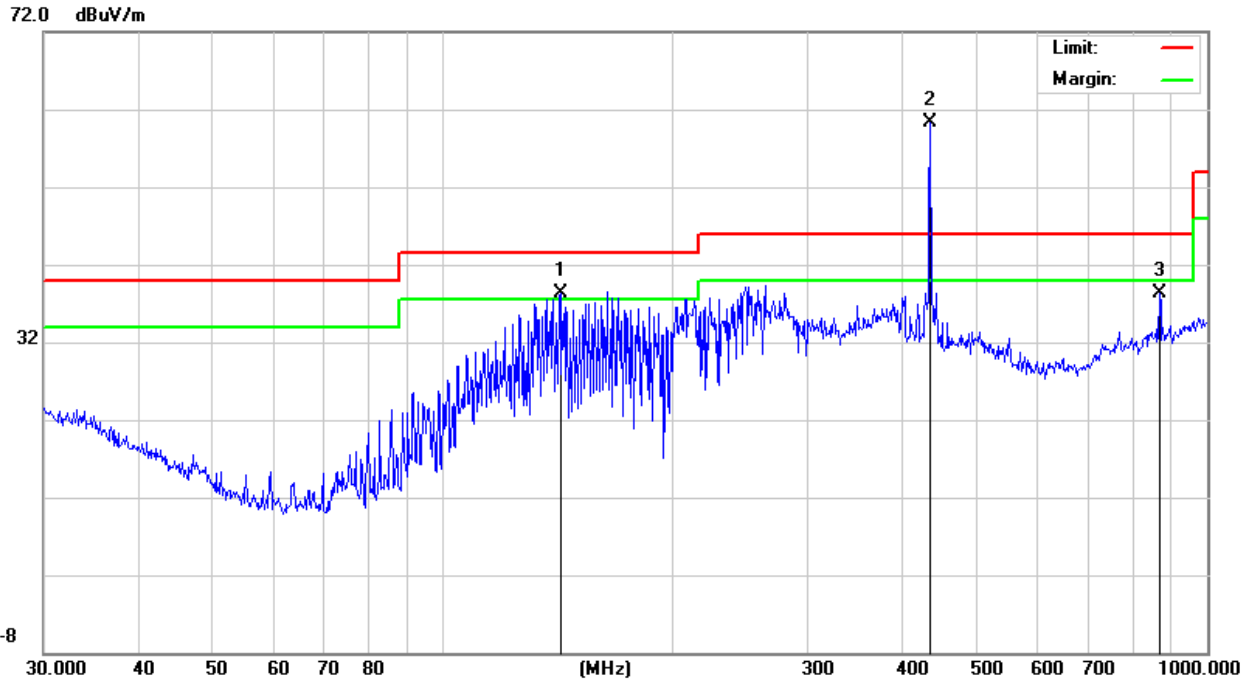

Polar (H/V)	Frequency (MHz)	Reading (dBuV/m)	Correct dB/m	Result (dBuV/m)	Limit (dBuV/m)	Over Limit (dB)	Remark
H	142.3242	26.10	12.24	38.34	43.50	-5.16	QP
H	411	41.97	18.41	60.38	80.04	-19.66	Peak
H	411	-	-	54.53	60.04	-5.51	AVG
H	822	7.09	22.55	29.64	60.04	-30.40	Peak
H	822	-	-	23.79	40.04	-16.25	AVG

Note: The average value of fundamental frequency is:  
 Average= Peak Value+ 20log(Duty cycle), Final Average=Peak -5.777

EUT :	LoRa Module	Model Name :	Ra-01
Temperature :	20 °C	Relative Humidity :	48%
Pressure :	1010hPa	Test Mode :	Mode 1
Test Voltage :	DC 3.3V form Uart		

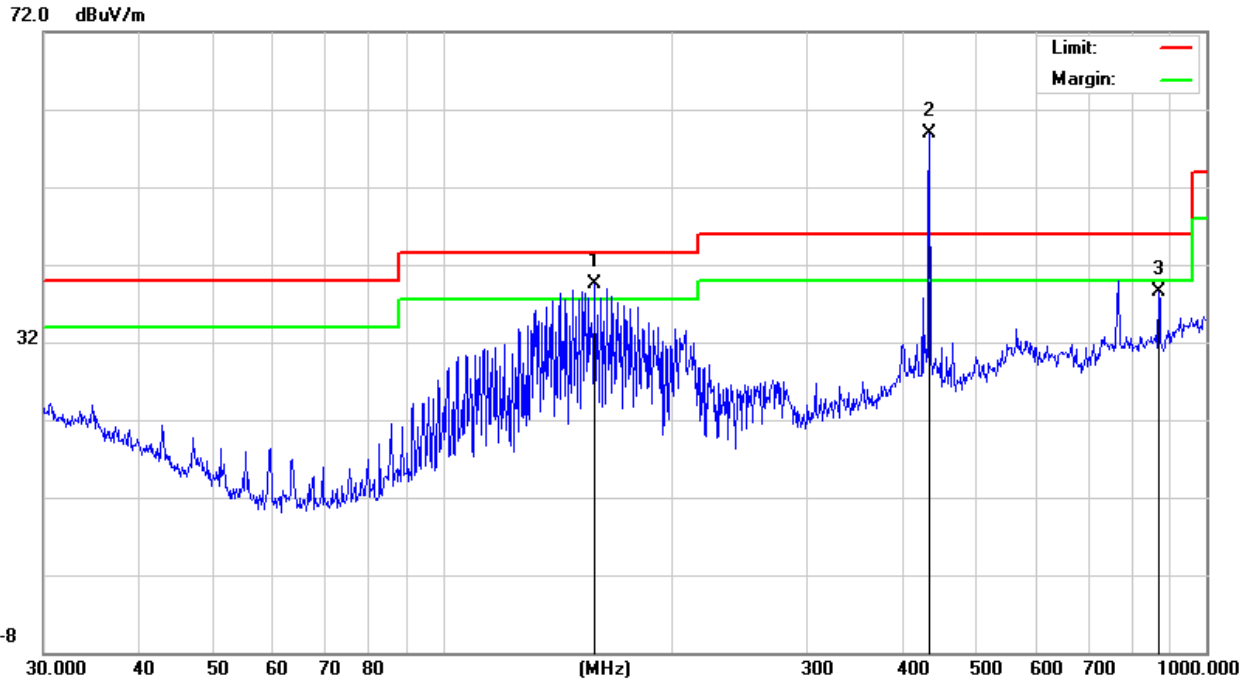

Polar (H/V)	Frequency (MHz)	Reading (dBuV/m)	Correct dB/m	Result (dBuV/m)	Limit (dBuV/m)	Over Limit (dB)	Remark
V	158.11	28.28	11.13	39.41	43.50	-4.09	QP
V	411	40.50	18.41	58.91	80.04	-21.13	Peak
V	411	-	-	53.06	60.04	-6.98	AVG
V	822	12.69	25.91	38.60	60.04	-21.44	Peak
V	822	-	-	32.75	40.04	-7.29	AVG

Note: The average value of fundamental frequency is:

Average= Peak Value+ 20log(Duty cycle), Final Average= Peak-5.777



Emission Above 1GHz (1GHz to 6GHz)

EUT :	LoRa Module	Model Name :	Ra-01
Temperature :	20 °C	Relative Humidity :	48%
Pressure :	1010 hPa	Test Voltage :	DC 3.3V
Test Mode :	Mode 1	Polarization :	Horizontal

No.	Frequency	Reading	Correct Factor	Dutycycle Factor	Result	Limit	Over Limit	Remark
	(MHz)	(dBuV/m)	(dB)	(dB)	(dBuV/m)	(dBuV/m)	(dB)	
1	1233.000	38.77	1.92	-	40.69	60.04	-19.35	Peak
2	1644.000	35.44	2.44	-	37.88	60.04	-22.16	Peak
3	2055.000	38.11	4.01	-	42.12	60.04	-17.92	Peak
4	3847.500	36.76	6.03	-	42.79	74	-31.21	Peak
5	1233.000	-	-	-5.78	34.91	40.04	-5.13	AVG
6	1644.000	-	-	-5.78	32.10	40.04	-7.94	AVG
7	2055.000	-	-	-5.78	36.34	40.04	-3.70	AVG
8	3847.500	-	-	-5.78	37.01	54	-16.99	AVG

EUT :	LoRa Module	Model Name :	Ra-01
Temperature :	20 °C	Relative Humidity :	48%
Pressure :	1010 hPa	Test Voltage :	DC 3.3V
Test Mode :	Mode 1	Polarization :	Vertical

No.	Frequency	Reading	Correct Factor	Dutycycle Factor	Result	Limit	Over Limit	Remark
	(MHz)	(dBuV/m)	(dB)	(dB)	(dBuV/m)	(dBuV/m)	(dB)	
1	1233.000	38.77	1.92	-	40.69	60.04	-19.35	Peak
2	1644.000	39.63	2.44	-	42.07	60.04	-17.97	Peak
3	2055.000	37.77	4.01	-	41.78	60.04	-18.26	Peak
4	2955.000	39.17	6.20	-	45.37	74	-28.63	Peak
5	1233.000	-	-	-5.78	34.91	40.04	-5.13	AVG
6	1644.000	-	-	-5.78	36.29	40.04	-3.75	AVG
7	2055.000	-	-	-5.78	36.00	40.04	-4.04	AVG
8	2095.000	-	-	-5.78	39.59	54	-14.41	AVG

**Note: 1.** EUT Pre-scan X/Y/Z orientation, only worst case is presented in the report(Y orientation).

**2.** \*Calculate Average value based on Duty Cycle correction factor:

$$\text{Duty Cycle} = \text{Ton} / (\text{Ton} + \text{Toff}) = 0.5142 = 51.42\%$$

$$\text{Duty Cycle factor} = 20 \log (\text{Duty Cycle}) = 20 \log (0.5142) = -5.777$$

$$\text{Average} = \text{Peak} + \text{Duty Cycle factor}$$

$$\begin{aligned} \text{2. FCC Limit for Average Measurement} &= 41.6667(411) - 7083.3333 = 10029.18 \mu\text{V/m} \\ &= 80.04 \text{dBuV/m} \end{aligned}$$

**3.** Pulse Desensitization Correction Factor

$$\text{Pulse Width(PW)} = 204.2 \text{ms} \quad 2/\text{PW} = 2/204.2 \text{ms} = 0.00979 \text{kHz}$$

$$\text{RBW}(100 \text{kHz}) > 2/\text{PW} (0.00979 \text{kHz}),$$

Therefore PDCF is not needed.

Duty Cycle:

Channel 01:

The duty cycle is simply the on time divided by the period:

The duration of one cycle = 204.2ms

Effective period of the cycle =105ms,

Duty Cycle =105ms/205.8ms=0.5142=51.42%

■ Emission below 1GHz (30MHz to 1GHz)

EUT :	LoRa Module	Model Name :	Ra-01
Temperature :	20 °C	Relative Humidity :	48%
Pressure :	1010hPa	Test Mode :	Mode 2
Test Voltage :	DC 3.3V form Uart		

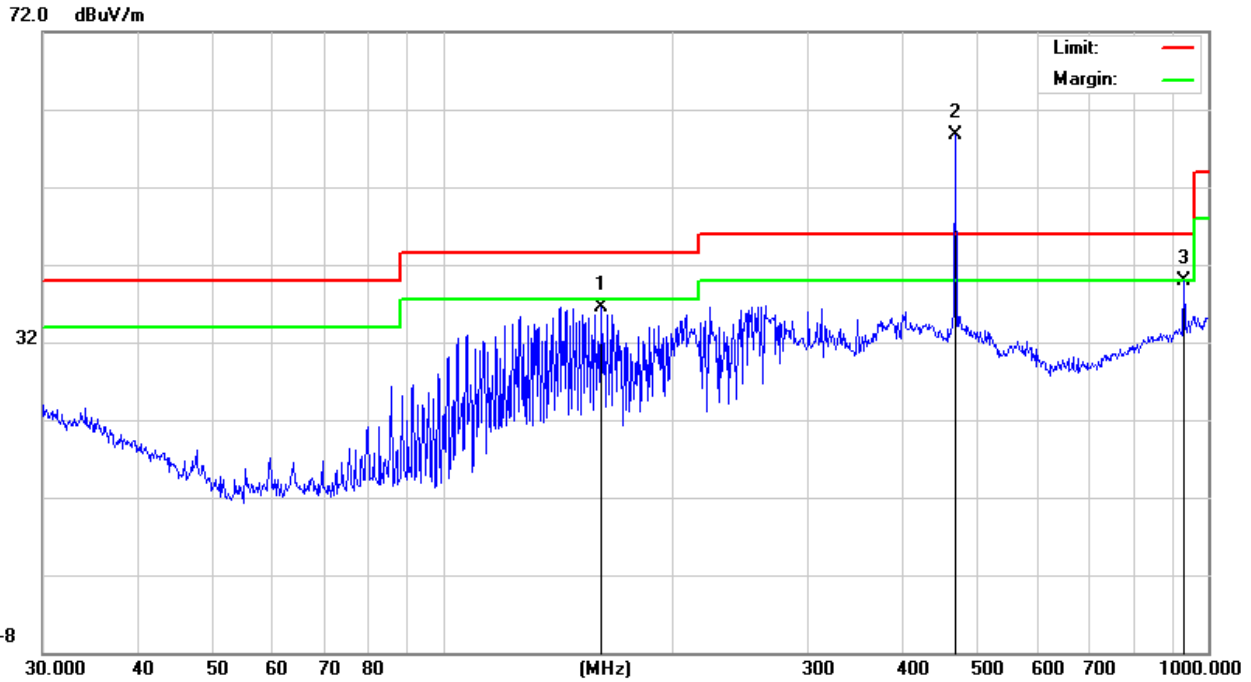

Polar (H/V)	Frequency (MHz)	Reading (dBuV/m)	Correct dB/m	Result (dBuV/m)	Limit (dBuV/m)	Over Limit (dB)	Remark
H	160.9088	25.74	10.75	36.49	43.5	-7.01	QP
H	468	39.52	19.1	58.62	81.88	-23.26	Peak
H	468	-	-	52.74	61.88	-9.138	AVG
H	936	7.09	22.55	29.64	61.88	-32.24	Peak
H	936	-	-	23.762	41.88	-18.118	AVG

Note: The average value of fundamental frequency is:  
 Average= Peak Value+ 20log(Duty cycle), Final Average=Peak -5.878

EUT :	LoRa Module	Model Name :	Ra-01
Temperature :	20 °C	Relative Humidity :	48%
Pressure :	1010hPa	Test Mode :	Mode 2
Test Voltage :	DC 3.3V form Uart		

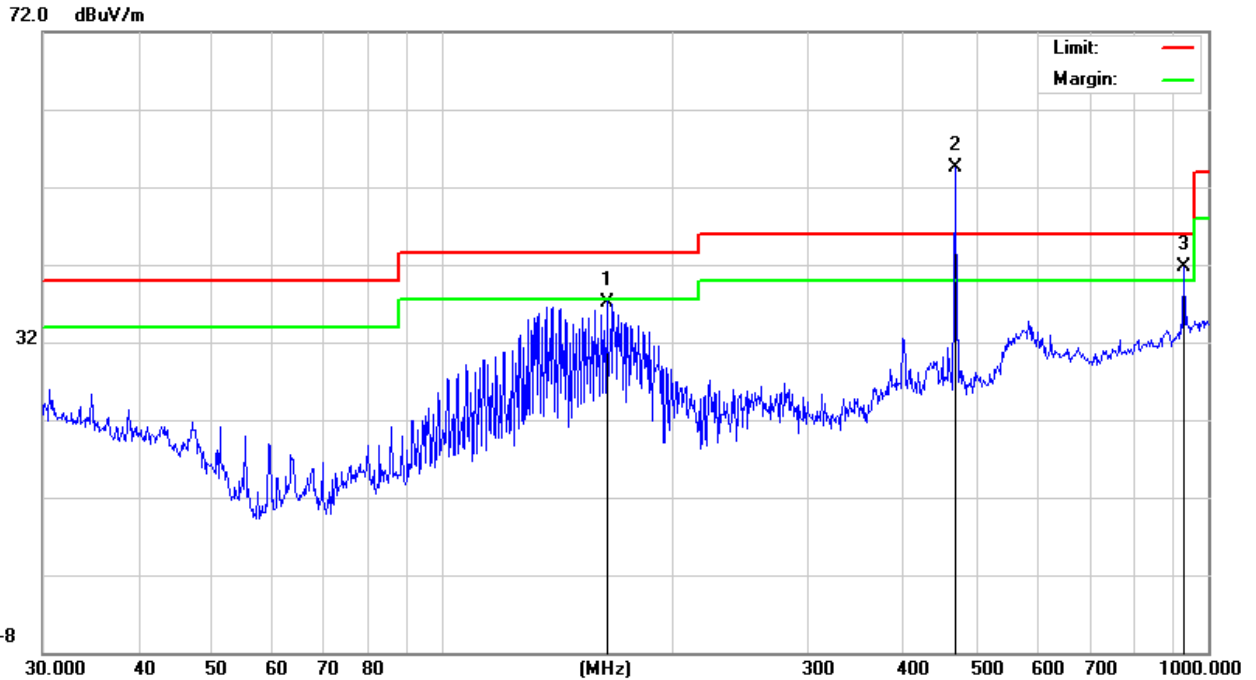

Polar (H/V)	Frequency (MHz)	Reading (dBuV/m)	Correct dB/m	Result (dBuV/m)	Limit (dBuV/m)	Over Limit (dB)	Remark
V	163.7547	26.55	10.65	37.20	43.50	-6.30	QP
V	468	35.34	19.1	54.44	81.88	-27.44	Peak
V	468	-	-	48.562	61.88	-13.318	AVG
V	936	13.92	27.7	41.62	61.88	-20.26	Peak
V	936	-	-	35.742	41.88	-6.138	AVG

Note: The average value of fundamental frequency is:

Average= Peak Value+ 20log(Duty cycle), Final Average= Peak-5.878

Emission Above 1GHz (1GHz to 6GHz)

EUT :	LoRa Module	Model Name :	Ra-01
Temperature :	20 °C	Relative Humidity :	48%
Pressure :	1010 hPa	Test Voltage :	DC 3.3V
Test Mode :	Mode 2	Polarization :	Horizontal

No.	Frequency	Reading	Correct Factor	Dutycycle Factor	Result	Limit	Over Limit	Remark
	(MHz)	(dBuV/m)	(dB)	(dB)	(dBuV/m)	(dBuV/m)	(dB)	
1	1404.000	36.43	1.92	-	38.35	61.88	-23.53	Peak
2	1872.000	34.34	2.44	-	36.78	61.88	-25.10	Peak
3	2340.000	37.77	4.01	-	41.78	61.88	-20.10	Peak
4	3555.350	35.14	6.03	-	41.17	74	-32.83	Peak
5	1233.000	-	-	-5.88	32.47	41.88	-9.41	AVG
6	1644.000	-	-	-5.88	30.90	41.88	-10.98	AVG
7	2055.000	-	-	-5.88	35.90	41.88	-5.98	AVG
8	3555.350	-	-	-5.88	35.29	54	-18.71	AVG

EUT :	LoRa Module	Model Name :	Ra-01
Temperature :	20 °C	Relative Humidity :	48%
Pressure :	1010 hPa	Test Voltage :	DC 3.3V
Test Mode :	Mode 2	Polarization :	Vertical

No.	Frequency	Reading	Correct Factor	Dutycycle Factor	Result	Limit	Over Limit	Remark
	(MHz)	(dBuV/m)	(dB)	(dB)	(dBuV/m)	(dBuV/m)	(dB)	
1	1404.000	37.47	1.92	-	39.39	61.88	-19.35	Peak
2	1872.000	35.51	2.44	-	37.95	61.88	-22.16	Peak
3	2340.000	37.46	4.01	-	41.47	61.88	-17.92	Peak
4	3530.672	36.41	6.03	-	42.44	74	-31.21	Peak
5	1233.000	-	-	-5.88	33.51	41.88	-8.37	AVG
6	1644.000	-	-	-5.88	32.07	41.88	-9.81	AVG
7	2055.000	-	-	-5.88	35.59	41.88	-6.29	AVG
8	3530.672	-	-	-5.88	42.44	54	-11.56	AVG

**Note: 1.** EUT Pre-scan X/Y/Z orientation, only worst case is presented in the report(Y orientation).

**2.** \*Calculate Average value based on Duty Cycle correction factor:

$$\text{Duty Cycle} = \text{Ton} / (\text{Ton} + \text{Toff}) = 0.5083 = 50.83\%$$

$$\text{Duty Cycle factor} = 20 \log (\text{Duty Cycle}) = 20 \log (0.5083) = -5.878$$

$$\text{Average} = \text{Peak} + \text{Duty Cycle factor}$$

$$\begin{aligned} \text{3. FCC Limit for Average Measurement} &= 41.6667(468) - 7083.3333 = 12416.6823 \mu\text{V/m} \\ &= 81.88 \text{dB}\mu\text{V/m} \end{aligned}$$

**3.** Pulse Desensitization Correction Factor

$$\text{Pulse Width(PW)} = 205 \text{ms}$$

$$2/\text{PW} = 2/205 \text{ms} = 0.00976 \text{kHz}$$

$$\text{RBW}(100 \text{kHz}) > 2/\text{PW} (0.00976 \text{kHz}),$$

Therefore PDCF is not needed.

Duty Cycle:

Channel 58:

The duty cycle is simply the on time divided by the period:

$$\text{The duration of one cycle} = 205 \text{ms}$$

$$\text{Effective period of the cycle} = 104.2 \text{ms},$$

$$\text{Duty Cycle} = 104.2 \text{ms} / 205 \text{ms} = 0.5083 = 50.83\%$$

■ Emission below 1GHz (30MHz to 1GHz)

EUT :	LoRa Module	Model Name :	Ra-01
Temperature :	20 °C	Relative Humidity :	48%
Pressure :	1010hPa	Test Mode :	Mode 3
Test Voltage :	DC 3.3V form Uart		

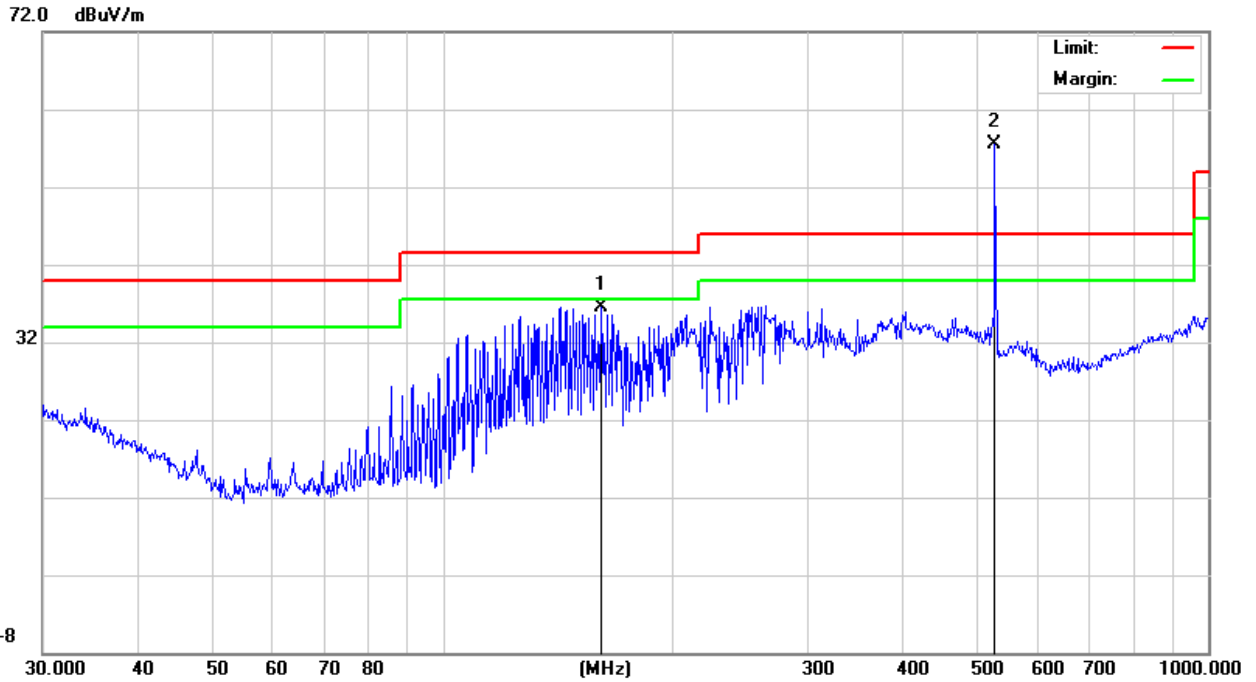

Polar (H/V)	Frequency (MHz)	Reading (dBuV/m)	Correct dB/m	Result (dBuV/m)	Limit (dBuV/m)	Over Limit (dB)	Remark
V	160.9088	25.74	10.75	36.49	43.5	-7.01	QP
V	525	36.81	20.71	57.52	83.4	-25.88	Peak
V	525	-	-	51.808	63.4	-11.592	AVG

Note: The average value of fundamental frequency is:  
 Average= Peak Value+ 20log(Duty cycle), Final Average=Peak -5.712

EUT :	LoRa Module	Model Name :	Ra-01
Temperature :	20 °C	Relative Humidity :	48%
Pressure :	1010hPa	Test Mode :	Mode 3
Test Voltage :	DC 3.3V form Uart		

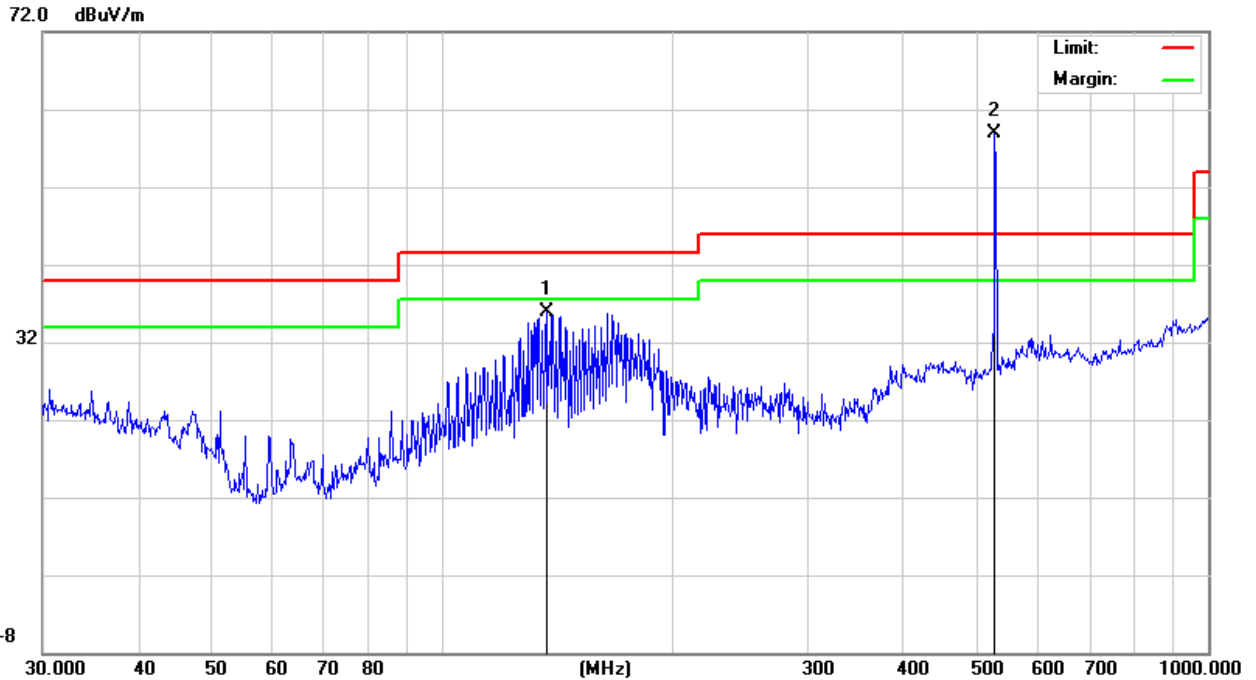

Polar (H/V)	Frequency (MHz)	Reading (dBuV/m)	Correct dB/m	Result (dBuV/m)	Limit (dBuV/m)	Over Limit (dB)	Remark
H	136.4598	23.46	12.47	35.93	43.5	-7.57	QP
H	525	38.2	20.71	58.91	83.4	-24.49	Peak
H	525	-	-	53.198	63.4	-10.202	AVG

Note: The average value of fundamental frequency is:

Average= Peak Value+ 20log(Duty cycle), Final Average= Peak-5.712



■ Emission Above 1GHz (1GHz to 6GHz)

EUT :	LoRa Module	Model Name :	Ra-01
Temperature :	20 °C	Relative Humidity :	48%
Pressure :	1010 hPa	Test Voltage :	DC 3.3V
Test Mode :	Mode 3	Polarization :	Horizontal

No.	Frequency	Reading	Correct Factor	Dutycycle Factor	Result	Limit	Over Limit	Remark
	(MHz)	(dBuV/m)	(dB)	(dB)	(dBuV/m)	(dBuV/m)	(dB)	
1	1050.000	35.45	1.92	-	37.37	63.4	-26.03	Peak
2	1575.000	33.17	2.44	-	35.61	63.4	-27.79	Peak
3	2100.000	33.53	4.01	-	37.54	63.4	-25.86	Peak
4	1233.630	32.82	2.14	-	34.96	74	-39.04	Peak
5	1233.000	-	-	-5.71	31.66	43.4	-11.74	AVG
6	1644.000	-	-	-5.71	29.90	43.4	-13.50	AVG
7	2055.000	-	-	-5.71	31.83	43.4	-11.57	AVG
8	1233.630	-	-	-5.71	29.25	54	-24.75	AVG

EUT :	LoRa Module	Model Name :	Ra-01
Temperature :	20 °C	Relative Humidity :	48%
Pressure :	1010 hPa	Test Voltage :	DC 3.3V
Test Mode :	Mode 3	Polarization :	Vertical

No.	Frequency	Reading	Correct Factor	Dutycycle Factor	Result	Limit	Over Limit	Remark
	(MHz)	(dBuV/m)	(dB)	(dB)	(dBuV/m)	(dBuV/m)	(dB)	
1	1050.000	35.71	1.92	-	37.63	63.4	-25.77	Peak
2	1575.000	33.03	2.44	-	35.47	63.4	-27.93	Peak
3	2100.000	33.19	4.01	-	37.20	63.4	-26.20	Peak
4	1233.630	32.01	2.14	-	34.15	74	-39.85	Peak
5	1233.000	-	-	-5.71	31.92	43.4	-11.48	AVG
6	1644.000	-	-	-5.71	29.76	43.4	-13.64	AVG
7	2055.000	-	-	-5.71	31.49	43.4	-11.91	AVG
8	1233.630	-	-	-5.71	28.44	54	-25.56	AVG

**Note: 1.** EUT Pre-scan X/Y/Z orientation, only worst case is presented in the report(Y orientation).

**2.** \*Calculate Average value based on Duty Cycle correction factor:

$$\text{Duty Cycle} = \text{Ton} / (\text{Ton} + \text{Toff}) = 0.5181 = 51.811\%$$

$$\text{Duty Cycle factor} = 20 \log (\text{Duty Cycle}) = 20 \log (0.5181) = -5.712$$

$$\text{Average} = \text{Peak} + \text{Duty Cycle factor}$$

$$\begin{aligned} 2. \text{ FCC Limit for Average Measurement} &= 41.6667(525) - 7083.3333 = 14791.68 \mu\text{V/m} \\ &= 83.40 \text{dBuV/m} \end{aligned}$$

**3.** Pulse Desensitization Correction Factor

$$\text{Pulse Width (PW)} = 204.2 \text{ms} \quad 2/\text{PW} = 2/204.2 \text{ms} = 0.00979 \text{kHz}$$

$$\text{RBW (100kHz)} > 2/\text{PW} (0.00979 \text{kHz}),$$

Therefore PDCF is not needed.

Duty Cycle:

Channel 115:

The duty cycle is simply the on time divided by the period:

$$\text{The duration of one cycle} = 204.2 \text{ms}$$

$$\text{Effective period of the cycle} = 105.8 \text{ms},$$

$$\text{Duty Cycle} = 105.8 \text{ms} / 204.2 \text{ms} = 0.5181 = 51.81\%$$

### Channel 01

(Duty cycle)  $T_{ON}$ (one hop)

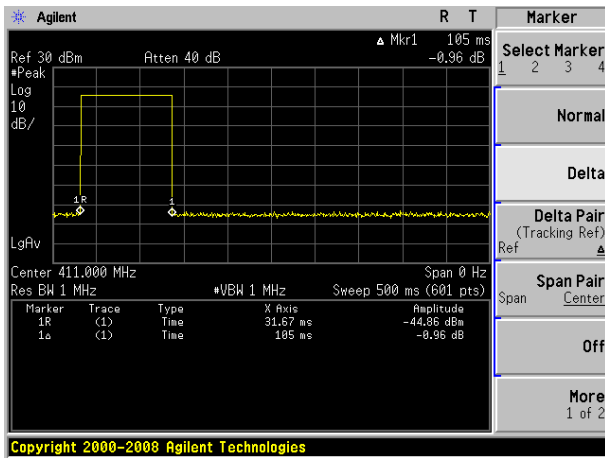

(Duty cycle) The duration of one cycle

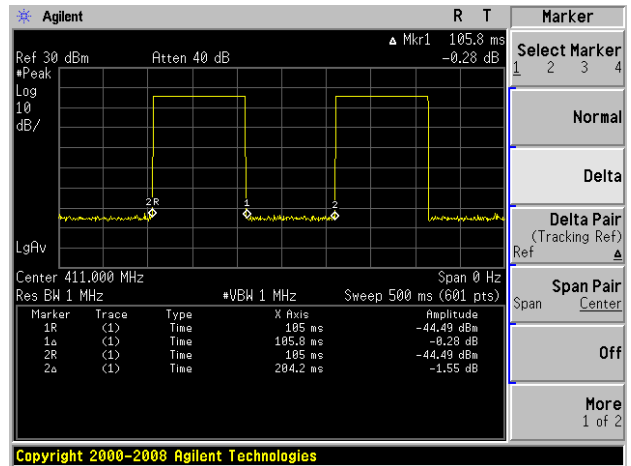

### Channel 58

(Duty cycle)  $T_{ON}$ (one hop)

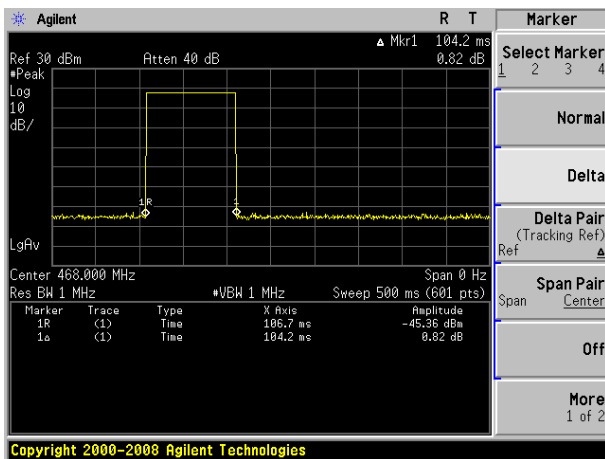

(Duty cycle) The duration of one cycle

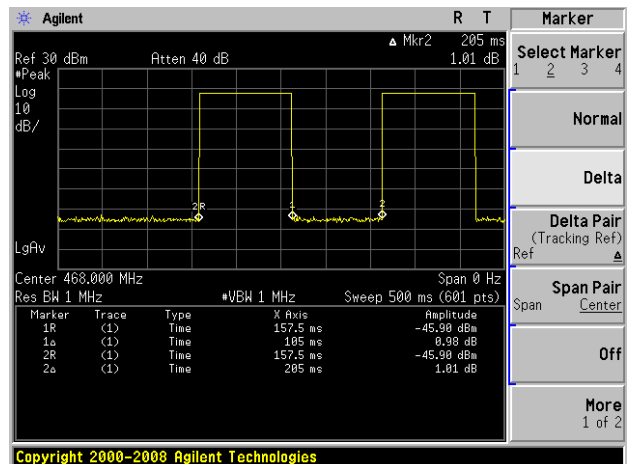

### Channel 115

(Duty cycle)  $T_{ON}$ (one hop)

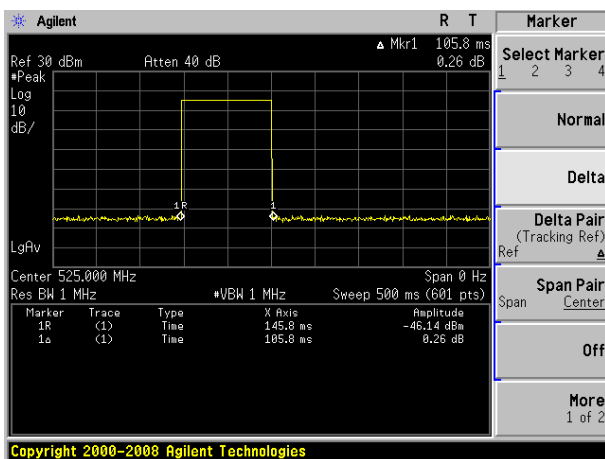

(Duty cycle) The duration of one cycle

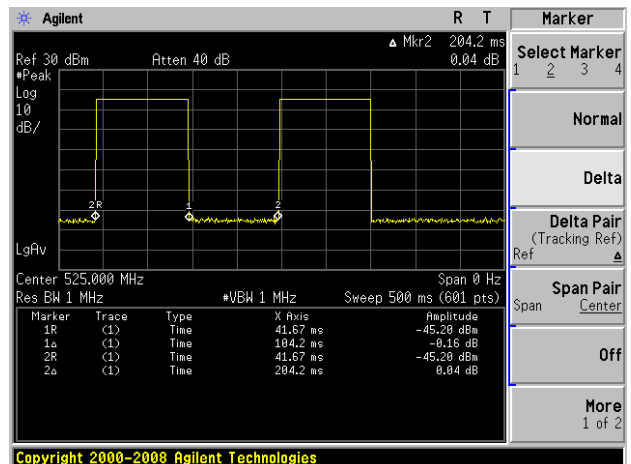

## 10. BANDWIDTH TEST

### 10.1 TEST PROCEDURE

The bandwidth of the emission shall be no wider than 0.25% of the center frequency for devices operating above 70 MHz and below 900 MHz. For devices operating above 900 MHz, the emission shall be no wider than 0.5% of the center frequency. Bandwidth is determined at the points 20 dB down from the modulated carrier.

Limit:  $411\text{MHz} \times 0.25\% = 1027.5\text{KHz}$

$468\text{MHz} \times 0.25\% = 1170\text{KHz}$

$525\text{MHz} \times 0.25\% = 1312.5\text{KHz}$

### 10.2 DEVIATION FROM STANDARD

No deviation.

### 10.3 TEST SETUP

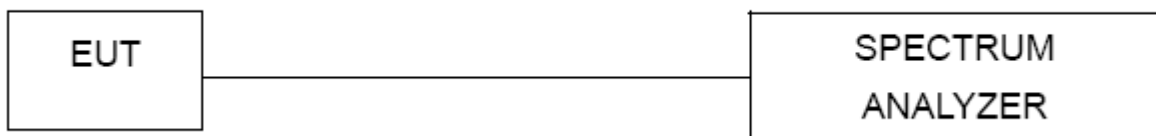

**10.4 TEST RESULTS**

EUT :	LoRa Module	Model Name :	Ra-01
Temperature :	26 °C	Relative Humidity :	53%
Pressure :	1020 hPa	Test Power :	DC 3.3V form Uart
Test Mode :	TX CH 01/58/115		

Test Channel	Frequency (MHz)	20 dB Bandwidth (kHz)	<Limit (kHz)
CH01	411	141.087	1027.5
CH58	468	139.716	1170
CH115	525	139.367	1312.5

CH 01

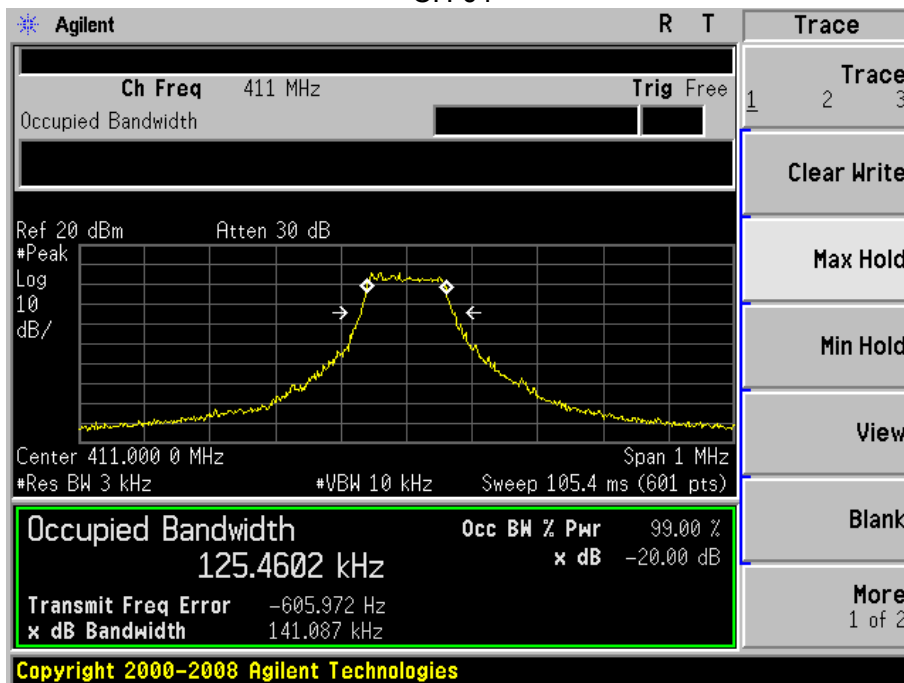

CH 58

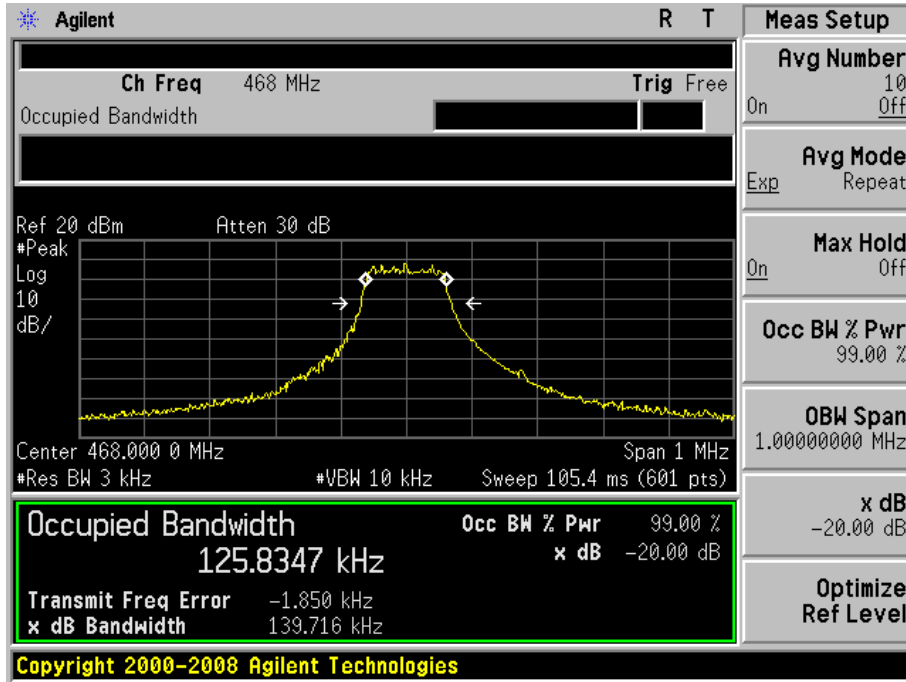

CH 115

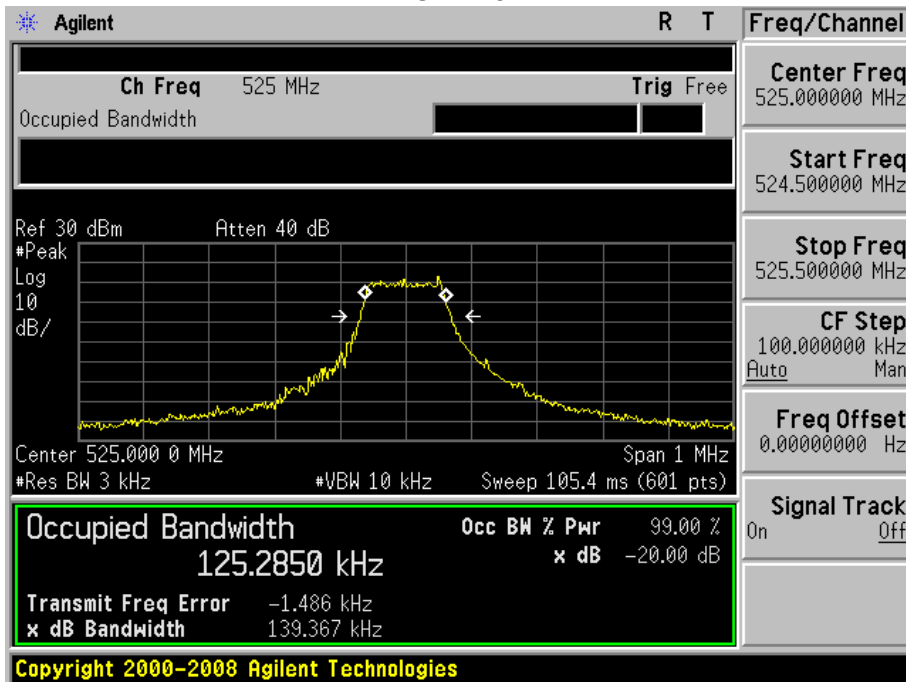

**11. TRANSMITTER TIMEOUT**

**11.1 REQUIREMENTS**

1	A manually operated transmitter shall employ a switch that will automatically deactivate the transmitter within not more than 5 seconds of being released. <b>Result:</b> The EUT is a manually activated transmitter, press 5 seconds will automatically stop working
2	A transmitter activated automatically shall cease transmission within 5 seconds after activation. <b>Result:</b> The EUT is a manually activated transmitter, press 5 seconds will automatically stop working
3	Periodic transmissions at regular predetermined intervals are not permitted. However, polling or supervision transmissions, including data, to determine system integrity of transmitters used in security or safety applications are allowed if the total duration of transmissions does not exceed more than two seconds per hour for each transmitter. There is no limit on the number of individual transmissions, provided the total transmission time does not exceed two seconds per hour <b>Result:</b> The EUT does not support periodic transmission at regular predetermined intervals.
4	Intentional radiators which are employed for radio control purposes during emergencies involving fire, security, and safety of life, when activated to signal an alarm, may operate during the pendency of the alarm condition. <b>Result:</b> The section is not applicable to EUT.

Test data  
CH 01

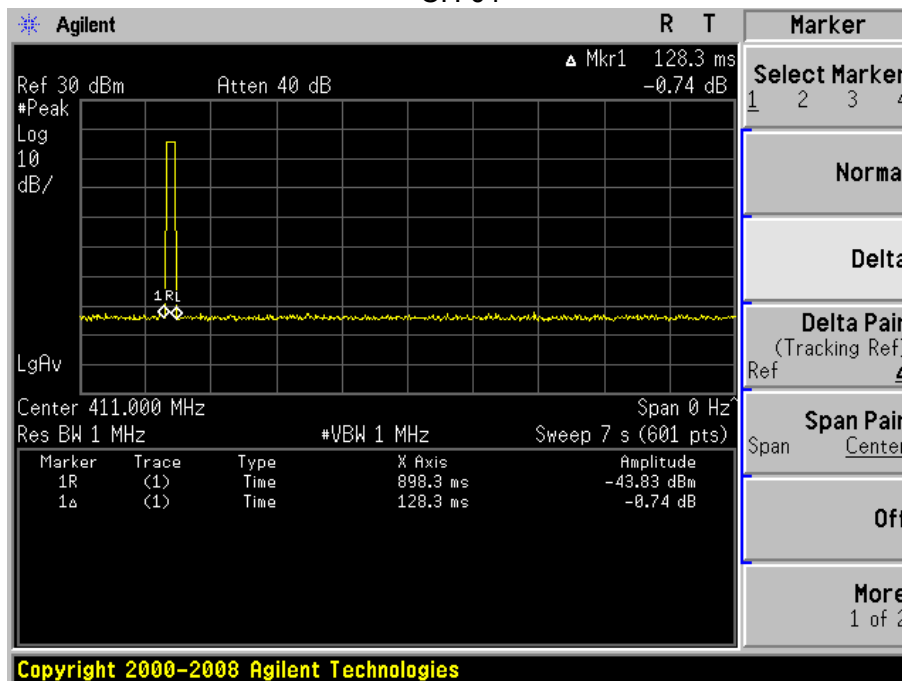

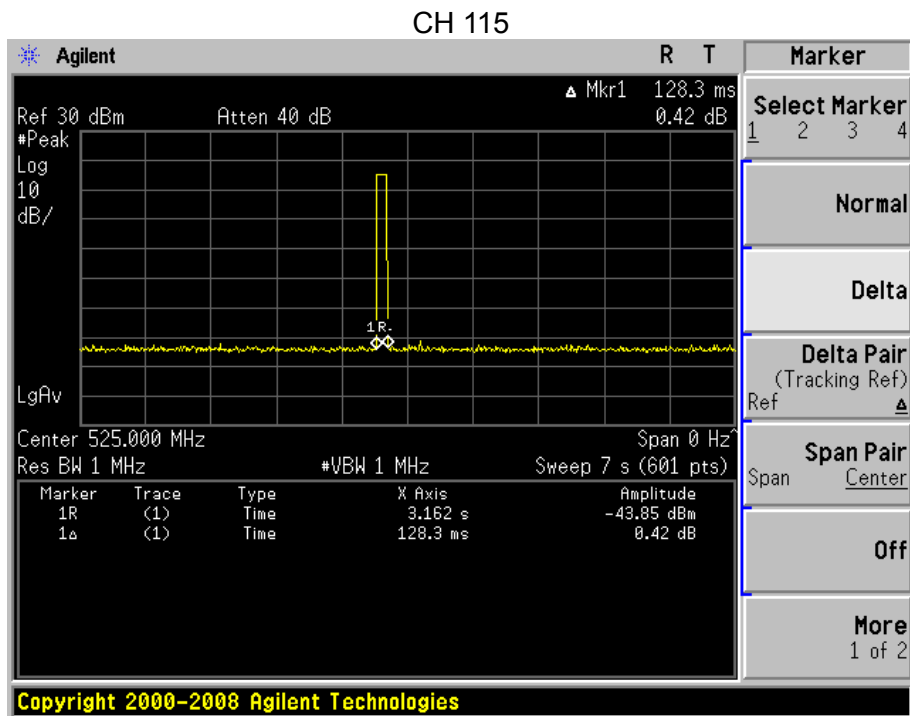
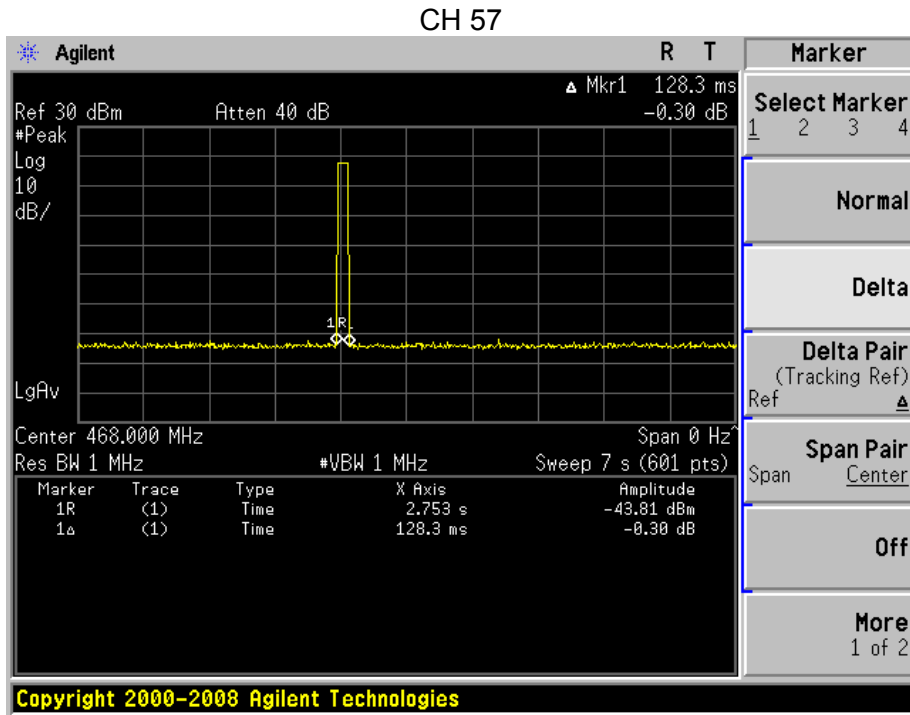

CHANNEL	THE DURATION OF EACH TRANSMISSION	LIMIT	RESULT
CH 01	0.1283s	<5s	PASS
CH 58	0.1283s	<5s	PASS
CH 115	0.1283s	<5s	PASS

END OF REPORT