

APPLICATION CERTIFICATION FCC Part 15C
On Behalf of
Head-Direct (Kunshan) Co., LTD

Bluemini Bluetooth Dongle
Model No.: Bluemini

FCC ID: 2ATP3-BLUEMINI

Prepared for : Head-Direct (Kunshan) Co., LTD
Address : No.2001, Yingbin West Road, Bacheng Town, Kunshan City,
Jiangsu Province, China

Prepared by : Shenzhen Accurate Technology Co., Ltd.
Address : 1/F., Building A, Changyuan New Material Port, Science &
Industry Park, Nanshan District, Shenzhen, Guangdong, P.R.
China

Tel: (0755) 26503290

Fax: (0755) 26503396

Report No. : ATE20200222
Date of Test : March 20-26, 2020
Date of Report : March 26, 2020

TABLE OF CONTENTS

Description	Page
Test Report Certification	
1. GENERAL INFORMATION	5
1.1. Description of Device (EUT).....	5
1.2. Carrier Frequency of Channels.....	5
1.3. Special Accessory and Auxiliary Equipment	6
1.4. Description of Test Facility	6
1.5. Measurement Uncertainty.....	6
2. MEASURING DEVICE AND TEST EQUIPMENT	7
3. OPERATION OF EUT DURING TESTING	8
3.1. Operating Mode.....	8
3.2. Configuration and peripherals	8
4. TEST PROCEDURES AND RESULTS	9
5. 6DB BANDWIDTH TEST.....	10
5.1. Block Diagram of Test Setup.....	10
5.2. The Requirement For Section 15.247(a)(2).....	10
5.3. EUT Configuration on Test	10
5.4. Operating Condition of EUT	10
5.5. Test Procedure	10
5.6. Test Result	11
6. MAXIMUM PEAK OUTPUT POWER TEST	13
6.1. Block Diagram of Test Setup.....	13
6.2. The Requirement For Section 15.247(b)(3).....	13
6.3. EUT Configuration on Test	13
6.4. Operating Condition of EUT	13
6.5. Test Procedure	13
6.6. Test Result	14
7. POWER SPECTRAL DENSITY TEST.....	16
7.1. Block Diagram of Test Setup.....	16
7.2. The Requirement For Section 15.247(e).....	16
7.3. EUT Configuration on Test	16
7.4. Operating Condition of EUT	16
7.5. Test Procedure	17
7.6. Test Result	17
8. BAND EDGE COMPLIANCE TEST	20
8.1. Block Diagram of Test Setup.....	20
8.2. The Requirement For Section 15.247(d)	20
8.3. EUT Configuration on Test	20
8.4. Operating Condition of EUT	20
8.5. Test Procedure	21
8.6. Test Result	21
9. RADIATED SPURIOUS EMISSION TEST	27
9.1. Block Diagram of Test Setup.....	27
9.2. The Limit For Section 15.247(d)	28
9.3. Restricted bands of operation	29
9.4. Configuration of EUT on Test.....	29

9.5.	Operating Condition of EUT	30
9.6.	Test Procedure	30
9.7.	Data Sample.....	31
9.8.	Test Result	31
10.	POWER LINE CONDUCTED EMISSION TEST	44
10.1.	Block Diagram of Test Setup.....	44
10.2.	Test System Setup.....	44
10.3.	Test Limits	45
10.4.	Configuration of EUT on Test.....	45
10.5.	Operating Condition of EUT	45
10.6.	Test Procedure	45
10.7.	Data Sample.....	46
10.8.	Test Result	46
11.	ANTENNA REQUIREMENT.....	49
11.1.	The Requirement	49
11.2.	Antenna Construction	49

Test Report Certification

Applicant : Head-Direct (Kunshan) Co., LTD
Manufacturer : Head-Direct (Kunshan) Co., LTD
EUT Description : Bluemini Bluetooth Dongle
Model No. : Bluemini

Measurement Procedure Used:

**FCC Rules and Regulations Part 15 Subpart C Section 15.247
ANSI C63.10: 2013**

The EUT was tested according to DTS test procedure of August 24, 2018 KDB558074 D01 DTS Meas Guidance v05 for compliance to FCC 47CFR 15.247 requirements

The device described above is tested by Shenzhen Accurate Technology Co., Ltd. to determine the maximum emission levels emanating from the device. The maximum emission levels are compared to the FCC Part 15 Subpart C Section 15.247 limits. The measurement results are contained in this test report and Shenzhen Accurate Technology Co., Ltd. is assumed full responsibility for the accuracy and completeness of these measurements. Also, this report shows that the Equipment Under Test (EUT) is to be technically compliant with the FCC requirements.

This report applies to above tested sample only. This report shall not be reproduced in part without written approval of Shenzhen Accurate Technology Co., Ltd.

Date of Test : March 20-26, 2020
Date of Report : March 26, 2020

Prepared by :

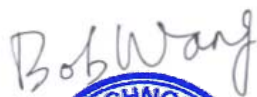
(Bob Wang, Engineer)

Approved & Authorized Signer :

(Sean Liu, Manager)

1. GENERAL INFORMATION

1.1. Description of Device (EUT)

Model Number : Bluemini
Bluetooth version : V4.2
Frequency Range : 2402MHz-2480MHz
Number of Channels : 40
Antenna Gain(Max) : 3dBi
Antenna type : Integral Antenna
Modulation mode : GFSK
Power supply : DC 3.7V (Powered by Lithium battery) or
DC 5.0V (Powered by USB port)
Trade Mark : HIFIMAN
Applicant : Head-Direct (Kunshan) Co., LTD
Address : No.2001, Yingbin West Road, Bacheng Town, Kunshan
City, Jiangsu Province, China
Manufacturer : Head-Direct (Kunshan) Co., LTD
Address : No.2001, Yingbin West Road, Bacheng Town, Kunshan
City, Jiangsu Province, China

1.2. Carrier Frequency of Channels

Channel	Frequency (MHz)	Channel	Frequency (MHz)	Channel	Frequency (MHz)	Channel	Frequency (MHz)
0	2402	10	2422	20	2442	30	2462
1	2404	11	2424	21	2444	31	2464
2	2406	12	2426	22	2446	32	2466
3	2408	13	2428	23	2448	33	2468
4	2410	14	2430	24	2450	34	2470
5	2412	15	2432	25	2452	35	2472
6	2414	16	2434	26	2454	36	2474
7	2416	17	2436	27	2456	37	2476
8	2418	18	2438	28	2458	38	2478
9	2420	19	2440	29	2460	39	2480

1.3.Special Accessory and Auxiliary Equipment

AC/DC Power Adapter: (provided by laboratory)	:	Model:BEK-QC-001 INPUT: 120V~60Hz OUTPUT:5V/1A
--	---	--

1.4.Description of Test Facility

- EMC Lab : Recognition of accreditation by Federal Communications Commission (FCC)
The Designation Number is CN1189
The Registration Number is 708358
- Listed by Innovation, Science and Economic Development Canada (ISED)
The Registration Number is 5077A-2
- Accredited by China National Accreditation Service for Conformity Assessment (CNAS)
The Registration Number is CNAS L3193
- Accredited by American Association for Laboratory Accreditation (A2LA)
The Certificate Number is 4297.01
- Name of Firm : Shenzhen Accurate Technology Co., Ltd.
- Site Location : 1/F., Building A, Changyuan New Material Port, Science & Industry Park, Nanshan District, Shenzhen, Guangdong, P.R. China

1.5.Measurement Uncertainty

- Radiated emission expanded uncertainty (9kHz-30MHz) : U=2.66dB, k=2
- Radiated emission expanded uncertainty (30MHz-1000MHz) : U=4.28dB, k=2
- Radiated emission expanded uncertainty (1G-18GHz) : U=4.98dB, k=2
- Radiated emission expanded uncertainty (18G-26.5GHz) : U=5.06dB, k=2
- Conduction Emission Expanded Uncertainty (Mains ports, 9kHz-30MHz) : U=2.72dB, k=2
- Conduction Emission Expanded Uncertainty (Telecommunication ports, 150kHz-30MHz) : U=2.94dB, k=2
- Power disturbance Expanded Uncertainty : U=2.92dB, k=2
- Harmonic current expanded uncertainty : U=0.512%, k=2

2. MEASURING DEVICE AND TEST EQUIPMENT

Table 1: List of Test and Measurement Equipment

Kind of equipment	Manufacturer	Type	S/N	Calibrated dates	Cal. Interval
EMI Test Receiver	Rohde&Schwarz	ESCS30	100307	Jan. 04, 2020	One Year
EMI Test Receiver	Rohde&Schwarz	ESR	101817	Jan. 04, 2020	One Year
Spectrum Analyzer	Rohde&Schwarz	FSV-40	101495	Jan. 04, 2020	One Year
Pre-Amplifier	Rohde&Schwarz	CBLU118354 0-01	3791	Jan. 04, 2020	One Year
Loop Antenna	Schwarzbeck	FMZB1516	1516131	Jan. 04, 2020	One Year
Bilog Antenna	Schwarzbeck	VULB9163	9163-323	Jan. 04, 2020	One Year
Horn Antenna	Schwarzbeck	BBHA9120D	9120D-655	Jan. 04, 2020	One Year
Horn Antenna	Schwarzbeck	BBHA9170	9170-359	Jan. 04, 2020	One Year
LISN	Schwarzbeck	NSLK8126	8126431	Jan. 04, 2020	One Year
Highpass Filter	Wainwright Instruments	WHKX3.6/18 G-10SS	N/A	Jan. 04, 2020	One Year
Band Reject Filter	Wainwright Instruments	WRCG2400/2 485-2375/2510 -60/11SS	N/A	Jan. 04, 2020	One Year
RF Coaxial Cable (Conducted Emission)	SUHNER	N-2m	No.2	Jan. 04, 2020	One Year
RF Coaxial Cable (Radiated Emission)	RESENBERGER	N-12m	No.11	Jan. 04, 2020	One Year
RF Coaxial Cable (Radiated Emission)	RESENBERGER	N-0.5m	No.12	Jan. 04, 2020	One Year
RF Coaxial Cable (Radiated Emission)	SUHNER	N-2m	No.13	Jan. 04, 2020	One Year
RF Coaxial Cable (Radiated Emission)	SUHNER	N-0.5m	No.15	Jan. 04, 2020	One Year
RF Coaxial Cable (Radiated Emission)	SUHNER	N-2m	No.16	Jan. 04, 2020	One Year
RF Coaxial Cable (Radiated Emission)	RESENBERGER	N-6m	No.17	Jan. 04, 2020	One Year
Conducted Emission Measurement Software: ES-K1 V1.71					
Radiated Emission Measurement Software: EZ_EMV V1.1.4.2					

3. OPERATION OF EUT DURING TESTING

3.1. Operating Mode

The mode is used: **Transmitting mode**

Low Channel: 2402MHz

Middle Channel: 2440MHz

High Channel: 2480MHz

Note: The equipment under test (EUT) was tested under new battery.

The Bluetooth has been tested under continuous transmission mode.

Its duty cycle setting is greater than 98%.

3.2. Configuration and peripherals

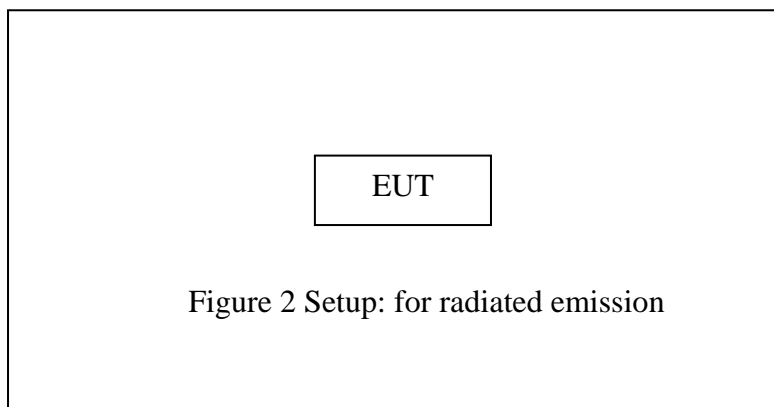
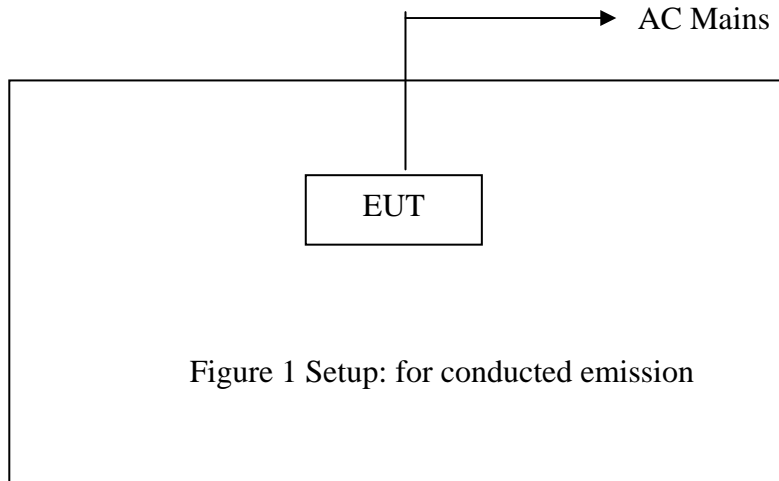

4. TEST PROCEDURES AND RESULTS

FCC Rules	Description of Test	Result
Section 15.247(a)(2)	6dB Bandwidth Test	Compliant
Section 15.247(b)(3)	Maximum Peak Output Power Test	Compliant
Section 15.247(e)	Power Spectral Density Test	Compliant
Section 15.247(d)	Band Edge Compliance Test	Compliant
Section 15.247(d) Section 15.209	Radiated Spurious Emission Test	Compliant
Section 15.207	AC Power Line Conducted Emission Test	Compliant
Section 15.203	Antenna Requirement	Compliant

5. 6DB BANDWIDTH TEST

5.1. Block Diagram of Test Setup

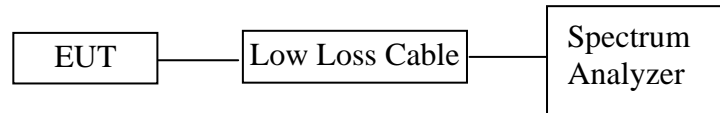

5.2. The Requirement For Section 15.247(a)(2)

Section 15.247(a)(2): Systems using digital modulation techniques may operate in the 902-928MHz, 2400-2483.5MHz, and 5725-5850MHz bands. The minimum 6 dB bandwidth shall be at least 500 kHz.

5.3. EUT Configuration on Test

The equipment is installed on the emission measurement to meet the commission requirements and operating regulations in a manner which tends to maximize its emission characteristics in normal application.

5.4. Operating Condition of EUT

5.4.1. Setup the EUT and simulator as shown as Section 5.1.

5.4.2. Turn on the power of all equipment.

5.4.3. Let the EUT work in TX modes measure it. The transmit frequency are 2402-2480MHz. We select 2402MHz, 2440MHz, and 2480MHz TX frequency to transmit.

5.5. Test Procedure

5.5.1. The transmitter output was connected to the spectrum analyzer through a low loss cable.

5.5.2. Set RBW of spectrum analyzer to 100 kHz and VBW to 300 kHz.

5.5.3. The 6dB bandwidth is defined as the total spectrum the power of which is higher than peak power minus 6dB.

5.6. Test Result

Channel	Frequency (MHz)	6 dB Bandwidth (MHz)	Minimum Limit(MHz)	Result
0	2402	0.708	0.5	Pass
19	2440	0.708	0.5	Pass
39	2480	0.702	0.5	Pass

The spectrum analyzer plots are attached as below.

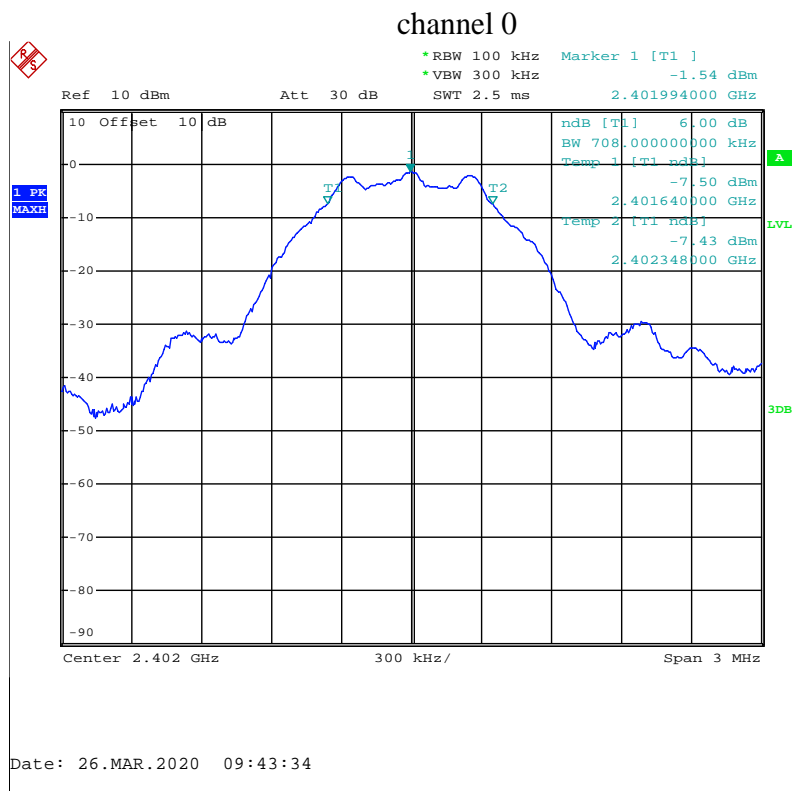

channel 19

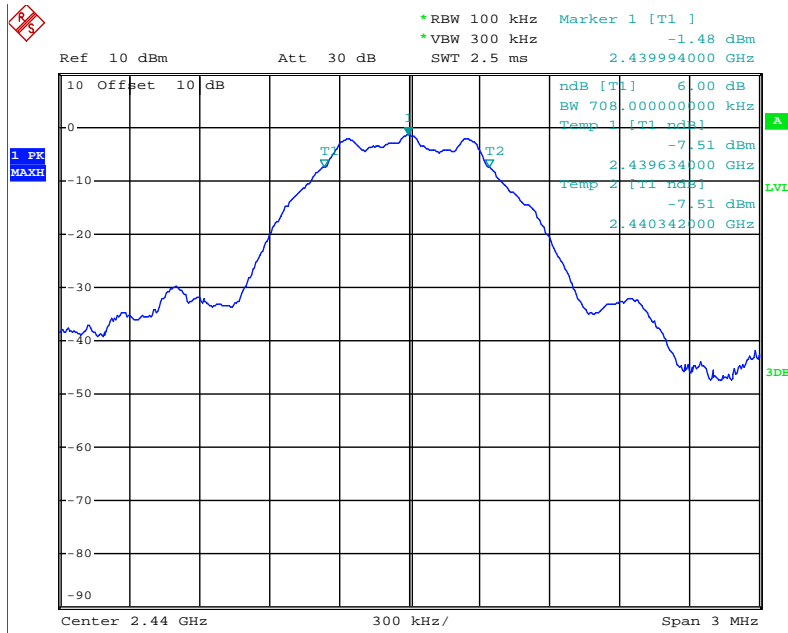

Date: 26.MAR.2020 09:43:05

channel 39

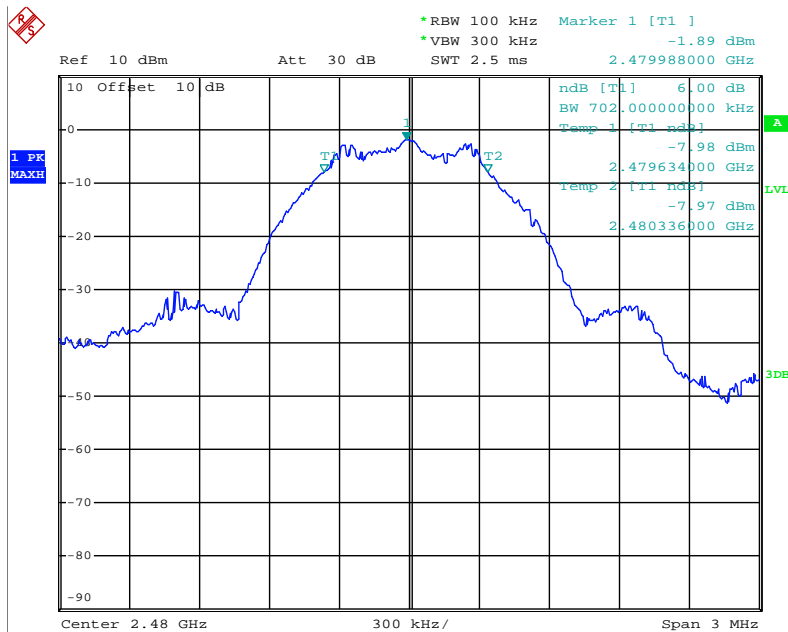

Date: 26.MAR.2020 09:41:54

6. MAXIMUM PEAK OUTPUT POWER TEST

6.1. Block Diagram of Test Setup

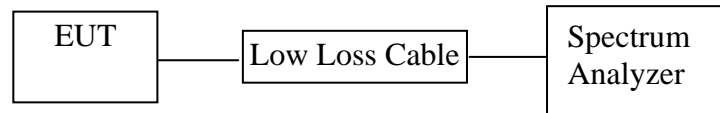

6.2. The Requirement For Section 15.247(b)(3)

Section 15.247(b)(3): For systems using digital modulation in the 902-928MHz, 2400-2483.5MHz, and 5725-5850MHz bands: 1 Watt.

6.3. EUT Configuration on Test

The equipment are installed on the emission Measurement to meet the commission requirements and operating regulations in a manner which tends to maximize its emission characteristics in normal application.

6.4. Operating Condition of EUT

6.4.1. Setup the EUT and simulator as shown as Section 6.1.

6.4.2. Turn on the power of all equipment.

6.4.3. Let the EUT work in TX modes measure it. The transmit frequency are 2402-2480MHz. We select 2402MHz, 2440MHz, and 2480MHz TX frequency to transmit.

6.5. Test Procedure

6.5.1. The transmitter output was connected to the spectrum analyzer through a low loss cable.

6.5.2. Set RBW of spectrum analyzer to 3 MHz and VBW to 10MHz.

6.5.3. Measurement the maximum peak output power.

6.6. Test Result

Channel	Frequency (MHz)	Peak Power Output (dBm)	Peak Power Limit (dBm)	Result
0	2402	-0.99	30	Pass
19	2440	-0.77	30	Pass
39	2480	-1.54	30	Pass

The spectrum analyzer plots are attached as below.

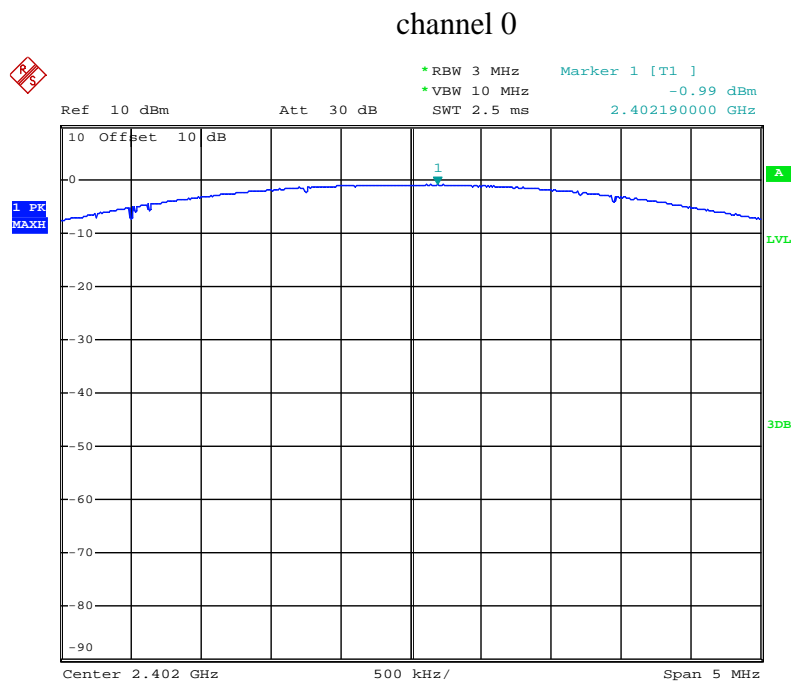

Date: 26.MAR.2020 09:35:06

channel 19

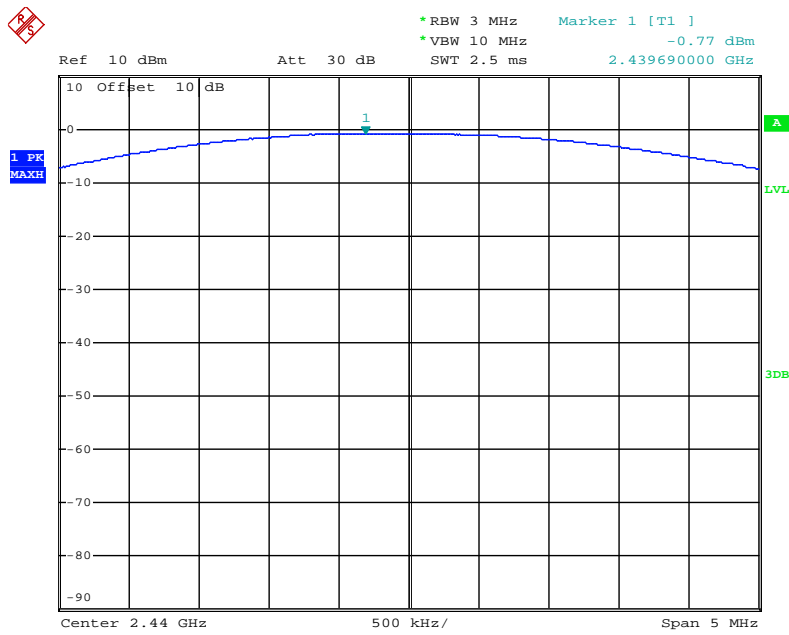

Date: 26.MAR.2020 09:34:26

channel 39

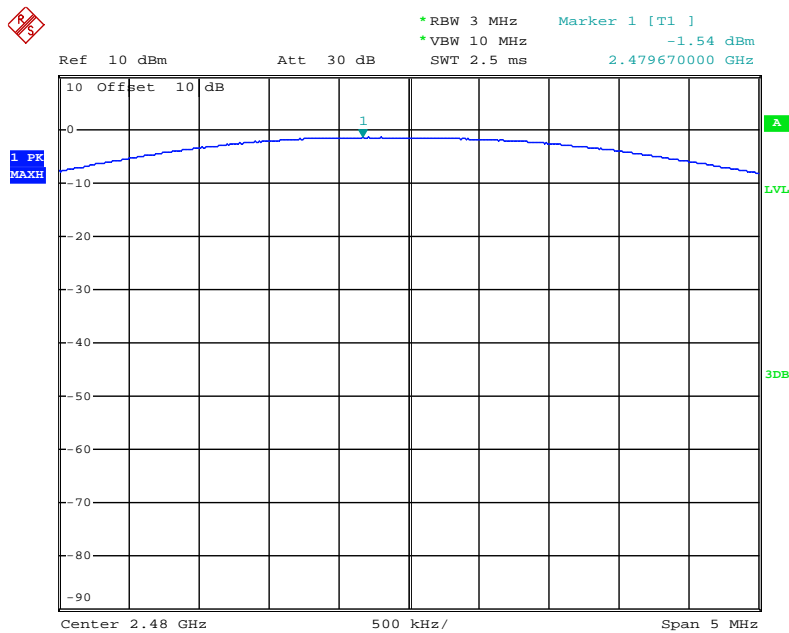

Date: 26.MAR.2020 09:35:30

7. POWER SPECTRAL DENSITY TEST

7.1. Block Diagram of Test Setup

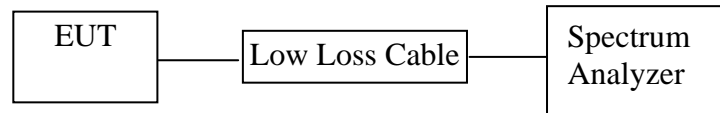

7.2. The Requirement For Section 15.247(e)

Section 15.247(e): For digitally modulated systems, the power spectral density conducted from the intentional radiator to the antenna shall not be greater than 8 dBm in any 3 kHz band during any time interval of continuous transmission.

7.3. EUT Configuration on Test

The equipment are installed on the emission Measurement to meet the commission requirements and operating regulations in a manner which tends to maximize its emission characteristics in normal application.

7.4. Operating Condition of EUT

7.4.1. Setup the EUT and simulator as shown as Section 7.1.

7.4.2. Turn on the power of all equipment.

7.4.3. Let the EUT work in TX modes measure it. The transmit frequency are 2402-2480MHz. We select 2402MHz, 2440MHz, and 2480MHz TX frequency to transmit.

7.5. Test Procedure

7.5.1. The transmitter output was connected to the spectrum analyzer through a low loss cable.

7.5.2. Measurement Procedure PKPSD:

7.5.3. This procedure must be used if maximum peak conducted output power was used to demonstrate compliance to the fundamental output power limit, and is optional if the maximum (average) conducted output power was used to demonstrate compliance.

1. Set analyzer center frequency to DTS channel center frequency.
2. Set the span to 1.5 times the DTS channel bandwidth.
3. Set the RBW to: $3 \text{ kHz} \leq \text{RBW} \leq 100 \text{ kHz}$.
4. Set the VBW $\geq 3 \times \text{RBW}$.
5. Detector = peak.
6. Sweep time = auto couple.
7. Trace mode = max hold.
8. Allow trace to fully stabilize.
9. Use the peak marker function to determine the maximum amplitude level.
10. If measured value exceeds limit, reduce RBW (no less than 3kHz) and repeat.

7.5.4. Measurement the maximum power spectral density.

7.6. Test Result

Channel	Frequency (MHz)	PSD (dBm/3KHz)	Limit (dBm/3KHz)	Result
0	2402	-17.47	8	Pass
19	2440	-16.53	8	Pass
39	2480	-18.19	8	Pass

The spectrum analyzer plots are attached as below.

channel 0

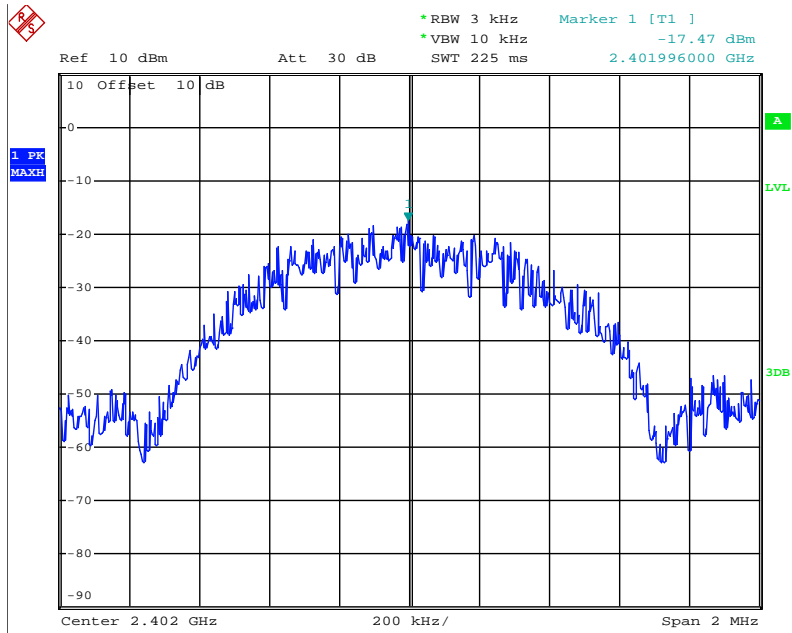

Date: 26.MAR.2020 09:38:05

channel 19

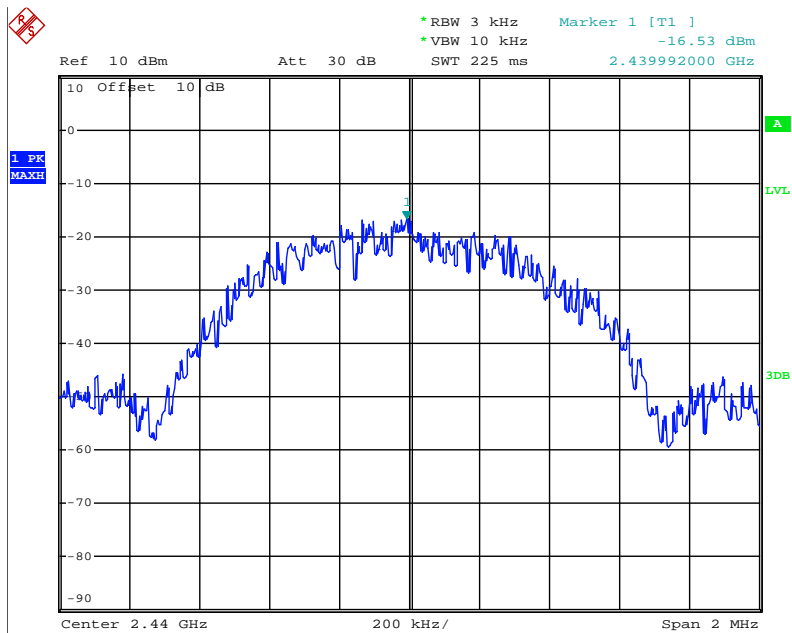

Date: 26.MAR.2020 09:37:29

channel 39

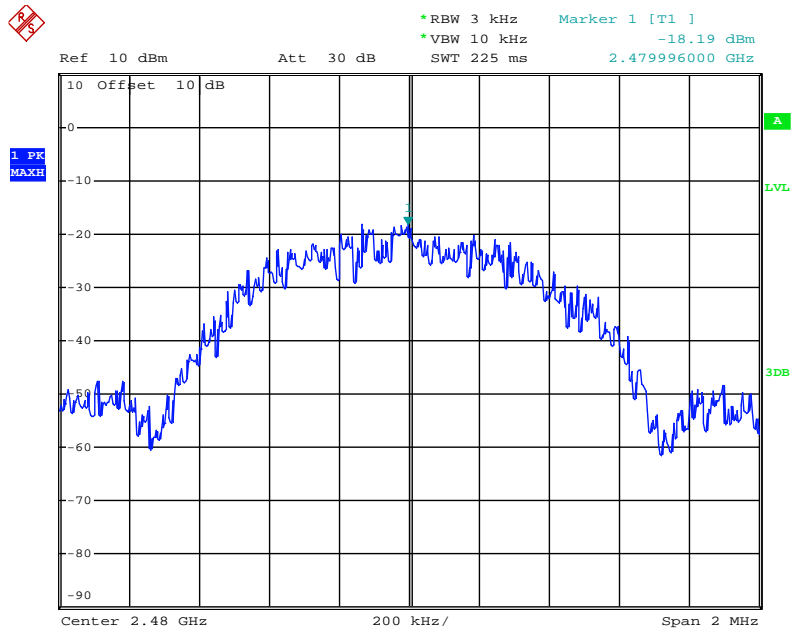

Date: 26.MAR.2020 09:36:20

8. BAND EDGE COMPLIANCE TEST

8.1. Block Diagram of Test Setup

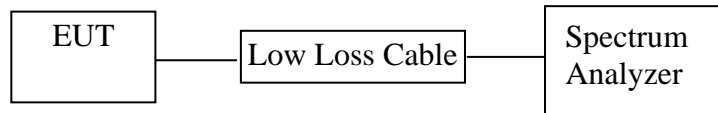

8.2. The Requirement For Section 15.247(d)

Section 15.247(d): In any 100 kHz bandwidth outside the frequency band in which the spread spectrum or digitally modulated intentional radiator is operating, the radio frequency power that is produced by the intentional radiator shall be at least 20 dB below that in the 100 kHz bandwidth within the band that contains the highest level of the desired power, based on either an RF conducted or a radiated measurement, provided the transmitter demonstrates compliance with the peak conducted power limits. If the transmitter complies with the conducted power limits based on the use of RMS averaging over a time interval, as permitted under paragraph (b)(3) of this section, the attenuation required under this paragraph shall be 30 dB instead of 20 dB. Attenuation below the general limits specified in Section 15.209(a) is not required. In addition, radiated emissions which fall in the restricted bands, as defined in Section 15.205(a), must also comply with the radiated emission limits specified in Section 15.209(a).

8.3. EUT Configuration on Test

The equipment are installed on the emission Measurement to meet the commission requirements and operating regulations in a manner which tends to maximize its emission characteristics in normal application.

8.4. Operating Condition of EUT

8.4.1. Setup the EUT and simulator as shown as Section 8.1.

8.4.2. Turn on the power of all equipment.

8.4.3. Let the EUT work in TX modes measure it. The transmit frequency are 2402-2480MHz. We select 2402MHz, 2480MHz TX frequency to transmit.

8.5. Test Procedure

Conducted Band Edge:

8.5.1. The transmitter output was connected to the spectrum analyzer via a low loss cable.

8.5.2. Set RBW of spectrum analyzer to 100 kHz and VBW to 300 kHz.

Radiate Band Edge:

8.5.3. The EUT is placed on a turntable, which is 0.1m above the ground plane and worked at highest radiated power.

8.5.4. The turntable was rotated for 360 degrees to determine the position of maximum emission level.

8.5.5. EUT is set 3m away from the receiving antenna, which is varied from 1m to 4m to find out the highest emission.

8.5.6. Set the spectrum analyzer in the following setting in order to capture the lower and upper band-edges of the emission:

8.5.7. RBW=1MHz, VBW=1MHz

8.5.8. The band edges was measured and recorded.

8.6. Test Result

Conducted Band Edge Result

Channel	Frequency	Delta peak to band emission	Limit(dBc)	Result
0	2.402GHz	42.43	>20	Pass
39	2.480GHz	56.98	>20	Pass

The spectrum analyzer plots are attached as below.

channel 0

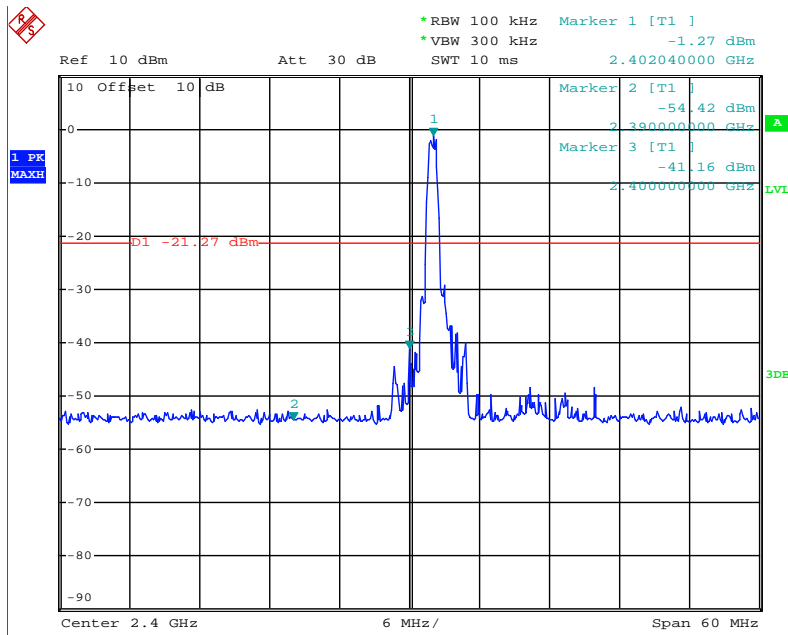

Date: 26.MAR.2020 09:39:09

channel 39

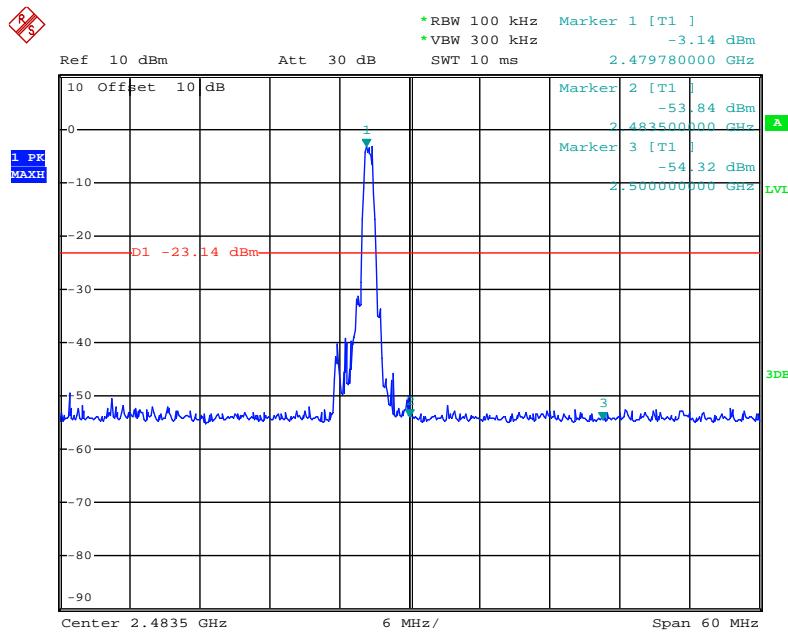

Date: 26.MAR.2020 09:40:25

Radiated Band Edge Result

ACCURATE TECHNOLOGY CO., LTD.

 F1,Bldg,A,Changyuan New Material Port Keyuan Rd,
 Science & Industry Park,Nanshan Shenzhen,P.R.China

Site: 1# Chamber

Tel:+86-0755-26503290

Fax:+86-0755-26503396

 Job No.: emc #94
 Standard: FCC PK
 Test item: Radiation Test
 Temp.(C)/Hum.(%) 25 C / 55 %
 EUT: Bluemini Bluetooth Dongle
 Mode: TX2402MHz
 Model: Bluemini
 Manufacturer: Head-Direct(Kunshan)Co.,LTD

 Polarization: Vertical
 Power Source: DC 3.7V
 Date: 20/03/20/
 Time: 15/52/44
 Engineer Signature:
 Distance: 3m

Note: Report NO.:ATE20200222

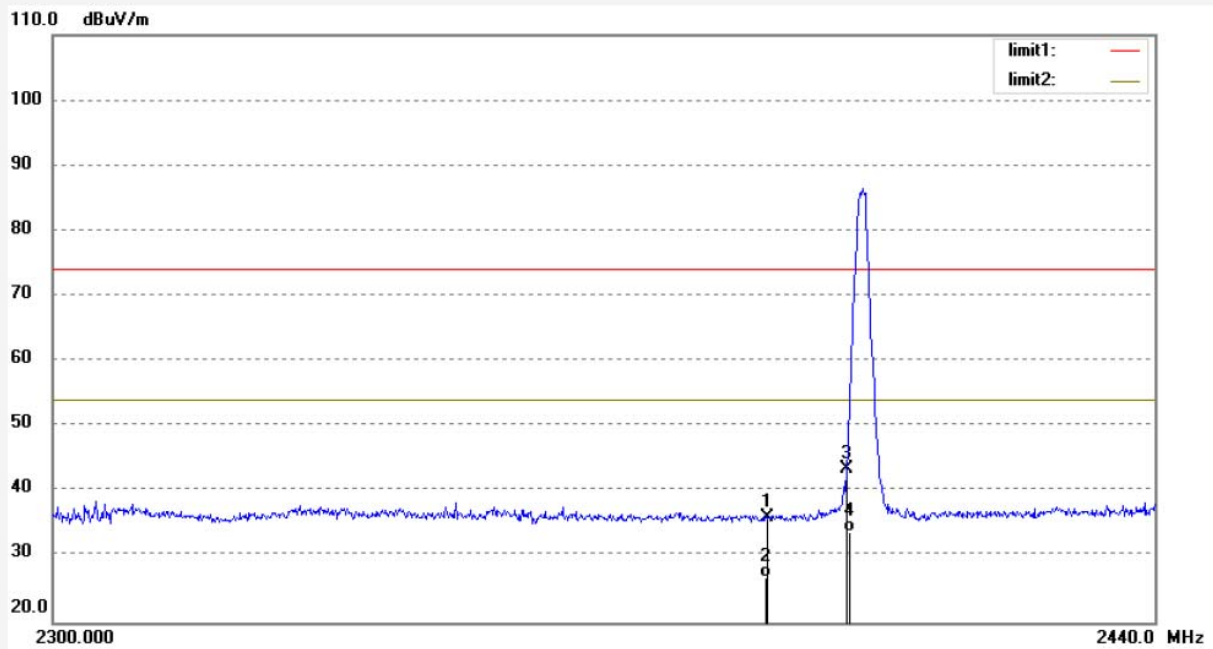

No.	Freq. (MHz)	Reading (dBuV/m)	Factor (dB)	Result (dBuV/m)	Limit (dBuV/m)	Margin (dB)	Detector	Height (cm)	Degree (deg.)	Remark
1	2390.000	42.34	-6.32	36.02	74.00	-37.98	peak	150	82	
2	2390.000	33.21	-6.32	26.89	54.00	-27.11	AVG	150	215	
3	2400.000	49.84	-6.27	43.57	74.00	-30.43	peak	150	66	
4	2400.000	40.10	-6.27	33.83	54.00	-20.17	AVG	150	146	



ACCURATE TECHNOLOGY CO., LTD.

F1,Bldg,A,Changyuan New Material Port Keyuan Rd,
Science & Industry Park,Nanshan Shenzhen,P.R.China

Site: 1# Chamber
Tel:+86-0755-26503290
Fax:+86-0755-26503396

Job No.: emc #95	Polarization: Horizontal
Standard: FCC PK	Power Source: DC 3.7V
Test item: Radiation Test	Date: 20/03/20/
Temp.(C)/Hum.(%) 25 C / 55 %	Time: 15/52/51
EUT: Bluemini Bluetooth Dongle	Engineer Signature:
Mode: TX2402MHz	Distance: 3m
Model: Bluemini	
Manufacturer: Head-Direct(Kunshan)Co.,LTD	

Note: Report NO.:ATE20200222

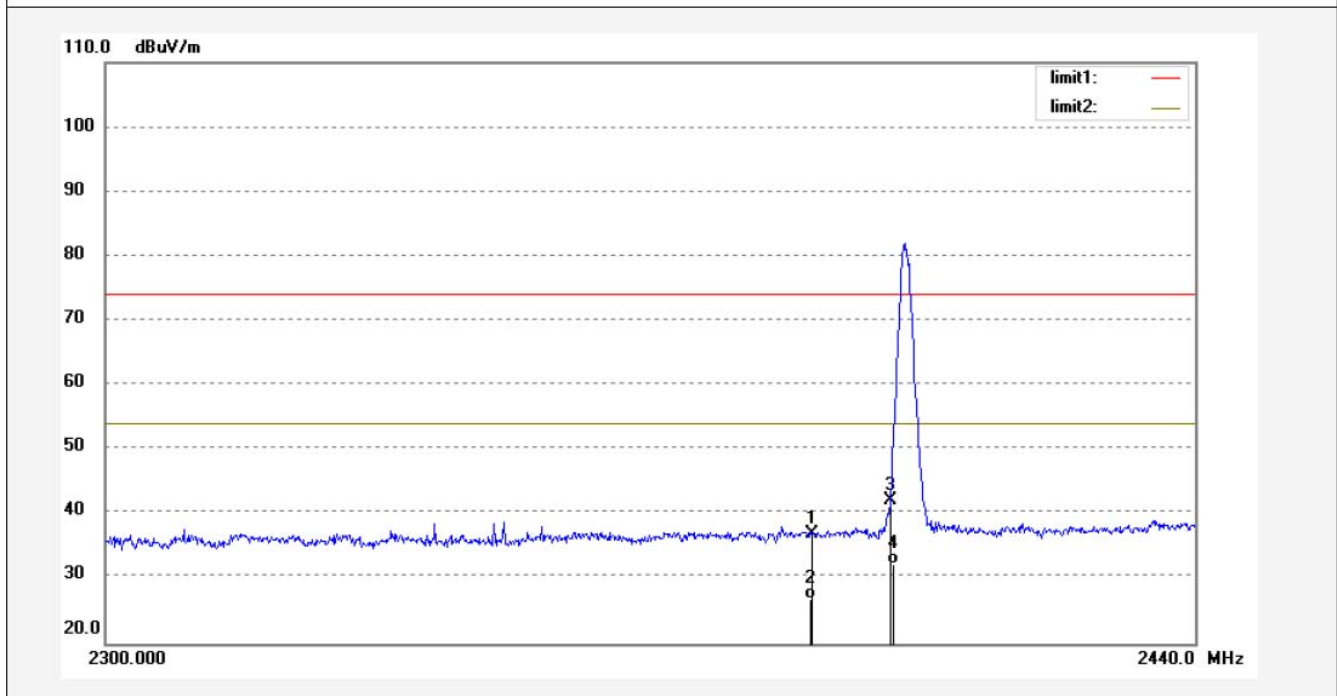

No.	Freq. (MHz)	Reading (dBuV/m)	Factor (dB)	Result (dBuV/m)	Limit (dBuV/m)	Margin (dB)	Detector	Height (cm)	Degree (deg.)	Remark
1	2390.000	43.34	-6.32	37.02	74.00	-36.98	peak	200	41	
2	2390.000	33.24	-6.32	26.92	54.00	-27.08	AVG	200	22	
3	2400.000	48.34	-6.27	42.07	74.00	-31.93	peak	200	321	
4	2400.000	38.46	-6.27	32.19	54.00	-21.81	AVG	200	109	

Job No.: emc #86

Standard: FCC PK

Test item: Radiation Test

Temp.(C)/Hum.(%) 25 C / 55 %

EUT: Bluemini Bluetooth Dongle

Mode: TX2480MHz

Model: Bluemini

Manufacturer: Head-Direct(Kunshan)Co.,LTD

Polarization: Vertical

Power Source: DC 3.7V

Date: 20/03/20/

Time: 15/47/39

Engineer Signature:

Distance: 3m

Note: Report NO.:ATE20200222

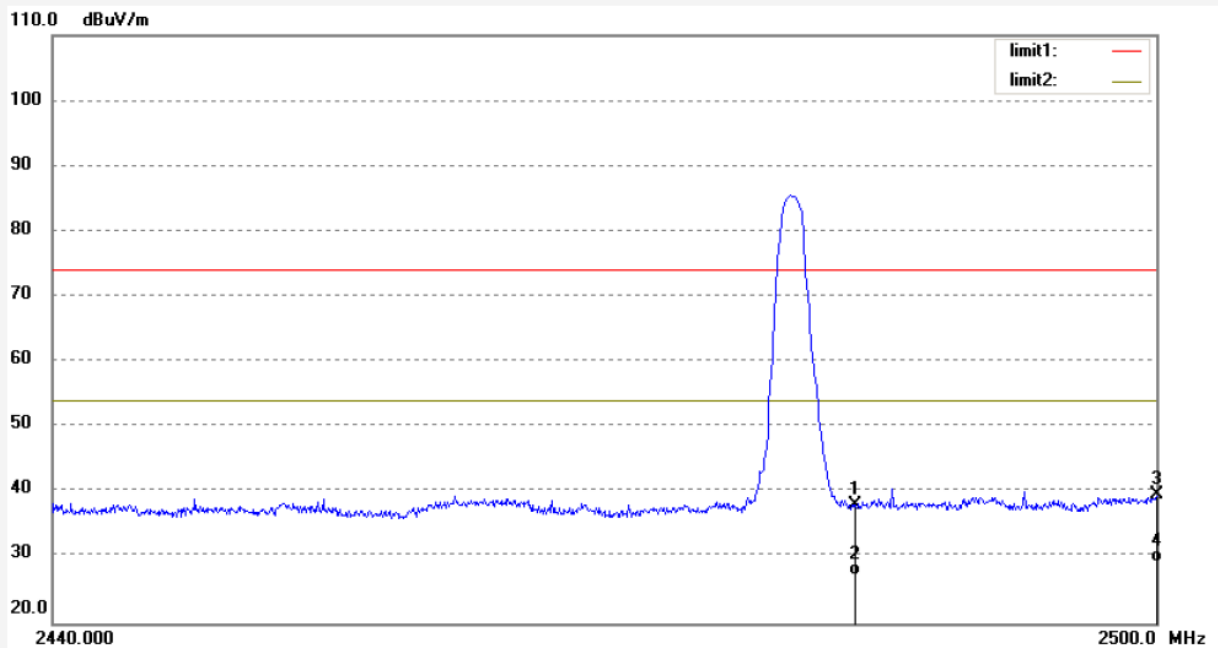

No.	Freq. (MHz)	Reading (dBuV/m)	Factor (dB)	Result (dBuV/m)	Limit (dBuV/m)	Margin (dB)	Detector	Height (cm)	Degree (deg.)	Remark
1	2483.500	43.99	-5.89	38.10	74.00	-35.90	peak	150	105	
2	2483.500	33.24	-5.89	27.35	54.00	-26.65	AVG	150	62	
3	2500.000	45.47	-5.81	39.66	74.00	-34.34	peak	150	118	
4	2500.000	35.12	-5.81	29.31	54.00	-24.69	AVG	150	163	



ACCURATE TECHNOLOGY CO., LTD.

F1,Bldg,A,Changyuan New Material Port Keyuan Rd,
Science & Industry Park,Nanshan Shenzhen,P.R.China

Site: 1# Chamber

Tel:+86-0755-26503290

Fax:+86-0755-26503396

Job No.: emc #87	Polarization: Horizontal
Standard: FCC PK	Power Source: DC 3.7V
Test item: Radiation Test	Date: 20/03/20/
Temp.(C)/Hum.(%) 25 C / 55 %	Time: 15/47/55
EUT: Bluemini Bluetooth Dongle	Engineer Signature:
Mode: TX2480MHz	Distance: 3m
Model: Bluemini	
Manufacturer: Head-Direct(Kunshan)Co.,LTD	

Note: Report NO.:ATE20200222

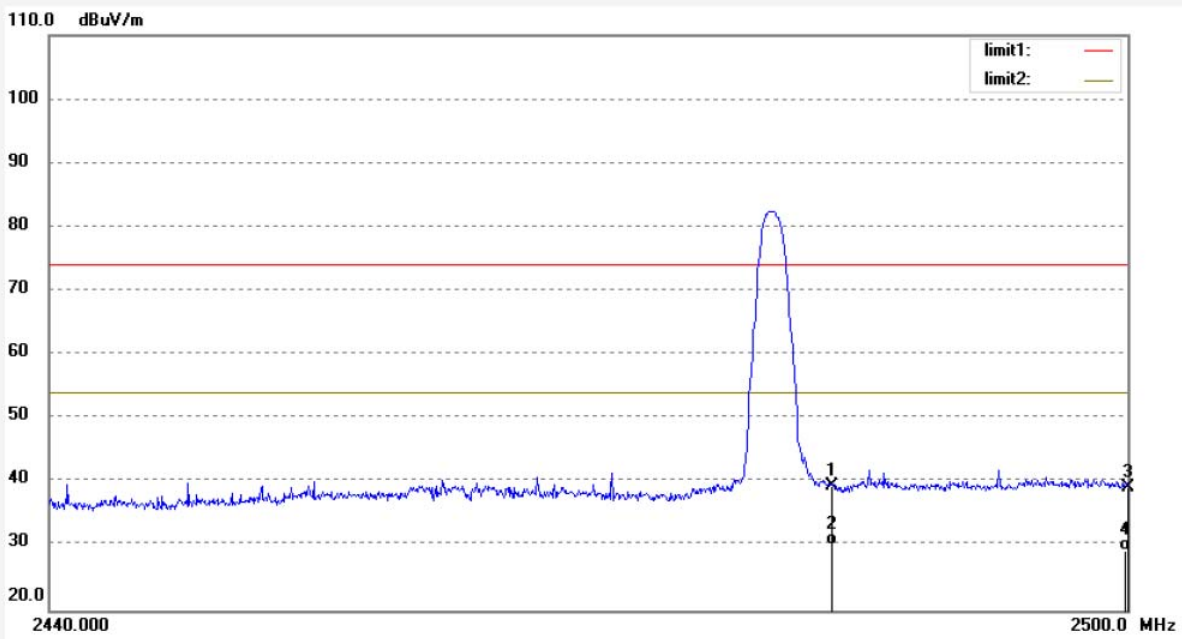

No.	Freq. (MHz)	Reading (dBuV/m)	Factor (dB)	Result (dBuV/m)	Limit (dBuV/m)	Margin (dB)	Detector	Height (cm)	Degree (deg.)	Remark
1	2483.500	45.29	-5.89	39.40	74.00	-34.60	peak	200	92	
2	2483.500	36.12	-5.89	30.23	54.00	-23.77	AVG	200	115	
3	2500.000	45.15	-5.81	39.34	74.00	-34.66	peak	200	62	
4	2500.000	35.12	-5.81	29.31	54.00	-24.69	AVG	200	103	

Note:

1. Emissions attenuated more than 20 dB below the permissible value are not reported.
2. The field strength is calculated by adding the antenna factor, high pass filter loss(if used) and cable loss, and subtracting the amplifier gain(if any)from the measured reading. The basic equation calculation is as follows:

$$\text{Result} = \text{Reading} + \text{Corrected Factor}$$

9. RADIATED SPURIOUS EMISSION TEST

9.1. Block Diagram of Test Setup

9.1.1. Block diagram of connection between the EUT and peripherals

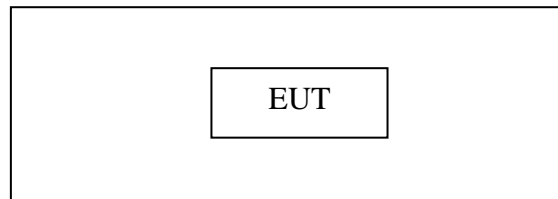

Setup: Transmitting mode

9.1.2. Semi-Anechoic Chamber Test Setup Diagram

(A) Radiated Emission Test Set-Up, Frequency below 30MHz

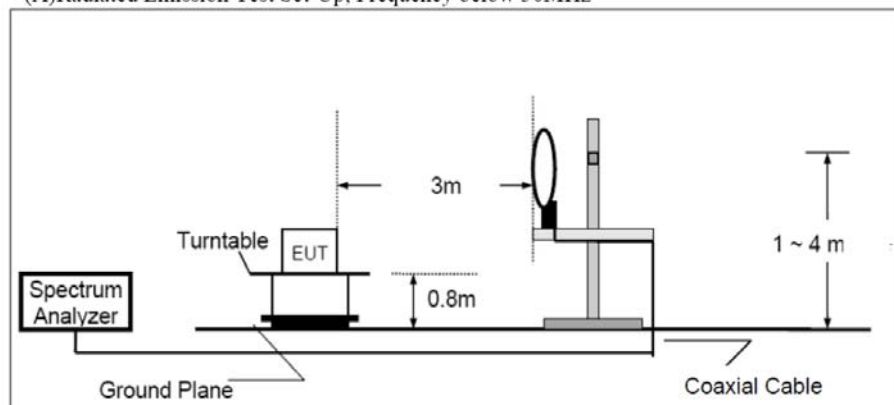

(B) Radiated Emission Test Set-Up, Frequency 30MHz-1GHz

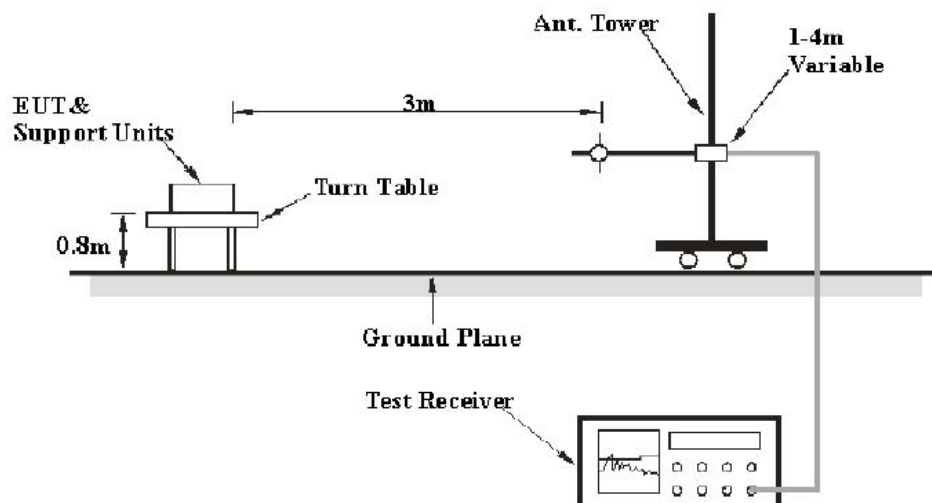

(C) Radiated Emission Test Set-Up, Frequency above 1GHz

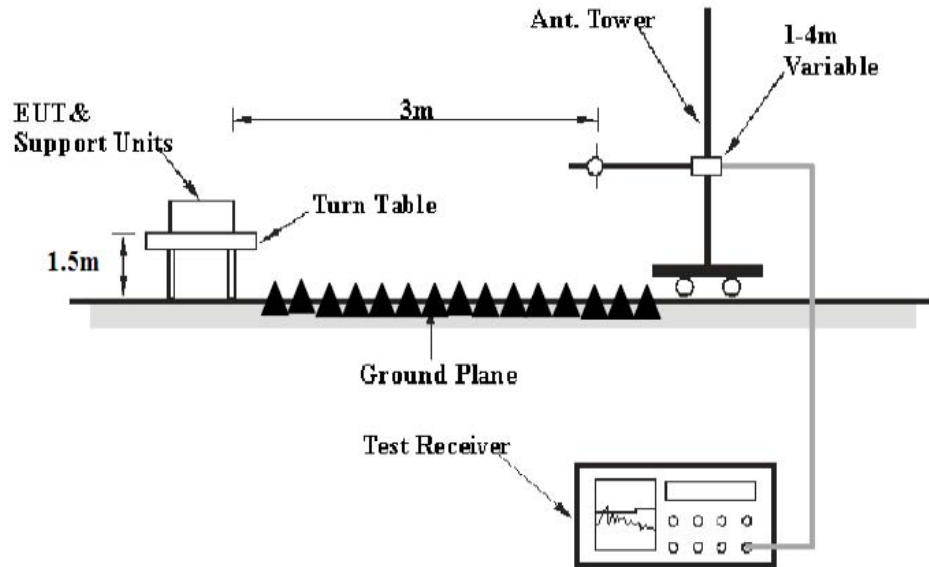

9.2. The Limit For Section 15.247(d)

Section 15.247(d): In any 100 kHz bandwidth outside the frequency band in which the spread spectrum or digitally modulated intentional radiator is operating, the radio frequency power that is produced by the intentional radiator shall be at least 20 dB below that in the 100 kHz bandwidth within the band that contains the highest level of the desired power, based on either an RF conducted or a radiated measurement, provided the transmitter demonstrates compliance with the peak conducted power limits. If the transmitter complies with the conducted power limits based on the use of RMS averaging over a time interval, as permitted under paragraph (b)(3) of this section, the attenuation required under this paragraph shall be 30 dB instead of 20 dB. Attenuation below the general limits specified in Section 15.209(a) is not required. In addition, radiated emissions which fall in the restricted bands, as defined in Section 15.205(a), must also comply with the radiated emission limits specified in Section 15.209(a).

9.3. Restricted bands of operation

9.3.1.FCC Part 15.205 Restricted bands of operation

(a) Except as shown in paragraph (d) of this section, Only spurious emissions are permitted in any of the frequency bands listed below:

MHz	MHz	MHz	GHz
0.090-0.110	16.42-16.423	399.9-410	4.5-5.15
¹ 0.495-0.505	16.69475-16.69525	608-614	5.35-5.46
2.1735-2.1905	16.80425-16.80475	960-1240	7.25-7.75
4.125-4.128	25.5-25.67	1300-1427	8.025-8.5
4.17725-4.17775	37.5-38.25	1435-1626.5	9.0-9.2
4.20725-4.20775	73-74.6	1645.5-1646.5	9.3-9.5
6.215-6.218	74.8-75.2	1660-1710	10.6-12.7
6.26775-6.26825	108-121.94	1718.8-1722.2	13.25-13.4
6.31175-6.31225	123-138	2200-2300	14.47-14.5
8.291-8.294	149.9-150.05	2310-2390	15.35-16.2
8.362-8.366	156.52475-156.52525	2483.5-2500	17.7-21.4
8.37625-8.38675	156.7-156.9	2690-2900	22.01-23.12
8.41425-8.41475	162.0125-167.17	3260-3267	23.6-24.0
12.29-12.293	167.72-173.2	3332-3339	31.2-31.8
12.51975-12.52025	240-285	3345.8-3358	36.43-36.5
12.57675-12.57725	322-335.4	3600-4400	(²)
13.36-13.41			

¹Until February 1, 1999, this restricted band shall be 0.490-0.510

²Above 38.6

(b) Except as provided in paragraphs (d) and (e), the field strength of emission appearing within these frequency bands shall not exceed the limits shown in Section 15.209. At frequencies equal to or less than 1000MHz, Compliance with the limits in Section 15.209 shall be demonstrated using measurement instrumentation employing a CISPR quasi-peak detector. Above 1000MHz, compliance with the emission limits in Section 15.209 shall be demonstrated based on the average value of the measured emissions. The provisions in Section 15.35 apply to these measurements.

9.4.Configuration of EUT on Test

The equipment are installed on Radiated Emission Measurement to meet the commission requirements and operating regulations in a manner which tends to maximize its emission characteristics in normal application.

9.5. Operating Condition of EUT

9.5.1. Setup the EUT and simulator as shown as Section 9.1.

9.5.2. Turn on the power of all equipment.

9.5.3. Let the EUT work in TX modes measure it. The transmit frequency are 2402-2480MHz. We select 2402MHz, 2440MHz, and 2480MHz TX frequency to transmit.

9.6. Test Procedure

The EUT and its simulators are placed on a turntable, which is 0.8 meter high above ground (Below 1GHz). The EUT and its simulators are placed on a turntable, which is 1.5 meter high above ground (Above 1GHz). The turntable can rotate 360 degrees to determine the position of the maximum emission level. EUT is set 3.0 meters away from the receiving antenna, which is mounted on an antenna tower. The antenna can be moved up and down between 1.0 meter and 4 meters to find out the maximum emission level. Broadband antenna (calibrated bi-log antenna) is used as receiving antenna. Both horizontal and vertical polarizations of the antenna are set on measurement. In order to find the maximum emission levels, all of the EUT location must be manipulated according to ANSI C63.10:2013 on radiated emission measurement. This EUT was tested in 3 orthogonal positions and the worst case position data was reported.

The bandwidth of test receiver is set at 9 kHz in below 30MHz. and set at 120 kHz in 30-1000MHz, and 1MHz in above 1000MHz.

The final measurement in band 9-90 kHz, 110-490 kHz and above 1000MHz is performed with Average detector. Except those frequency bands mention above, the final measurement for frequencies below 1000MHz is performed with Quasi Peak detector. The field strength is calculated by adding the antenna factor, and cable loss, and subtracting the amplifier gain from the measured reading.

9.7.Data Sample

Frequency (MHz)	Reading (dB μ v)	Factor (dB/m)	Result (dB μ v/m)	Limit (dB μ v/m)	Margin (dB)	Remark
X.XX	43.85	-22.22	21.63	43.5	-21.87	QP

Frequency(MHz) = Emission frequency in MHz

Reading(dB μ v) = Uncorrected Analyzer/Receiver reading

Factor (dB/m) = Antenna factor + Cable Loss – Amplifier gain

Result(dB μ v/m) = Reading(dB μ v) + Factor(dB/m)

Limit (dB μ v/m) = Limit stated in standard

Margin (dB) = Result(dB μ v/m) - Limit (dB μ v/m)

QP = Quasi-peak Reading

Calculation Formula:

Margin(dB) = Result (dB μ V/m)–Limit(dB μ V/m)

Result(dB μ V/m)= Reading(dB μ V)+ Factor(dB/m)

The “Margin” column of the following data tables indicates the degree of compliance with the applicable limit. For example, a margin of -7dB means the emission is 7dB below the limit.

9.8.Test Result

Pass.

Testing is carried out with frequency rang 9kHz to the tenth harmonics, which above 3th Harmonics are attenuated more than 20dB below the permissible limits or the field strength is too small to be measured.

The measurements greater than 20dB below the limit from 9kHz to 30MHz and 18 to 26.5GHz.

The spectrum analyzer plots are attached as below.

Below 1GHz

ACCURATE TECHNOLOGY CO., LTD.

 F1,Bldg,A,Changyuan New Material Port Keyuan Rd,
 Science & Industry Park,Nanshan Shenzhen,P.R.China

 Site: 2# Chamber
 Tel:+86-0755-26503290
 Fax:+86-0755-26503396

Job No.: emc #104

Standard: FCC Class B 3M Radiated

Test item: Radiation Test

Temp.(C)/Hum.(%) 23 C / 48 %

EUT: Bluemini Bluetooth Dongle

Mode: TX2402MHz

Model: Bluemini

Manufacturer: Head-Direct(Kunshan)Co.,LTD

Polarization: Horizontal

Power Source: DC 3.7V

Date: 2020/03/24

Time: 17:23:13

Engineer Signature:

Distance: 3m

Note: Report NO.:ATE20200222

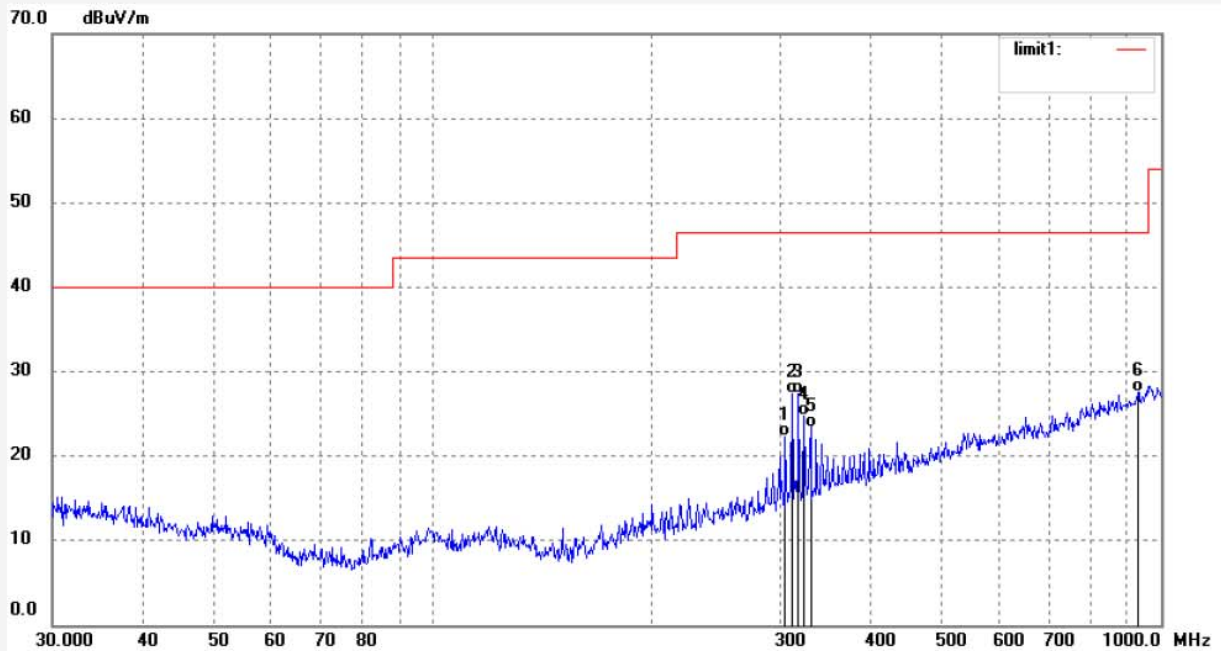

No.	Freq. (MHz)	Reading (dBuV/m)	Factor (dB)	Result (dBuV/m)	Limit (dBuV/m)	Margin (dB)	Detector	Height (cm)	Degree (deg.)	Remark
1	304.6099	32.58	-10.21	22.37	46.50	-24.13	QP	200	302	
2	311.0867	37.31	-9.99	27.32	46.50	-19.18	QP	200	213	
3	317.7010	37.22	-9.81	27.41	46.50	-19.09	QP	200	63	
4	323.3204	34.40	-9.61	24.79	46.50	-21.71	QP	200	126	
5	330.1949	32.79	-9.34	23.45	46.50	-23.05	QP	200	201	
6	929.0081	26.80	0.82	27.62	46.50	-18.88	QP	200	103	

ACCURATE TECHNOLOGY CO., LTD.

 F1,Bldg,A,Changyuan New Material Port Keyuan Rd,
 Science & Industry Park,Nanshan Shenzhen,P.R.China

 Site: 2# Chamber
 Tel:+86-0755-26503290
 Fax:+86-0755-26503396

Job No.: emc #105

Standard: FCC Class B 3M Radiated

Test item: Radiation Test

Temp.(C)/Hum.(%) 23 C / 48 %

EUT: Bluemini Bluetooth Dongle

Mode: TX2402MHz

Model: Bluemini

Manufacturer: Head-Direct(Kunshan)Co.,LTD

Polarization: Vertical

Power Source: DC 3.7V

Date: 2020/03/24

Time: 17:23:37

Engineer Signature:

Distance: 3m

Note: Report NO.:ATE20200222

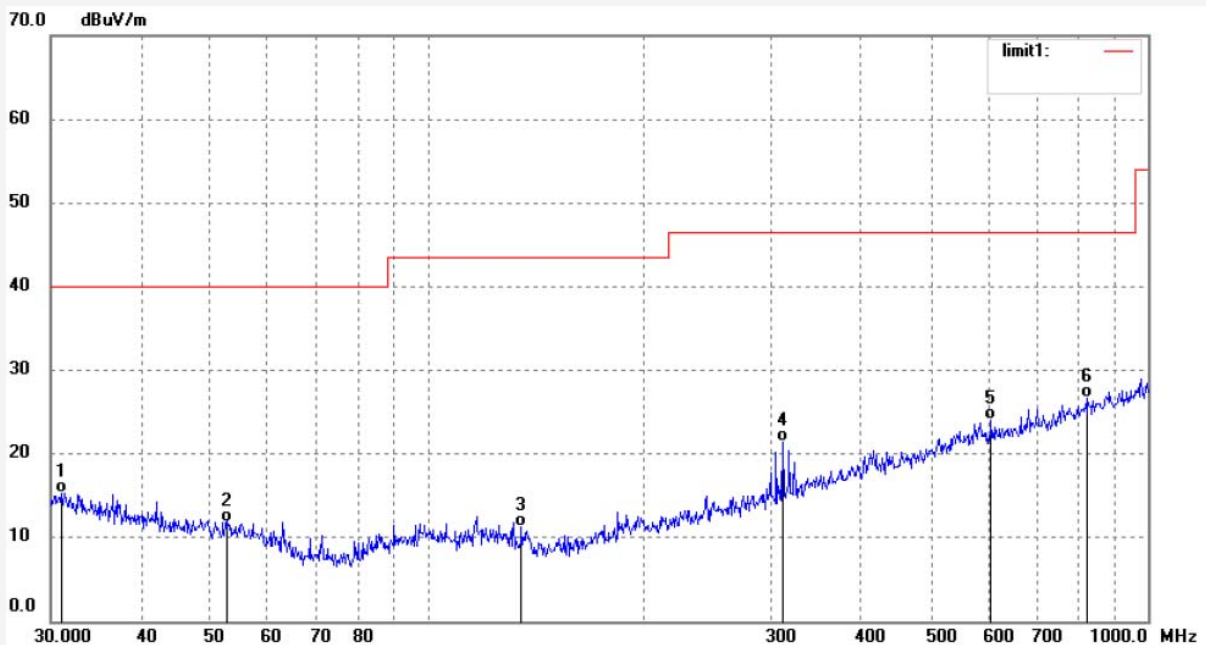

No.	Freq. (MHz)	Reading (dBuV/m)	Factor (dB)	Result (dBuV/m)	Limit (dBuV/m)	Margin (dB)	Detector	Height (cm)	Degree (deg.)	Remark
1	31.0705	25.53	-10.25	15.28	40.00	-24.72	QP	100	103	
2	52.7599	25.71	-13.81	11.90	40.00	-28.10	QP	100	201	
3	135.0319	26.41	-15.08	11.33	43.50	-32.17	QP	100	82	
4	311.0867	31.46	-9.99	21.47	46.50	-25.03	QP	100	61	
5	605.6592	27.96	-3.90	24.06	46.50	-22.44	QP	100	221	
6	824.5968	27.29	-0.58	26.71	46.50	-19.79	QP	100	163	



ACCURATE TECHNOLOGY CO., LTD.

F1,Bldg,A,Changyuan New Material Port Keyuan Rd,
Science & Industry Park,Nanshan Shenzhen,P.R.China

Site: 2# Chamber
Tel:+86-0755-26503290
Fax:+86-0755-26503396

Job No.: emc #106

Standard: FCC Class B 3M Radiated

Test item: Radiation Test

Temp.(C)/Hum.(%) 23 C / 48 %

EUT: Bluemini Bluetooth Dongle

Mode: TX2440MHz

Model: Bluemini

Manufacturer: Head-Direct(Kunshan)Co.,LTD

Polarization: Vertical

Power Source: DC 3.7V

Date: 2020/03/24

Time: 17:23:48

Engineer Signature:

Distance: 3m

Note: Report NO.:ATE20200222

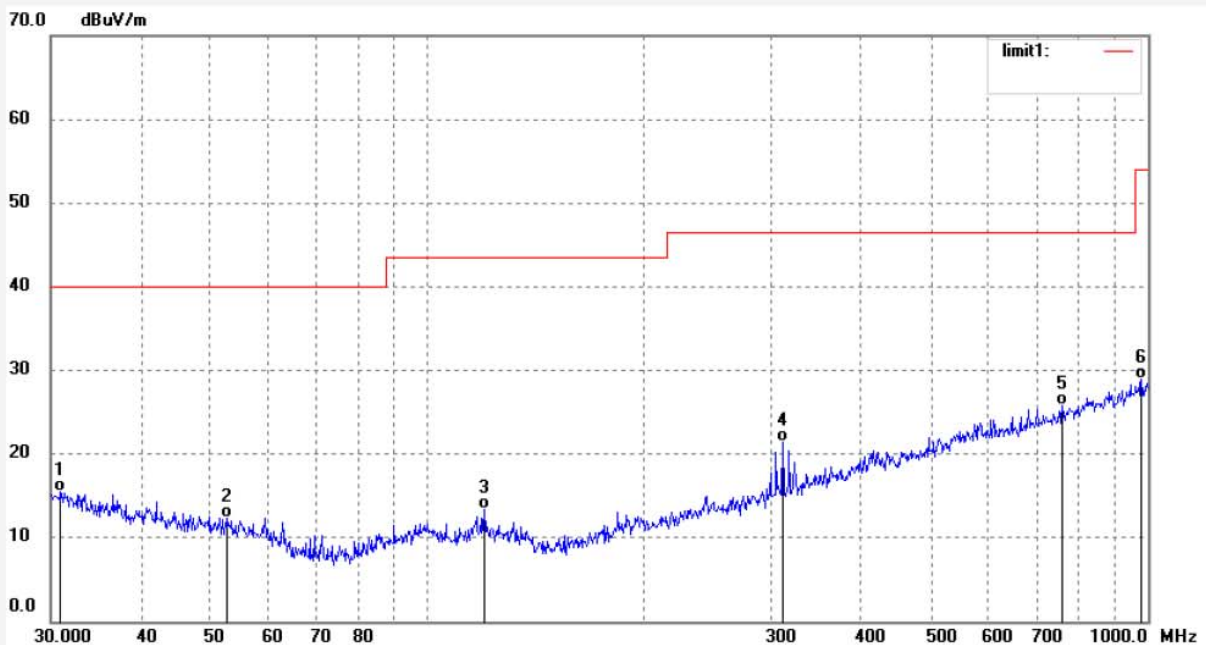

No.	Freq. (MHz)	Reading (dBuV/m)	Factor (dB)	Result (dBuV/m)	Limit (dBuV/m)	Margin (dB)	Detector	Height (cm)	Degree (deg.)	Remark
1	30.9618	25.75	-10.21	15.54	40.00	-24.46	QP	100	216	
2	52.7599	26.15	-13.81	12.34	40.00	-27.66	QP	100	89	
3	119.8555	27.50	-14.15	13.35	43.50	-30.15	QP	100	221	
4	311.0867	31.46	-9.99	21.47	46.50	-25.03	QP	100	30	
5	760.7036	27.65	-1.86	25.79	46.50	-20.71	QP	100	123	
6	979.1803	27.39	1.59	28.98	54.00	-25.02	QP	100	102	

Job No.: emc #107	Polarization: Horizontal
Standard: FCC Class B 3M Radiated	Power Source: DC 3.7V
Test item: Radiation Test	Date: 2020/03/24
Temp.(C)/Hum.(%) 23 C / 48 %	Time: 17:23:59
EUT: Bluemini Bluetooth Dongle	Engineer Signature:
Mode: TX2440MHz	Distance: 3m
Model: Bluemini	
Manufacturer: Head-Direct(Kunshan)Co.,LTD	

Note: Report NO.:ATE20200222

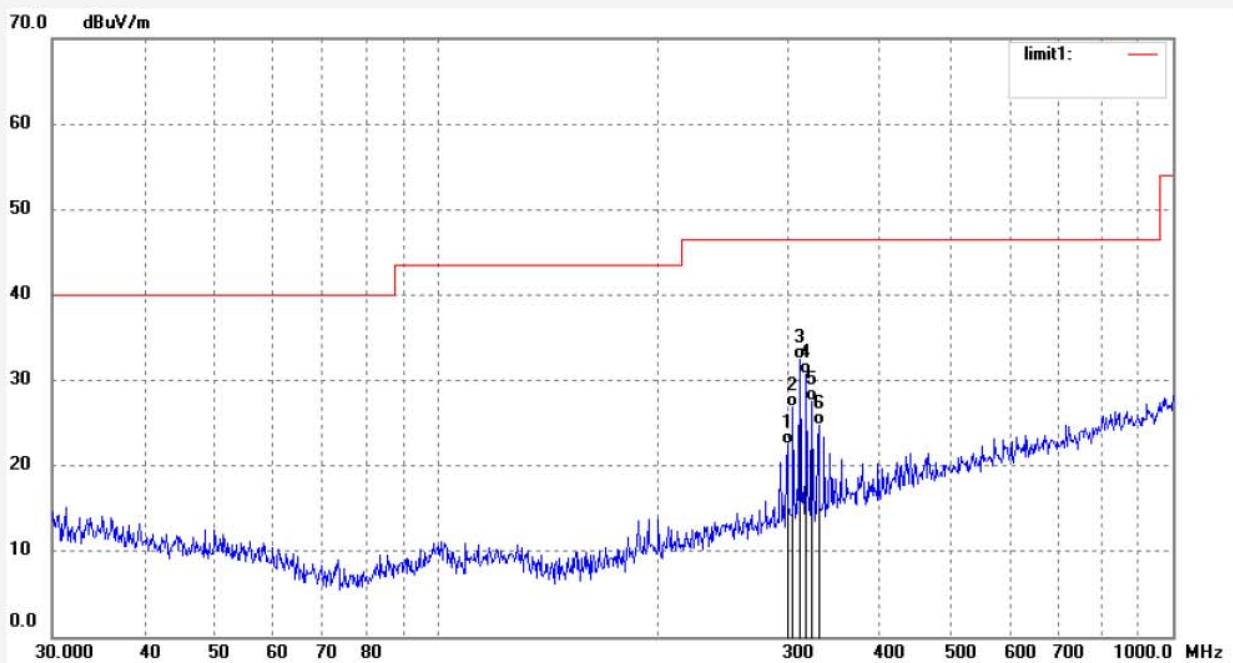

No.	Freq. (MHz)	Reading (dBuV/m)	Factor (dB)	Result (dBuV/m)	Limit (dBuV/m)	Margin (dB)	Detector	Height (cm)	Degree (deg.)	Remark
1	299.3158	32.73	-10.29	22.44	46.50	-24.06	QP	200	146	
2	304.6099	37.07	-10.21	26.86	46.50	-19.64	QP	200	306	
3	311.0867	42.38	-9.99	32.39	46.50	-14.11	QP	200	216	
4	317.7010	40.54	-9.81	30.73	46.50	-15.77	QP	200	22	
5	323.3204	37.15	-9.61	27.54	46.50	-18.96	QP	200	108	
6	330.1949	34.02	-9.34	24.68	46.50	-21.82	QP	200	81	



ACCURATE TECHNOLOGY CO., LTD.

F1,Bldg,A,Changyuan New Material Port Keyuan Rd,
Science & Industry Park,Nanshan Shenzhen,P.R.China

Site: 2# Chamber

Tel:+86-0755-26503290

Fax:+86-0755-26503396

Job No.: emc #108

Standard: FCC Class B 3M Radiated

Test item: Radiation Test

Temp.(C)/Hum.(%) 23 C / 48 %

EUT: Bluemini Bluetooth Dongle

Mode: TX2480MHz

Model: Bluemini

Manufacturer: Head-Direct(Kunshan)Co.,LTD

Polarization: Horizontal

Power Source: DC 3.7V

Date: 2020/03/24

Time: 17:24:09

Engineer Signature:

Distance: 3m

Note: Report NO.:ATE20200222

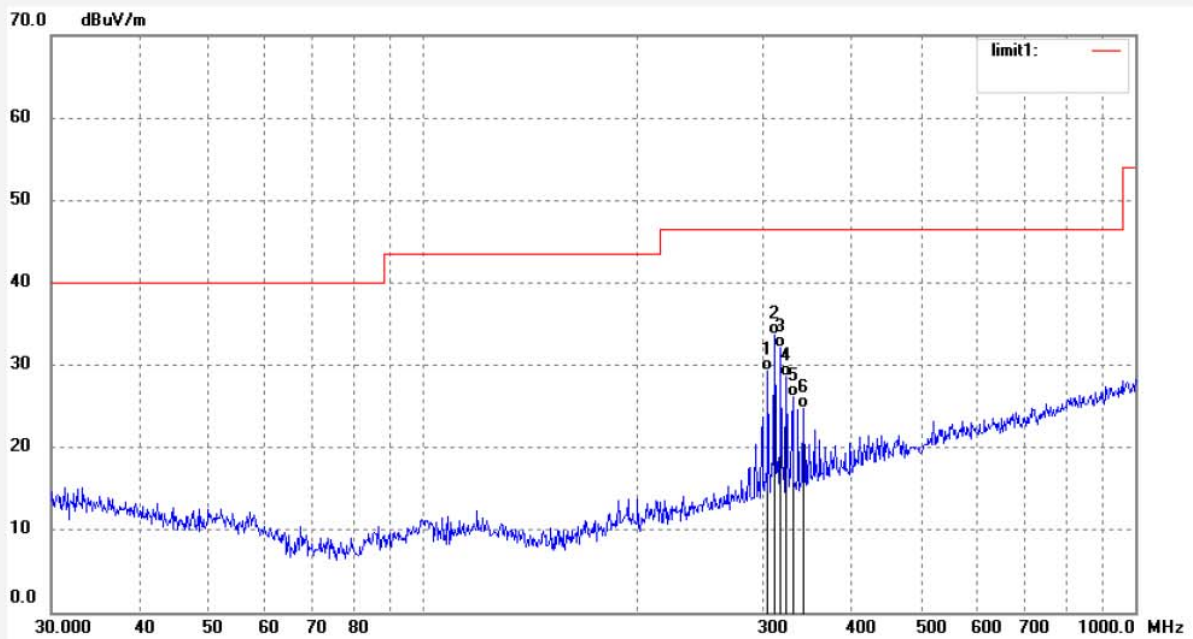

No.	Freq. (MHz)	Reading (dBuV/m)	Factor (dB)	Result (dBuV/m)	Limit (dBuV/m)	Margin (dB)	Detector	Height (cm)	Degree (deg.)	Remark
1	304.6099	39.59	-10.21	29.38	46.50	-17.12	QP	200	298	
2	311.0867	43.70	-9.99	33.71	46.50	-12.79	QP	200	118	
3	317.7010	41.91	-9.81	32.10	46.50	-14.40	QP	200	201	
4	323.3204	38.16	-9.61	28.55	46.50	-17.95	QP	200	96	
5	330.1949	35.44	-9.34	26.10	46.50	-20.40	QP	200	215	
6	341.9786	33.68	-9.00	24.68	46.50	-21.82	QP	200	103	



ACCURATE TECHNOLOGY CO., LTD.

F1,Bldg,A,Changyuan New Material Port Keyuan Rd,
Science & Industry Park,Nanshan Shenzhen,P.R.China

Site: 2# Chamber
Tel:+86-0755-26503290
Fax:+86-0755-26503396

Job No.: emc #109
Standard: FCC Class B 3M Radiated
Test item: Radiation Test
Temp.(C)/Hum.(%) 23 C / 48 %
EUT: Bluemini Bluetooth Dongle
Mode: TX2480MHz
Model: Bluemini
Manufacturer: Head-Direct(Kunshan)Co.,LTD

Polarization: Vertical
Power Source: DC 3.7V
Date: 2020/03/24
Time: 17:24:31
Engineer Signature:
Distance: 3m

Note: Report NO.:ATE20200222

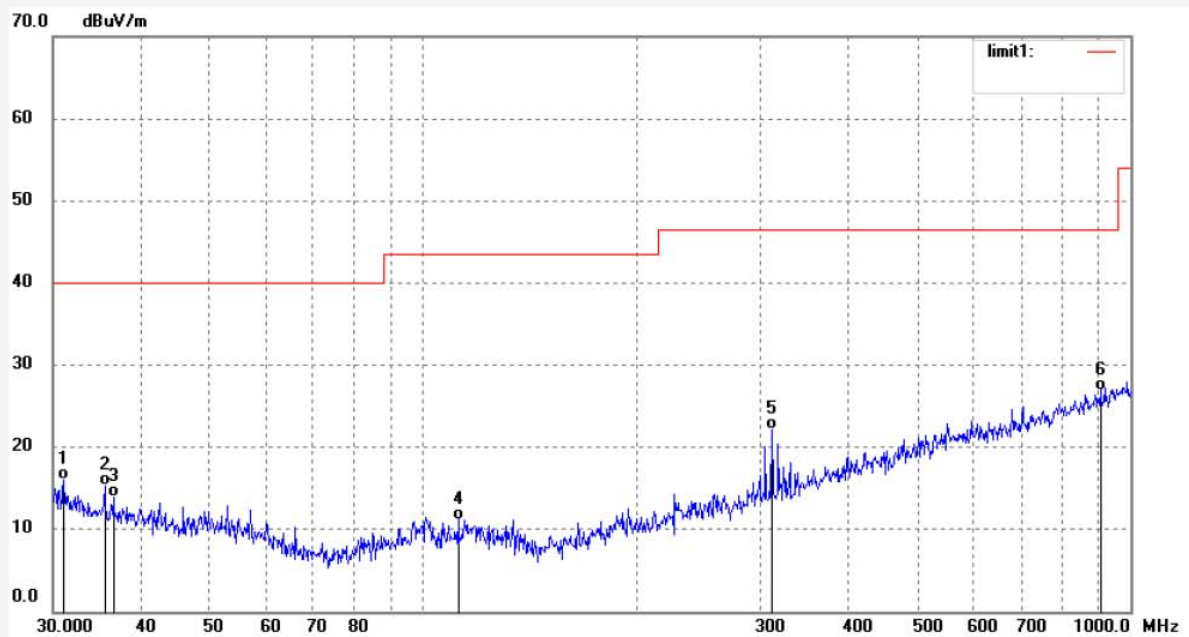

No.	Freq. (MHz)	Reading (dBuV/m)	Factor (dB)	Result (dBuV/m)	Limit (dBuV/m)	Margin (dB)	Detector	Height (cm)	Degree (deg.)	Remark
1	31.0705	26.28	-10.25	16.03	40.00	-23.97	QP	100	145	
2	35.4992	26.90	-11.53	15.37	40.00	-24.63	QP	100	92	
3	36.5091	25.67	-11.75	13.92	40.00	-26.08	QP	100	126	
4	112.1304	25.78	-14.58	11.20	43.50	-32.30	QP	100	163	
5	311.0867	32.13	-9.99	22.14	46.50	-24.36	QP	100	62	
6	906.4823	26.62	0.33	26.95	46.50	-19.55	QP	100	126	

Above 1GHz

ACCURATE TECHNOLOGY CO., LTD.

 F1,Bldg,A,Changyuan New Material Port Keyuan Rd,
 Science & Industry Park,Nanshan Shenzhen,P.R.China

Site: 1# Chamber

Tel:+86-0755-26503290

Fax:+86-0755-26503396

 Job No.: emc #93
 Standard: FCC PK
 Test item: Radiation Test
 Temp.(C)/Hum.(%) 25 C / 55 %
 EUT: Bluemini Bluetooth Dongle
 Mode: TX2402MHz
 Model: Bluemini
 Manufacturer: Head-Direct(Kunshan)Co.,LTD

 Polarization: Vertical
 Power Source: DC 3.7V
 Date: 20/03/20/
 Time: 15/51/36
 Engineer Signature:
 Distance: 3m

Note: Report NO.:ATE20200222

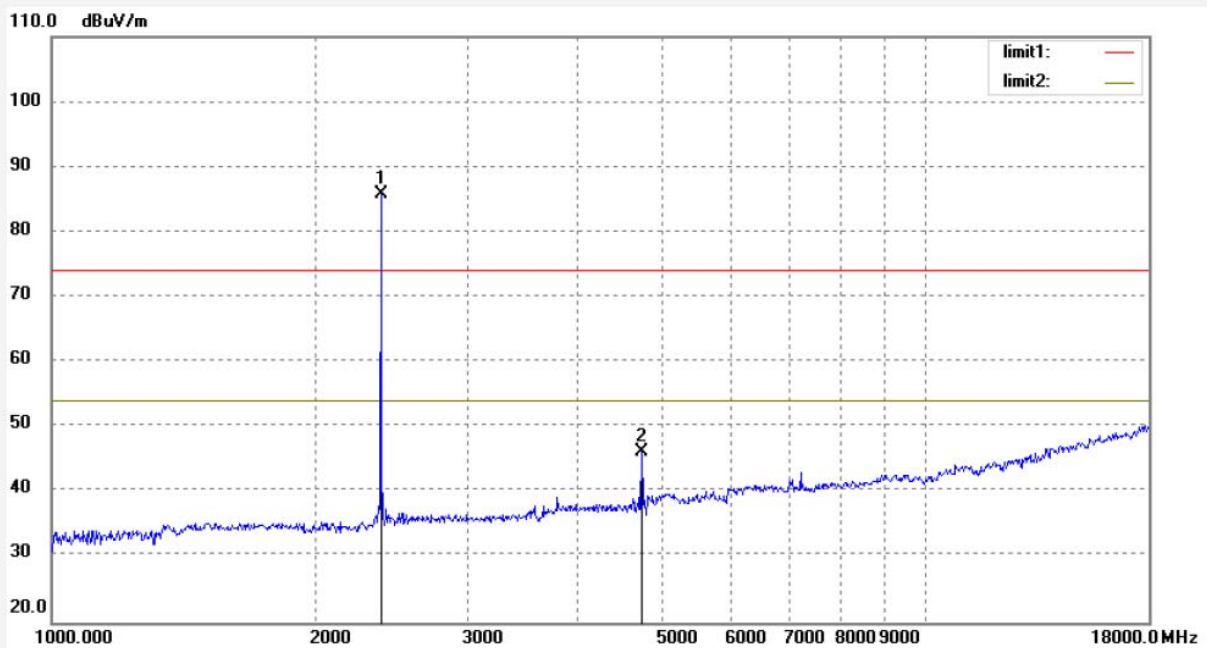

No.	Freq. (MHz)	Reading (dBuV/m)	Factor (dB)	Result (dBuV/m)	Limit (dBuV/m)	Margin (dB)	Detector	Height (cm)	Degree (deg.)	Remark
1	2402.000	92.10	-6.37	85.73			peak	150	96	
2	4804.000	45.61	0.70	46.31	74.00	-27.69	peak	150	211	



ACCURATE TECHNOLOGY CO., LTD.

F1,Bldg,A,Changyuan New Material Port Keyuan Rd,
Science & Industry Park,Nanshan Shenzhen,P.R.China

Site: 1# Chamber

Tel:+86-0755-26503290

Fax:+86-0755-26503396

Job No.: emc #92

Standard: FCC PK

Test item: Radiation Test

Temp.(C)/Hum.(%) 25 C / 55 %

EUT: Bluemini Bluetooth Dongle

Mode: TX2402MHz

Model: Bluemini

Manufacturer: Head-Direct(Kunshan)Co.,LTD

Polarization: Horizontal

Power Source: DC 3.7V

Date: 20/03/20/

Time: 15/51/25

Engineer Signature:

Distance: 3m

Note: Report NO.:ATE20200222

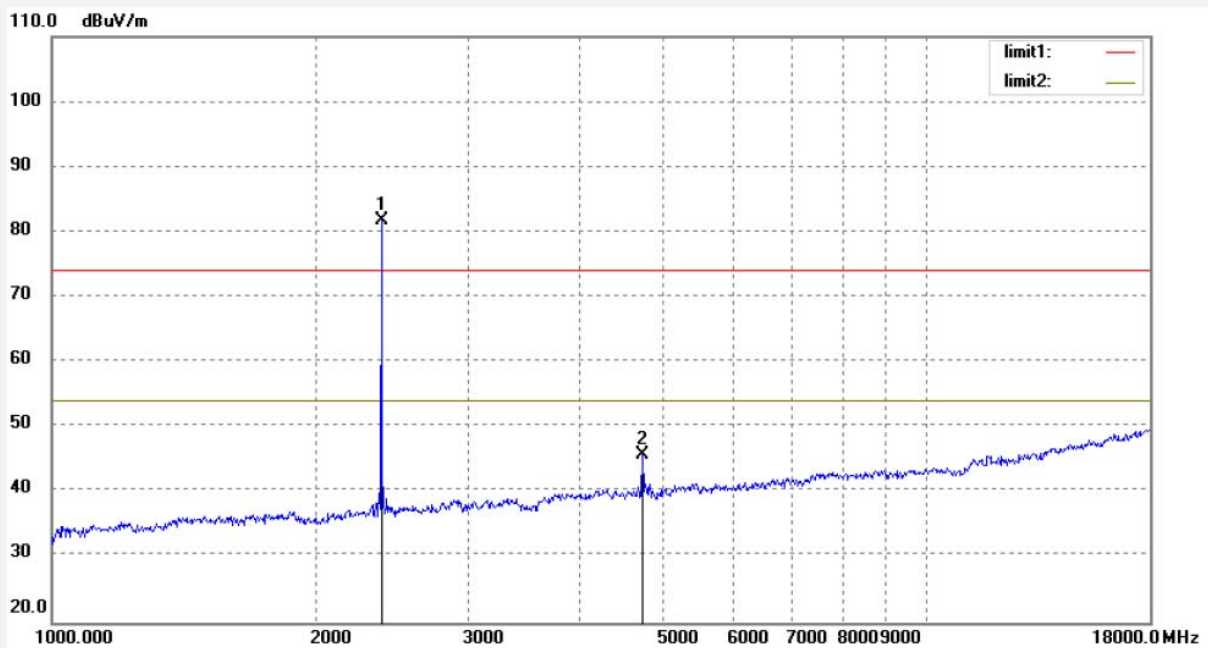

No.	Freq. (MHz)	Reading (dBuV/m)	Factor (dB)	Result (dBuV/m)	Limit (dBuV/m)	Margin (dB)	Detector	Height (cm)	Degree (deg.)	Remark
1	2402.000	88.10	-6.37	81.73			peak	200	321	
2	4804.000	45.11	0.70	45.81	74.00	-28.19	peak	200	106	

Job No.: emc #91

Standard: FCC PK

Test item: Radiation Test

Temp.(C)/Hum.(%) 25 C / 55 %

EUT: Bluemini Bluetooth Dongle

Mode: TX2440MHz

Model: Bluemini

Manufacturer: Head-Direct(Kunshan)Co.,LTD

Polarization: Horizontal

Power Source: DC 3.7V

Date: 20/03/20/

Time: 15/50/18

Engineer Signature:

Distance: 3m

Note: Report NO.:ATE20200222

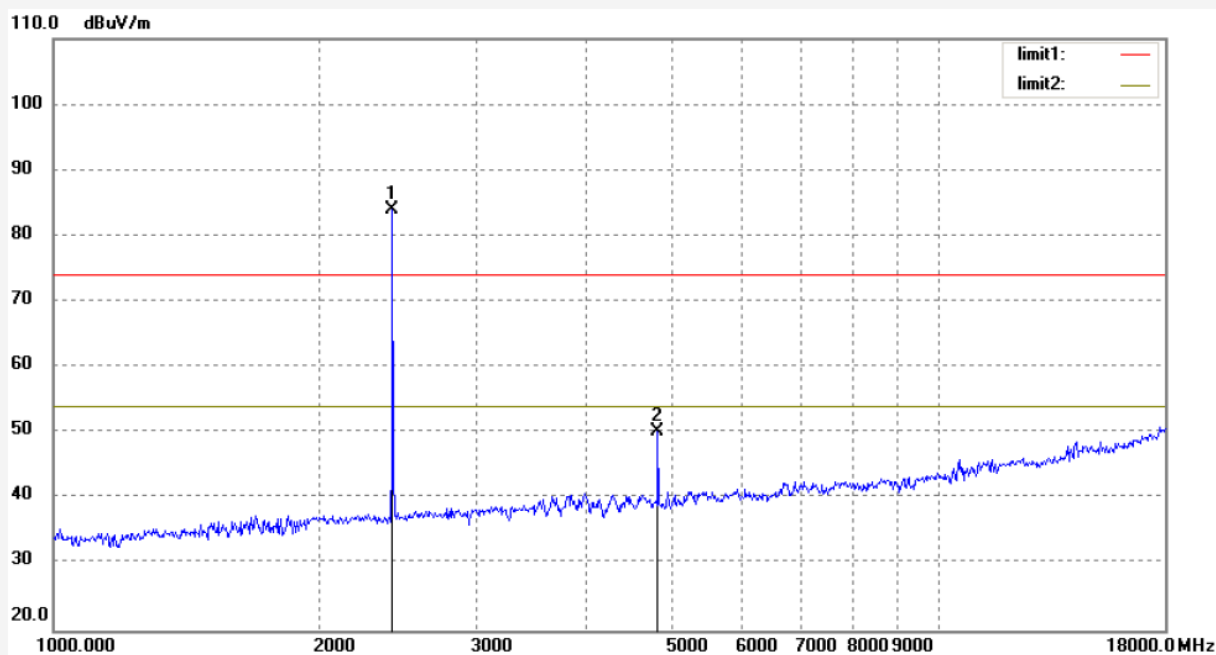

No.	Freq. (MHz)	Reading (dBuV/m)	Factor (dB)	Result (dBuV/m)	Limit (dBuV/m)	Margin (dB)	Detector	Height (cm)	Degree (deg.)	Remark
1	2440.000	90.17	-6.20	83.97			peak	200	41	
2	4880.000	49.26	1.07	50.33	74.00	-23.67	peak	200	108	

Job No.: emc #90

Standard: FCC PK

Test item: Radiation Test

Temp.(C)/Hum.(%) 25 C / 55 %

EUT: Bluemini Bluetooth Dongle

Mode: TX2440MHz

Model: Bluemini

Manufacturer: Head-Direct(Kunshan)Co.,LTD

Polarization: Vertical

Power Source: DC 3.7V

Date: 20/03/20/

Time: 15/50/12

Engineer Signature:

Distance: 3m

Note: Report NO.:ATE20200222

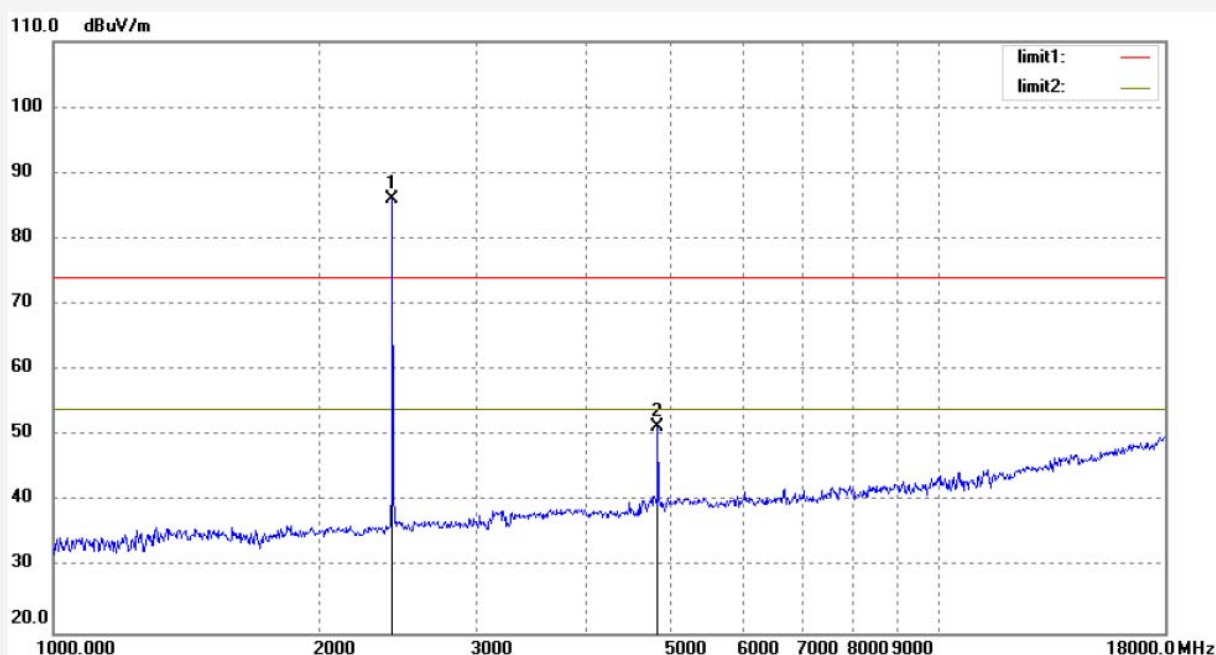

No.	Freq. (MHz)	Reading (dBuV/m)	Factor (dB)	Result (dBuV/m)	Limit (dBuV/m)	Margin (dB)	Detector	Height (cm)	Degree (deg.)	Remark
1	2440.000	92.17	-6.20	85.97			peak	150	52	
2	4880.000	50.26	1.07	51.33	74.00	-22.67	peak	150	104	



ACCURATE TECHNOLOGY CO., LTD.

F1,Bldg,A,Changyuan New Material Port Keyuan Rd,
Science & Industry Park,Nanshan Shenzhen,P.R.China

Site: 1# Chamber
Tel:+86-0755-26503290
Fax:+86-0755-26503396

Job No.: emc #89

Standard: FCC PK

Test item: Radiation Test

Temp.(C)/Hum.(%) 25 C / 55 %

EUT: Bluemini Bluetooth Dongle

Mode: TX2480MHz

Model: Bluemini

Manufacturer: Head-Direct(Kunshan)Co.,LTD

Polarization: Vertical

Power Source: DC 3.7V

Date: 20/03/20/

Time: 15/49/18

Engineer Signature:

Distance: 3m

Note: Report NO.:ATE20200222

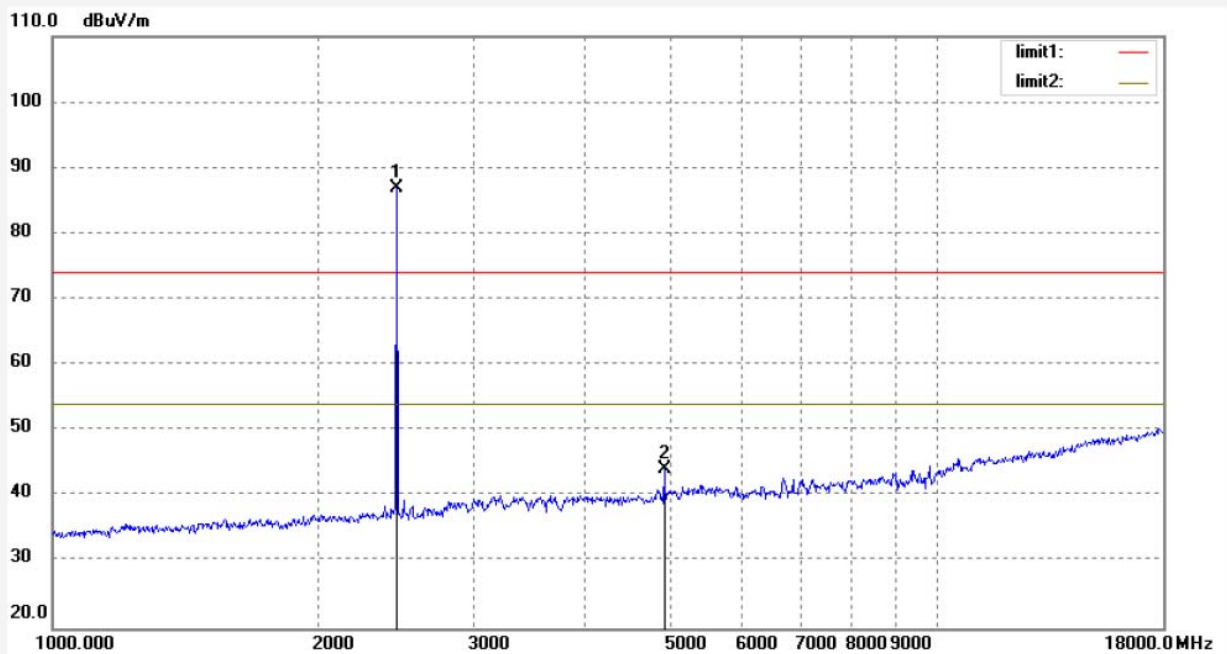

No.	Freq. (MHz)	Reading (dBuV/m)	Factor (dB)	Result (dBuV/m)	Limit (dBuV/m)	Margin (dB)	Detector	Height (cm)	Degree (deg.)	Remark
1	2480.000	92.96	-6.04	86.92			peak	150	63	
2	4960.000	42.59	1.50	44.09	74.00	-29.91	peak	150	106	



ACCURATE TECHNOLOGY CO., LTD.

F1,Bldg,A,Changyuan New Material Port Keyuan Rd,
Science & Industry Park,Nanshan Shenzhen,P.R.China

Site: 1# Chamber
Tel:+86-0755-26503290
Fax:+86-0755-26503396

Job No.: emc #88	Polarization: Horizontal
Standard: FCC PK	Power Source: DC 3.7V
Test item: Radiation Test	Date: 20/03/20/
Temp.(C)/Hum.(%) 25 C / 55 %	Time: 15/49/04
EUT: Bluemini Bluetooth Dongle	Engineer Signature:
Mode: TX2480MHz	Distance: 3m
Model: Bluemini	
Manufacturer: Head-Direct(Kunshan)Co.,LTD	

Note: Report NO.:ATE20200222

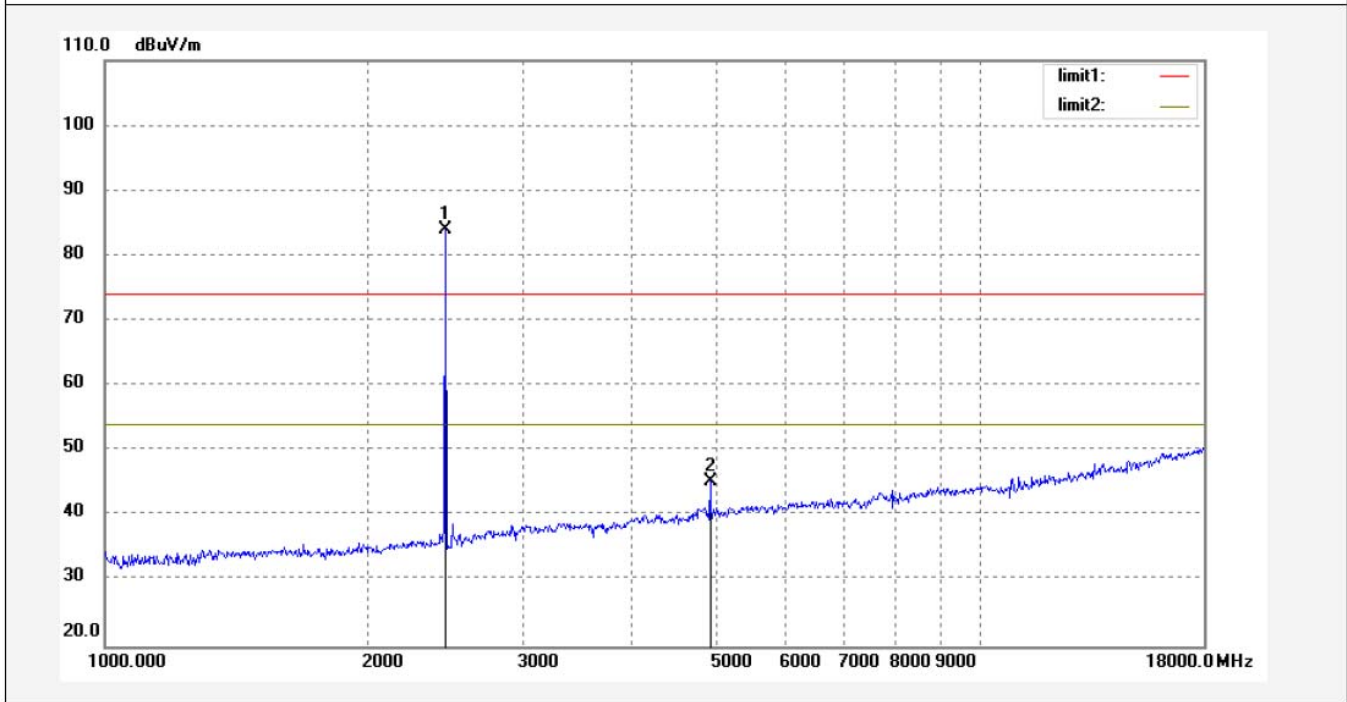

No.	Freq. (MHz)	Reading (dBuV/m)	Factor (dB)	Result (dBuV/m)	Limit (dBuV/m)	Margin (dB)	Detector	Height (cm)	Degree (deg.)	Remark
1	2480.000	89.96	-6.04	83.92			peak	200	216	
2	4960.000	43.90	1.50	45.40	74.00	-28.60	peak	200	92	

10. POWER LINE CONDUCTED EMISSION TEST

10.1. Block Diagram of Test Setup

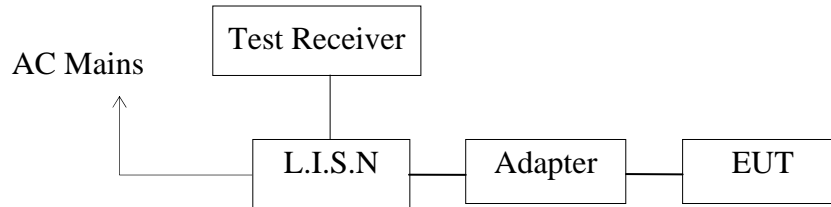

10.2. Test System Setup

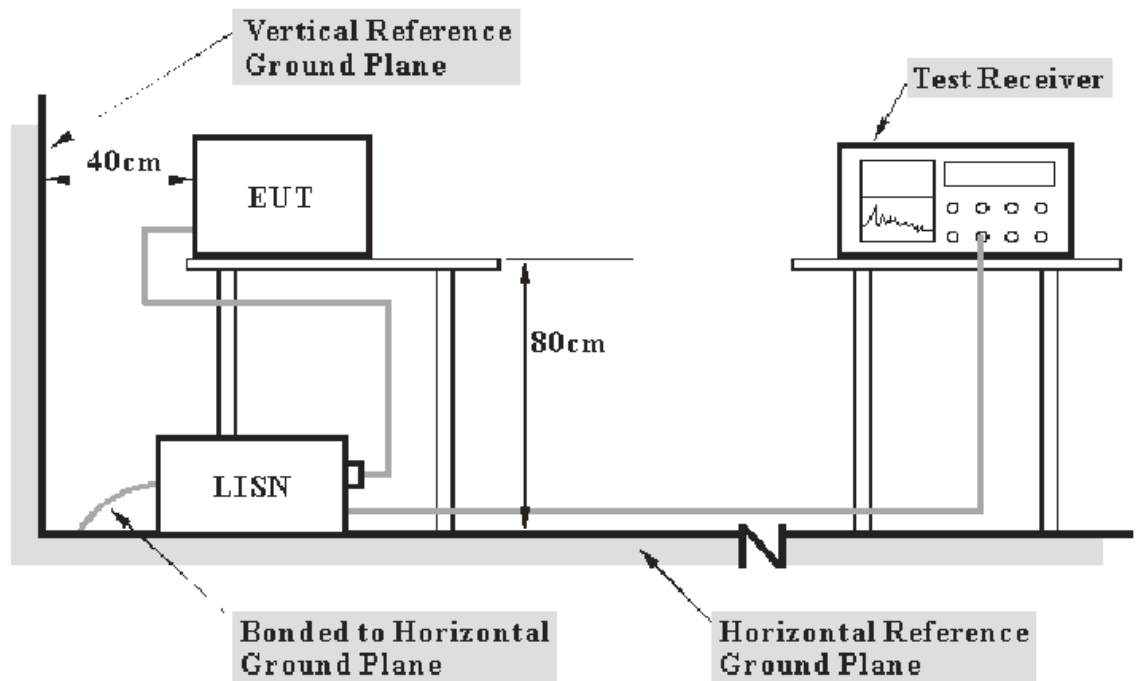

- Note:**
1. Support units were connected to second LISN.
 2. Both of LISNs (AMN) 80 cm from EUT and at the least 80 cm from other units and other metal planes support units.

10.3. Test Limits

Frequency (MHz)	Limit dB(μV)	
	Quasi-peak Level	Average Level
0.15 - 0.50	66.0 – 56.0 *	56.0 – 46.0 *
0.50 - 5.00	56.0	46.0
5.00 - 30.00	60.0	50.0

NOTE1: The lower limit shall apply at the transition frequencies.
 NOTE2: The limit decreases linearly with the logarithm of the frequency in the range 0.15MHz to 0.50MHz.

10.4. Configuration of EUT on Test

The equipments are installed on Power Line Conducted Emission Measurement to meet the commission requirement and operating regulations in a manner, which tends to maximize its emission characteristics in a normal application.

10.5. Operating Condition of EUT

10.5.1. Setup the EUT and simulator as shown as Section 10.1.

10.5.2. Turn on the power of all equipment.

10.5.3. Let the EUT work in test mode and measure it.

10.6. Test Procedure

The EUT is put on the plane 0.8m high above the ground by insulating support and is connected to the power mains through a line impedance stabilization network (L.I.S.N.). This provides a 50ohm coupling impedance for the EUT system. Please refer the block diagram of the test setup and photographs. Both sides of AC lines are checked to find out the maximum conducted emission. In order to find the maximum emission levels, the relative positions of equipment and all of the interface cables shall be changed according to ANSI C63.10: 2013 on Conducted Emission Measurement.

The bandwidth of test receiver is set at 9kHz.

The frequency range from 150kHz to 30MHz is checked.

10.7.Data Sample

Frequency (MHz)	Transducer value (dB)	QuasiPeak Level (dBμV)	Average Level (dBμV)	QuasiPeak Limit (dBμV)	Average Limit (dBμV)	QuasiPeak Margin (dB)	Average Margin (dB)	Remark (Pass/Fail)
X.XX	10.5	51.1	34.2	56.0	46.0	4.9	11.8	Pass

Frequency(MHz) = Emission frequency in MHz

Transducer value(dB) = Insertion loss of LISN + Cable Loss

Level(dBμV) = Quasi-peak Reading/Average Reading + Transducer value

Limit (dBμV) = Limit stated in standard

Calculation Formula:

Margin = Limit (dBμV) - Level (dBμV)

10.8.Test Result

Pass.

The frequency range from 150kHz to 30MHz is checked.

Maximizing procedure was performed on the six (6) highest emissions of the EUT.

Emissions attenuated more than 20 dB below the permissible value are not reported.

All data was recorded in the Quasi-peak and average detection mode.

The spectral diagrams are attached as below.

ACCURATE TECHNOLOGY CO.,LTD

CONDUCTED EMISSION STANDARD FCC PART 15B

EUT: Bluemini Bluetooth Dongle M/N:Bluemini
 Manufacturer: Head-Direct (Kunshan) Co.,LTD
 Operating Condition: BT Communication
 Test Site: 1#Shielding Room
 Operator: Frank
 Test Specification: L 120V /60Hz
 Comment: Report NO.:ATE20200222
 Start of Test: 2020-3-20 / 14:59:44

SCAN TABLE: "V 150K-30MHZ fin"

Short Description: _SUB_STD_VTERM2 1.70
 Start Stop Step Detector Meas. IF Transducer
 Frequency Frequency Width Time Bandw.
 150.0 kHz 30.0 MHz 4.5 kHz QuasiPeak 1.0 s 9 kHz NSLK8126 2008
 Average

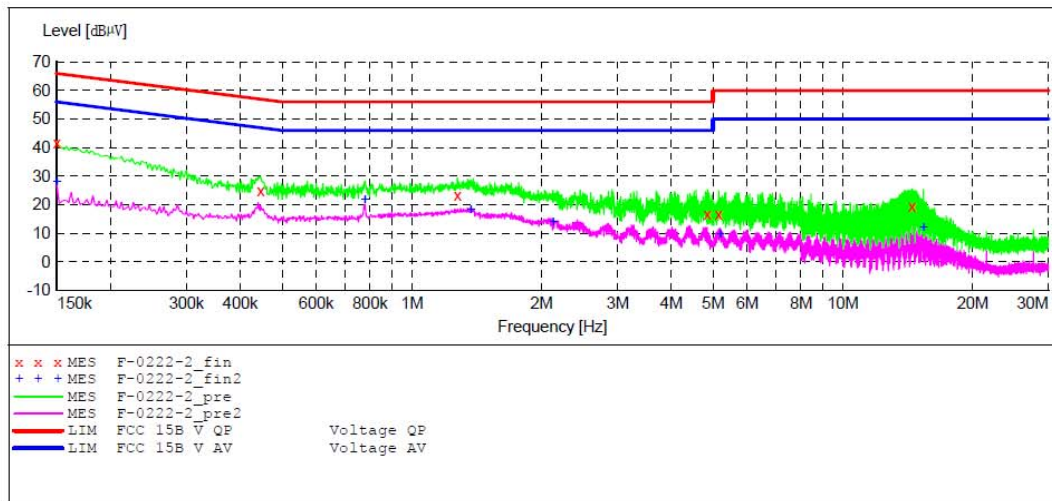

MEASUREMENT RESULT: "F-0222-2_fin"

2020-3-20 15:01

Frequency MHz	Level dBµV	Transd dB	Limit dBµV	Margin dB	Detector	Line	PE
0.150000	41.60	10.8	66	24.4	QP	L1	GND
0.446000	24.90	11.0	57	32.0	QP	L1	GND
1.276000	23.10	11.2	56	32.9	QP	L1	GND
4.855000	16.70	11.4	56	39.3	QP	L1	GND
5.155000	16.70	11.4	60	43.3	QP	L1	GND
14.490000	19.30	11.6	60	40.7	QP	L1	GND

MEASUREMENT RESULT: "F-0222-2_fin2"

2020-3-20 15:01

Frequency MHz	Level dBµV	Transd dB	Limit dBµV	Margin dB	Detector	Line	PE
0.150000	27.80	10.8	56	28.2	AV	L1	GND
0.778000	21.60	11.1	46	24.4	AV	L1	GND
1.370000	18.20	11.2	46	27.8	AV	L1	GND
2.130000	13.80	11.3	46	32.2	AV	L1	GND
5.190000	9.60	11.4	50	40.4	AV	L1	GND
15.395000	12.00	11.7	50	38.0	AV	L1	GND

ACCURATE TECHNOLOGY CO., LTD

CONDUCTED EMISSION STANDARD FCC PART 15B

EUT: Bluemini Bluetooth Dongle M/N: Bluemini
 Manufacturer: Head-Direct (Kunshan) Co., LTD
 Operating Condition: BT Communication
 Test Site: 1#Shielding Room
 Operator: Frank
 Test Specification: N 120V /60Hz
 Comment: Report NO.: ATE20200222
 Start of Test: 2020-3-20 / 14:57:08

SCAN TABLE: "V 150K-30MHz fin"

Short Description: _SUB_STD_VTERM2 1.70
 Start Stop Step Detector Meas. IF Transducer
 Frequency Frequency Width Time Bandw.
 150.0 kHz 30.0 MHz 4.5 kHz QuasiPeak 1.0 s 9 kHz NSLK8126 2008
 Average

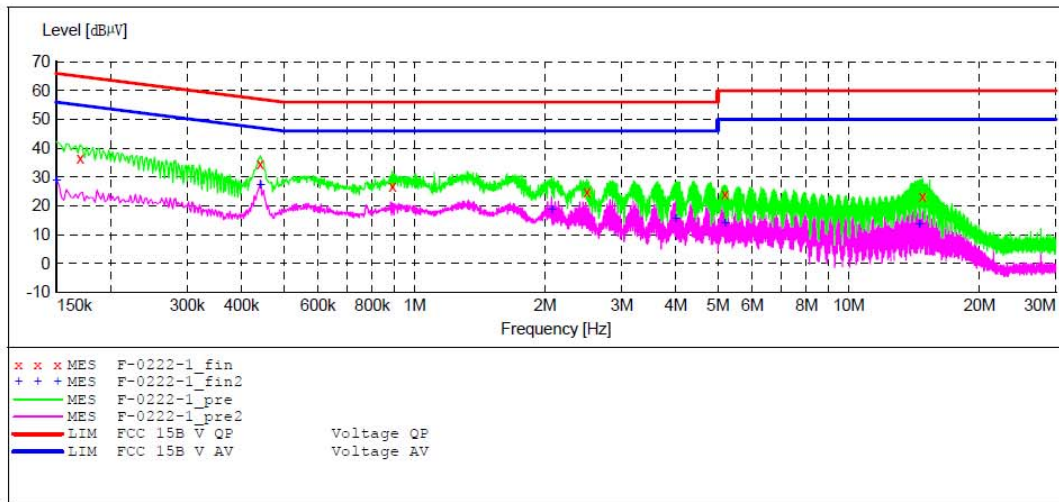

MEASUREMENT RESULT: "F-0222-1_fin"

2020-3-20 14:58

Frequency MHz	Level dBµV	Transd dB	Limit dBµV	Margin dB	Detector	Line	PE
0.170000	36.60	10.8	65	28.4	QP	N	GND
0.442000	34.60	11.0	57	22.4	QP	N	GND
0.890000	26.90	11.1	56	29.1	QP	N	GND
2.500000	24.80	11.3	56	31.2	QP	N	GND
5.195000	24.00	11.4	60	36.0	QP	N	GND
14.805000	23.30	11.6	60	36.7	QP	N	GND

MEASUREMENT RESULT: "F-0222-1_fin2"

2020-3-20 14:58

Frequency MHz	Level dBµV	Transd dB	Limit dBµV	Margin dB	Detector	Line	PE
0.150000	28.90	10.8	56	27.1	AV	N	GND
0.442000	27.30	11.0	47	19.7	AV	N	GND
2.070000	18.50	11.3	46	27.5	AV	N	GND
3.995000	15.60	11.4	46	30.4	AV	N	GND
5.195000	13.90	11.4	50	36.1	AV	N	GND
14.550000	13.70	11.6	50	36.3	AV	N	GND

11.ANTENNA REQUIREMENT

11.1.The Requirement

According to Section 15.203, an intentional radiator shall be designed to ensure that no antenna other than that furnished by the responsible party shall be used with the device.

11.2.Antenna Construction

Device is equipped with permanent attached antenna, which isn't displaced by other antenna. The Max Antenna gain of EUT is 3dBi. Therefore, the equipment complies with the antenna requirement of Section 15.203.

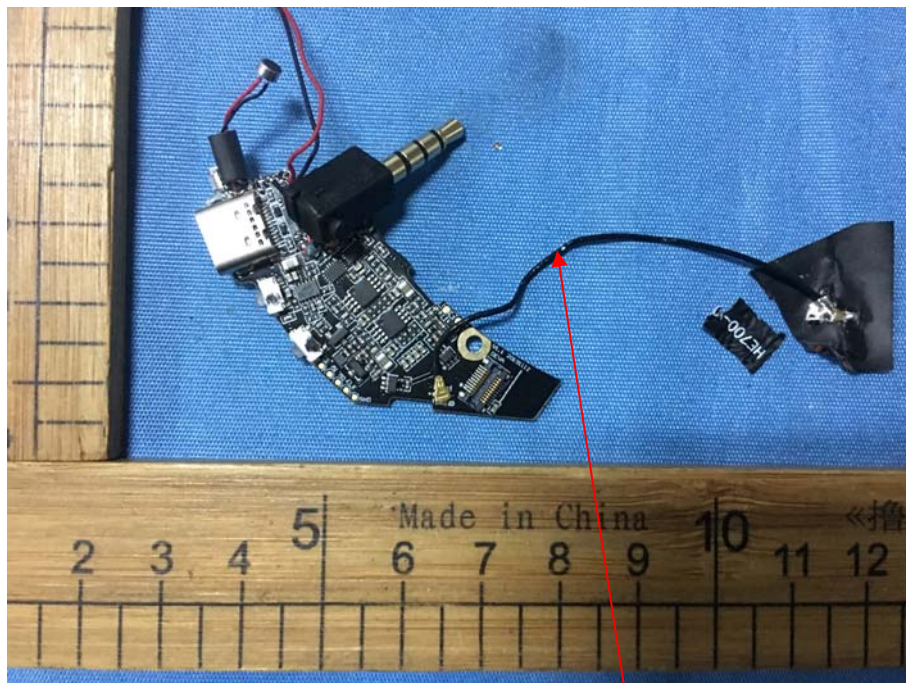

Antenna

***** End of Test Report *****