

Bluetooth Speaker

RS19

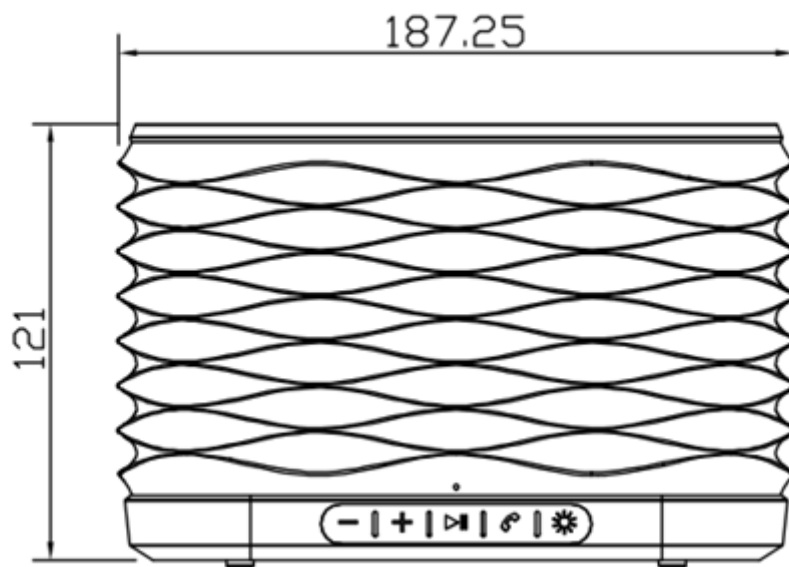

User Guide

***What is in the box***

- 1 X LED COLOR CHANGING Speaker
- 1 X Micro USB Cable
- 1 X Line in Cable
- 1 X User Manual

***Product Overview***

1. Aux

2. Charging indicator
3. Micro USB port
4. Power ON/OFF
5. Volume -/Previous Song
6. Volume +/Next Song
7. Play/Pause/Mute
8. Answer/Refuse/Redial
9. Lighting mode

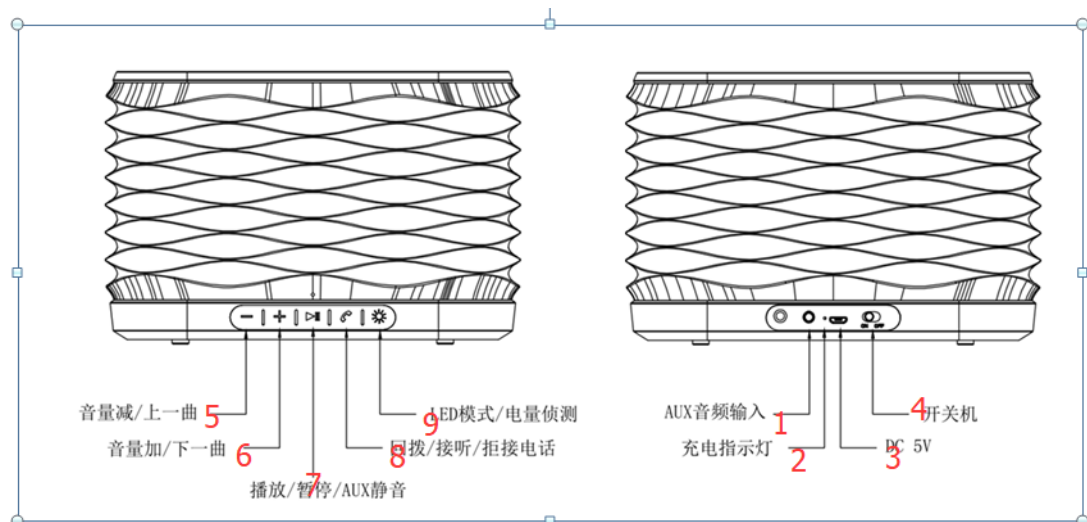

### **Charging the Bluetooth speaker**

Before first use, please charge the Bluetooth speaker.

Plug the provided charging cable into the speaker and an active computer USB port or a USB AC adapter that is plugged into an active wall outlet. The LED light is red color and will be die out after full charged.

Low Battery Warning: The speaker will sounds "Battery level very low", and it will turn off when the voltage lower than 3.2v.

Remark: If not using the speaker for a long period of time, keep the internal battery charged (charge once every 3 months). This will extend the life of your battery.

### **Bluetooth Instruction (Note: The Bluetooth code is B105, pair code: 0000)**

Make sure the Bluetooth function is available on your cell phone. Specific pairing procedures will be different depending on different cell phone. For detailed information, please refer to your cell phone User Guide.

- If no device connection is made within 10 minutes of the Speaker being switched on, the Speaker will automatically switch to power off to save power.
- After a successful pairing, devices will memorize each other. It will be connected automatically after turn on.

1. Keep the distance between the cell phone and the Speaker within 10m (for pairing)

only).

2. Turn on the Speaker.
3. The tone prompt will sound and the LED light will be blue for one second, then blue and red color alternative. The unit enter into pairing mode.
4. Activate the Bluetooth function of the cell phone to search for the Bluetooth devices. After finishing the search, select "B105" in the device list displayed.
5. The Bluetooth speaker is ready for use.
6. During the time, if want use another cell phone to connect the speaker, Long press  button to disconnect current cell phone. Then open the Bluetooth and connect with the speaker in another cell phone

### ***Speaker Controls***

**ON/OFF** Turn ON/OFF

**VOLUME** (during a call or when listening to music)

**Volume +:** Press and hold  Button.

**Volume -:** Press and hold  Button.

**MUSIC**(Note: The music function Control only works with Bluetooth devices that support the A2DP profile.)

**Go to next song:** Short press  Button

**Go to previous song:** Short Press  Button

### **PLAY/PAUSE**

Press  button to play/pause during play music.

### **ANSWER/REFUSE/REDIA THE CALL**

Press  button to answer the call, press it again to hang up.







Long press  button to refuse the call.

Double press  button to call back the last number.

To hang up the call press it again.

Remark: Please face on the Microphone hole to answer the call, to avoid the poor call quality.

### **LIGHTING MODE** (note: The lighting mode can be used during playing music.)

- Mode 1: Press , breathing light from the right to left
- Mode 2: Press , Seven kinds of monochromatic light automatic switch
- Mode 3: Press , Save the current color
- Mode 4: Press , Slowly breathing light with music
- Mode 5: Press , Mixed color light automatic switch
- Mode 6: Press , Turn off the lights

### **Battery Status**

During Power ON mode, Long press  2 seconds, voice prompt tell battery status

When the battery voltage is 3.8~4.2v, it sound "Battery level excellent" with three layers of a green light

When the battery voltage is 3.6~3.8v, it sound "Battery level good" with three layers of a green light

When the battery voltage is 3.4~3.6v, it sound "Battery level low" with one layer of a green light

When the battery voltage is 3.2~3.4v, it sound "Battery level very low" with one layer of a red light

### **AUX MODE**

Use the 3.5mm audio cable (included) to connect the Speaker to an audio source (MP3/MP4, mobile phone, computer). A tone will sound. The speaker will play the music from the audio source.

### **Specifications**

Function: Bluetooth, Hands free, LED light, Line in

Bluetooth version:5.0

Power output:10W 4Ω

Speaker:D45mm\*2(100HZ-20KHZ)

Lithium -ion battery: 4000mAh

Dimension: 187\*121\*73.6MM

Single weight: 697g

SNR: 90±3dB

Charging Time: 4hours

Play Time: 8hours (max volume)

## **FCC Statement**

This device complies with Part 15 of the FCC Rules. Operation is subject to the following two conditions: (1) this device may not cause harmful interference, and (2) this device must accept any interference received, including interference that may cause undesired operation.

Changes or modifications to this unit not expressly approved by the party responsible for compliance could void the user's authority to operate the equipment.

NOTE: This equipment has been tested and found to comply with the limits for a Class B digital device, pursuant to Part 15 of the FCC Rules. These limits are designed to provide reasonable protection against harmful interference in a residential installation. This equipment generates, uses and can radiate radio frequency energy and, if not installed and used in accordance with the instructions, may cause harmful interference to radio communications. However, there is no guarantee that interference will not occur in a particular installation. If this equipment does cause harmful interference to radio or television reception, which can be determined by turning the equipment off and on, the user is encouraged to try to correct the interference by one or more of the following measures:

- Reorient or relocate the receiving antenna.
- Increase the separation between the equipment and receiver.
- Connect the equipment into an outlet on a circuit different from that to which the receiver is connected.
- Consult the dealer or an experienced radio/TV technician for help.

This device and its antenna(s) must not be co-located or operation in conjunction with any other antenna or transmitter.

The device has been evaluated to meet general RF exposure requirement. in portable exposure condition without restriction.