

TEST REPORT

Report No.: BCTC2209158799E

Applicant: Shenzhen Wellturn Technology Co., Ltd

Product Name: remote dog training collar

Model/Type Ref.: T330

Tested Date: 2022-09-06 to 2022-11-25

Issued Date: 2022-11-25

Shenzhen BCTC Testing Co., Ltd.



FCC ID:2ATOX-T330

Product Name: remote dog training collar
Trademark: N/A
Model/Type Ref.: T330
T331, T332, T333
Prepared For: Shenzhen Wellturn Technology Co., Ltd
Address: A603-604, 6/F, Tower A, Donglian Building, Chuangye Rd, No.23 Baoan District, Shenzhen City, China
Manufacturer: Shenzhen Wellturn Technology Co., Ltd
Address: A603-604, 6/F, Tower A, Donglian Building, Chuangye Rd, No.23 Baoan District, Shenzhen City, China
Prepared By: Shenzhen BCTC Testing Co., Ltd.
Address: 1-2/F., Building B, Pengzhou Industrial Park, No.158, Fuyuan 1st Road, Zhancheng, Fuhai Subdistrict, Bao'an District, Shenzhen, Guangdong, China
Sample Received Date: 2022-09-06
Sample tested Date: 2022-09-06 to 2022-11-25
Issue Date: 2022-11-25
Report No.: BCTC2209158799E
Test Standards: FCC Part15.231
ANSI C63.10-2013
Test Results: PASS

Tested by:



Jeff.Fu/Project Handler

Approved by:



Zero Zhou/Reviewer

The test report is effective only with both signature and specialized stamp. This result(s) shown in this report refer only to the sample(s) tested. Without written approval of Shenzhen BCTC Testing Co., Ltd, this report can't be reproduced except in full. The tested sample(s) and the sample information are provided by the client.

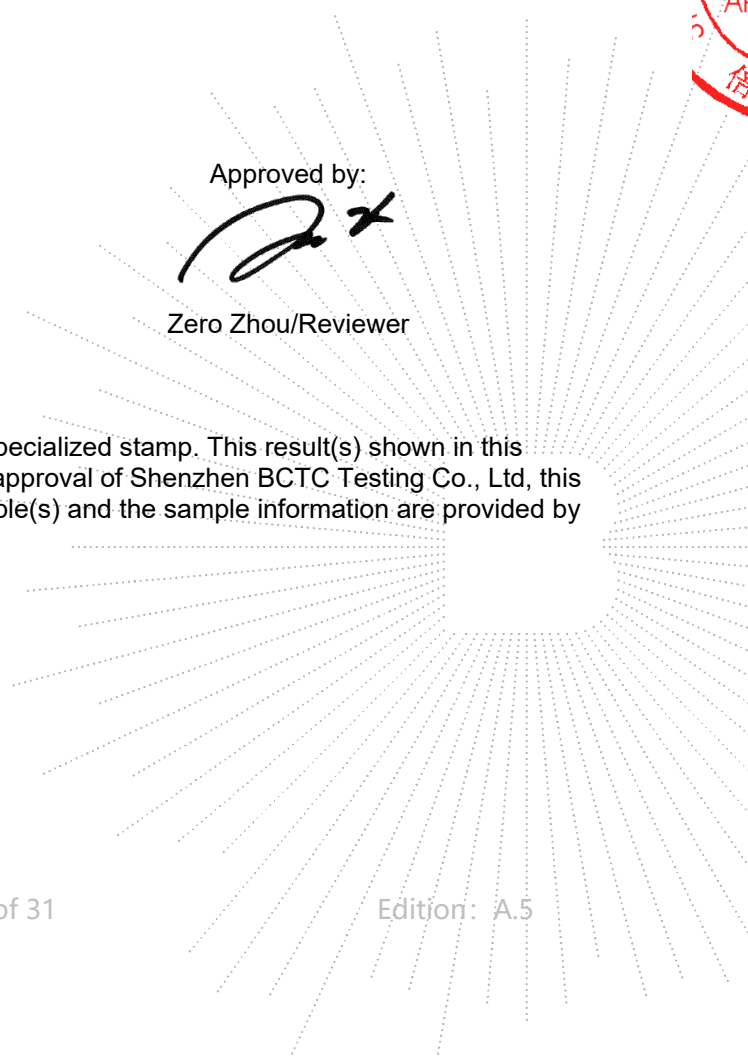

Table Of Content

| Test Report Declaration | Page |
|--|------|
| 1. Version | 4 |
| 2. Test Summary | 5 |
| 3. Measurement Uncertainty | 6 |
| 4. Product Information And Test Setup | 7 |
| 4.1 Product Information..... | 7 |
| 4.2 Test Setup Configuration | 7 |
| 4.3 Support Equipment | 7 |
| 4.4 Channel List | 8 |
| 4.5 Test Mode | 8 |
| 5. Test Facility And Test Instrument Used..... | 9 |
| 5.1 Test Facility..... | 9 |
| 5.2 Test Instrument Used..... | 9 |
| 6. Conducted Emissions..... | 11 |
| 6.1 Block Diagram Of Test Setup..... | 11 |
| 6.2 Limit | 11 |
| 6.3 Test Procedure | 11 |
| 6.4 EUT Operating Conditions | 11 |
| 6.5 Test Result..... | 12 |
| 7. Radiated Emissions..... | 14 |
| 7.1 Block Diagram Of Test Setup..... | 14 |
| 7.2 Limit | 15 |
| 7.3 Test Procedure | 16 |
| 7.4 EUT Operating Conditions | 17 |
| 7.5 Test Result..... | 17 |
| 8. Bandwidth Test..... | 21 |
| 8.1 Block Diagram Of Test Setup..... | 21 |
| 8.2 Limit | 21 |
| 8.3 Test Procedure | 21 |
| 8.4 EUT Operating Conditions | 21 |
| 8.5 Test Result..... | 22 |
| 9. Calculation Of Average Factor | 23 |
| 10. Dwell Time..... | 25 |
| 10.1 Block Diagram Of Test Setup..... | 25 |
| 10.2 Limit | 25 |
| 10.3 Test Procedure | 25 |
| 10.4 Test Result..... | 26 |
| 11. Antenna Requirement | 27 |
| 11.1 Standard Requirement..... | 27 |
| 11.2 EUT Antenna | 27 |
| 12. EUT Photographs..... | 28 |
| 13. EUT Test Setup Photographs..... | 29 |

(Note: N/A Means Not Applicable)

 BCTC
 3C
 PPR
 检测

1. Version

| Report No. | Issue Date | Description | Approved |
|-----------------|------------|-------------|----------|
| BCTC2209158799E | 2022-11-25 | Original | Valid |
| | | | |

TEC
TC
OVER
檢

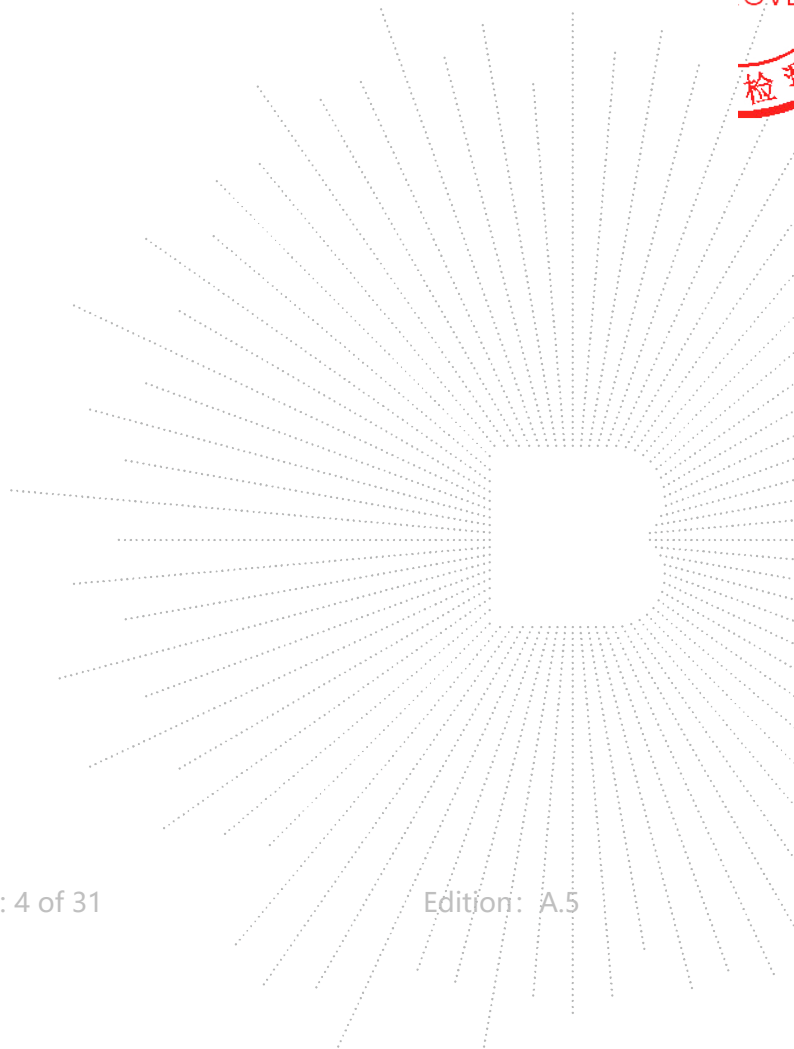

2. Test Summary

The Product has been tested according to the following specifications:

| No. | Test Parameter | Clause No | Results |
|-----|--|-----------------|---------|
| 1 | Conducted Emission | §15.207 | PASS |
| 2 | Fundamental & Radiated Spurious Emission Measurement | 15.209, 15.231b | PASS |
| 3 | Occupy Bandwidth | 15.231c | PASS |
| 4 | Dwell time | 15.231a | PASS |
| 5 | Antenna Requirement | 15.203 | PASS |

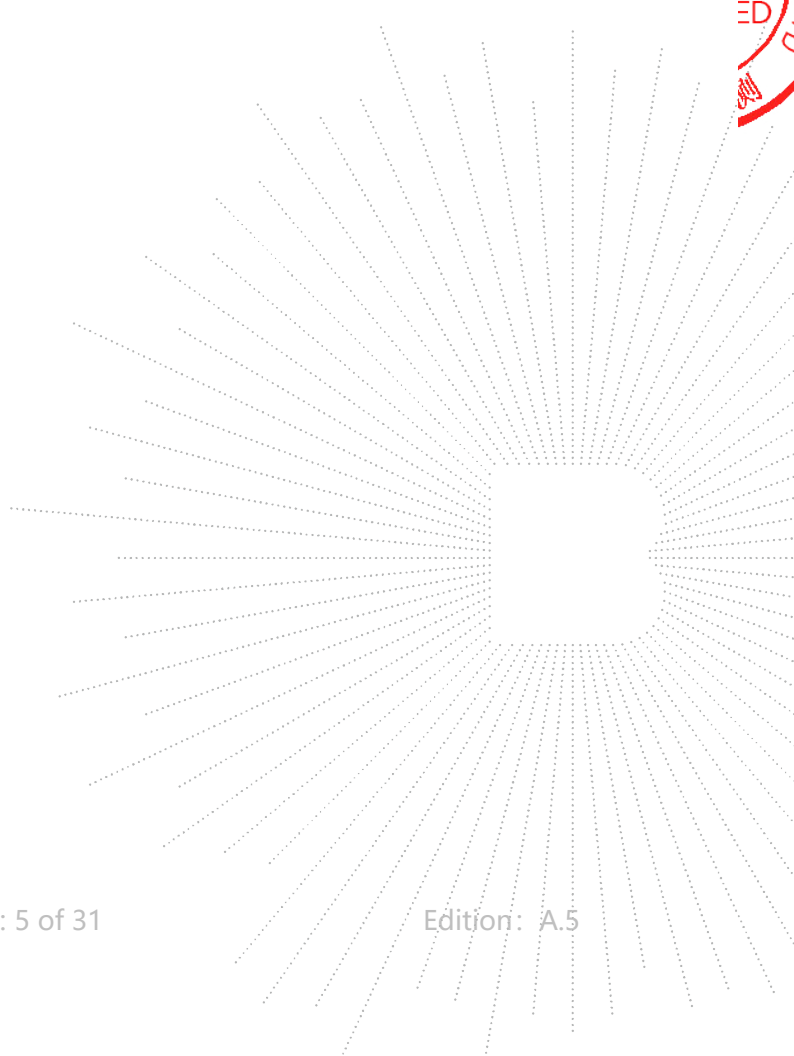

3. Measurement Uncertainty

Where relevant, the following measurement uncertainty levels have been estimated for tests performed on the Product as specified in CISPR 16-4-2. This uncertainty represents an expanded uncertainty expressed at approximately the 95% confidence level using a coverage factor of k=2.

| No. | Item | Uncertainty |
|-----|--|-------------|
| 1 | 3m chamber Radiated spurious emission(9kHz-30MHz) | U=3.7dB |
| 2 | 3m chamber Radiated spurious emission(30MHz-1GHz) | U=4.3dB |
| 3 | 3m chamber Radiated spurious emission(1GHz-18GHz) | U=4.5dB |
| 4 | 3m chamber Radiated spurious emission(18GHz-40GHz) | U=3.34dB |
| 5 | Conducted Emission(150kHz-30MHz) | U=3.20dB |
| 6 | Conducted Adjacent channel power | U=1.38dB |
| 7 | Conducted output power uncertainty Above 1G | U=1.576dB |
| 8 | Conducted output power uncertainty below 1G | U=1.28dB |
| 9 | humidity uncertainty | U=5.3% |
| 10 | Temperature uncertainty | U=0.59°C |

 CO.LTD

4. Product Information And Test Setup

4.1 Product Information

| | |
|-----------------------|--|
| Model/Type Ref.: | T330 T331, T332, T333 |
| Model differences: | All the model are the same circuit and RF module, except model names. |
| Hardware Version: | N/A |
| Software Version: | N/A |
| Operation Frequency: | 433.92 MHz |
| Type of Modulation: | ASK |
| Number Of Channel | 1CH |
| Antenna installation: | Spring antenna |
| Antenna Gain: | 0dBi |
| Ratings: | TX: DC 5V From Adapter, DC3.7V From Battery RX: DC 5V From Adapter, DC3.7V From Battery |

4.2 Test Setup Configuration

See test photographs attached in *EUT TEST SETUP PHOTOGRAPHS* for the actual connections between Product and support equipment.

Conducted Emission:

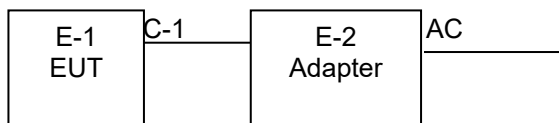

Radiated Spurious Emission

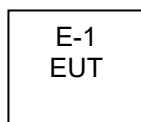

4.3 Support Equipment

| No. | Device Type | Brand | Model | Series No. | Note |
|-----|----------------------------|-------|---------|------------|-----------|
| E-1 | remote dog training collar | N/A | T330 | N/A | EUT |
| E-2 | Adapter | N/A | BCTC001 | N/A | Auxiliary |

| Item | Shielded Type | Ferrite Core | Length | Note |
|------|---------------|--------------|--------|----------------------|
| C-1 | NO | NO | 0.5M | USB cable unshielded |

Notes:

- All the equipment/cables were placed in the worst-case configuration to maximize the emission during the test.
- Grounding was established in accordance with the manufacturer's requirements and conditions for the intended use.

4.4 Channel List

| CH | Frequency (MHz) |
|----|-----------------|
| 1 | 433.92 |

4.5 Test Mode

To investigate the maximum EMI emission characteristics generated from EUT, the test system was pre-scanning tested based on the consideration of following EUT operation mode or test configuration mode which possibly have effect on EMI emission level. Each of these EUT operation mode(s) or test configuration mode(s) mentioned above was evaluated respectively.

| Final Test Mode | Description |
|-----------------|-------------|
| Mode 1 | Charging |
| Mode 2 | TX |

Note:

- (1) The measurements are performed at the highest, middle, lowest available channels.
- (2) Fully-charged battery is used during the test

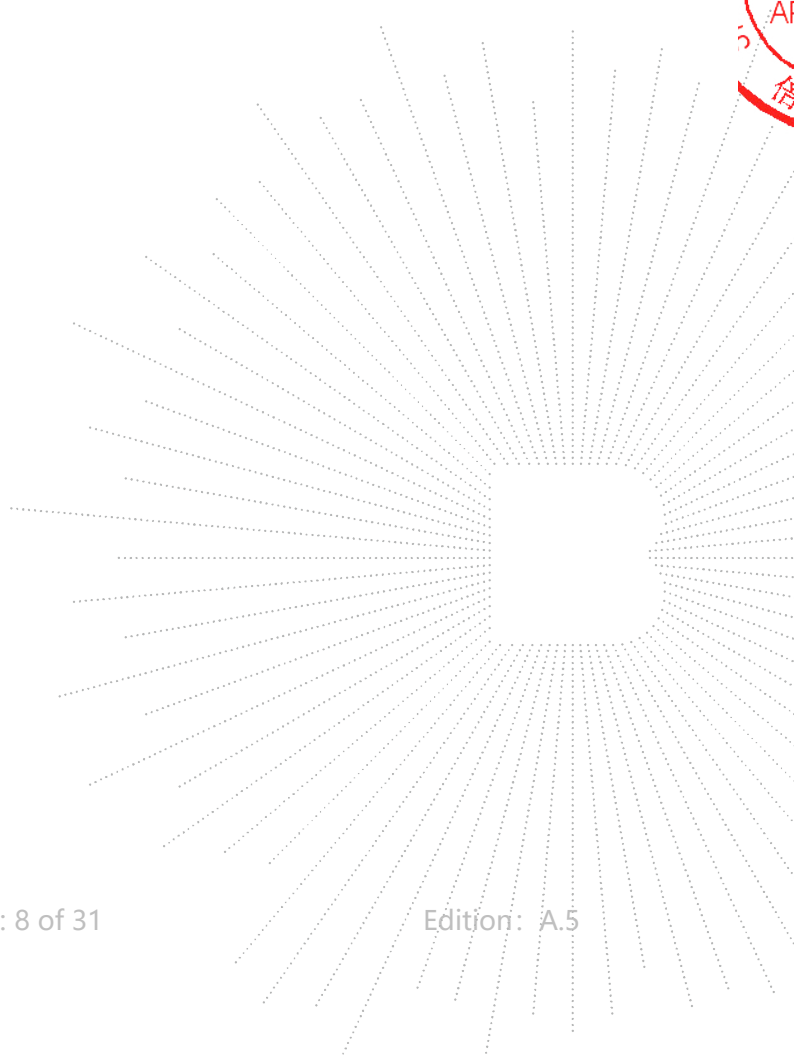

5. Test Facility And Test Instrument Used

5.1 Test Facility

All measurement facilities used to collect the measurement data are located at Shenzhen BCTC Testing Co., Ltd. Address: 1-2/F., Building B, Pengzhou Industrial Park, No.158, Fuyuan 1st Road, Zhancheng, Fuhai Subdistrict, Bao'an District, Shenzhen, Guangdong, China. The site and apparatus are constructed in conformance with the requirements of ANSI C63.4 and CISPR 16-1-1 other equivalent standards.

FCC Test Firm Registration Number: 712850

IC Registered No.: 23583

FCC Designation No.: CN1212

5.2 Test Instrument Used

| Conducted Emissions Test | | | | | |
|--------------------------|--------------|-----------------|----------------|--------------|--------------|
| Equipment | Manufacturer | Model# | Serial# | Last Cal. | Next Cal. |
| Receiver | R&S | ESR3 | 102075 | May 24, 2022 | May 23, 2023 |
| LISN | R&S | ENV216 | 101375 | May 24, 2022 | May 23, 2023 |
| Software | Frad | EZ-EMC | EMC-CON 3A1 | \ | \ |
| Attenuator | \ | 10dB DC-6GHz | 1650 | May 24, 2022 | May 23, 2023 |

| RF Conducted Test | | | | | |
|-------------------------------------|--------------|--------|------------|--------------|--------------|
| Equipment | Manufacturer | Model# | Serial# | Last Cal. | Next Cal. |
| Power Metter | Keysight | E4419 | \ | May 24, 2022 | May 23, 2023 |
| Power Sensor (AV) | Keysight | E9300A | \ | May 24, 2022 | May 23, 2023 |
| Signal Analyzer20kHz- 26.5GHz | Keysight | N9020A | MY49100060 | May 24, 2022 | May 23, 2023 |
| Spectrum Analyzer9kHz- 40GHz | R&S | FSP40 | \ | May 24, 2022 | May 23, 2023 |

TC
3C
PPR
测

| Radiated Emissions Test (966 Chamber01) | | | | | |
|---|--------------|----------------------|------------|---------------|---------------|
| Equipment | Manufacturer | Model# | Serial# | Last Cal. | Next Cal. |
| 966 chamber | ChengYu | 966 Room | 966 | Jun. 06. 2020 | Jun. 05, 2023 |
| Receiver | R&S | ESR3 | 102075 | May 24, 2022 | May 23, 2023 |
| Receiver | R&S | ESRP | 101154 | May 24, 2022 | May 23, 2023 |
| Amplifier | SKET | LAPA_01G18 G-45dB | \ | May 24, 2022 | May 23, 2023 |
| Amplifier | Schwarzbeck | BBV9744 | 9744-0037 | May 24, 2022 | May 23, 2023 |
| TRILOG Broadband Antenna | Schwarzbeck | VULB9163 | 942 | May 26, 2022 | May 25, 2023 |
| Horn Antenna | Schwarzbeck | BBHA9120D | 1541 | Jun. 06, 2022 | Jun. 05, 2023 |
| Horn Antenna(18G Hz-40GHz) | Schwarzbeck | BBHA9170 | 00822 | Jun. 06, 2022 | Jun. 05, 2023 |
| Amplifier(18G Hz-40GHz) | MITEQ | TTA1840-35- HG | 2034381 | May 26, 2022 | May 25, 2023 |
| Loop Antenna(9KHz -30MHz) | Schwarzbeck | FMZB1519B | 00014 | May 26, 2022 | May 25, 2023 |
| Power Metter | Keysight | E4419 | \ | May 26, 2022 | May 25, 2023 |
| Power Sensor (AV) | Keysight | E9300A | \ | May 26, 2022 | May 25, 2023 |
| Signal Analyzer20kH z-26.5GHz | Keysight | N9020A | MY49100060 | May 26, 2022 | May 25, 2023 |
| Spectrum Analyzer9kHz- 40GHz | R&S | FSP40 | \ | May 26, 2022 | May 25, 2023 |
| Software | Frad | EZ-EMC | FA-03A2 RE | \ | \ |

TE
 TC
 OVE
 检

6. Conducted Emissions

6.1 Block Diagram Of Test Setup

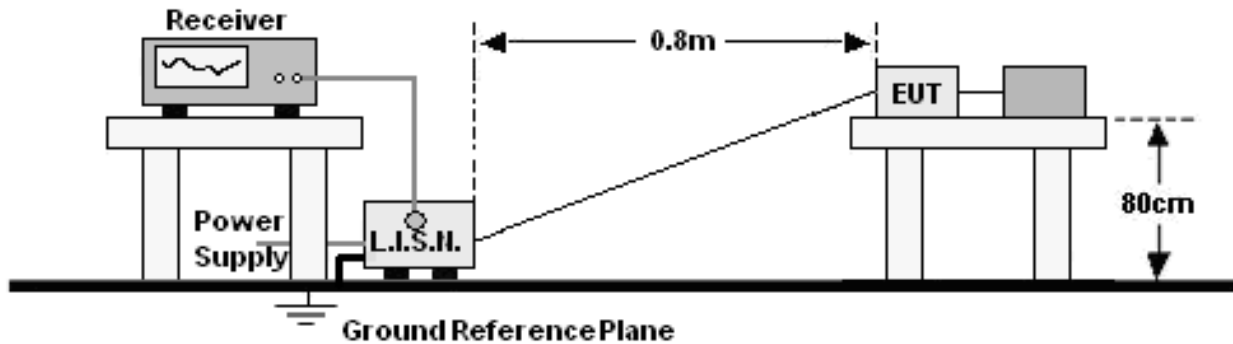

6.2 Limit

| FREQUENCY (MHz) | Limit (dBuV) | |
|-----------------|--------------|-----------|
| | Quas-peak | Average |
| 0.15 -0.5 | 66 - 56 * | 56 - 46 * |
| 0.50 -5.0 | 56.00 | 46.00 |
| 5.0 -30.0 | 60.00 | 50.00 |

Notes:
 1. *Decreasing linearly with logarithm of frequency.
 2. The lower limit shall apply at the transition frequencies.

6.3 Test Procedure

| Receiver Parameters | Setting |
|---------------------|----------|
| Attenuation | 10 dB |
| Start Frequency | 0.15 MHz |
| Stop Frequency | 30 MHz |
| IF Bandwidth | 9 kHz |

- The Product was placed on a nonconductive table 0.8 m above the horizontal ground reference plane, and 0.4 m from the vertical ground reference plane, and connected to the main through Line Impedance Stability Network (L.I.S.N).
- The RBW of the receiver was set at 9 kHz in 150 kHz ~ 30MHz with Peak and AVG detector in Max Hold mode. Run the receiver's pre-scan to record the maximum disturbance generated from Product in all power lines in the full band.
- For each frequency whose maximum record was higher or close to limit, measure its QP and AVG values and record.

6.4 EUT Operating Conditions

The EUT was configured for testing in a typical fashion (as a customer would normally use it). The EUT has been programmed to continuously transmit during test. This operating condition was tested and used to collect the included data.

6.5 Test Result

| | | | |
|----------------|--------------|--------------------|--------|
| Temperature: | 26 °C | Relative Humidity: | 54% |
| Pressure: | 101kPa | Phase : | Line |
| Test Voltage : | AC 120V/60Hz | Test Mode: | Mode 1 |

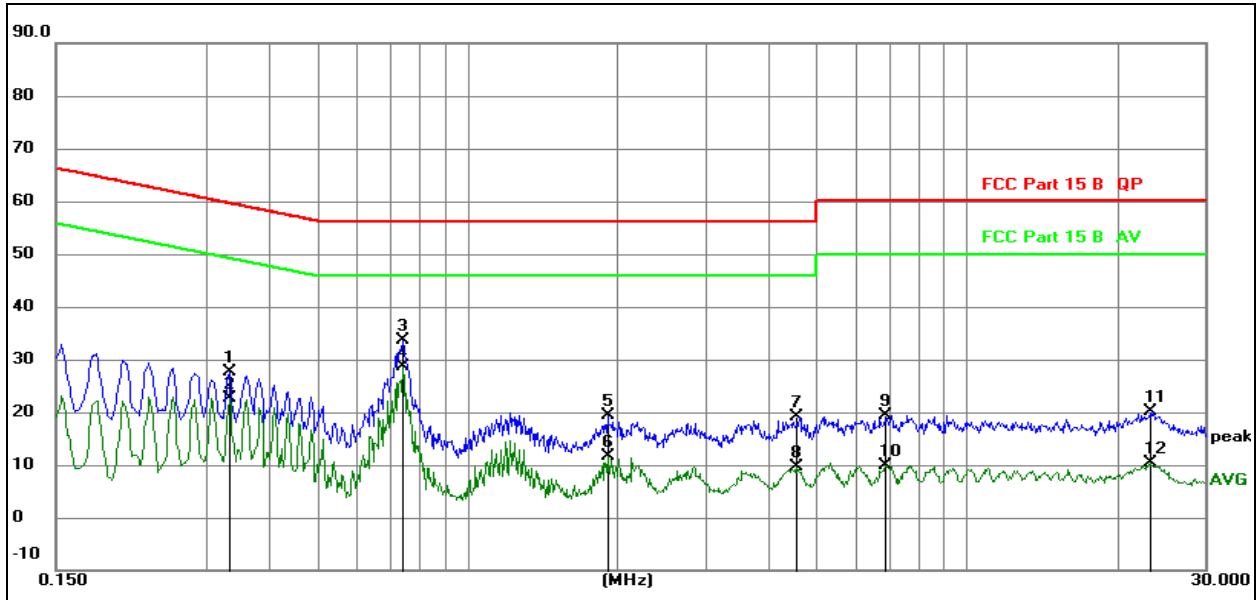

Remark:

1. All readings are Quasi-Peak and Average values.
2. Factor = Insertion Loss + Cable Loss.
3. Measurement=Reading Level+ Correct Factor
4. Over=Measurement-Limit

| No. | Mk. | Freq. MHz | Reading Level | Correct Factor dB | Measure- ment dBuV | Limit dBuV | Over dB | Detector |
|-----|-----|--------------|------------------|-------------------------|--------------------------|---------------|------------|----------|
| 1 | | 0.3338 | 7.93 | 19.76 | 27.69 | 59.36 | -31.67 | QP |
| 2 | | 0.3338 | 2.99 | 19.76 | 22.75 | 49.36 | -26.61 | AVG |
| 3 | | 0.7430 | 13.88 | 19.74 | 33.62 | 56.00 | -22.38 | QP |
| 4 | * | 0.7430 | 8.81 | 19.74 | 28.55 | 46.00 | -17.45 | AVG |
| 5 | | 1.9080 | -0.61 | 19.87 | 19.26 | 56.00 | -36.74 | QP |
| 6 | | 1.9080 | -8.14 | 19.87 | 11.73 | 46.00 | -34.27 | AVG |
| 7 | | 4.5494 | -0.98 | 20.11 | 19.13 | 56.00 | -36.87 | QP |
| 8 | | 4.5494 | -10.42 | 20.11 | 9.69 | 46.00 | -36.31 | AVG |
| 9 | | 6.8775 | -0.69 | 20.18 | 19.49 | 60.00 | -40.51 | QP |
| 10 | | 6.8775 | -10.31 | 20.18 | 9.87 | 50.00 | -40.13 | AVG |
| 11 | | 23.3869 | -0.40 | 20.52 | 20.12 | 60.00 | -39.88 | QP |
| 12 | | 23.3869 | -10.15 | 20.52 | 10.37 | 50.00 | -39.63 | AVG |

| | | | |
|----------------|--------------|--------------------|---------|
| Temperature: | 26 °C | Relative Humidity: | 54% |
| Pressure: | 101kPa | Phase : | Neutral |
| Test Voltage : | AC 120V/60Hz | Test Mode: | Mode 1 |

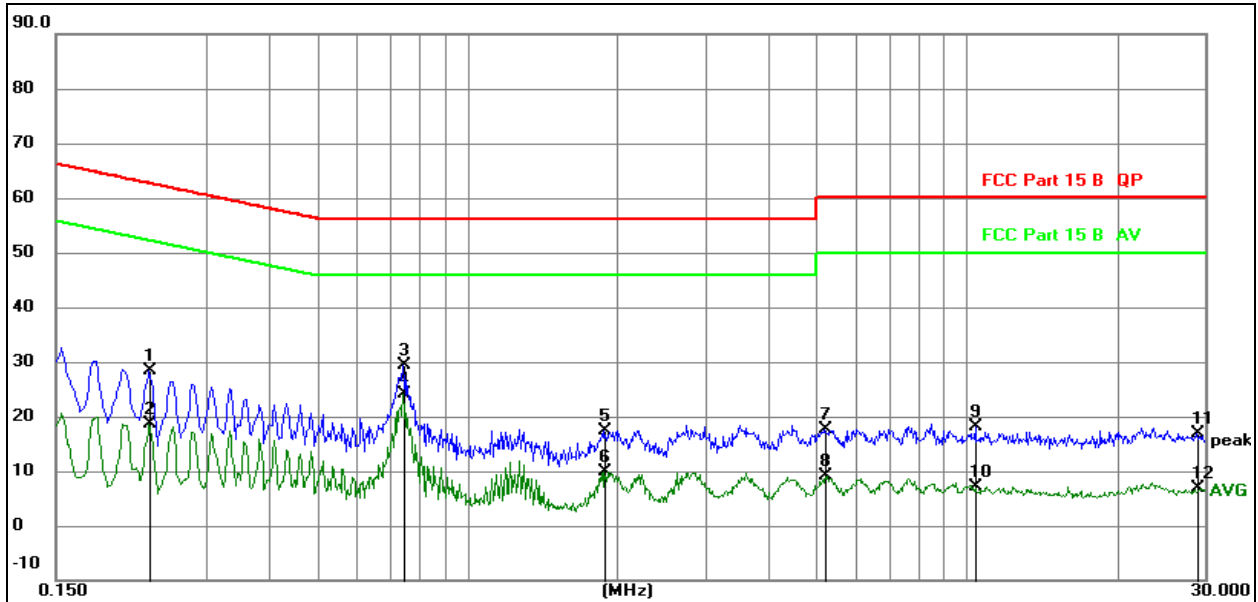
Remark:

1. All readings are Quasi-Peak and Average values.
2. Factor = Insertion Loss + Cable Loss.
3. Measurement=Reading Level+ Correct Factor
4. Over= Measurement-Limit

| No. | Mk. | Freq. MHz | Reading Level dB | Correct Factor dB | Measure- ment dBuV | Limit dBuV | Over dB | Detector |
|-----|-----|--------------|------------------------|-------------------------|--------------------------|---------------|------------|----------|
| 1 | | 0.2310 | 8.66 | 19.79 | 28.45 | 62.41 | -33.96 | QP |
| 2 | | 0.2310 | -1.04 | 19.79 | 18.75 | 52.41 | -33.66 | AVG |
| 3 | | 0.7440 | 9.56 | 19.74 | 29.30 | 56.00 | -26.70 | QP |
| 4 | * | 0.7440 | 4.47 | 19.74 | 24.21 | 46.00 | -21.79 | AVG |
| 5 | | 1.8870 | -2.49 | 19.87 | 17.38 | 56.00 | -38.62 | QP |
| 6 | | 1.8870 | -10.03 | 19.87 | 9.84 | 46.00 | -36.16 | AVG |
| 7 | | 5.2035 | -2.46 | 20.13 | 17.67 | 60.00 | -42.33 | QP |
| 8 | | 5.2035 | -11.05 | 20.13 | 9.08 | 50.00 | -40.92 | AVG |
| 9 | | 10.4100 | -2.10 | 20.28 | 18.18 | 60.00 | -41.82 | QP |
| 10 | | 10.4100 | -13.24 | 20.28 | 7.04 | 50.00 | -42.96 | AVG |
| 11 | | 28.9770 | -3.70 | 20.53 | 16.83 | 60.00 | -43.17 | QP |
| 12 | | 28.9770 | -13.67 | 20.53 | 6.86 | 50.00 | -43.14 | AVG |

SHENZHEN

7. Radiated Emissions

7.1 Block Diagram Of Test Setup

(A) Radiated Emission Test-Up Frequency Below 30MHz

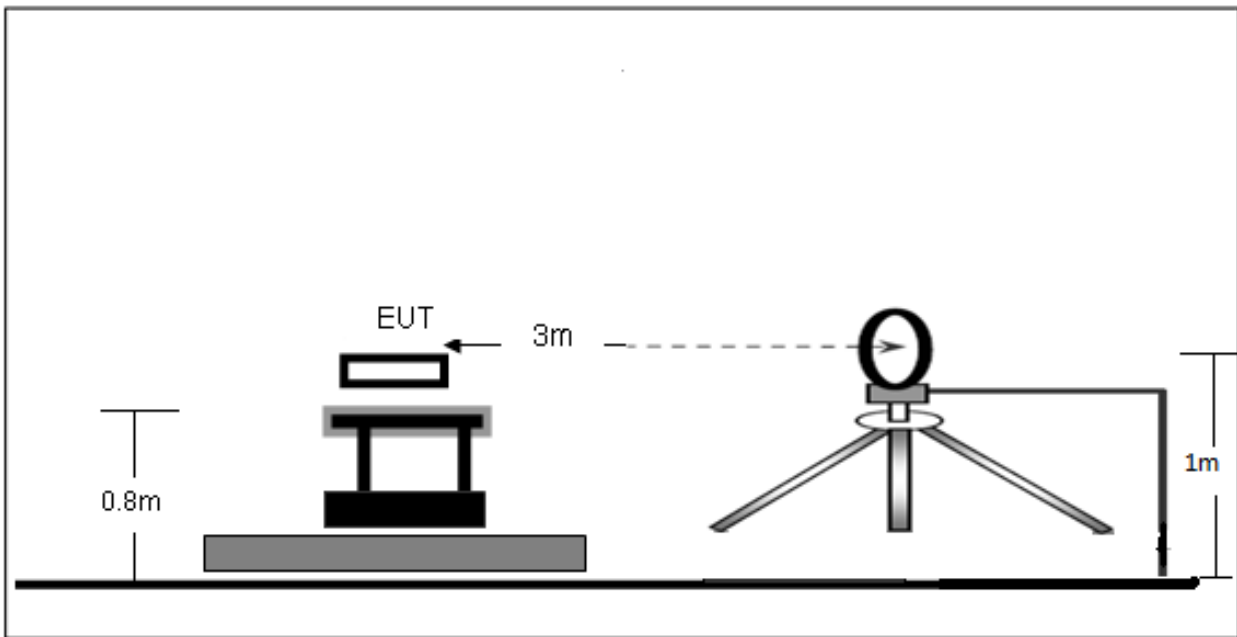

(B) Radiated Emission Test-Up Frequency 30MHz~1GHz

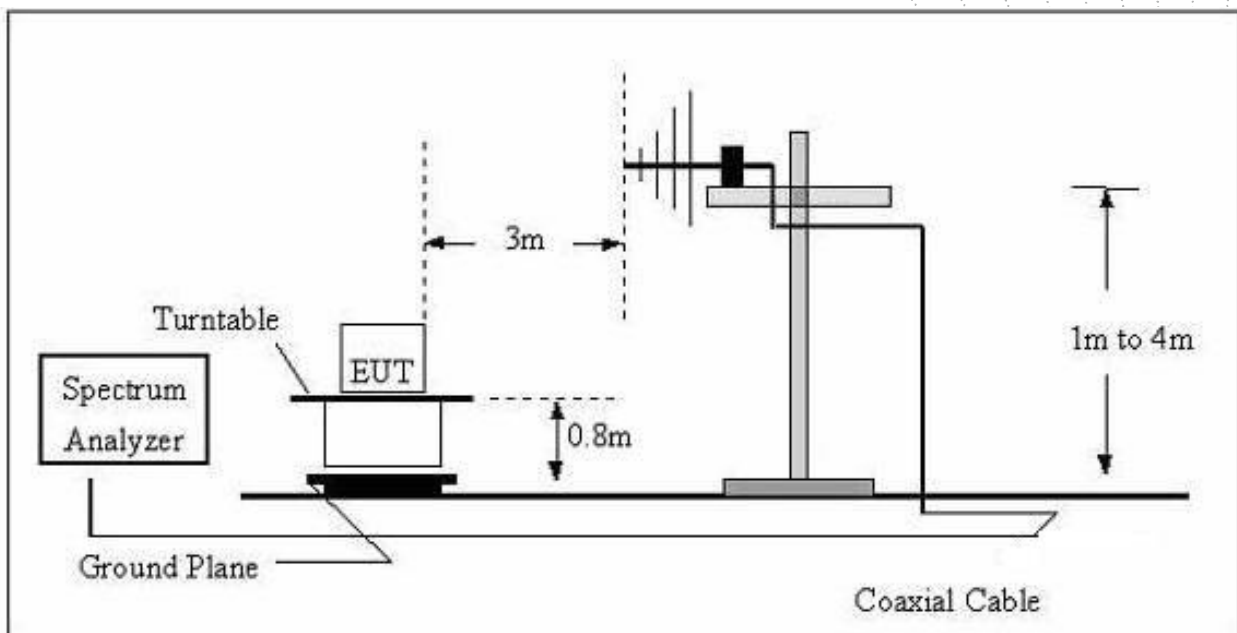

(C) Radiated Emission Test-Up Frequency Above 1GHz

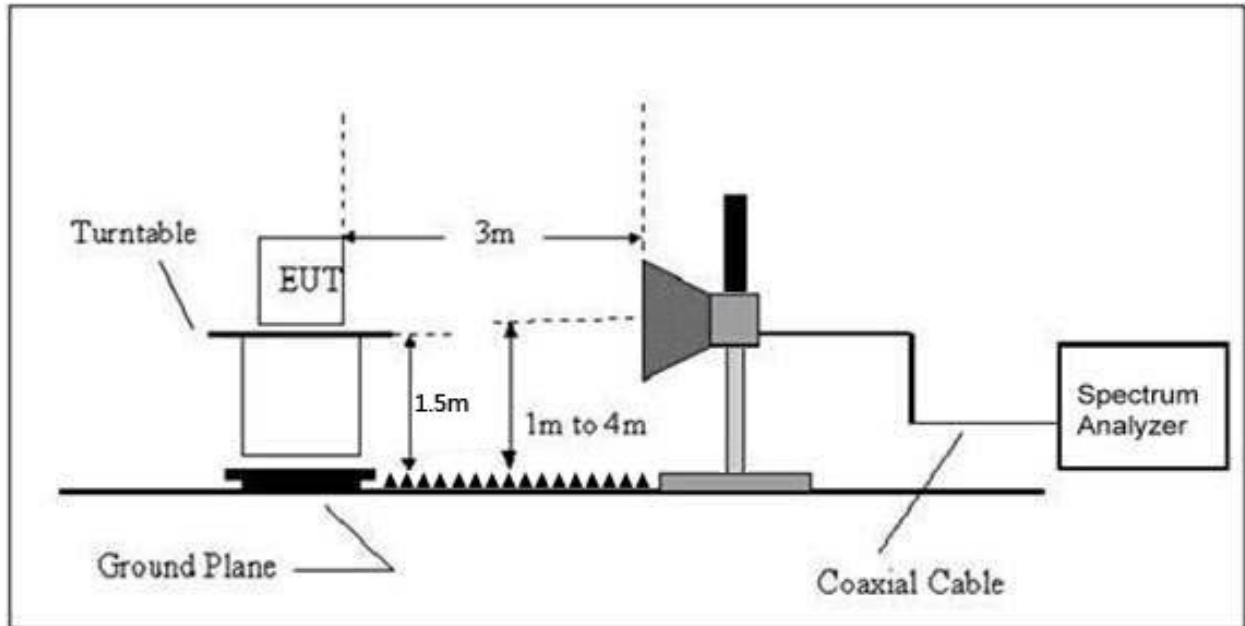

7.2 Limit

20dBc in any 100 kHz bandwidth outside the operating frequency band. In case the emission fall within the restricted band specified on 15.205(a), then the 15.209(a) limit in the table below has to be followed.

| Frequency (MHz) | Field Strength uV/m | Distance (m) | Field Strength Limit at 3m Distance | |
|-----------------|---------------------|--------------|-------------------------------------|--------------------------------|
| | | | uV/m | dBuV/m |
| 0.009 ~ 0.490 | 2400/F(kHz) | 300 | 10000 * 2400/F(kHz) | $20\log^{(2400/F(kHz))} + 80$ |
| 0.490 ~ 1.705 | 24000/F(kHz) | 30 | 100 * 24000/F(kHz) | $20\log^{(24000/F(kHz))} + 40$ |
| 1.705 ~ 30 | 30 | 30 | 100 * 30 | $20\log^{(30)} + 40$ |
| 30 ~ 88 | 100 | 3 | 100 | $20\log^{(100)}$ |
| 88 ~ 216 | 150 | 3 | 150 | $20\log^{(150)}$ |
| 216 ~ 960 | 200 | 3 | 200 | $20\log^{(200)}$ |
| Above 960 | 500 | 3 | 500 | $20\log^{(500)}$ |

LIMITS OF RADIATED EMISSION MEASUREMENT (Above 1000MHz)

| FREQUENCY (MHz) | Limit (dBuV/m) (at 3M) | |
|-----------------|------------------------|---------|
| | PEAK | AVERAGE |
| Above 1000 | 74 | 54 |

Notes:

- (1)The limit for radiated test was performed according to FCC PART 15C.
- (2)The tighter limit applies at the band edges.
- (3) Emission level (dBuV/m)=20log Emission level (uV/m).

FREQUENCY RANGE OF RADIATED MEASUREMENT (For unintentional radiators)

| Highest frequency generated or Upper frequency of measurement used in the device or on which the device operates or tunes (MHz) | Range (MHz) |
|---|---|
| Below 1.705 | 30 |
| 1.705 – 108 | 1000 |
| 108 – 500 | 2000 |
| 500 – 1000 | 5000 |
| Above 1000 | 5 th harmonic of the highest frequency or 40 GHz, whichever is lower |

7.3 Test Procedure

| Receiver Parameter | Setting |
|--------------------|-------------------|
| Attenuation | Auto |
| 9kHz~150kHz | RBW 200Hz for QP |
| 150kHz~30MHz | RBW 9kHz for QP |
| 30MHz~1000MHz | RBW 120kHz for QP |

| Spectrum Parameter | Setting |
|--------------------|--|
| 1-6GHz | RBW 1 MHz /VBW 1 MHz for Peak, RBW 1 MHz / VBW 10Hz for Average |

Below 1GHz test procedure as below:

- a. The EUT was placed on the top of a rotating table 0.8 meters above the ground at a 3 meter semi-anechoic chamber. The table was rotated 360 degrees to determine the position of the highest radiation.
- b. The EUT was set 3 meters away from the interference-receiving antenna, which was mounted on the top of a variable-height antenna tower.
- c. The antenna height is varied from one meter to four meters above the ground to determine the maximum value of the field strength. Both horizontal and vertical polarizations of the antenna are set to make the measurement.
- d. For each suspected emission, the EUT was arranged to its worst case and then the antenna was tuned to heights from 1 meter to 4 meters (for the test frequency of below 30MHz, the antenna was tuned to heights 1 meter) and the rotatable table was turned from 0 degrees to 360 degrees to find the maximum reading.
- e. The test-receiver system was set to Peak Detect Function and Specified Bandwidth with Maximum Hold Mode.
- f. If the emission level of the EUT in peak mode was 10dB lower than the limit specified, then testing could be stopped and the peak values of the EUT would be reported. Otherwise the emissions that did not have 10dB margin would be re-tested one by one using peak, quasi-peak or average method as specified and then reported in a data sheet.

Above 1GHz test procedure as below:

- g. Different between above is the test site, change from Semi- Anechoic Chamber to fully Anechoic Chamber and change form table 0.8 metre to 1.5 metre(Above 18GHz the distance is 1 meter and table is 1.5 metre).
- h. Test the EUT in the lowest channel, the middle channel ,the Highest channel.



Note:

Both horizontal and vertical antenna polarities were tested and performed pretest to three orthogonal axis. The worst case emissions were reported.

Above 1GHz test procedure as below:

- a. The EUT was placed on the top of a rotating table 1.5 meters above the ground at a 3 meter chamber. The table was rotated 360 degrees to determine the position of the highest radiation.
- b. The EUT was set 3 meters away from the interference-receiving antenna, which was mounted on the top of a variable-height antenna tower.
- c. The antenna height is varied from one meter to four meters above the ground to determine the maximum value of the field strength. Both horizontal and vertical polarizations of the antenna are set to make the measurement.
- d. For each suspected emission, the EUT was arranged to its worst case and then the antenna was tuned to heights from 1 meter to 4 meters and the rota table was turned from 0 degrees to 360 degrees to find the maximum reading.
- e. The test-receiver system was set to Peak Detect Function and Specified Bandwidth with Maximum Hold Mode.
- f. If the emission level of the EUT in peak mode was 10dB lower than the limit specified, then testing could be stopped and the peak values of the EUT would be reported. Otherwise the emissions that did not have 10dB margin would be re-tested one by one using peak, quasi-peak or average method as specified and then reported in a data sheet.
- g. Test the EUT in the lowest channel, the Highest channel.

Note:

Both horizontal and vertical antenna polarities were tested and performed pretest to three orthogonal axis. The worst case emissions were reported.

7.4 EUT Operating Conditions

The EUT was configured for testing in a typical fashion (as a customer would normally use it). The EUT has been programmed to continuously transmit during test. This operating condition was tested and used to collect the included data.

7.5 Test Result

Below 30MHz

| | | | |
|--------------|---------|--------------------|---------|
| Temperature: | 26°C | Relative Humidity: | 24% |
| Pressure: | 101 kPa | Test Voltage : | DC 3.7V |
| Test Mode : | Mode 2 | Polarization : | -- |

| Freq. (MHz) | Reading (dBuV/m) | Limit (dBuV/m) | Margin (dB) | State P/F |
|----------------|---------------------|-------------------|----------------|--------------|
| -- | -- | -- | -- | PASS |
| -- | -- | -- | -- | PASS |

Note:

The amplitude of spurious emissions which are attenuated by more than 20dB below the permissible value has no need to be reported.

Distance extrapolation factor = $40 \log(\text{specific distance}/\text{test distance})(\text{dB})$;

Limit line = specific limits(dBuv) + distance extrapolation factor.



Between 30MHz – 1GHz

| | | | |
|--------------|--------|--------------------|------------|
| Temperature: | 26 °C | Relative Humidity: | 54% |
| Pressure: | 101KPa | Phase : | Horizontal |
| Test Mode: | Mode 2 | Remark: | N/A |

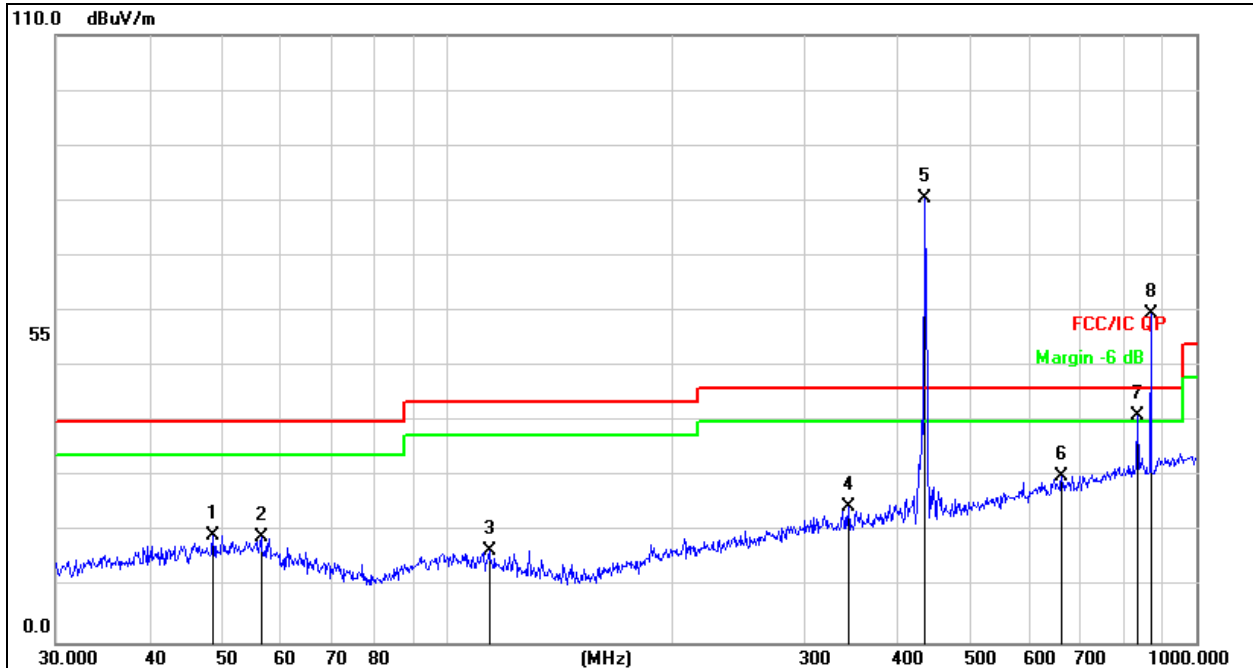

Remark:

1. Factor = Antenna Factor + Cable Loss – Pre-amplifier.
2. Measurement=Reading Level+ Correct Factor
3. Over= Measurement-Limit

| No. Mk. | Freq. MHz | Reading Level dBuV | Correct Factor dB | Measure- ment dBuV/m | Limit dB/m | Over dB | Detector |
|---------|--------------|--------------------------|-------------------------|----------------------------|---------------|------------|----------|
| 1 | 48.6719 | 34.55 | -15.20 | 19.35 | 40.00 | -20.65 | QP |
| 2 | 56.3947 | 35.31 | -16.12 | 19.19 | 40.00 | -20.81 | QP |
| 3 | 113.7142 | 34.13 | -17.59 | 16.54 | 43.50 | -26.96 | QP |
| 4 | 343.1800 | 35.73 | -11.08 | 24.65 | 46.00 | -21.35 | QP |
| 5 * | 434.0650 | 89.92 | -9.51 | 80.41 | 100.83 | -20.42 | peak |
| 6 | 661.1504 | 34.73 | -4.56 | 30.17 | 46.00 | -15.83 | QP |
| 7 ! | 833.3170 | 42.98 | -1.92 | 41.06 | 46.00 | -4.94 | QP |
| 8 X | 869.1301 | 60.95 | -1.40 | 59.55 | 80.83 | -21.28 | peak |

| | | | |
|--------------|--------|--------------------|----------|
| Temperature: | 26 °C | Relative Humidity: | 54% |
| Pressure: | 101KPa | Phase : | Vertical |
| Test Mode: | Mode 2 | Remark: | N/A |

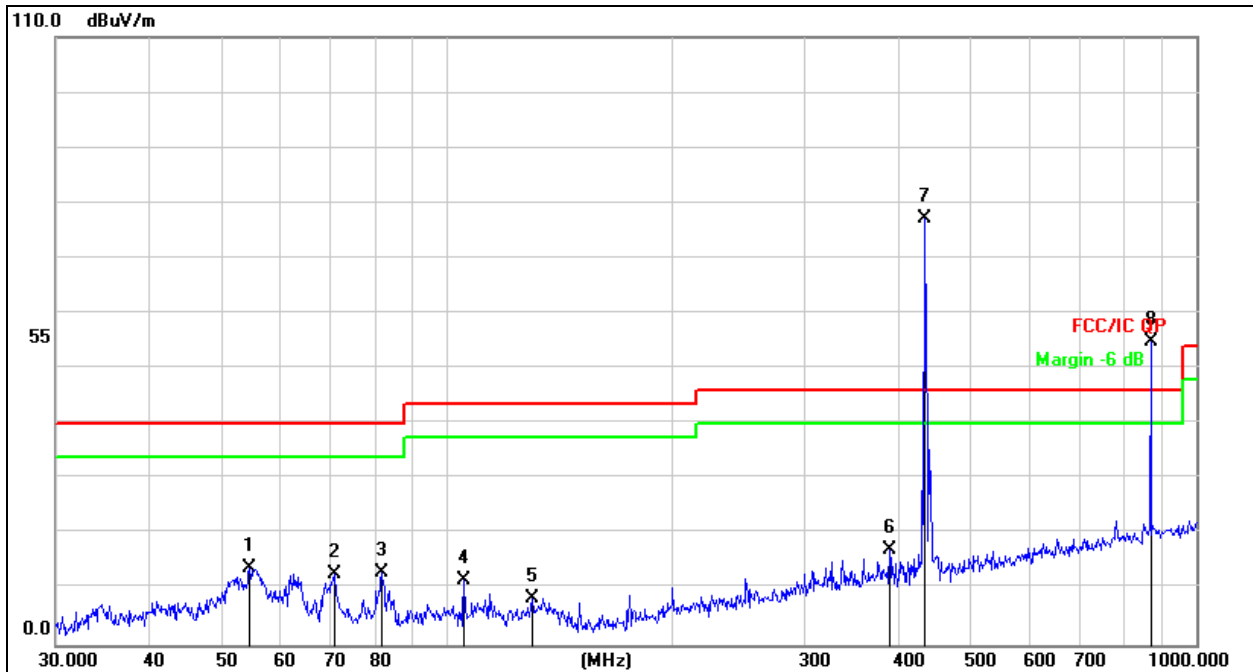

Remark:
 1. Factor = Antenna Factor + Cable Loss – Pre-amplifier.
 2. Measurement=Reading Level+ Correct Factor
 3. Over= Measurement-Limit

| No. | Mk. | Freq. MHz | Reading Level dBuV | Correct Factor dB | Measure- ment dBuV/m | Limit dB/m | Over dB | Detector |
|-----|-----|--------------|--------------------------|-------------------------|----------------------------|---------------|------------|----------|
| 1 | | 54.4516 | 29.66 | -15.79 | 13.87 | 40.00 | -26.13 | QP |
| 2 | | 70.8315 | 32.11 | -19.28 | 12.83 | 40.00 | -27.17 | QP |
| 3 | | 81.7833 | 33.32 | -20.32 | 13.00 | 40.00 | -27.00 | QP |
| 4 | | 105.2718 | 28.85 | -17.06 | 11.79 | 43.50 | -31.71 | QP |
| 5 | | 129.9226 | 26.87 | -18.60 | 8.27 | 43.50 | -35.23 | QP |
| 6 | | 389.3549 | 27.40 | -10.26 | 17.14 | 46.00 | -28.86 | QP |
| 7 | * | 434.0651 | 86.66 | -9.51 | 77.15 | 100.83 | -23.68 | peak |
| 8 | X | 869.1302 | 56.14 | -1.40 | 54.74 | 80.83 | -26.09 | peak |

For average Emission

| Frequency MHz | Peak Level dBuV/m | Duty cycle factor | Average Level dBuV/m | Limit AV | Margin | Polarization |
|---------------|-------------------|-------------------|----------------------|----------|--------|--------------|
| 433.92 | 80.41 | -12.84 | 67.57 | 80.83 | -13.26 | Horizontal |
| 867.84 | 59.55 | -12.84 | 46.71 | 60.83 | -14.12 | Horizontal |

Notes: 1. Average emission Level = Peak Level + Duty cycle factor
2. Duty cycle level please see clause 5.

| Frequency MHz | Peak Level dBuV/m | Duty cycle factor | Average Level dBuV/m | Limit AV | Margin | Polarization |
|---------------|-------------------|-------------------|----------------------|----------|--------|--------------|
| 433.92 | 77.15 | -12.84 | 64.31 | 80.83 | -16.52 | Vertical |
| 867.84 | 54.74 | -12.84 | 41.90 | 60.83 | -18.93 | Vertical |

Notes: 1. Average emission Level = Peak Level + Duty cycle factor
2. Duty cycle level please see clause 5.

 Radiated Spurious Emission (1GHz to 10th harmonics)

| Frequency MHz | Peak Level dBuV/m | Duty cycle factor | Average Level dBuV/m | Limit | | Margin dB | | Polarization |
|---------------|-------------------|-------------------|----------------------|-------|-------|-----------|--------|--------------|
| | | | | PK | AV | PK | AV | |
| 1301.76 | 51.14 | -12.84 | 39.41 | 74.00 | 54.00 | -22.86 | -15.70 | Vertical |
| 1735.68 | 52.67 | -12.84 | 40.93 | 80.83 | 60.83 | -28.16 | -21.00 | Vertical |
| 2603.52 | 51.20 | -12.84 | 39.46 | 80.83 | 60.83 | -29.63 | -22.47 | Vertical |
| 3037.44 | 52.77 | -12.84 | 41.03 | 74.00 | 54.00 | -21.23 | -14.07 | Vertical |
| 3471.36 | 50.71 | -12.84 | 38.98 | 80.83 | 60.83 | -30.12 | -22.96 | Vertical |
| 3905.28 | 47.45 | -12.84 | 35.72 | 74.00 | 54.00 | -26.55 | -19.39 | Vertical |
| 1301.76 | 47.02 | -12.84 | 35.29 | 74.00 | 54.00 | -26.98 | -19.82 | Horizontal |
| 1735.68 | 46.81 | -12.84 | 35.08 | 80.83 | 60.83 | -34.02 | -26.86 | Horizontal |
| 2603.52 | 49.33 | -12.84 | 37.59 | 80.83 | 60.83 | -31.50 | -24.34 | Horizontal |
| 3037.44 | 49.50 | -12.84 | 37.76 | 74.00 | 54.00 | -24.50 | -17.34 | Horizontal |
| 3471.36 | 46.98 | -12.84 | 35.25 | 80.83 | 60.83 | -33.85 | -26.69 | Horizontal |
| 3905.28 | 48.37 | -12.84 | 36.64 | 74.00 | 54.00 | -25.63 | -18.47 | Horizontal |

Notes: 1. Average emission Level = Peak Level + Duty cycle factor
2. Duty cycle level please see clause 9.
3. Pulse Desensitization Correction Factor
Pulse Width (PW) =41.60ms
RBW=1 MHz
PW(41.60 ms) > 1/RBW (1us)
Therefore PDCF is not needed
4. Other harmonics emissions are lower than 20dB below the allowable limit.

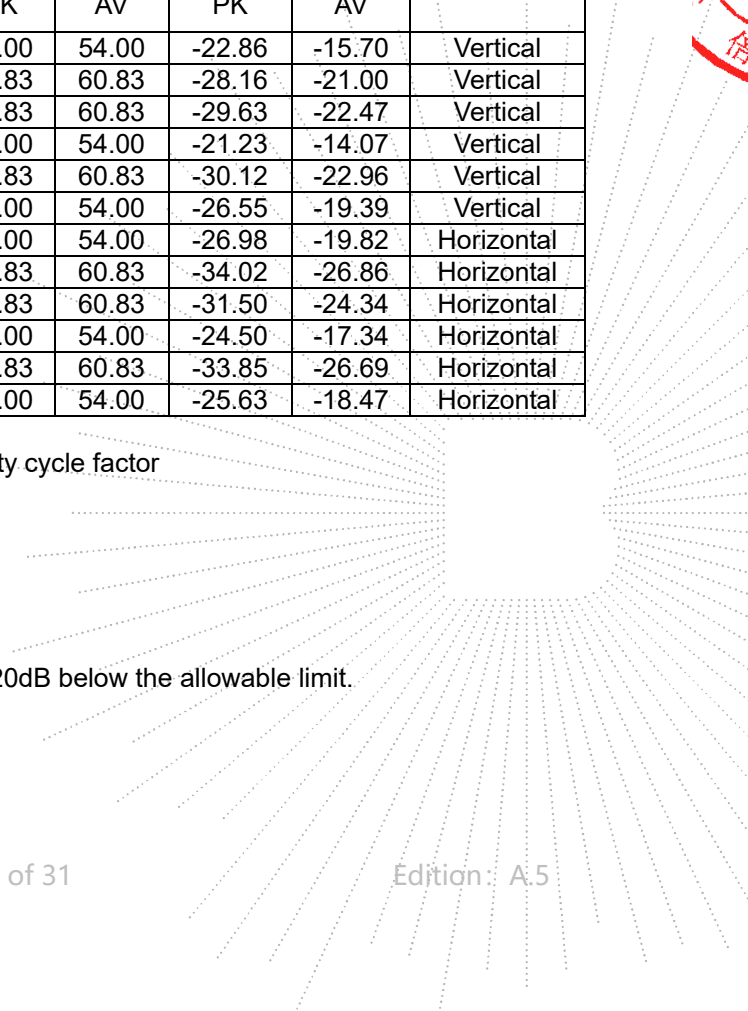

8. Bandwidth Test

8.1 Block Diagram Of Test Setup

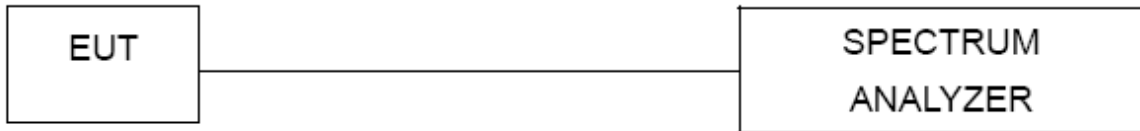

8.2 Limit

According to FCC 15.231(c) requirement:

The bandwidth of the emission shall be no wider than 0.25% of the center frequency for devices operating between 70 MHz to 900 MHz. Those devices operating above 900 MHz, the emission spurious shall be no wider than 0.5% of the center frequency. Bandwidth is determined at the points 20 dB down from the modulated carrier.

$$B.W (20dBc) \text{ Limit} = 0.25\% * f(\text{MHz}) = 0.25\% * 433.92\text{MHz} = 1.0848\text{MHz}$$

| Spectrum Parameter | Setting |
|--------------------|---|
| Attenuation | Auto |
| Span Frequency | > Measurement Bandwidth or Channel Separation |
| RB | 30kHz |
| VB | ≥RBW |
| Detector | Peak |
| Trace | Max Hold |
| Sweep Time | Auto |

8.3 Test Procedure

- The EUT was directly connected to the spectrum analyzer and antenna output port as show in the block diagram below,
- Spectrum Setting : RBW= 30kHz, VBW≥ RBW, Sweep time = Auto.

8.4 EUT Operating Conditions

The EUT tested system was configured as the statements of 2.4 Unless otherwise a special operating condition is specified in the follows during the testing.

8.5 Test Result

| | | | |
|---------------|--------|---------------------|---------|
| Temperature : | 26 °C | Relative Humidity : | 54% |
| Pressure : | 101kPa | Test Voltage : | DC 3.7V |
| Test Mode : | Mode 2 | | |

| Frequency | 20dB Bandwidth (kHz) | Limit (MHz) | Result |
|-----------|----------------------|-------------|--------|
| 433.92MHz | 11.68 | 1.0848 | PASS |

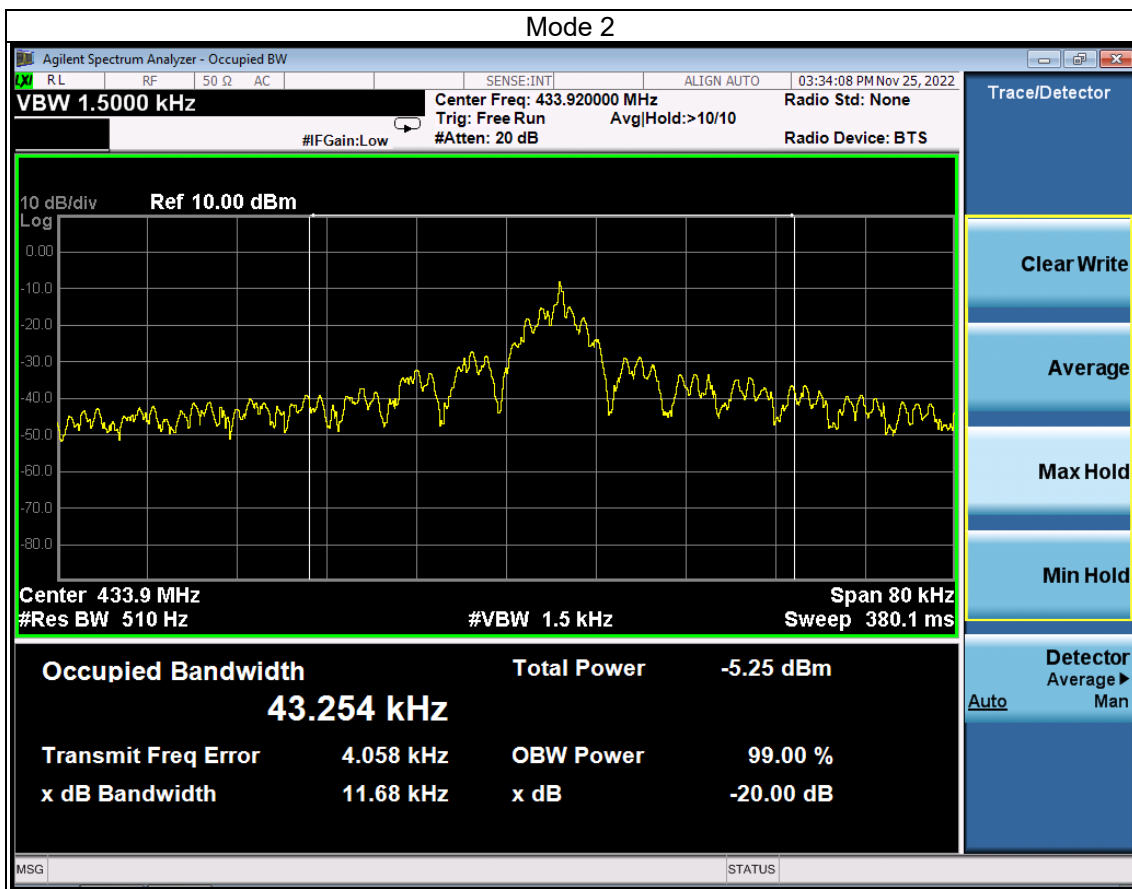

9. Calculation Of Average Factor

The output field strengths of specification in accordance with the FCC rules specify measurements with an average detector. During the test, a spectrum analyzer incorporating a peak detector was used. Therefore, a reduction factor can be applied to the resultant peak signal level and compared to the limit for measurement instrumentation incorporating an average detector.

The duty cycle is measured in 100 ms or the repetition cycle period, whichever is a shorter time frame. The duty cycle is measured by placing the spectrum analyzer to set zero span at 100kHz resolution bandwidth.

Averaging factor in dB = $20\log(\text{duty cycle})$

The duration of one cycle = 41.60ms

The duty cycle is simply the on-time divided the duration of one cycle

Duty Cycle = $(0.906 \text{ ms} * 1 + 0.204 \text{ ms} * 42) / 41.60 \text{ ms}$

= $9.474 \text{ ms} / 41.60 \text{ ms}$

= 0.228

Therefore, the averaging factor is found by $20\log 0.228 = -12.84 \text{ dB}$

Test plot as follows:

Note: During the 100ms, the amount of pulse and on-time of pulse are the same for every pulse train.

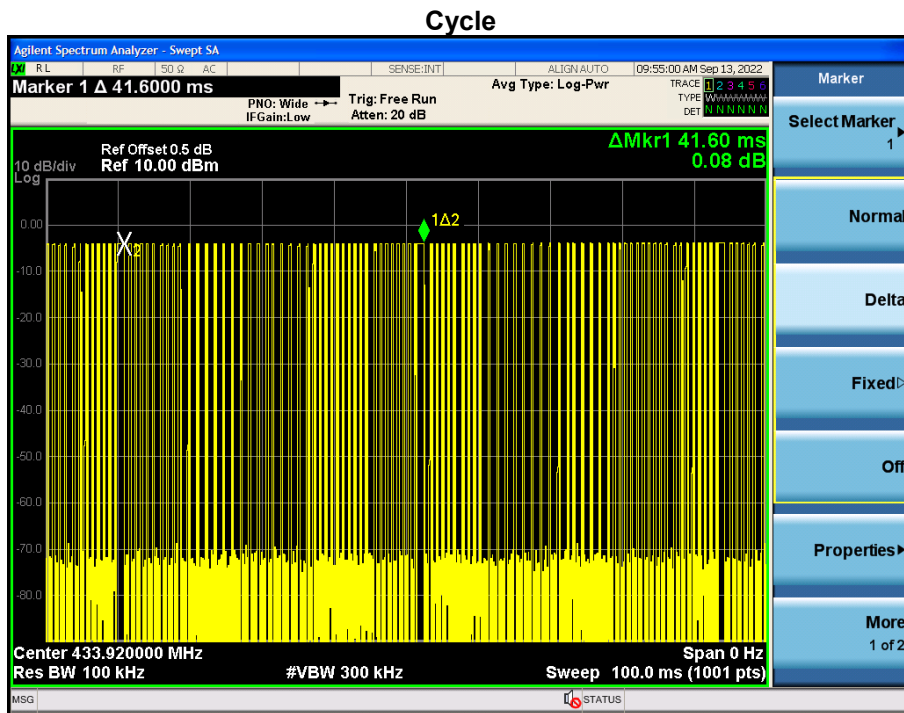

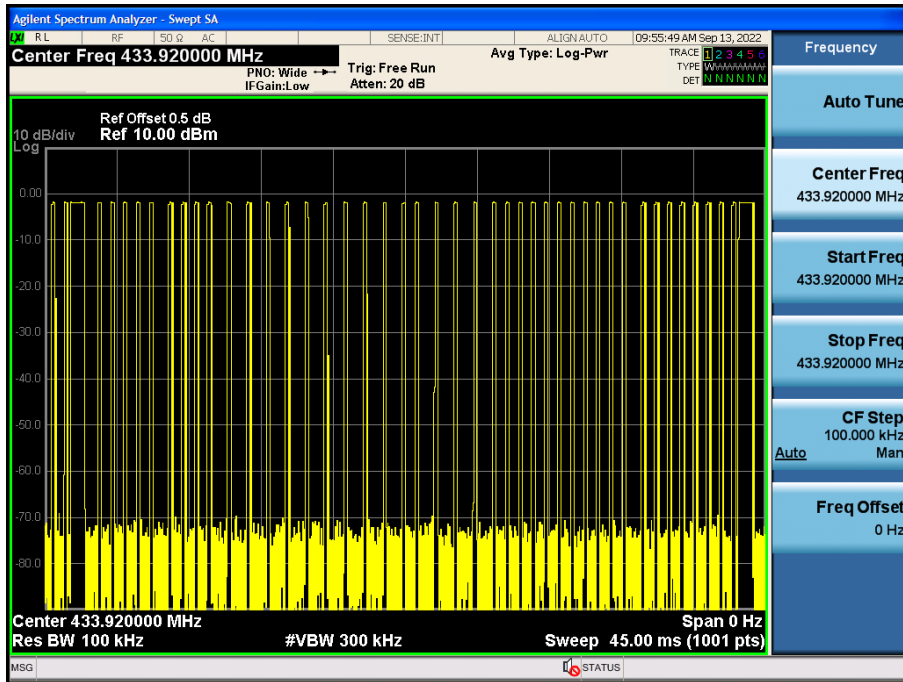
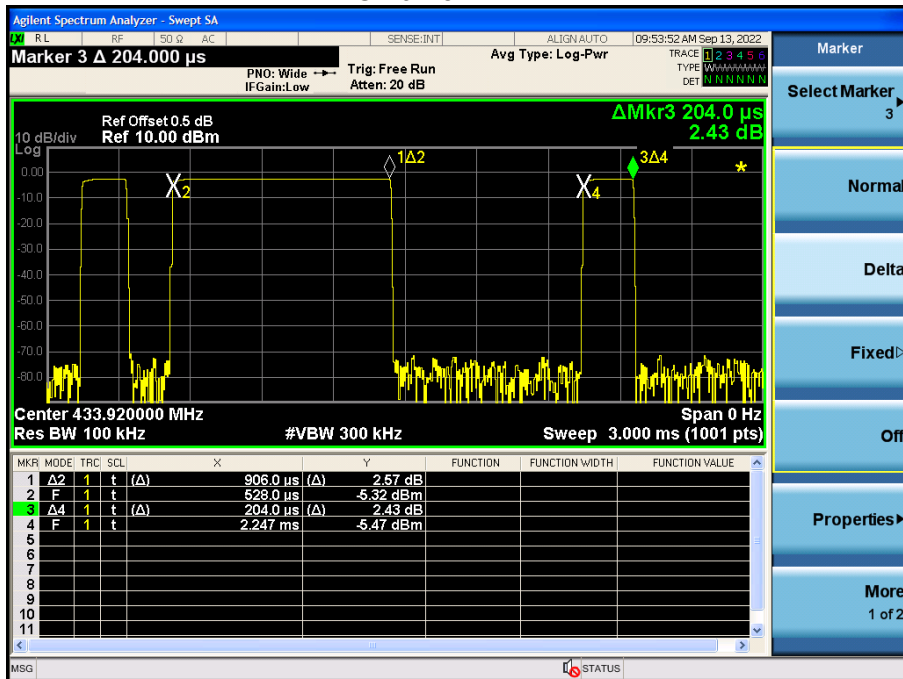
Pulse

On-time

10. Dwell Time

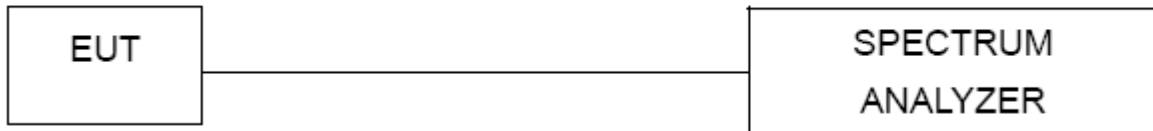
10.1 Block Diagram Of Test Setup



10.2 Limit

According to FCC 15.231(a) requirement:

A manually operated transmitter shall employ a switch that will automatically deactivate the transmitter within not more than 5 seconds of being released.

10.3 Test Procedure

- a) Check the calibration of the measuring instrument using either an internal calibrator or a known signal from an external generator.
- b) Position the EUT without connection to measurement instrument. Turn on the EUT and connect its antenna terminal to measurement instrument via a low loss cable. Then set it to any one measured frequency within its operating range, and make sure the instrument is operated in its linear range.
- c) Set RBW to 100 kHz and VBW of spectrum analyzer to 300 kHz with a convenient frequency span including 100 kHz bandwidth from band edge.
- d) Measure the highest amplitude appearing on spectral display and set it as a reference level. Plot the graph with marking the highest point and edge frequency.
- e) Repeat above procedures until all measured frequencies were complete.

10.4 Test Result

| Dwell time (second) | Limit (second) | Result |
|---------------------|----------------|--------|
| 520ms | <5s | Pass |

Test plot as follows:

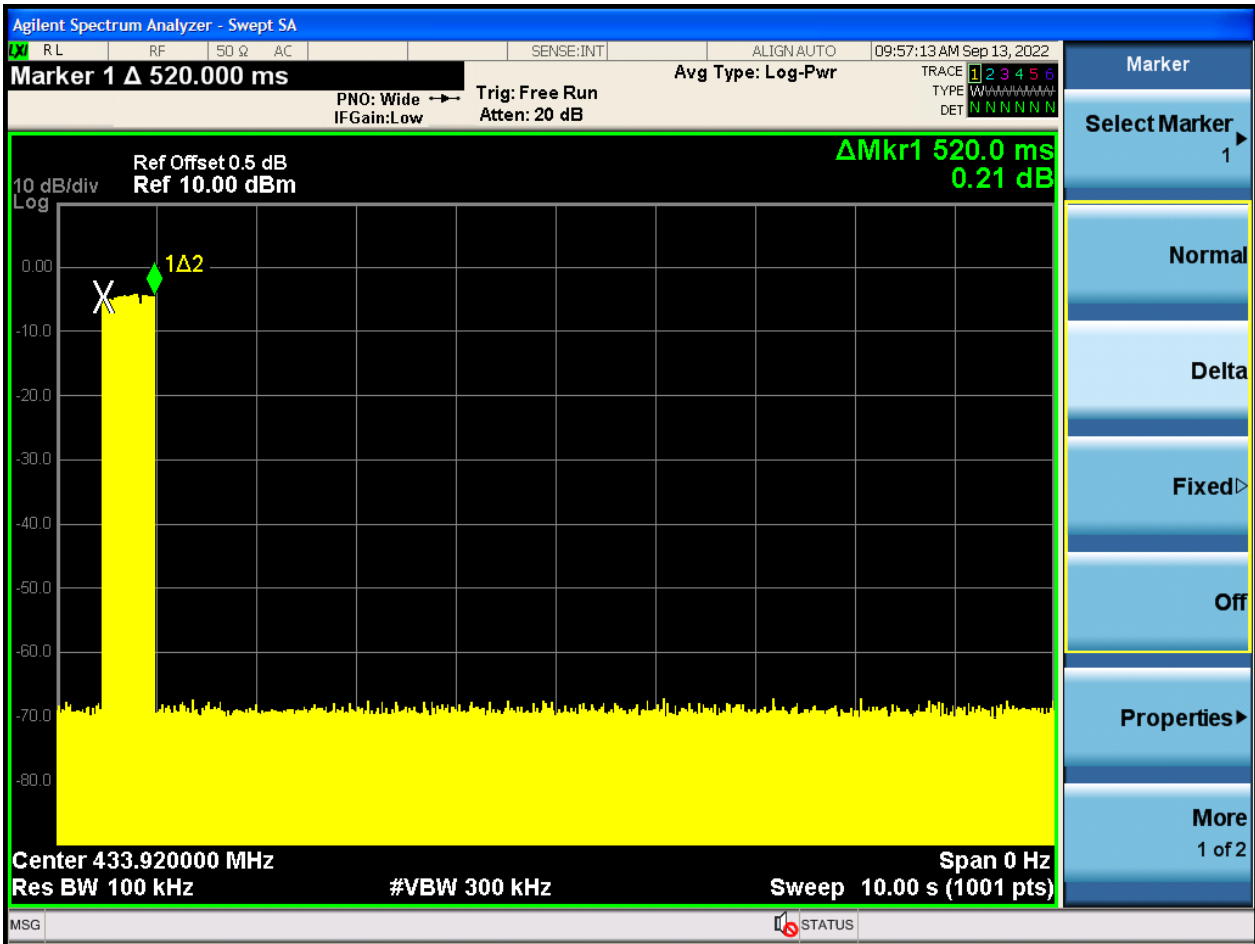

11. Antenna Requirement

11.1 Standard Requirement

15.203 requirement: For intentional device, according to 15.203: an intentional radiator shall be designed to ensure that no antenna other than that furnished by the responsible party shall be used with the device.

11.2 EUT Antenna

The EUT antenna is the Spring antenna. It comply with the standard requirement.

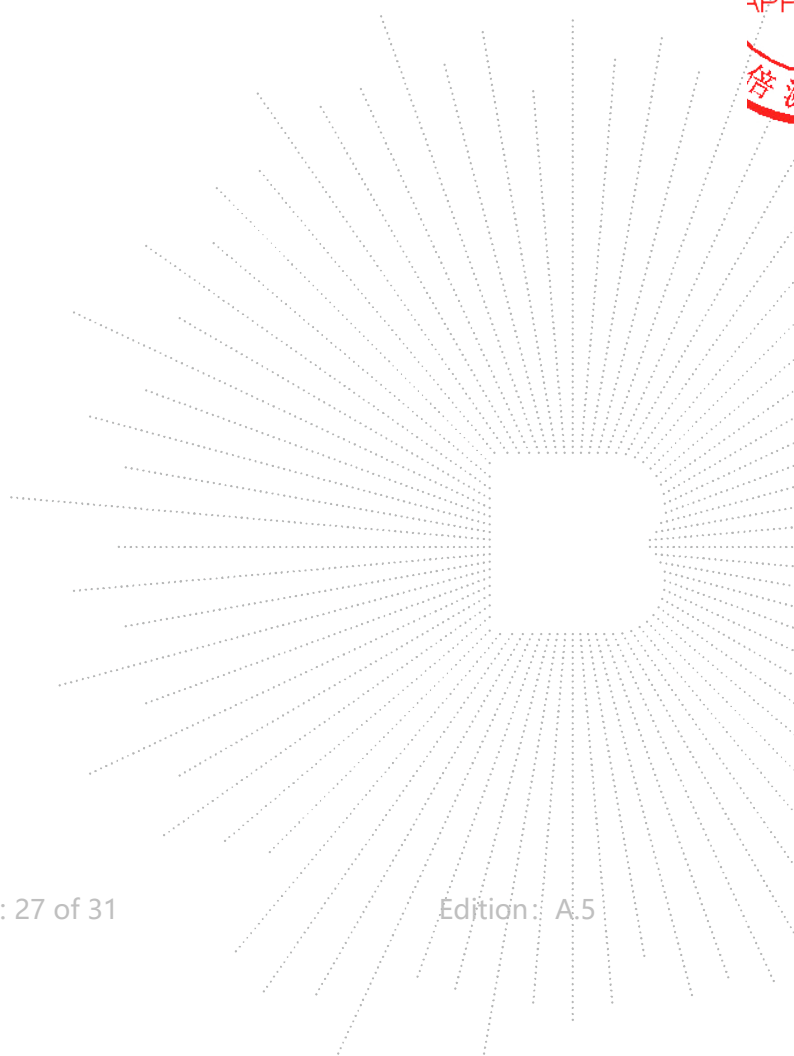

12. EUT Photographs

EUT Photo 1



EUT Photo 2



CT
CT
PROC
刚本

13. EUT Test Setup Photographs

Conducted Emissions Photo



Radiated Measurement Photos

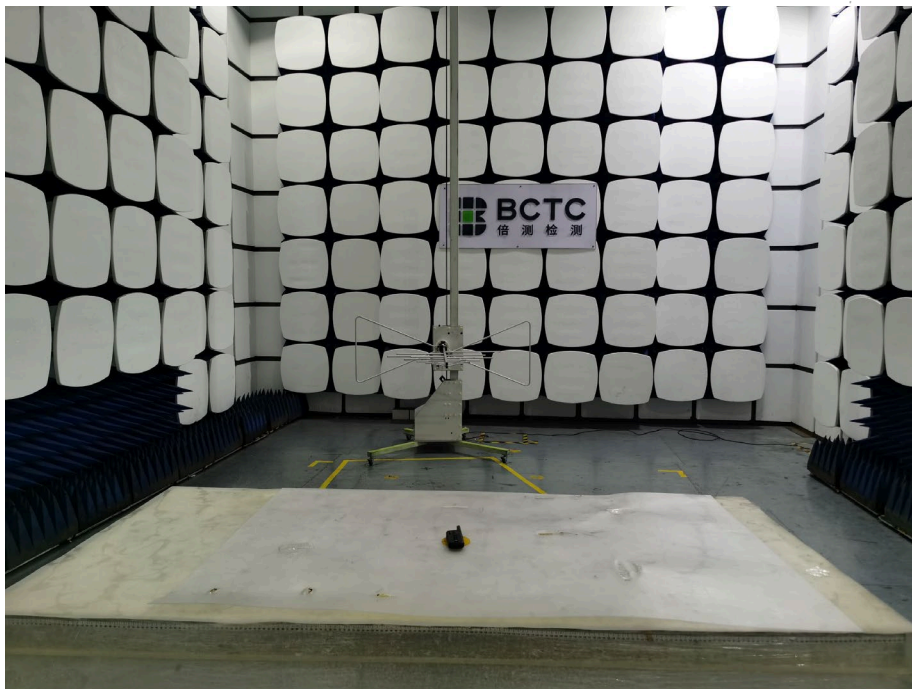

TEST
TC
OVER
BCTC

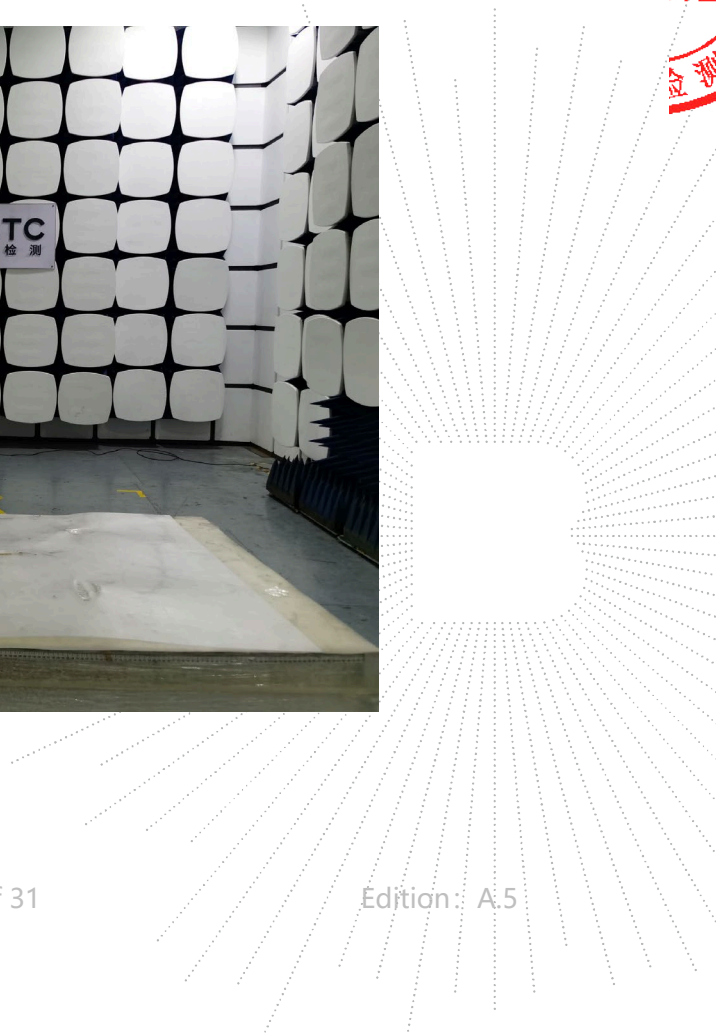

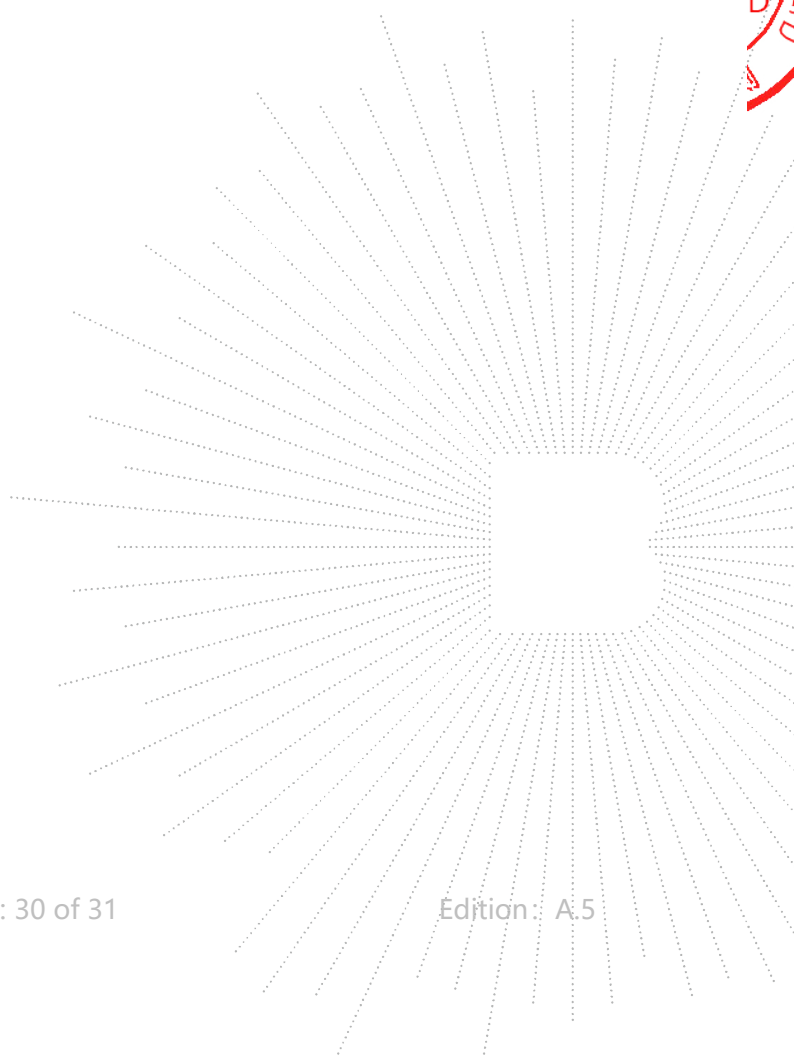

STATEMENT

1. The equipment lists are traceable to the national reference standards.
2. The test report can not be partially copied unless prior written approval is issued from our lab.
3. The test report is invalid without the "special seal for inspection and testing".
4. The test report is invalid without the signature of the approver.
5. The test process and test result is only related to the Unit Under Test.
6. Sample information is provided by the client and the laboratory is not responsible for its authenticity.
7. The test report without CMA mark is only used for scientific research, teaching, enterprise product development and internal quality control purposes.
8. The quality system of our laboratory is in accordance with ISO/IEC17025.
9. If there is any objection to this test report, the client should inform issuing laboratory within 15 days from the date of receiving test report.

Address:

1-2/F., Building B, Pengzhou Industrial Park, No.158, Fuyuan 1st Road, Zhancheng, Fuhai Subdistrict, Bao'an District, Shenzhen, Guangdong, China

TEL: 400-788-9558

P.C.: 518103

FAX: 0755-33229357

Website: <http://www.chnbctc.com>

E-Mail: bctc@bctc-lab.com.cn

***** END *****

CO., LTD.

