



**Shenzhen CTA Testing Technology Co., Ltd.**

Room 106, Building 1, Yibaolai Industrial Park, Qiaotou Community, Fuhai Street, Bao'an District, Shenzhen, China

**FCC PART 15 SUBPART C TEST REPORT**

**FCC PART 15 SUBPART E 15.407**

**Report Reference No.**.....: **CTA23090501102**

**FCC ID**.....: **2ATOW-TD-97X2**

Compiled by  
( position+printed name+signature) .: File administrators Zoey Cao

Supervised by  
( position+printed name+signature) .: Project Engineer Amy Wen

Approved by  
( position+printed name+signature) .: RF Manager Eric Wang

Date of issue .....: Sep. 15, 2023



**Testing Laboratory Name** .....: **Shenzhen CTA Testing Technology Co., Ltd.**

Address.....: Room 106, Building 1, Yibaolai Industrial Park, Qiaotou Community, Fuhai Street, Bao'an District, Shenzhen, China

**Applicant's name**.....: **SHENZHEN TVT DIGITAL TECHNOLOGY CO., LTD.**

Address .....: 23rd Floor, Building B4, Block 9, Shenzhen Bay Science and Technology Ecological Garden, Yuehai Subdistrict, Nanshan District, Shenzhen, P.R. China

**Test specification** .....

Standard.....: **FCC Part 15 Subpart E 15.407**

TRF Originator.....: Shenzhen CTA Testing Technology Co., Ltd.

**Shenzhen CTA Testing Technology Co., Ltd. All rights reserved.**

This publication may be reproduced in whole or in part for non-commercial purposes as long as the Shenzhen CTA Testing Technology Co., Ltd. is acknowledged as copyright owner and source of the material. Shenzhen CTA Testing Technology Co., Ltd. takes no responsibility for and will not assume liability for damages resulting from the reader's interpretation of the reproduced material due to its placement and context.

**Test item description** .....

Trade Mark.....: TVT

Manufacturer .....: SHENZHEN TVT DIGITAL TECHNOLOGY CO., LTD.

Model/Type reference .....: TD-9742A3-PC

Listed Models .....: TD-97v2wxyz, TD-97v2wxyz-ww (v=1-8, A-Z; w=A-Z; x=1-8, A-Z, or blank; y=1-8, A-Z, or blank; z=1-8, A-Z, or blank)

Modulation .....: OFDM

Frequency .....: From 5180MHz-5240MHz, 5745MHz-5825MHz

Ratings .....: DC 12V From Adapter(AC 100-240V 50/60Hz)  
DC 48V From POE Port

Result .....: **PASS**

**Shenzhen CTA Testing Technology Co., Ltd.**

Room 106, Building 1, Yibaolai Industrial Park, Qiaotou Community, Fuhai Street, Bao'an District, Shenzhen, China  
Tel:+86-755 2322 5875 E-mail:cta@cta-test.cn Web:http://www.cta-test.cn

# TEST REPORT

Equipment under Test : Dual-lens People Counting Network Camera

Model /Type : TD-9742A3-PC

Serial Models : TD-97v2wxyz, TD-97v2wxyz-ww (v=1-8, A-Z; w=A-Z; x=1-8, A-Z, or blank; y=1-8, A-Z, or blank; z=1-8, A-Z, or blank)

**Applicant : SHENZHEN TVT DIGITAL TECHNOLOGY CO., LTD.**

Address : 23rd Floor, Building B4, Block 9, Shenzhen Bay Science and Technology Ecological Garden, Yuehai Subdistrict, Nanshan District, Shenzhen, P.R. China

**Manufacturer : SHENZHEN TVT DIGITAL TECHNOLOGY CO., LTD.**

Address : 23rd Floor, Building B4, Block 9, Shenzhen Bay Science and Technology Ecological Garden, Yuehai Subdistrict, Nanshan District, Shenzhen, P.R. China

<b>Test Result:</b>	<b>PASS</b>
---------------------	-------------

The test report merely corresponds to the test sample.  
It is not permitted to copy extracts of these test result without the written permission of the test laboratory.

## Contents

<b>1</b>	<b><u>TEST STANDARDS .....</u></b>	<b><u>4</u></b>
<b>2</b>	<b><u>SUMMARY .....</u></b>	<b><u>5</u></b>
2.1	General Remarks	5
2.2	Product Description	5
2.3	Equipment Under Test	5
2.4	Short description of the Equipment under Test (EUT)	5
2.5	EUT operation mode	6
2.6	Block Diagram of Test Setup	6
2.7	Related Submittal(s) / Grant (s)	6
2.8	Modifications	6
<b>3</b>	<b><u>TEST ENVIRONMENT .....</u></b>	<b><u>7</u></b>
3.1	Address of the test laboratory	7
3.2	Test Facility	7
3.3	Environmental conditions	7
3.4	Test Description	8
3.5	Statement of the measurement uncertainty	8
3.6	Equipments Used during the Test	9
<b>4</b>	<b><u>TEST CONDITIONS AND RESULTS.....</u></b>	<b><u>10</u></b>
4.1	AC Power Conducted Emission	10
4.2	Radiated Emissions	13
4.3	Maximum Conducted Average Output Power	19
4.4	Power Spectral Density	25
4.5	Emission Bandwidth (26dB Bandwidth)	39
4.6	Minimum Emission Bandwidth (6dB Bandwidth)	47
4.7	Frequency Stability	55
<b>5</b>	<b><u>TEST SETUP PHOTOS OF THE EUT .....</u></b>	<b><u>58</u></b>
<b>6</b>	<b><u>PHOTOS OF THE EUT .....</u></b>	<b><u>59</u></b>

# 1 TEST STANDARDS

The tests were performed according to following standards:

[FCC Rules Part 15 Subpart E](#)—Unlicensed National Information Infrastructure Devices

[ANSI C63.10-2013](#): American National Standard for Testing Unlicensed Wireless Devices

[KDB789033 D02](#): General UNII Test Procedures New Rules v01r02

## 2 SUMMARY

### 2.1 General Remarks

Date of receipt of test sample	:	Sep. 05, 2023
Testing commenced on	:	Sep. 05, 2023
Testing concluded on	:	Sep. 15, 2023

### 2.2 Product Description

Product Description:	Dual-lens People Counting Network Camera			
Model:	TD-9742A3-PC			
Power supply:	DC 12V From Adapter(AC 100-240V 50/60Hz) DC 48V From POE Port			
Adapter information (Auxiliary test supplied by test Lab) :	Model: XED-UL120200CC Input: AC 100-240V 50/60Hz Output: DC 12V 2.0A			
testing sample ID:	CTA230905011-1# (Engineer sample) CTA230905011-2# (Normal sample)			
Hardware version:	1.5-1714222			
Software version:	49414			
<b>WIFI</b>				
	20MHz system	40MHz system	80MHz system	160MHz system
Supported type:	802.11a 802.11n 802.11ac	802.11n 802.11ac	802.11ac	N/A
Operation frequency:	5180MHz-5240MHz 5745MHz-5825MHz	5190MHz-5230MHz 5755MHz-5795MHz	5210MHz 5775MHz	N/A
Modulation:	OFDM	OFDM	OFDM	N/A
Channel number:	9	4	2	N/A
Channel separation:	20MHz	40MHz	80MHz	N/A
Antenna type:	PIFA antenna			
Antenna gain:	2.00 dBi for Ant 1 and Ant 2			

### 2.3 Equipment Under Test

#### Power supply system utilised

Power supply voltage	:	<input type="radio"/> 230V / 50 Hz	<input type="radio"/> 120V / 60Hz
		<input type="radio"/> 12V DC	<input type="radio"/> 24V DC
		<input checked="" type="radio"/> Other (specified in blank below)	

DC 12V From Adapter(AC 100-240V 50/60Hz)

DC 48V From POE Port

### 2.4 Short description of the Equipment under Test (EUT)

This is a Dual-lens People Counting Network Camera  
For more details, refer to the user's manual of the EUT.

**Shenzhen CTA Testing Technology Co., Ltd.**

Room 106, Building 1, Yibaolai Industrial Park, Qiaotou Community, Fuhai Street, Bao'an District, Shenzhen, China  
Tel:+86-755 2322 5875 E-mail:cta@cta-test.cn Web:http://www.cta-test.cn

### 2.5 EUT operation mode

The Applicant provides communication tools software (AT command) to control the EUT for staying in continuous transmitting (Duty Cycle more than 98%) and receiving mode for testing. All test performed at the low, middle and high of operational frequency range of each mode.

Operation Frequency List WIFI on 5G Band:

Operating band	20MHz		40MHz		80MHz	
	Channel	Frequency (MHz)	Channel	Frequency (MHz)	Channel	Frequency (MHz)
U-NII 1 (5150MHz-5250MHz)	36	5180	38	5190	42	5210
	40	5200				
	44	5220	46	5230		
	48	5240				
U-NII 3 (5725MHz-5850MHz)	149	5745	151	5755	155	5775
	153	5765	159	5795		
	157	5785				
	161	5805				
	165	5825	--	--		

Note: The line display in grey is those Channels/Frequencies select to test in this report for each operation mode.

### 2.6 Block Diagram of Test Setup

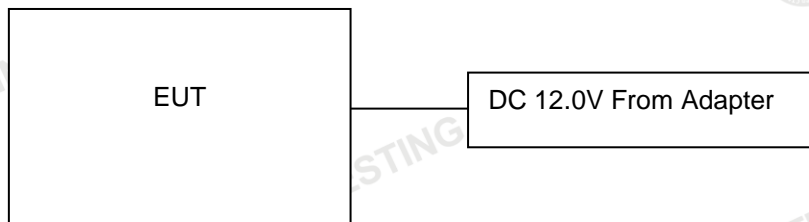

### 2.7 Related Submittal(s) / Grant (s)

This submittal(s) (test report) is intended to comply with Section 15.407 of the FCC Part 15, Subpart E Rules.

### 2.8 Modifications

No modifications were implemented to meet testing criteria.

### 3 TEST ENVIRONMENT

#### 3.1 Address of the test laboratory

**Shenzhen CTA Testing Technology Co., Ltd.**

Room 106, Building 1, Yibaolai Industrial Park, Qiaotou Community, Fuhai Street, Bao'an District, Shenzhen, China

#### 3.2 Test Facility

The test facility is recognized, certified, or accredited by the following organizations:

**FCC-Registration No.: 517856 Designation Number: CN1318**

Shenzhen CTA Testing Technology Co., Ltd. has been listed on the US Federal Communications Commission list of test facilities recognized to perform electromagnetic emissions measurements.

**A2LA-Lab Cert. No.: 6534.01**

Shenzhen CTA Testing Technology Co., Ltd. has been listed by American Association for Laboratory Accreditation to perform electromagnetic emission measurement.

The 3m-Semi anechoic test site fulfils CISPR 16-1-4 according to ANSI C63.10 and CISPR 16-1-4:2010.

#### 3.3 Environmental conditions

During the measurement the environmental conditions were within the listed ranges:

Radiated Emission:

Temperature:	25 ° C
Humidity:	45 %
Atmospheric pressure:	950-1050mbar

Conducted testing:

Temperature:	25 ° C
Humidity:	44 %
Atmospheric pressure:	950-1050mbar

AC Power Conducted Emission

Temperature:	24 ° C
Humidity:	44 %
Atmospheric pressure:	950-1050mbar

### 3.4 Test Description

FCC Requirement		
FCC Part 15.207	AC Power Conducted Emission	PASS
FCC Part 15.407(a)	Emission Bandwidth(26dBm Bandwidth)	PASS <sup>Note1</sup>
FCC Part 15.407(e)	Minimum Emission Bandwidth(6dBm Bandwidth)	PASS <sup>Note2</sup>
FCC Part 15.407(a)	Maximum Conducted Output Power	PASS
FCC Part 15.407(a)	Peak Power Spectral Density	PASS
FCC Part 15.407(g)	Frequency Stability	PASS
FCC Part 15.407(b)	Undesirable emission	PASS
FCC Part 15.407(b)/15.205/15.209	Radiated Emissions	PASS
FCC Part 15.407(h)	Dynamic Frequency Selection	N/A <sup>Note 3</sup>
FCC Part 15.203/15.247(b)	Antenna Requirement	PASS

Note 1: Apply to U-NII 1 band.

Note 2: Apply to U-NII 3 band only.

Note 3: This device not work in DFS band.

Note 4: We tested the EUT with Adapter and POE Adapter, and recorded the worst case at the Adapter.

#### Data Rate Used:

Preliminary tests were performed in different data rate to find the worst radiated emission. The data rate shown in the table below is the worst-case rate with respect to the specific test item. Investigation has been done on all the possible configurations for searching the worst cases. The following table is a list of the test modes shown in this test report.

Test Items	Mode	Data Rate
Maximum Conducted Output Power Power Spectral Density Emission Bandwidth(26dBm Bandwidth) Minimum Emission Bandwidth(6dBm Bandwidth) Undesirable emission Frequency Stability	11a/OFDM	6 Mbps
	11n(20MHz),11ac (20MHz)/OFDM	7.2 Mbps
	11n(40MHz),11ac (40MHz)/OFDM	15.0Mbps
	11ac(80MHz)/OFDM	65.0Mbps

### 3.5 Statement of the measurement uncertainty

The data and results referenced in this document are true and accurate. The reader is cautioned that there may be errors within the calibration limits of the equipment and facilities. The measurement uncertainty was calculated for all measurements listed in this test report acc. to TR-100028-01 "Electromagnetic compatibility and Radio spectrum Matters (ERM);Uncertainties in the measurement of mobile radio equipment characteristics; Part 1" and TR-100028-02 "Electromagnetic compatibility and Radio spectrum Matters (ERM);Uncertainties in the measurement of mobile radio equipment characteristics; Part 2 " and is documented in the Shenzhen CTA Testing Technology Co., Ltd.quality system acc. to DIN EN ISO/IEC 17025. Furthermore, component and process variability of devices similar to that tested may result in additional deviation. The manufacturer has the sole responsibility of continued compliance of the device.

Hereafter the best measurement capability for Shenzhen CTA Testing Technology Co., Ltd.:

Test	Range	Measurement Uncertainty	Notes
Radiated Emission	30~1000MHz	4.06 dB	(1)
Radiated Emission	1~18GHz	5.14 dB	(1)
Radiated Emission	18-40GHz	5.38 dB	(1)
Conducted Disturbance	0.15~30MHz	2.14 dB	(1)

Shenzhen CTA Testing Technology Co., Ltd.

Room 106, Building 1, Yibaolai Industrial Park, Qiaotou Community, Fuhai Street, Bao'an District, Shenzhen, China  
Tel:+86-755 2322 5875 E-mail:cta@cta-test.cn Web:http://www.cta-test.cn



(1) This uncertainty represents an expanded uncertainty expressed at approximately the 95% confidence level using a coverage factor of  $k=2$ .

### 3.6 Equipments Used during the Test

Test Equipment	Manufacturer	Model No.	Equipment No.	Calibration Date	Calibration Due Date
LISN	R&S	ENV216	CTA-308	2023/08/02	2024/08/01
LISN	R&S	ENV216	CTA-314	2023/08/02	2024/08/01
EMI Test Receiver	R&S	ESPI	CTA-307	2023/08/02	2024/08/01
EMI Test Receiver	R&S	ESCI	CTA-306	2023/08/02	2024/08/01
Spectrum Analyzer	Agilent	N9020A	CTA-301	2023/08/02	2024/08/01
Spectrum Analyzer	R&S	FSP	CTA-337	2023/08/02	2024/08/01
Vector Signal generator	Agilent	N5182A	CTA-305	2023/08/02	2024/08/01
Analog Signal Generator	R&S	SML03	CTA-304	2023/08/02	2024/08/01
Universal Radio Communication	CMW500	R&S	CTA-302	2023/08/02	2024/08/01
Temperature and humidity meter	Chigo	ZG-7020	CTA-326	2023/08/02	2024/08/01
Ultra-Broadband Antenna	Schwarzbeck	VULB9163	CTA-310	2021/08/07	2024/08/06
Horn Antenna	Schwarzbeck	BBHA 9120D	CTA-309	2021/08/07	2024/08/06
Loop Antenna	Zhinan	ZN30900C	CTA-311	2021/08/07	2024/08/06
Horn Antenna	Beijing Hangwei Dayang	OBH100400	CTA-336	2021/08/07	2024/08/06
Amplifier	Schwarzbeck	BBV 9745	CTA-312	2023/08/02	2024/08/01
Amplifier	Taiwan chengyi	EMC051845B	CTA-313	2023/08/02	2024/08/01
Directional coupler	NARDA	4226-10	CTA-303	2023/08/02	2024/08/01
High-Pass Filter	XingBo	XBLBQ-GTA18	CTA-402	2023/08/02	2024/08/01
High-Pass Filter	XingBo	XBLBQ-GTA27	CTA-403	2023/08/02	2024/08/01
Automated filter bank	Tonscend	JS0806-F	CTA-404	2023/08/02	2024/08/01
Power Sensor	Agilent	U2021XA	CTA-405	2023/08/02	2024/08/01
Amplifier	Schwarzbeck	BBV9719	CTA-406	2023/08/02	2024/08/01

## 4 TEST CONDITIONS AND RESULTS

### 4.1 AC Power Conducted Emission

#### TEST CONFIGURATION

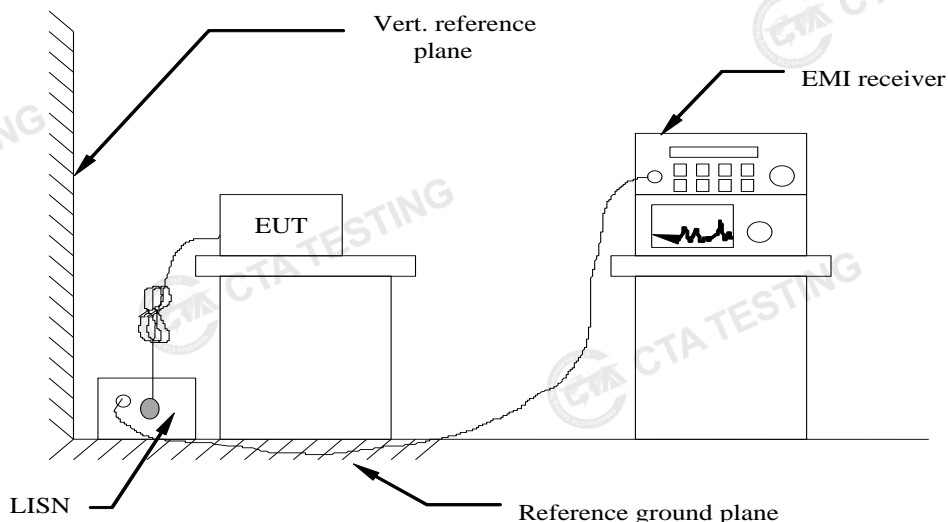

#### TEST PROCEDURE

- 1 The equipment was set up as per the test configuration to simulate typical actual usage per the user's manual. The EUT is a tabletop system, a wooden table with a height of 0.8 meters is used and is placed on the ground plane as per ANSI C63.10-2013.
- 2 Support equipment, if needed, was placed as per ANSI C63.10-2013
- 3 All I/O cables were positioned to simulate typical actual usage as per ANSI C63.10-2013
- 4 The EUT received power from adapter, the adapter received AC120V/60Hz and AC 240V/60Hz power through a Line Impedance Stabilization Network (LISN) which supplied power source and was grounded to the ground plane.
- 5 All support equipments received AC power from a second LISN, if any.
- 6 The EUT test program was started. Emissions were measured on each current carrying line of the EUT using a spectrum Analyzer / Receiver connected to the LISN powering the EUT. The LISN has two monitoring points: Line 1 (Hot Side) and Line 2 (Neutral Side). Two scans were taken: one with Line 1 connected to Analyzer / Receiver and Line 2 connected to a 50 ohm load; the second scan had Line 1 connected to a 50 ohm load and Line 2 connected to the Analyzer / Receiver.
- 7 Analyzer / Receiver scanned from 150 KHz to 30MHz for emissions in each of the test modes.
- 8 During the above scans, the emissions were maximized by cable manipulation.

#### AC Power Conducted Emission Limit

For intentional device, according to § 15.207(a) AC Power Conducted Emission Limits is as following :

Frequency range (MHz)	Limit (dBuV)	
	Quasi-peak	Average
0.15-0.5	66 to 56*	56 to 46*
0.5-5	56	46
5-30	60	50

\* Decreases with the logarithm of the frequency.

**TEST RESULTS**

Remark:

1. All modes of 802.11a/n were tested at Low, Middle, and High channel; only the worst result of 802.11a CH36 was reported as below:
2. Both 120 VAC, 50/60 Hz and 240 VAC, 50/60 Hz power supply have been tested, only the worst result of 120 VAC, 60 Hz was reported as below:

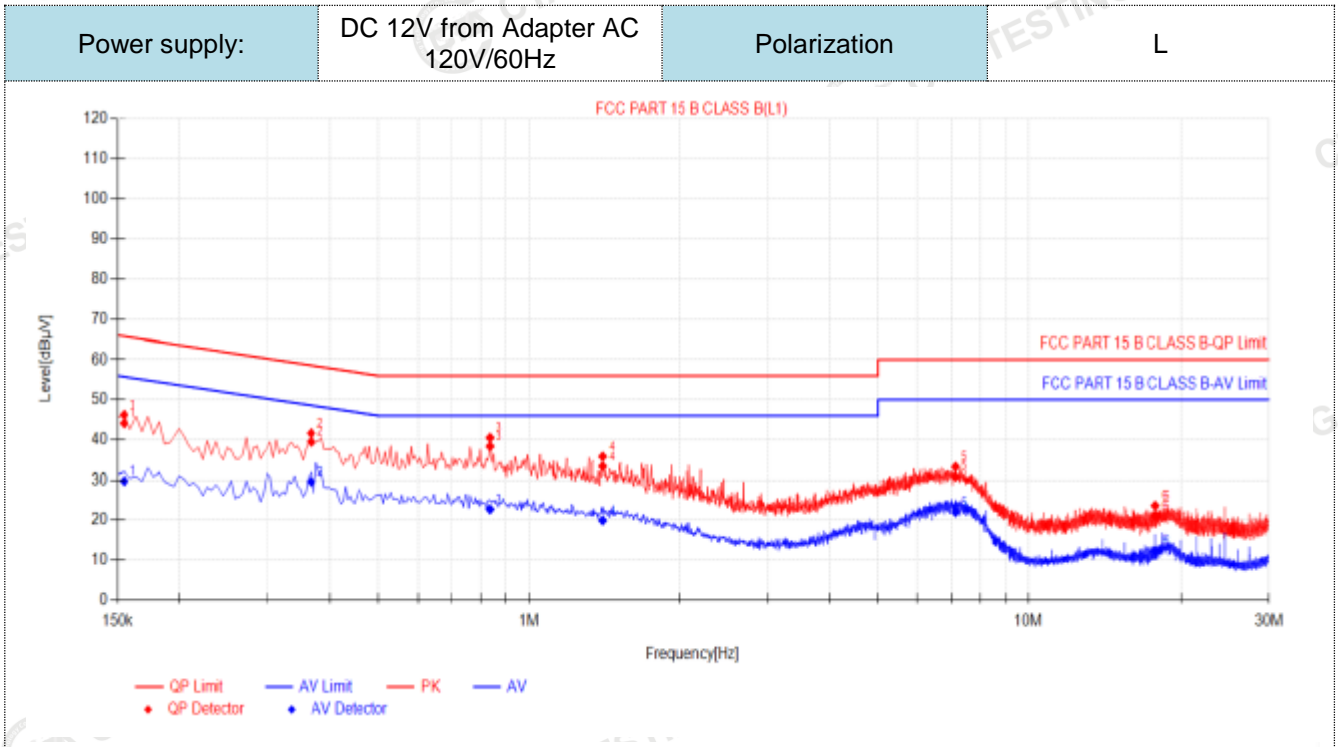

**Final Data List**

NO.	Freq. [MHz]	Factor [dB]	QP Reading[dB µV]	QP Value [dBµV]	QP Limit [dBµV]	QP Margin [dB]	AV Reading [dBµV]	AV Value [dBµV]	AV Limit [dBµV]	AV Margin [dB]	Verdict
1	0.1545	10.50	33.58	44.08	65.75	21.67	19.28	29.76	55.75	25.99	PASS
2	0.386	10.50	28.97	39.47	58.59	19.12	19.11	29.61	48.59	18.98	PASS
3	0.834	10.50	27.84	38.34	56.00	17.66	12.24	22.74	46.00	23.26	PASS
4	1.4055	10.50	22.85	33.35	56.00	22.65	9.45	19.95	46.00	26.05	PASS
5	7.1295	10.50	20.39	30.89	60.00	29.11	11.52	22.02	50.00	27.98	PASS
6	17.9475	10.50	10.69	21.19	60.00	38.81	1.89	12.39	50.00	37.61	PASS

Note:1).QP Value (dBµV)= QP Reading (dBµV)+ Factor (dB)

2). Factor (dB)=insertion loss of LISN (dB) + Cable loss (dB)

3). QPMargin(dB) = QP Limit (dBµV) - QP Value (dBµV)

4). AVMargin(dB) = AV Limit (dBµV) - AV Value (dBµV)

Power supply:	DC 12V from Adapter AC 120V/60Hz	Polarization	N
---------------	----------------------------------	--------------	---

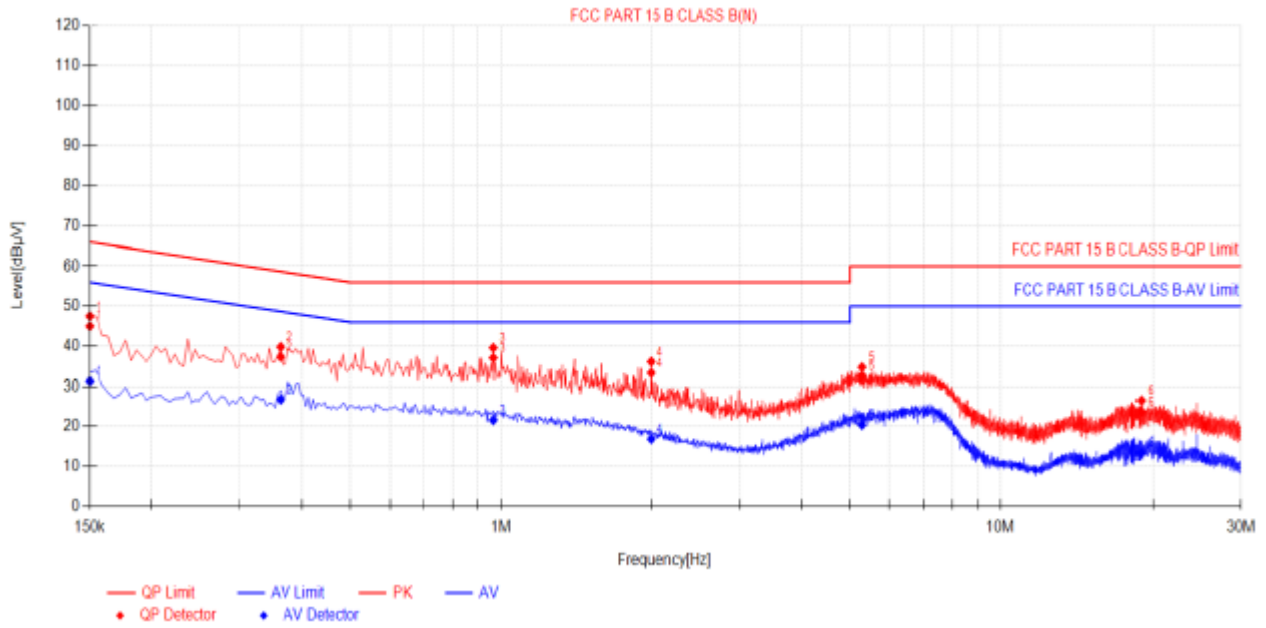

Final Data List

NO.	Freq. [MHz]	Factor [dB]	QP Reading [dB µV]	QP Value [dBµV]	QP Limit [dBµV]	QP Margin [dB]	AV Reading [dBµV]	AV Value [dBµV]	AV Limit [dBµV]	AV Margin [dB]	Verdict
1	0.15	10.50	34.50	45.00	66.00	21.00	20.82	31.32	56.00	24.68	PASS
2	0.3615	10.50	26.80	37.30	58.69	21.39	16.26	26.76	48.69	21.93	PASS
3	0.9645	10.50	26.57	37.07	56.00	18.93	11.12	21.62	46.00	24.38	PASS
4	1.995	10.50	22.83	33.33	56.00	22.67	6.39	16.89	46.00	29.11	PASS
5	5.28	10.50	22.14	32.64	60.00	27.36	9.92	20.42	50.00	29.58	PASS
6	18.987	10.50	13.20	23.70	60.00	36.30	2.84	13.34	50.00	36.66	PASS

- Note: 1). QP Value (dBµV) = QP Reading (dBµV) + Factor (dB)  
 2). Factor (dB) = insertion loss of LISN (dB) + Cable loss (dB)  
 3). QPMargin (dB) = QP Limit (dBµV) - QP Value (dBµV)  
 4). AVMargin (dB) = AV Limit (dBµV) - AV Value (dBµV)

## 4.2 Radiated Emissions

### Limit

The maximum emissions outside of the frequency bands of operation shall be attenuated in accordance with the following limits:

- (1) For transmitters operating in the 5.15-5.25 GHz band: All emissions outside of the 5.15-5.35 GHz band shall not exceed an e.i.r.p. of -27 dBm/MHz.
- (2) For transmitters operating in the 5.25-5.35 GHz band: All emissions outside of the 5.15-5.35 GHz band shall not exceed an e.i.r.p. of -27 dBm/MHz.
- (3) For transmitters operating in the 5.47-5.725 GHz band: All emissions outside of the 5.47-5.725 GHz band shall not exceed an e.i.r.p. of -27 dBm/MHz.
- (4) For transmitters operating in the 5.725-5.85 GHz band: All emissions shall be limited to a level of -27 dBm/MHz at 75 MHz or more above or below the band edge increasing linearly to 10 dBm/MHz at 25 MHz above or below the band edge, and from 25 MHz above or below the band edge increasing linearly to a level of 15.6 dBm/MHz at 5 MHz above or below the band edge, and from 5 MHz above or below the band edge increasing linearly to a level of 27 dBm/MHz at the band edge.

### Undesirable emission limits

Requirement	Limit(EIRP)	Limit (Field strength at 3m) <small>Note1</small>
15.407(b)(1)	PK:-27(dBm/MHz)	PK:68.2(dBμV/m)
15.407(b)(2)		
15.407(b)(3)		
15.407(b)(4)		

Note1: The following formula is used to convert the equipment isotropic radiated power (eirp) to field strength:

$$E = \frac{1000000\sqrt{30P}}{3} \mu\text{V/m, where P is the eirp (Watts)}$$

- (5) Unwanted emissions below 1 GHz must comply with the general field strength limits set forth in §15.209
- (6) In addition, radiated emissions which fall in the restricted bands, as defined in §15.205(a), must also comply with the radiated emission limits specified in §15.209(a)

### Radiated emission limits

Frequency (MHz)	Distance (Meters)	Radiated (dBμV/m)	Radiated (μV/m)
0.009-0.49	3	20log(2400/F(KHz))+40log(300/3)	2400/F(KHz)
0.49-1.705	3	20log(24000/F(KHz))+ 40log(30/3)	24000/F(KHz)
1.705-30	3	20log(30)+ 40log(30/3)	30
30-88	3	40.0	100
88-216	3	43.5	150
216-960	3	46.0	200
Above 960	3	54.0	500

**TEST CONFIGURATION**

(A) Radiated Emission Test Set-Up, Frequency Below 30MHz

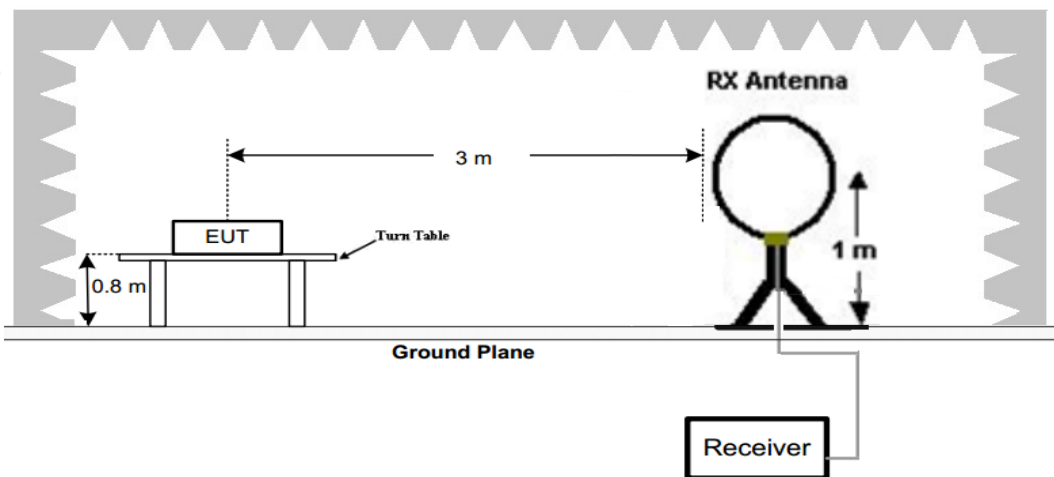

(B) Radiated Emission Test Set-Up, Frequency below 1000MHz

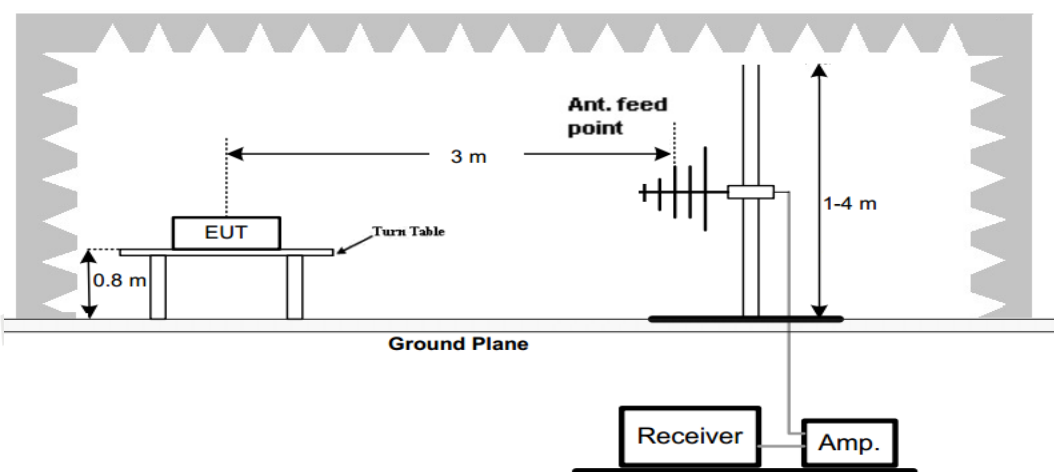

(C) Radiated Emission Test Set-Up, Frequency above 1000MHz

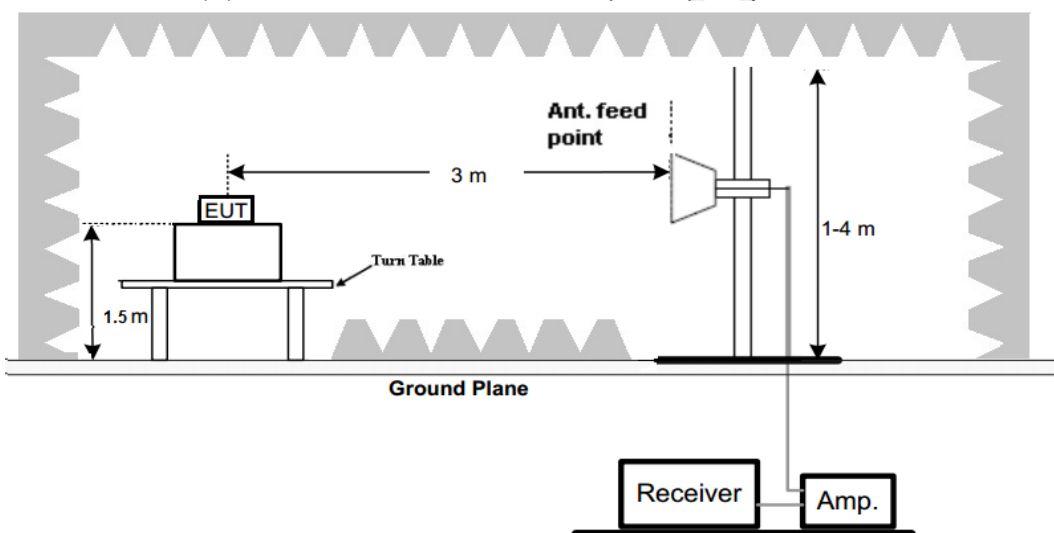

**Test Procedure**

- Below 1GHz measurement the EUT is placed on a turntable which is 0.8m above ground plane, and above 1GHz measurement EUT was placed on a low permittivity and low loss tangent turn table which is 1.5m above ground plane.
- Maximum procedure was performed by raising the receiving antenna from 1m to 4m and rotating the turn table from 0° to 360° to acquire the highest emissions from EUT
- And also, each emission was to be maximized by changing the polarization of receiving antenna both horizontal and vertical.
- Repeat above procedures until all frequency measurements have been completed.
- Radiated emission test frequency band from 9KHz to 40GHz.
- The distance between test antenna and EUT as following table states:

Test Frequency range	Test Antenna Type	Test Distance
9KHz-30MHz	Active Loop Antenna	3
30MHz-1GHz	Bilog Antenna	3
1GHz-18GHz	Horn Antenna	3
18GHz-25GHz	Horn Antenna	1

- Setting test receiver/spectrum as following table states:

Test Frequency range	Test Receiver/Spectrum Setting	Detector
9KHz-150KHz	RBW=200Hz/VBW=3KHz,Sweep time=Auto	QP
150KHz-30MHz	RBW=9KHz/VBW=100KHz,Sweep time=Auto	QP
30MHz-1GHz	RBW=120KHz/VBW=1000KHz,Sweep time=Auto	QP
1GHz-40GHz	Peak Value: RBW=1MHz/VBW=3MHz, Sweep time=Auto Average Value: RBW=1MHz/VBW=10Hz, Sweep time=Auto	Peak

**TEST RESULTS**

Remark:

- This test was performed with EUT in X, Y, Z position and the worse case was found when EUT in X position.
- All 802.11a / 802.11n (HT20) / 802.11n (HT40) /ac (HT80) modes have been tested for below 1GHz test, only the worst case 802.11a low channel of U-NII 1 band was recorded.
- All 802.11a / 802.11n (HT20) / 802.11n (HT40) /ac (HT80)modes have been tested for above 1GHz test, only the worst case 802.11a was recorded.
- Radiated emission test from 9 KHz to 10th harmonic of fundamental was verified, and no emission found except system noise floor in 9 KHz to 30MHz and not recorded in this report.

For 30MHz-1GHz

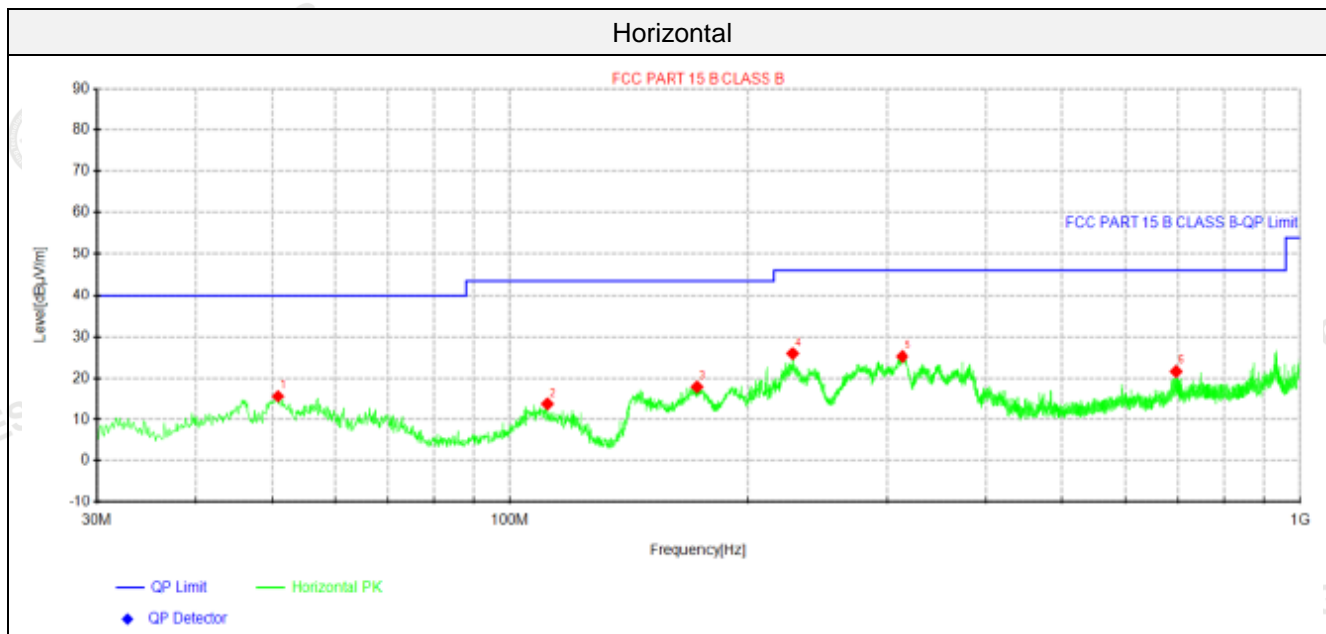

Suspected Data List									
NO.	Freq. [MHz]	Reading [dBµV]	Level [dBµV/m]	Factor [dB/m]	Limit [dBµV/m]	Margin [dB]	Height [cm]	Angle [°]	Polarity
1	50.855	31.85	15.60	-16.25	40.00	24.40	100	307	Horizontal
2	111.601	32.75	13.67	-19.08	43.50	29.83	100	257	Horizontal
3	172.468	38.85	17.93	-20.92	43.50	25.57	100	266	Horizontal
4	227.88	44.40	25.86	-18.54	46.00	20.14	100	42	Horizontal
5	313.603	42.24	25.14	-17.10	46.00	20.86	100	282	Horizontal
6	696.026	33.37	21.59	-11.78	46.00	24.41	100	222	Horizontal

Note:1).Level (dBµV/m)= Reading (dBµV)+ Factor (dB/m)

2). Factor(dB/m)=Antenna Factor (dB/m) + Cable loss (dB) - Pre Amplifier gain (dB)

3). Margin(dB) = Limit (dBµV/m) - Level (dBµV/m)



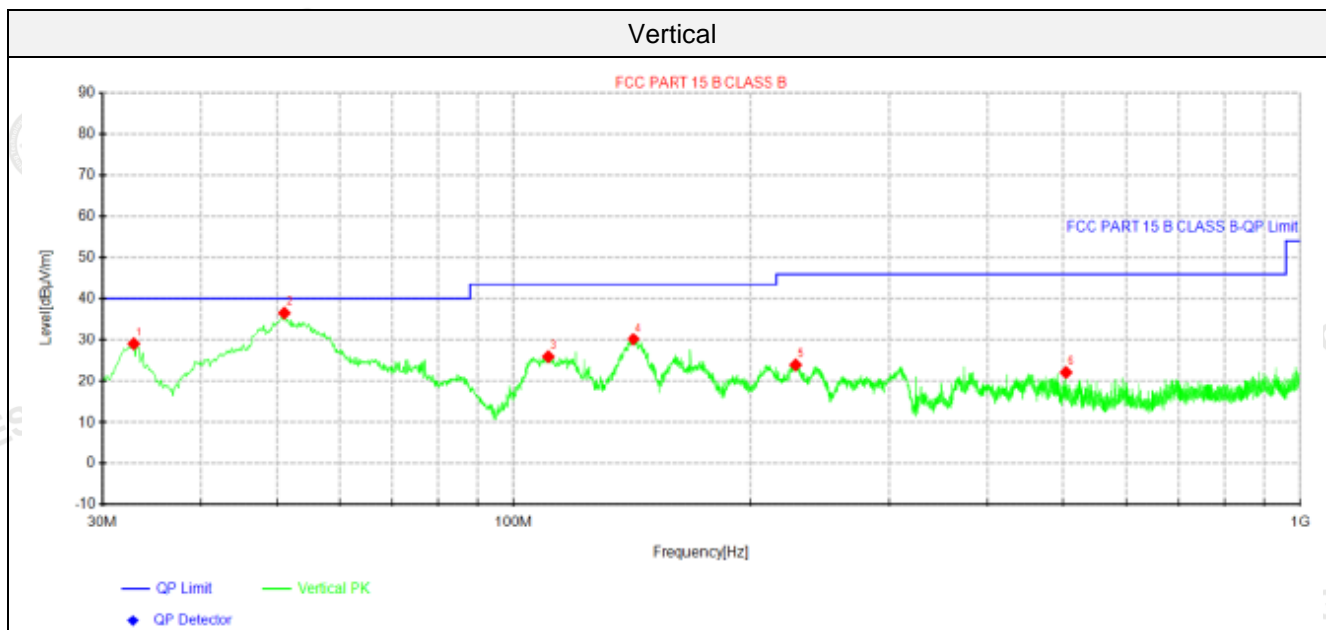

Suspected Data List									
NO.	Freq. [MHz]	Reading [dBμV]	Level [dBμV/m]	Factor [dB/m]	Limit [dBμV/m]	Margin [dB]	Height [cm]	Angle [°]	Polarity
1	32.91	47.22	28.99	-18.23	40.00	11.01	100	26	Vertical
2	51.0975	52.83	36.53	-16.30	40.00	3.47	100	299	Vertical
3	110.752	44.86	25.91	-18.95	43.50	17.59	100	146	Vertical
4	142.035	51.90	30.12	-21.78	43.50	13.38	100	60	Vertical
5	228.243	42.47	23.94	-18.53	46.00	22.06	100	136	Vertical
6	503.966	36.39	22.15	-14.24	46.00	23.85	100	146	Vertical

- Note:1). Level (dBμV/m)= Reading (dBμV)+ Factor (dB/m)  
 2). Factor(dB/m)=Antenna Factor (dB/m) + Cable loss (dB) - Pre Amplifier gain (dB)  
 3). Margin(dB) = Limit (dBμV/m) - Level (dBμV/m)

**For 1GHz to 40GHz**

Note: All 802.11a / 802.11n/ac (HT20) /802.11n/ac (HT40)/ac (HT80) modes have been tested for above 1GHz test, only the worst case 802.11a was recorded.

**U-NII 1 & 802.11a Mode (above 1GHz)**

Tested Channel	Frequency (MHz)	Emission Level (dBuV/m)	Detector Mode	ANT Pol	Limit (dBuV/m)	Margin (dB)	Raw Value (dBuV)	Antenna Factor (dB/m)	Cable Factor (dB)	Pre amplifier (dB)	Correction Factor (dB/m)
36.00 (5180MHz)	5150.00	56.16	PK	H	68.20	12.04	59.59	33.04	5.45	41.92	-3.43
	5150.00	46.32	AV	H	54.00	7.68	49.75	33.04	5.45	41.92	-3.43
	10360.00	51.56	PK	H	68.20	16.64	38.83	38.83	10.12	45.28	3.67
	--	--	--	--	--	--	--	--	--	--	--
44.00 (5220MHz)	10440.00	51.63	PK	H	68.20	16.57	47.95	38.85	10.13	45.3	3.68
	--	--	--	--	--	--	--	--	--	--	--
48.00 (5240MHz)	5350.50	47.35	PK	H	68.20	20.85	50.62	32.84	5.97	42.08	-3.27
	10480.00	51.27	PK	H	68.20	16.93	47.53	38.89	10.19	45.34	3.74
	--	--	--	--	--	--	--	--	--	--	--

Tested Channel	Frequency (MHz)	Emission Level (dBuV/m)	Detector Mode	ANT Pol	Limit (dBuV/m)	Margin (dB)	Raw Value (dBuV)	Antenna Factor (dB/m)	Cable Factor (dB)	Pre amplifier (dB)	Correction Factor (dB/m)
36.00 (5180MHz)	5150.00	55.07	PK	V	68.20	13.13	58.50	33.04	5.45	41.92	-3.43
	5150.00	46.52	AV	V	54.00	7.48	49.95	33.04	5.45	41.92	-3.43
	10360.00	51.61	PK	V	68.20	16.59	47.94	38.83	10.12	45.28	3.67
	--	--	--	--	--	--	--	--	--	--	--
44.00 (5220MHz)	10440.00	51.83	PK	V	68.20	16.37	48.15	38.85	10.13	45.3	3.68
	--	--	--	--	--	--	--	--	--	--	--
48.00 (5240MHz)	5350.50	49.92	PK	V	68.20	18.28	53.19	32.84	5.97	42.08	-3.27
	10480.00	51.71	PK	V	68.20	16.49	47.97	38.89	10.19	45.34	3.74
	--	--	--	--	--	--	--	--	--	--	--

**U-NII 3 & 802.11a Mode (above 1GHz)**

Tested Channel	Frequency (MHz)	Emission Level (dBuV/m)	Detector Mode	ANT Pol	Limit (dBuV/m)	Margin (dB)	Raw Value (dBuV)	Antenna Factor (dB/m)	Cable Factor (dB)	Pre amplifier (dB)	Correction Factor (dB/m)
	5720.00	55.27	PK	H	68.20	12.93	58.05	33.42	6.04	42.24	-2.78
149.00 (5745MHz)	5720.00	47.30	AV	H	54.00	6.70	50.08	33.42	6.04	42.24	-2.78
	11490.00	50.78	PK	H	68.20	17.42	46.30	39.02	10.91	45.45	4.48
	--	--	--	--	--	--	--	--	--	--	--
157.00 (5785MHz)	11570.00	51.95	PK	H	68.20	16.25	47.50	38.93	10.95	45.43	4.45
	--	--	--	--	--	--	--	--	--	--	--
48.00 (5825MHz)	5855.00	50.27	PK	H	68.20	17.93	52.46	33.91	6.17	42.27	-2.19
	11650.00	50.87	PK	H	68.20	17.33	46.29	38.83	11.16	45.41	4.58
	--	--	--	--	--	--	--	--	--	--	--

Tested Channel	Frequency (MHz)	Emission Level (dBuV/m)	Detector Mode	ANT Pol	Limit (dBuV/m)	Margin (dB)	Raw Value (dBuV)	Antenna Factor (dB/m)	Cable Factor (dB)	Pre amplifier (dB)	Correction Factor (dB/m)
	5720.00	54.93	PK	V	68.20	13.27	57.71	33.42	6.04	42.24	-2.78
149.00 (5745MHz)	5720.00	46.42	AV	V	54.00	7.58	49.20	33.42	6.04	42.24	-2.78
	11490.00	50.63	PK	V	68.20	17.57	46.15	39.02	10.91	45.45	4.48
	--	--	--	--	--	--	--	--	--	--	--
157.00 (5785MHz)	11570.00	51.55	PK	V	68.20	16.65	47.10	38.93	10.95	45.43	4.45
	--	--	--	--	--	--	--	--	--	--	--
48.00 (5825MHz)	5855.00	50.07	PK	V	68.20	18.13	52.26	33.91	6.17	42.27	-2.19
	11650.00	50.22	PK	V	68.20	17.98	45.64	38.83	11.16	45.41	4.58
	--	--	--	--	--	--	--	--	--	--	--

- REMARKS:1. Emission level (dBuV/m) =Raw Value (dBuV)+Correction Factor (dB/m)  
 2. Correction Factor (dB/m) = Antenna Factor (dB/m)+Cable Factor (dB)-Pre-amplifier Factor  
 3. Margin value = Limit value- Emission level.  
 4. -- Mean the other emission levels were very low against the limit.  
 5. RBW1MHz VBW3MHz Peak detector is for PK value; RBW 1MHz VBW10Hz Peak detector is for AV value.  
 6. Worst case data at 6Mbps at IEEE 802.11a; MCS0 at IEEE 802.11n HT20, IEEE 802.11n HT40, IEEE 802.11ac VHT20 ,IEEE 802.11ac VHT40 and IEEE 802.11ac VHT80;

### 4.3 Maximum Conducted Average Output Power

#### Limit

##### **For the band 5.15-5.25 GHz.**

(i) For an outdoor access point operating in the band 5.15-5.25 GHz, the maximum conducted output power over the frequency band of operation shall not exceed 1 W provided the maximum antenna gain does not exceed 6 dBi.

(ii) For an indoor access point operating in the band 5.15-5.25 GHz, the maximum conducted output power over the frequency band of operation shall not exceed 1 W provided the maximum antenna gain does not exceed 6 dBi.

(iii) For fixed point-to-point access points operating in the band 5.15-5.25 GHz, the maximum conducted output power over the frequency band of operation shall not exceed 1 W.

(iv) For client devices in the 5.15-5.25 GHz band, the maximum conducted output power over the frequency band of operation shall not exceed 250 mW provided the maximum antenna gain does not exceed 6 dBi.

**For the 5.25-5.35 GHz and 5.47-5.725 GHz bands**, the maximum conducted output power over the frequency bands of operation shall not exceed the lesser of 250 mW or  $11 \text{ dBm} + 10 \log B$ , where B is the 26 dB emission bandwidth in megahertz.

**For the band 5.725-5.85 GHz**, the maximum conducted output power over the frequency band of operation shall not exceed 1 W

#### Test Procedure

Remove the antenna from the EUT and then connect a low loss RF cable from the antenna port to the power sensor.

#### Test Configuration



**Test Results****U-NII 1****ANT 1**

Type	Channel	Output power (dBm)	Limit (dBm)	Result
802.11a	36	10.63	24.0	Pass
	44	10.74		
	48	12.81		
802.11n(HT20)	36	10.28	24.0	Pass
	44	11.01		
	48	11.25		
802.11n(HT40)	38	9.96	24.0	Pass
	46	11.12		
802.11ac(HT20)	36	10.27	24.0	Pass
	44	10.62		
	48	11.63		
802.11ac(HT40)	38	9.59	24.0	Pass
	46	10.11		
802.11ac(HT80)	42	10.78	24.0	Pass

## ANT 2

Type	Channel	Output power (dBm)	Limit (dBm)	Result
802.11a	36	10.36	24.0	Pass
	44	10.68		
	48	11.59		
802.11n(HT20)	36	10.28	24.0	Pass
	44	10.98		
	48	11.62		
802.11n(HT40)	38	9.52	24.0	Pass
	46	10.79		
802.11ac(HT20)	36	10.61	24.0	Pass
	44	11.63		
	48	12.57		
802.11ac(HT40)	38	9.46	24.0	Pass
	46	10.68		
802.11ac(HT80)	42	10.42	24.0	Pass

## U-NII 3

## ANT 1

Type	Channel	Output power (dBm)	Limit (dBm)	Result
802.11a	149	13.14	30.00	Pass
	157	13.33		
	165	13.13		
802.11n(HT20)	149	12.21	30.00	Pass
	157	12.29		
	165	12.02		
802.11n(HT40)	151	11.58	30.00	Pass
	159	11.41		
802.11ac(HT20)	149	11.88	30.00	Pass
	157	12.38		
	165	12.06		
802.11ac(HT40)	151	11.56	30.00	Pass
	159	12.05		
802.11ac(HT80)	155	12.55	30.00	Pass

## ANT 2

Type	Channel	Output power (dBm)	Limit (dBm)	Result
802.11a	149	12.45	30.00	Pass
	157	13.38		
	165	13.16		
802.11n(HT20)	149	12.56	30.00	Pass
	157	13.66		
	165	13.31		
802.11n(HT40)	151	11.03	30.00	Pass
	159	11.51		
802.11ac(HT20)	149	11.33	30.00	Pass
	157	13.65		
	165	13.21		
802.11ac(HT40)	151	11.01	30.00	Pass
	159	12.10		
802.11ac(HT80)	155	12.86	30.00	Pass

For MIMO:

## U-NII 1

Type	Channel	Output power (dBm) ANT1	Output power (dBm) ANT2	Output power (dBm) MIMO	Limit (dBm)	Result
802.11n(HT20)	36	10.28	10.28	13.29	24.0	Pass
	44	11.01	10.98	14.01		
	48	11.25	11.62	14.45		
802.11n(HT40)	38	9.96	9.52	12.76	24.0	Pass
	46	11.12	10.79	13.97		
802.11ac(HT20)	36	10.27	10.61	13.45	24.0	Pass
	44	10.62	11.63	14.16		
	48	11.63	12.57	15.14		
802.11ac(HT40)	38	9.59	9.46	12.54	24.0	Pass
	46	10.11	10.68	13.41		
802.11ac(HT80)	42	10.78	10.42	13.61	24.0	Pass

## U-NII 3

Type	Channel	Output power (dBm) ANT1	Output power (dBm) ANT2	Output power (dBm) MIMO	Limit (dBm)	Result
802.11n(HT20)	149	12.21	12.56	15.40	30.0	Pass
	157	12.29	13.66	16.04		
	165	12.02	13.31	15.72		
802.11n(HT40)	151	11.58	11.03	14.32	30.0	Pass
	159	11.41	11.51	14.47		
802.11ac(HT20)	149	11.88	11.33	14.62	30.0	Pass
	157	12.38	13.65	16.07		
	165	12.06	13.21	15.68		
802.11ac(HT40)	151	11.56	11.01	14.30	30.0	Pass
	159	12.05	12.10	15.09		
802.11ac(HT80)	155	12.55	12.86	15.72	30.0	Pass



#### 4.4 Power Spectral Density

##### Limit

(1) For the band 5.15 - 5.25 GHz.

(i) For an outdoor access point operating in the band 5.15 - 5.25 GHz, the maximum power spectral density shall not exceed 17 dBm in any 1 MHz band. <sup>note1</sup>

(ii) For an indoor access point operating in the band 5.15 - 5.25 GHz, the maximum power spectral density shall not exceed 17 dBm in any 1 MHz band. <sup>note1</sup>

(iii) For fixed point-to-point access points operating in the band 5.15 - 5.25 GHz, transmitters that employ a directional antenna gain greater than 23 dBi, a 1 dB reduction in maximum power spectral density is required for each 1 dB of antenna gain in excess of 23 dBi.

(iv) For mobile and portable client devices in the 5.15 - 5.25 GHz band, the maximum power spectral density shall not exceed 11 dBm in any 1 MHz band. <sup>note1</sup>

(2) For the 5.25 - 5.35 GHz and 5.47 - 5.725 GHz bands, the peak power spectral density shall not exceed 11 dBm in any 1 MHz band. <sup>note1</sup>

(3) For the band 5.725 - 5.85 GHz, the maximum power spectral density shall not exceed 30 dBm in any 500 kHz band. <sup>note1, note2</sup>

Note1: If transmitting antennas of directional gain greater than 6 dBi are used, the peak power spectral density shall be reduced by the amount in dB that the directional gain of the antenna exceeds 6 dBi.

Note2: Fixed point - to-point U-NII devices operating in this band may employ transmitting antennas with directional gain greater than 6 dBi without any corresponding reduction in transmitter conducted power. Fixed, point-to-point operations exclude the use of point-to-multipoint systems, omnidirectional applications, and multiple collocated transmitters transmitting the same information.

##### Test Procedure

1. Use this procedure when the maximum peak conducted output power in the fundamental emission is used to demonstrate compliance.
2. Set the RBW = 1MHz for U-NII 1, U-NII 2A, U-NII C band and 510KHz for U-NII 3 band.
3. Set the VBW  $\geq 3 \times$  RBW.
4. Set the span to encompass the entire EBW.
5. Detector = peak.
6. Sweep time = auto couple.
7. Trace mode = max hold.
8. Allow trace to fully stabilize.
9. Use the peak marker function to determine the maximum power level.

##### Test Configuration

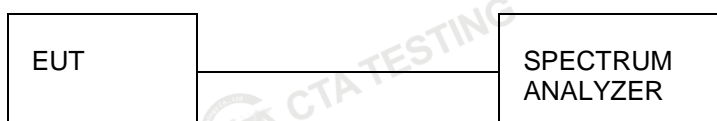

**Test Results****ANT 1**

## U-NII 1

Type	Bands	Channel	Power Spectral Density (dBm/MHz)	Limit (dBm/MHz)	Result
802.11a	U-NII 1	36	-0.45	11.0	Pass
		44	-0.73		
		48	1.44		
802.11n (HT20)	U-NII 1	36	-1.15		
		44	-0.73		
		48	-0.40		
802.11n (HT40)	U-NII 1	38	-3.45		
		46	-3.52		
802.11ac (HT20)	U-NII 1	36	-1.18		
		44	-1.08		
		48	-0.05		
802.11ac (HT40)	U-NII 1	38	-4.72		
		46	-4.00		
802.11ac (HT80)	U-NII 1	42	-5.50		

## U-NII 3

Type	Bands	Channel	Power Spectral Density (dBm/300KHz)	Power Spectral Density (dBm/500KHz)	Limit (dBm/500KHz)	Result
802.11a	U-NII 3	149	-0.44	1.78	30.0	Pass
		157	-0.12	2.10		
		165	-0.01	2.21		
802.11n (HT20)	U-NII 3	149	-1.07	1.15		
		157	-0.90	1.32		
		165	-1.49	0.73		
802.11n (HT40)	U-NII 3	151	-4.51	-2.29		
		159	-4.25	-2.03		
802.11ac (HT20)	U-NII 3	149	-1.64	0.58		
		157	-0.73	1.49		
		165	-1.28	0.94		
802.11ac (HT40)	U-NII 3	151	-4.07	-1.85		
		159	-3.93	-1.71		
802.11ac (HT80)	U-NII 3	155	-5.52	-3.30		

Remark: P.S.D(dBm/500KHz)= P.S.D(dBm/300KHz)+10 log (500 kHz/300KHz).

## ANT 2

## U-NII 1

Type	Bands	Channel	Power Spectral Density (dBm/MHz)	Limit (dBm/MHz)	Result
802.11a	U-NII 1	36	-0.86	11.0	Pass
		44	-0.53		
		48	0.14		
802.11n (HT20)	U-NII 1	36	-1.18		
		44	-0.4		
		48	0.09		
802.11n (HT40)	U-NII 1	38	-4.28		
		46	-3.66		
802.11ac (HT20)	U-NII 1	36	-0.1		
		44	-0.87		
		48	0.19		
802.11ac (HT40)	U-NII 1	38	-4.69		
		46	-3.78		
802.11ac (HT80)	U-NII 1	42	-6.19		

## U-NII 3

Type	Bands	Channel	Power Spectral Density (dBm/300KHz)	Power Spectral Density (dBm/500KHz)	Limit (dBm/500KHz)	Result
802.11a	U-NII 3	149	-0.74	1.48	30.0	Pass
		157	-0.16	2.06		
		165	-0.14	2.08		
802.11n (HT20)	U-NII 3	149	-0.84	1.38		
		157	0.39	2.61		
		165	-0.26	1.96		
802.11n (HT40)	U-NII 3	151	-4.91	-2.69		
		159	-4.01	-1.79		
802.11ac (HT20)	U-NII 3	149	-0.87	1.35		
		157	0.52	2.74		
		165	-0.18	2.04		
802.11ac (HT40)	U-NII 3	151	-4.38	-2.16		
		159	-3.69	-1.47		
802.11ac (HT80)	U-NII 1	155	-4.75	-2.53		

Remark: P.S.D(dBm/500KHz)= P.S.D(dBm/300KHz)+10 log (500 kHz/300KHz).

For MIMO:

## U-NII 1

Type	Channel	Power Spectral Density ANT1	Power Spectral Density ANT2	Power Spectral Density MIMO	Limit (dBm)	Result
802.11n(HT20)	36	-1.15	-1.18	1.85	11.0	PASS
	44	-0.73	-0.4	2.45		
	48	-0.4	0.09	2.86		
802.11n(HT40)	38	-3.45	-4.28	-0.83		
	46	-3.52	-3.66	-0.58		
802.11ac(HT20)	36	-1.18	-0.1	2.40		
	44	-1.08	-0.87	2.04		
	48	-0.05	0.19	3.08		
802.11ac(HT40)	38	-4.72	-4.69	-1.69		
	46	-4	-3.78	-0.88		
802.11ac (HT80)	42	-5.5	-6.19	-2.82		

## U-NII 3

Type	Channel	Power Spectral Density (dBm/500KHz) ANT1	Power Spectral Density (dBm/500KHz) ANT2	Power Spectral Density (dBm/500KHz) MIMO	Limit (dBm)	Result
802.11n(HT20)	149	1.15	1.38	4.28	30.0	Pass
	157	1.32	2.61	5.02		
	165	0.73	1.96	4.40		
802.11n(HT40)	151	-2.29	-2.69	0.52		
	159	-2.03	-1.79	1.10		
802.11ac(HT20)	149	0.58	1.35	3.99		
	157	1.49	2.74	5.17		
	165	0.94	2.04	4.54		
802.11ac(HT40)	151	-1.85	-2.16	1.01		
	159	-1.71	-1.47	1.42		
802.11ac (HT80)	155	-3.30	-2.53	0.11		

Test plot as follows  
ANT 1



802.11n(HT20)

U-NII 1



U-NII 3

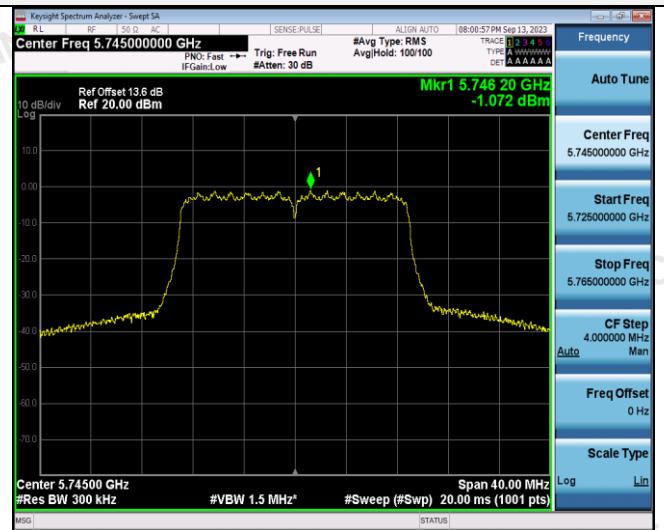

CH36



CH149



CH40

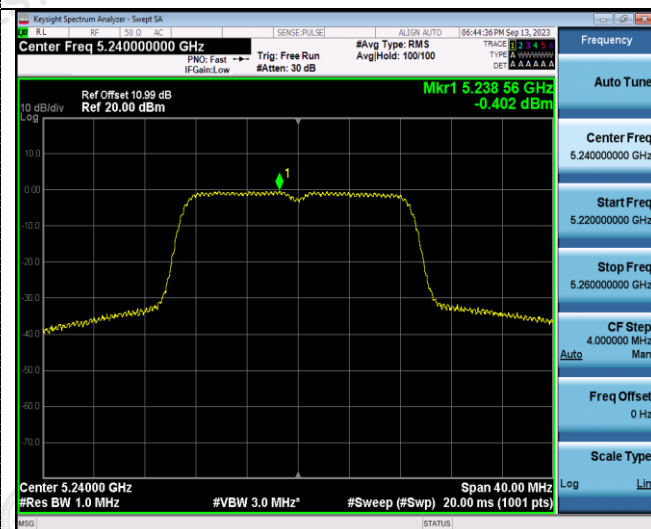

CH157

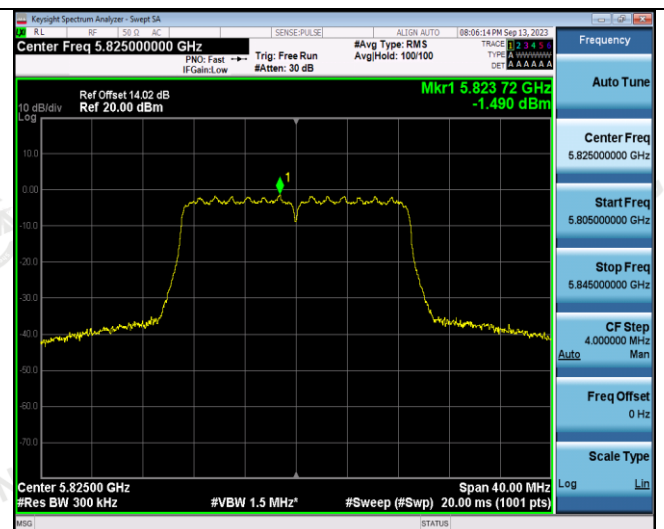

CH48

CH165

802.11n(HT40)

U-NII 1



U-NII 3

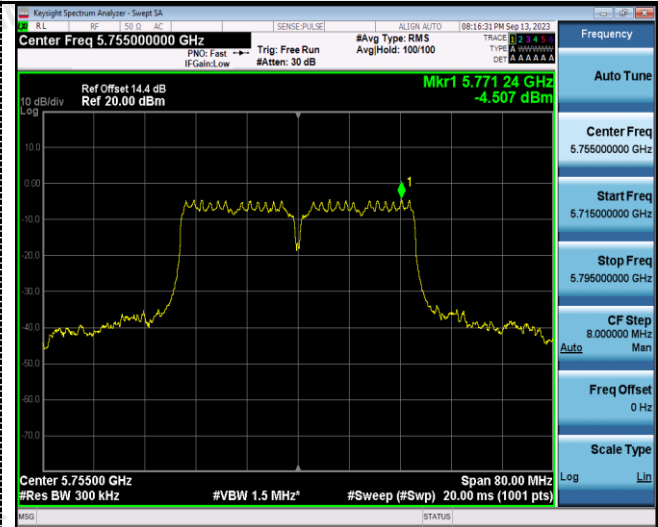

CH38

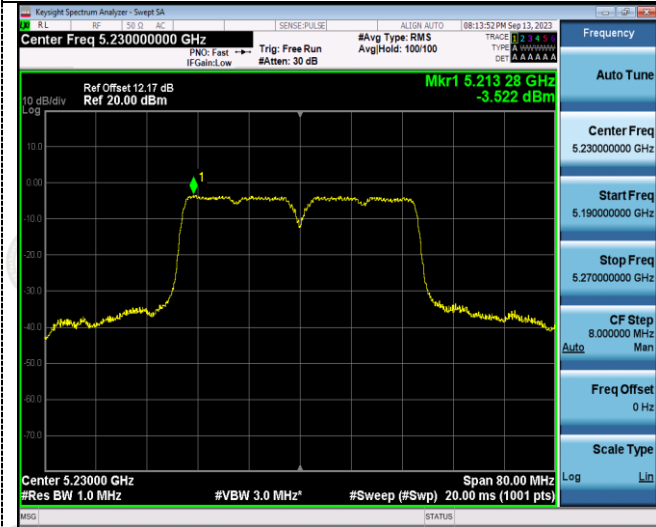

CH151

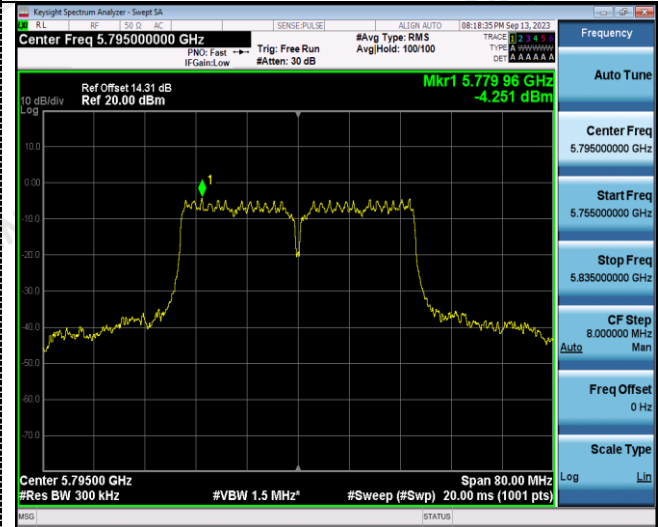

CH46



CH159



802.11ac(HT20)

U-NII 1

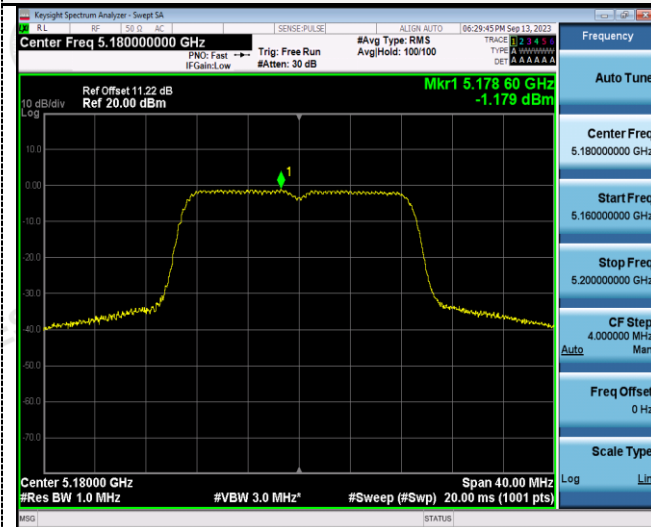

U-NII 3

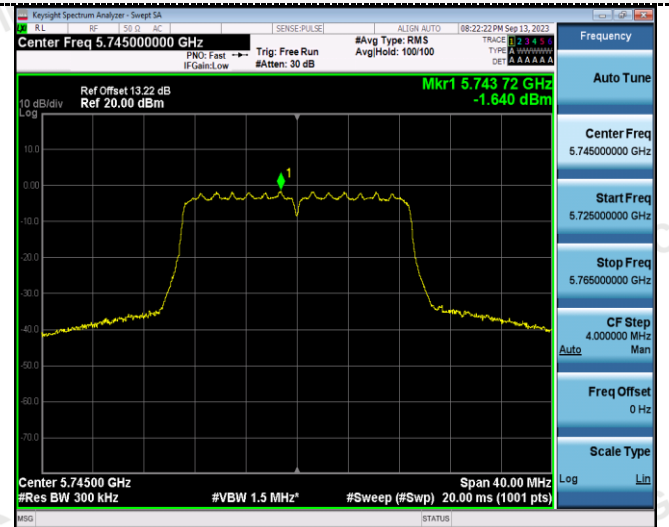

CH36

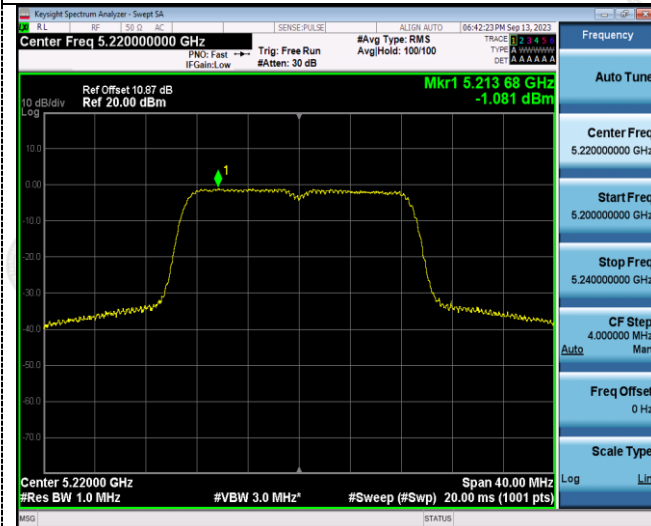

CH149



CH40



CH157

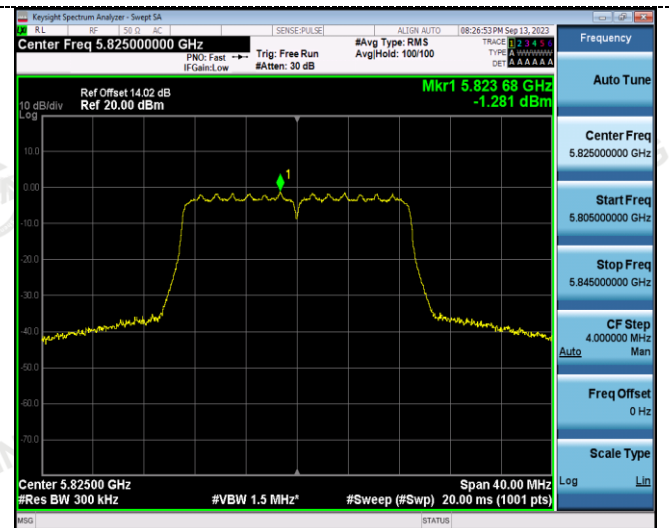

CH48

CH165



802.11ac(HT40)

U-NII 1



U-NII 3

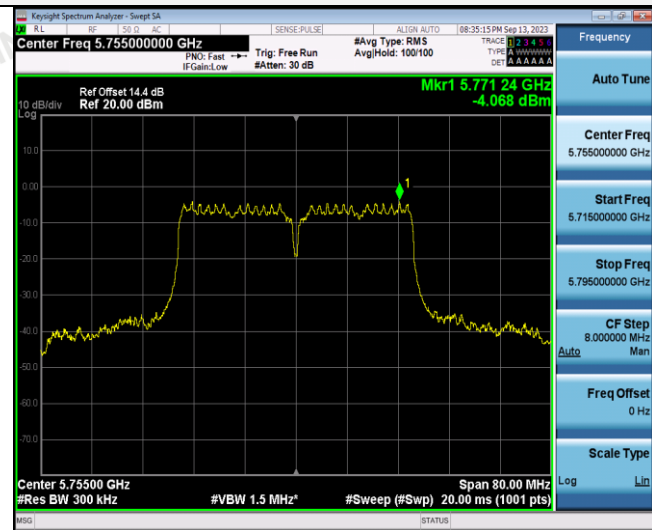

CH38



CH151

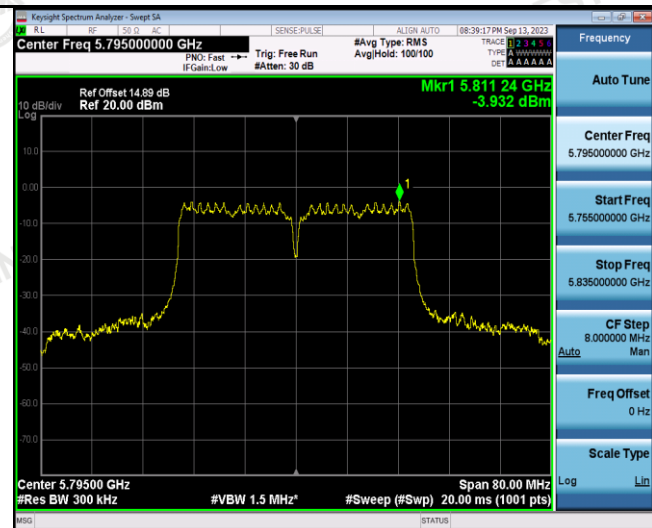

CH46

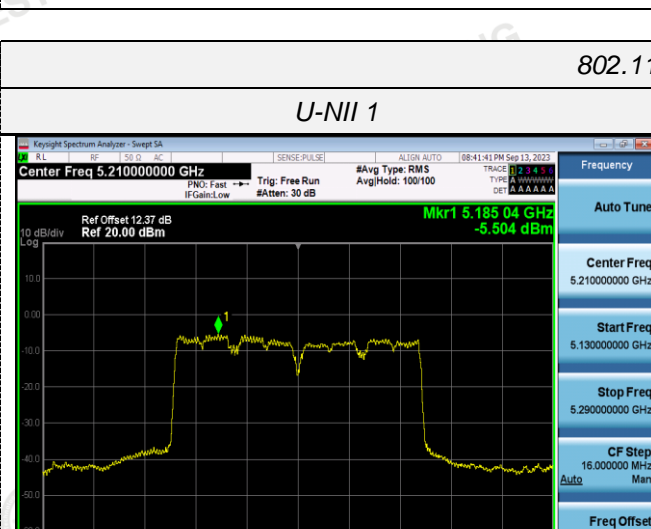

CH159

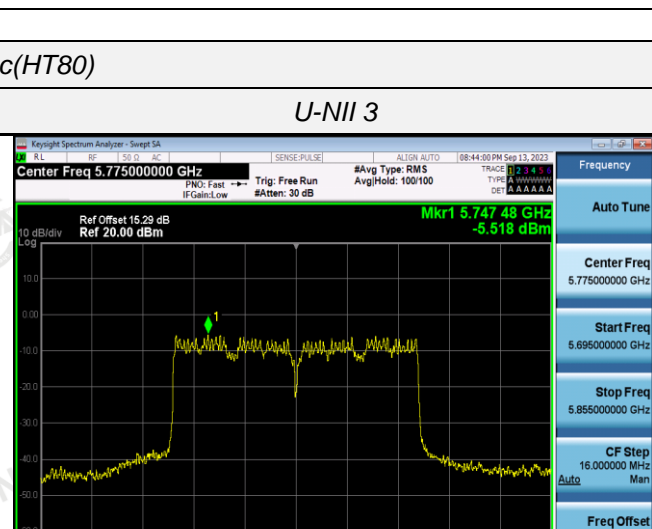

802.11ac(HT80)

U-NII 1



U-NII 3



CH42

CH155

ANT 2

802.11a

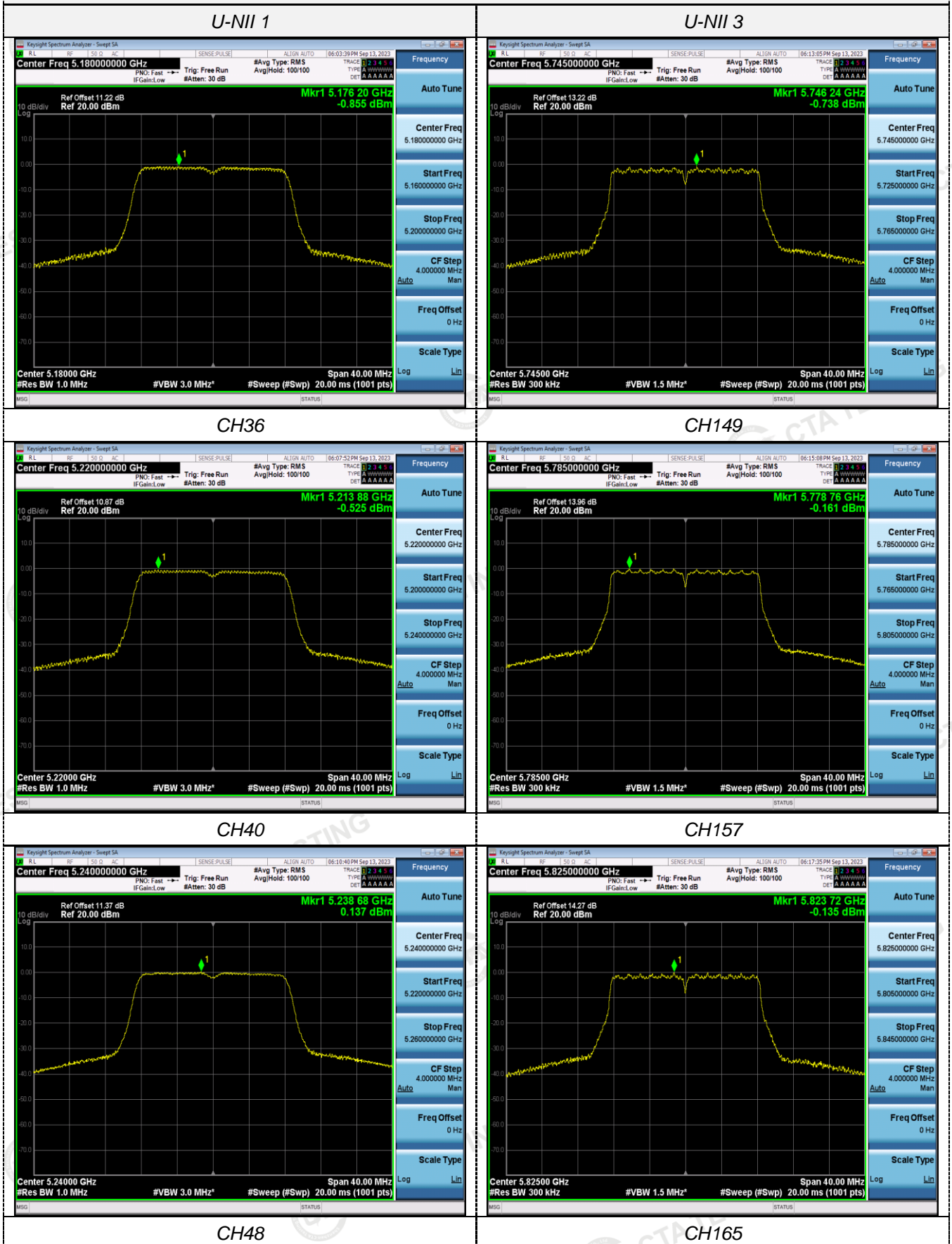

802.11n(HT20)

U-NII 1

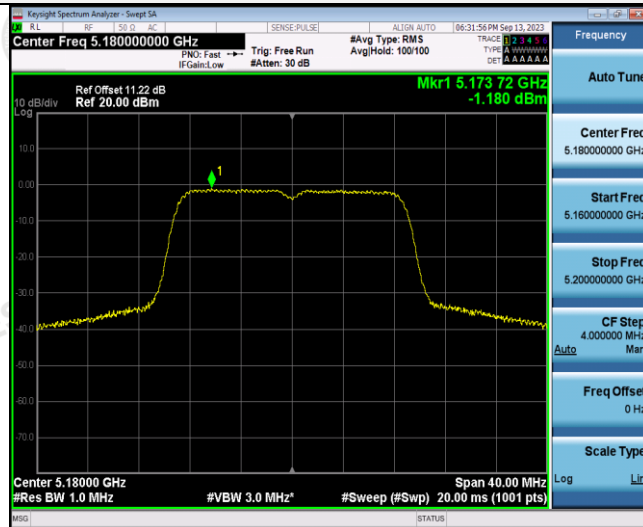

U-NII 3



CH36



CH149



CH40

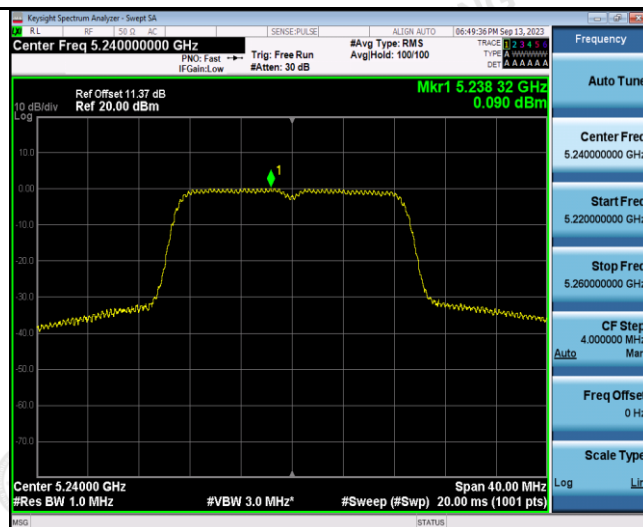

CH157

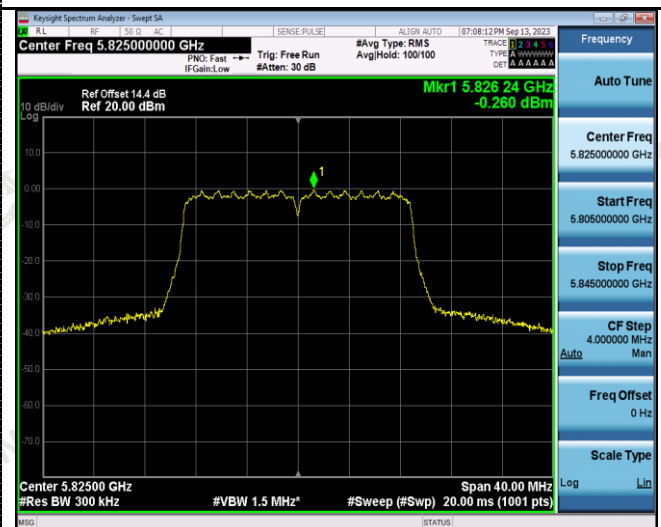

CH48

CH165