

TEST REPORT

Application No.: SZEM1906014912CR
Applicant: XIAMEN CAME TECHNOLOGY CO., LTD.
Address of Applicant: Unit 2204-1, NO.5 Chengyi North Street, Phase three Software Park, 361022, Xiamen City, Fujian Province, China
Manufacturer: XIAMEN CAME TECHNOLOGY CO., LTD.
Address of Manufacturer: Unit 2204-1, NO.5 Chengyi North Street, Phase three Software Park, 361022, Xiamen City, Fujian Province, China
Factory: XIAMEN CAME TECHNOLOGY CO., LTD.
Address of Factory: Unit 2204-1, NO.5 Chengyi North Street, Phase three Software Park, 361022, Xiamen City, Fujian Province, China

Equipment Under Test (EUT):

EUT Name: CAME-TV WIRELESS HEADSET
Model No.: WAERO-M
Trade mark: CAME-TV
FCC ID: 2ATOR-WAERO-M
Standards: 47 CFR Part 15, Subpart D
Date of Receipt: 2019-06-06
Date of Test: 2019-06-10 to 2019-06-20
Date of Issue: 2019-07-02

Test Result:	Pass*
---------------------	--------------

* In the configuration tested, the EUT complied with the standards specified above.

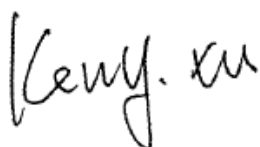



Keny Xu
 EMC Laboratory Manager



Unless otherwise agreed in writing, this document is issued by the Company subject to its General Conditions of Service printed overleaf, available on request or accessible at <http://www.sgs.com/en/Terms-and-Conditions.aspx> and, for electronic format documents, subject to Terms and Conditions for Electronic Documents at <http://www.sgs.com/en/Terms-and-Conditions/Terms-e-Documents.aspx>. Attention is drawn to the limitation of liability, indemnification and jurisdiction issues defined therein. Any holder of this document is advised that information contained hereon reflects the Company's findings at the time of its intervention only and within the limits of Client's instructions, if any. The Company's sole responsibility is to its Client and this document does not exonerate parties to a transaction from exercising all their rights and obligations under the transaction documents. This document cannot be reproduced except in full, without prior written approval of the Company. Any unauthorized alteration, forgery or falsification of the content or appearance of this document is unlawful and offenders may be prosecuted to the fullest extent of the law. Unless otherwise stated the results shown in this test report refer only to the sample(s) tested and such sample(s) are retained for 30 days only.
 Attention: To check the authenticity of testing / inspection report & certificate, please contact us at telephone: (86-755) 8307 1443, or email: CN.Doccheck@sgs.com

Revision Record				
Version	Chapter	Date	Modifier	Remark
01		2019-07-02		Original

Authorized for issue by:			
			
		<hr/> Vincent Chen /Project Engineer	
			
		<hr/> Eric Fu /Reviewer	



2 Test Summary

Test Item	FCC Test Requirement	Result
Antenna Requirement	15.317;15.203	Pass
Power Line Conducted Emission	15.207(a)	NA
Digital Modulation Techniques	15.319(b)	Pass
Channel Frequencies	15.303	Pass
Automatic discontinuation of transmission	15.319(f)	Pass
Emission Bandwidth	15.323(a)	Pass
In-band emissions	15.323(d)	Pass
Out-of-band emissions	15.323(d)	Pass
Peak Transmit Power and Antenna Gain	15.319(c)(e); 15.31(e)	Pass
Power Spectral Density	15.319(d)	Pass
Carrier frequency stability	15.323(f)	Pass
Frame repetition stability	15.323(e)	Pass
Frame period and jitter	15.323(e)	Pass
Monitoring threshold, Least interfered channel	15.323(c)(2)(5)(9)	Pass
Monitoring of intended transmit window and maximum reaction time	15.323(c)(1)	Pass
Threshold monitoring bandwidth	15.323(c)(7)	Pass
Reaction time and monitoring interval	15.323(c)(1)(5)(7)	Pass
Access criteria test interval	15.323(c)(4)(6)	Pass
Access Criteria functional test	15.323(c)(4)(6)	Pass
Acknowledgements	15.323(c)(4)	Pass
Transmission duration	15.323(c)(3)	Pass
Dual access criteria	15.323(c)(10)	Pass
Alterative monitoring interval	15.323(c)(11)(12)	N/A ¹
Spurious Emissions (Radiated)	15.319(g); 15.209(a)	Pass

¹ The client declares that the tested equipment does not implement this provision



3 Contents

	Page
1 COVER PAGE	1
2 TEST SUMMARY	3
3 CONTENTS	4
4 GENERAL INFORMATION	5
4.1 DETAILS OF E.U.T.	5
4.2 TEST ENVIRONMENT AND MODE.....	5
4.3 DESCRIPTION OF SUPPORT UNITS.....	6
4.4 MEASUREMENT UNCERTAINTY	6
4.5 TEST LOCATION	7
4.6 TEST FACILITY	7
4.7 DEVIATION FROM STANDARDS	7
4.8 ABNORMALITIES FROM STANDARD CONDITIONS	7
5 EQUIPMENT LIST	8
6 TEST RESULTS AND MEASUREMENT DATA	10
6.1 ANTENNA REQUIREMENT	10
6.2 DIGITAL MODULATION TECHNIQUES.....	10
6.3 AUTOMATIC DISCONTINUATION OF TRANSMISSION	11
6.4 PEAK POWER OUTPUT	12
6.5 EMISSION BANDWIDTH B	15
6.6 POWER SPECTRAL DENSITY	18
6.7 IN-BAND UNWANTED EMISSIONS, CONDUCTED	21
6.8 OUT-OF-BAND EMISSIONS, CONDUCTED	24
6.9 CARRIER FREQUENCY STABILITY	28
6.10 FRAME REPETITION STABILITY	29
6.11 FRAME PERIOD AND JITTER	30
6.12 MONITORING THRESHOLD, LEAST INTERFERED CHANNEL	31
6.13 THRESHOLD MONITORING BANDWIDTH	33
6.14 REACTION TIME AND MONITORING INTERVAL	34
6.15 TIME AND SPECTRUM WINDOW ACCESS PROCEDURE	35
6.16 ACKNOWLEDGEMENTS AND TRANSMISSION DURATION	37
6.17 DUAL ACCESS CRITERIA CHECK	39
6.18 RADIATED SPURIOUS EMISSIONS	40
7 PHOTOGRAPHS	44
7.1 EUT CONSTRUCTIONAL DETAILS (EUT PHOTOS)	44



Unless otherwise agreed in writing, this document is issued by the Company subject to its General Conditions of Service printed overleaf, available on request or accessible at <http://www.sgs.com/en/Terms-and-Conditions.aspx> and, for electronic format documents, subject to Terms and Conditions for Electronic Documents at <http://www.sgs.com/en/Terms-and-Conditions/Terms-e-Documents.aspx>. Attention is drawn to the limitation of liability, indemnification and jurisdiction issues defined therein. Any holder of this document is advised that information contained hereon reflects the Company's findings at the time of its intervention only and within the limits of Client's instructions, if any. The Company's sole responsibility is to its Client and this document does not exonerate parties to a transaction from exercising all their rights and obligations under the transaction documents. This document cannot be reproduced except in full, without prior written approval of the Company. Any unauthorized alteration, forgery or falsification of the content or appearance of this document is unlawful and offenders may be prosecuted to the fullest extent of the law. Unless otherwise stated the results shown in this test report refer only to the sample(s) tested and such sample(s) are retained for 30 days only.

Attention: To check the authenticity of testing /inspection report & certificate, please contact us at telephone: (86-755) 8307 1443, or email: CN.Doccheck@sgs.com

4 General Information

4.1 Details of E.U.T.

Power supply:	DC 3.7V 1600mAh from Li-ion battery pack(Model:NB-6L) Charged by DC 5V from USB port
Cable:	USB cable 91cm unshielded
Frequency Range:	1921.536 to 1928.448 MHz
Number of Channels:	5 RF Channels, 5 × 12 = 60 TDMA Duplex Channels
Type of Modulation:	Digital (Gaussian Frequency Shift Keying)
Modulation Technique:	GFSK
Antenna Connector:	None (Monopole Antenna)
Antenna Gain:	0dBi
Number of Antennas:	1
Antenna Diversity Supported:	No
Hardware Version:	V1.0
Software Version:	V1.0

Note:

In section 15.31(m), regards to the operating frequency range over 10 MHz, the Lowest frequency, the middle frequency, and the highest frequency of channel were selected to perform the test, and the selected channel see below:

Channel	Frequency
The Lowest channel(CH4)	1921.536 MHz
The Middle channel(CH2)	1924.992 MHz
The Highest channel(CH0)	1928.448 MHz

4.2 Test Environment and Mode

Operating Environment:	
Temperature:	25.6 °C
Humidity:	54 % RH
Atmospheric Pressure:	1005 mbar
Test mode:	
Transmitting mode:	Keep the EUT in transmitting mode with modulation.



Unless otherwise agreed in writing, this document is issued by the Company subject to its General Conditions of Service printed overleaf, available on request or accessible at <http://www.sgs.com/en/Terms-and-Conditions.aspx> and, for electronic format documents, subject to Terms and Conditions for Electronic Documents at <http://www.sgs.com/en/Terms-and-Conditions/Terms-e-Documents.aspx>. Attention is drawn to the limitation of liability, indemnification and jurisdiction issues defined therein. Any holder of this document is advised that information contained hereon reflects the Company's findings at the time of its intervention only and within the limits of Client's instructions, if any. The Company's sole responsibility is to its Client and this document does not exonerate parties to a transaction from exercising all their rights and obligations under the transaction documents. This document cannot be reproduced except in full, without prior written approval of the Company. Any unauthorized alteration, forgery or falsification of the content or appearance of this document is unlawful and offenders may be prosecuted to the fullest extent of the law. Unless otherwise stated the results shown in this test report refer only to the sample(s) tested and such sample(s) are retained for 30 days only.
 Attention: To check the authenticity of testing /inspection report & certificate, please contact us at telephone: (86-755) 8307 1443, or email: CN.Doccheck@sgs.com

4.3 Description of Support Units

The EUT has been tested with associated equipment below:

Description	Manufacturer	Model No.
CAME-TV WIRELESS HEADSET	CAME-TV	WAERO-R

4.4 Measurement Uncertainty

No.	Item	Measurement Uncertainty
1	Radio Frequency	$\pm 7.25 \times 10^{-8}$
2	Duty cycle	$\pm 0.37\%$
3	Occupied Bandwidth	$\pm 3\%$
4	RF conducted power	$\pm 0.75\text{dB}$
5	RF power density	$\pm 2.84\text{dB}$
6	Conducted Spurious emissions	$\pm 0.75\text{dB}$
7	RF Radiated power	$\pm 4.5\text{dB}$ (Below 1GHz)
		$\pm 4.8\text{dB}$ (Above 1GHz)
8	Radiated Spurious emission test	$\pm 4.5\text{dB}$ (Below 1GHz)
		$\pm 4.8\text{dB}$ (Above 1GHz)
9	Temperature test	$\pm 1^\circ\text{C}$
10	Humidity test	$\pm 3\%$
11	Supply voltages	$\pm 1.5\%$
12	Time	$\pm 3\%$



Unless otherwise agreed in writing, this document is issued by the Company subject to its General Conditions of Service printed overleaf, available on request or accessible at <http://www.sgs.com/en/Terms-and-Conditions.aspx> and, for electronic format documents, subject to Terms and Conditions for Electronic Documents at <http://www.sgs.com/en/Terms-and-Conditions/Terms-e-Documents.aspx>. Attention is drawn to the limitation of liability, indemnification and jurisdiction issues defined therein. Any holder of this document is advised that information contained hereon reflects the Company's findings at the time of its intervention only and within the limits of Client's instructions, if any. The Company's sole responsibility is to its Client and this document does not exonerate parties to a transaction from exercising all their rights and obligations under the transaction documents. This document cannot be reproduced except in full, without prior written approval of the Company. Any unauthorized alteration, forgery or falsification of the content or appearance of this document is unlawful and offenders may be prosecuted to the fullest extent of the law. Unless otherwise stated the results shown in this test report refer only to the sample(s) tested and such sample(s) are retained for 30 days only.
 Attention: To check the authenticity of testing /inspection report & certificate, please contact us at telephone: (86-755) 8307 1443, or email: CN.Doccheck@sgs.com

4.5 Test Location

All tests were performed at:

SGS-CSTC Standards Technical Services Co., Ltd., Shenzhen Branch

No. 1 Workshop, M-10, Middle Section, Science & Technology Park, Shenzhen, Guangdong, China. 518057.

Tel: +86 755 2601 2053 Fax: +86 755 2671 0594

No tests were sub-contracted.

4.6 Test Facility

The test facility is recognized, certified, or accredited by the following organizations:

- **CNAS (No. CNAS L2929)**

CNAS has accredited SGS-CSTC Standards Technical Services Co., Ltd. Shenzhen Branch EMC Lab to ISO/IEC 17025:2005 General Requirements for the Competence of Testing and Calibration Laboratories (CNAS-CL01 Accreditation Criteria for the Competence of Testing and Calibration Laboratories) for the competence in the field of testing.

- **A2LA (Certificate No. 3816.01)**

SGS-CSTC Standards Technical Services Co., Ltd., Shenzhen EMC Laboratory is accredited by the American Association for Laboratory Accreditation(A2LA). Certificate No. 3816.01.

- **VCCI**

The 3m Fully-anechoic chamber for above 1GHz, 10m Semi-anechoic chamber for below 1GHz, Shielded Room for Mains Port Conducted Interference Measurement and Telecommunication Port Conducted Interference Measurement of SGS-CSTC Standards Technical Services Co., Ltd. have been registered in accordance with the Regulations for Voluntary Control Measures with Registration No.: G-20026, R-14188, C-12383 and T-11153 respectively.

- **FCC –Designation Number: CN1178**

SGS-CSTC Standards Technical Services Co., Ltd., Shenzhen EMC Laboratory has been recognized as an accredited testing laboratory.

Designation Number: CN1178. Test Firm Registration Number: 406779.

- **Innovation, Science and Economic Development Canada**

SGS-CSTC Standards Technical Services Co., Ltd., Shenzhen EMC Laboratory has been recognized by ISED as an accredited testing laboratory.

CAB identifier: CN0006.

IC#: 4620C.

4.7 Deviation from Standards

None

4.8 Abnormalities from Standard Conditions

None



5 Equipment List

Radiated Emissions (30MHz-1GHz)					
Equipment	Manufacturer	Model No	Inventory No	Cal Date	Cal Due Date
3m Semi-Anechoic Chamber	ETS-LINDGREN	N/A	SEM001-01	2017-08-05	2020-08-04
Measurement Software	AUDIX	e3 V8.2014-6-27	N/A	N/A	N/A
Coaxial Cable	SGS	N/A	SEM025-01	2018-07-12	2019-07-11
EMI Test Receiver	Agilent Technologies	N9038A	SEM004-05	2018-09-25	2019-09-24
BiConiLog Antenna (26-3000MHz)	ETS-LINDGREN	3142C	SEM003-01	2017-06-27	2020-06-26
Pre-amplifier (0.1-1300MHz)	Agilent Technologies	8447D	SEM005-01	2019-04-01	2020-03-31
Digital Radiocommunication Tester	Rohde & Schwarz	CMD60	/	2018-12-18	2019-12-18

Radiated Spurious Emission					
Equipment	Manufacturer	Model No	Inventory No	Cal Date	Cal Due Date
3m Semi-Anechoic Chamber	AUDIX	N/A	SEM001-02	2018-03-13	2021-03-12
Measurement Software	AUDIX	e3 V8.2014-6-27	N/A	N/A	N/A
Coaxial Cable	SGS	N/A	SEM026-01	2018-07-12	2019-07-11
EXA Spectrum Analyzer	Agilent Technologies Inc	N9010A	SEM004-12	2019-04-12	2020-04-11
Horn Antenna (1-18GHz)	Rohde & Schwarz	HF907	SEM003-07	2018-04-13	2021-04-12
Horn Antenna (15GHz-40GHz)	Schwarzbeck	BBHA 9170	SEM003-15	2017-10-17	2020-10-16
Pre-Amplifier (0.1-26.5GHz)	Compliance Directions Systems Inc.	PAP-0126	SEM004-11	2018-11-12	2019-11-11
Pre-amplifier (18-26GHz)	Rohde & Schwarz	CH14-H052	SEM005-17	2019-04-01	2020-03-31
Pre-amplifier (26GHz-40GHz)	Compliance Directions Systems Inc.	PAP-2640-50	SEM005-08	2019-04-01	2020-03-31
Digital Radio communication Tester	Rohde & Schwarz	CMD60	/	2018-12-18	2019-12-18
DC Power Supply	Zhao Xin	RXN-305D	SEM011-02	2018-09-25	2019-09-24
Active Loop Antenna	ETS-Lindgren	6502	SEM003-08	2017-08-22	2020-08-21



Unless otherwise agreed in writing, this document is issued by the Company subject to its General Conditions of Service printed overleaf, available on request or accessible at <http://www.sgs.com/en/Terms-and-Conditions.aspx> and, for electronic format documents, subject to Terms and Conditions for Electronic Documents at <http://www.sgs.com/en/Terms-and-Conditions/Terms-e-Documents.aspx>. Attention is drawn to the limitation of liability, indemnification and jurisdiction issues defined therein. Any holder of this document is advised that information contained hereon reflects the Company's findings at the time of its intervention only and within the limits of Client's instructions, if any. The Company's sole responsibility is to its Client and this document does not exonerate parties to a transaction from exercising all their rights and obligations under the transaction documents. This document cannot be reproduced except in full, without prior written approval of the Company. Any unauthorized alteration, forgery or falsification of the content or appearance of this document is unlawful and offenders may be prosecuted to the fullest extent of the law. Unless otherwise stated the results shown in this test report refer only to the sample(s) tested and such sample(s) are retained for 30 days only.

RF conducted test					
Test Equipment	Manufacturer	Model No.	Inventory No.	Cal. date	Cal. Due date
DC Power Supply	ZhaoXin	RXN-305D	SEM011-02	2018-09-25	2019-09-24
EXA Spectrum Analyzer	KEYSIGHT	N9010A	SEM004-12	2019-04-12	2020-04-11
Signal Generator	Rohde & Schwarz	SML03	SEM006-02	2019-04-25	2020-04-25
Power Meter	Rohde & Schwarz	NRVS	SEM014-02	2018-09-25	2019-09-24
Spectrum Analyzer	Rohde & Schwarz	FSU43	SEM004-08	2019-04-02	2020-04-01
Coaxial Cable	SGS	N/A	SEM031-01	2018-07-12	2019-07-11
Digital Radiocommunication Tester	Rohde & Schwarz	CMD60	/	2018-12-18	2019-12-18
Splitter	MACOM	2090-6214-00	SEL0226	2018-03-06	2019-03-06

General used equipment					
Equipment	Manufacturer	Model No	Inventory No	Cal Date	Cal Due Date
Humidity/ Temperature Indicator	Shanghai Meteorological Industry Factory	ZJ1-2B	SEM002-03	2018-09-27	2019-09-26
Humidity/ Temperature Indicator	Shanghai Meteorological Industry Factory	ZJ1-2B	SEM002-04	2018-09-27	2019-09-26
Humidity/ Temperature Indicator	Mingle	N/A	SEM002-08	2018-09-27	2019-09-26
Barometer	Changchun Meteorological Industry Factory	DYM3	SEM002-01	2019-04-04	2020-04-03



Unless otherwise agreed in writing, this document is issued by the Company subject to its General Conditions of Service printed overleaf, available on request or accessible at <http://www.sgs.com/en/Terms-and-Conditions.aspx> and, for electronic format documents, subject to Terms and Conditions for Electronic Documents at <http://www.sgs.com/en/Terms-and-Conditions/Terms-e-Documents.aspx>. Attention is drawn to the limitation of liability, indemnification and jurisdiction issues defined therein. Any holder of this document is advised that information contained hereon reflects the Company's findings at the time of its intervention only and within the limits of Client's instructions, if any. The Company's sole responsibility is to its Client and this document does not exonerate parties to a transaction from exercising all their rights and obligations under the transaction documents. This document cannot be reproduced except in full, without prior written approval of the Company. Any unauthorized alteration, forgery or falsification of the content or appearance of this document is unlawful and offenders may be prosecuted to the fullest extent of the law. Unless otherwise stated the results shown in this test report refer only to the sample(s) tested and such sample(s) are retained for 30 days only.
 Attention: To check the authenticity of testing /inspection report & certificate, please contact us at telephone: (86-755) 8307 1443, or email: CN.Doccheck@sgs.com

6 Test results and Measurement Data

6.1 Antenna Requirement

Standard requirement:	47 CFR Part 15.317, 15.203
15.203 requirement: An intentional radiator shall be designed to ensure that no antenna other than that furnished by the responsible party shall be used with the device. The use of a permanently attached antenna or of an antenna that uses a unique coupling to the intentional radiator, the manufacturer may design the unit so that a broken antenna can be replaced by the user, but the use of a standard antenna jack or electrical connector is prohibited.	
EUT Antenna:	
The antenna is integrated on the main PCB and no consideration of replacement. The best case gain of the antenna is 0dBi.	

6.2 Digital Modulation Techniques

Standard requirement:	47 CFR Part 15.319(b)
Requirement: All transmissions must use only digital modulation techniques.	
The EUT uses Multi Carrier / Time Division Multiple Access / Time Division Duplex and Digital GFSK modulation. For further details see the operational description provided by the applicant.	

6.3 Automatic discontinuation of transmission

Test Requirement:	47 CFR Part 15.319(f)
Test Method:	Declared by manufacture
Requirement:	The device shall automatically discontinue transmission in case of either absence of information to transmit or operational failure. These provisions are not intended to preclude transmission of control and signaling information or use of repetitive codes used by certain digital technologies to complete frame or burst intervals.
Test Results:	Pass

The following tests simulate the reaction of the EUT in case of either absence of information to transmit or operational failure after a connection with the companion device is established.

Number	Test	EUT Reaction	Verdict
1	Power removed from EUT	C	Pass
2	Switch Off EUT	N/A	Pass
3	Hook-On by EUT	N/A	Pass
4	Power Removed from Companion Device	A	Pass
5	Switch Off Companion Device	N/A	Pass
6	Hook-On by Companion Device	N/A	Pass

A - Connection breakdown, Cease of all transmissions

B - Connection breakdown, EUT transmits control and signaling information

C - Connection breakdown, Companion Device transmits control and signaling information

N/A - Not Applicable (EUT/Companion Device does not have On/Off switch and cannot perform Hook-On)

Note: For more information please refer to declaration letter.

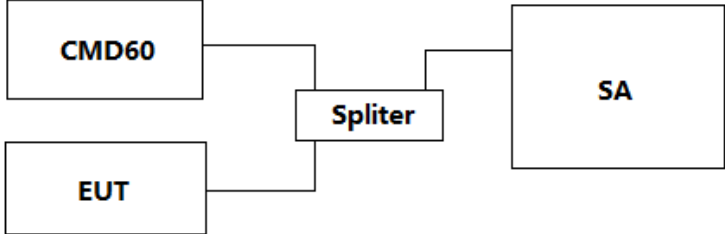

6.4 Peak Power Output

Test Requirement:	47 CFR Part 15.319(c)(e), 15.31(e)
Test Method:	ANSI C63.17: 2013
Limit:	Peak transmit power shall not exceed 100 microwatts multiplied by the square root of the emission bandwidth in Hertz. The peak transmit power shall be reduced by the amount in decibels that the maximum directional gain of the antenna exceeds 3dBi.
Test Procedure:	RBW: \geq Emission bandwidth Video bandwidth: \geq RBW Span: Zero Center frequency: Nominal center frequency of transmit carrier Amplitude scale: Log (linear may be used if analyzer has sufficient linear dynamic range and accuracy) Detection: Peak detection Trigger: Video Sweep rate: Sufficiently rapid to permit the transmit pulse to be resolved accurately
Test Setup:	 <pre> graph LR CMD60[CMD60] --- Splitter[Splitter] EUT[EUT] --- Splitter Splitter --- SA[SA] </pre>
Test Mode:	Transmitting mode
Instruments Used:	Refer to section 5.0 for details

Channel	Frequency (MHz)	Measured Peak Transmit Power (dBm)	Limit (dBm)	Results
Lowest	1921.536	19.70	20.85	Pass
Middle	1924.992	19.88	20.85	Pass
Highest	1928.448	20.04	20.78	Pass

The plots of peak transmit power are saved as below.



Plots of peak transmit power:

Lowest channel, Traffic carrier

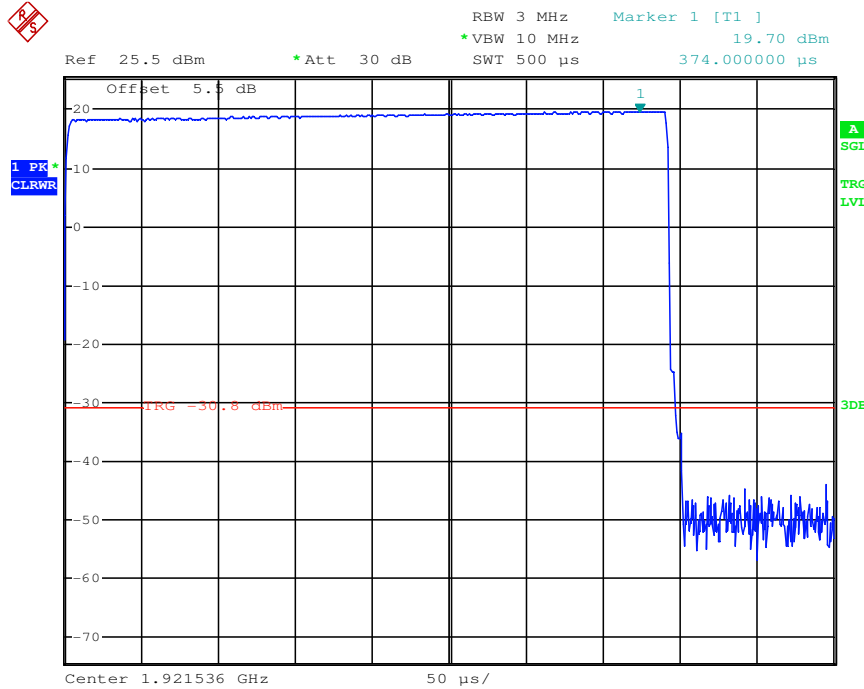

Middle channel, Traffic carrier

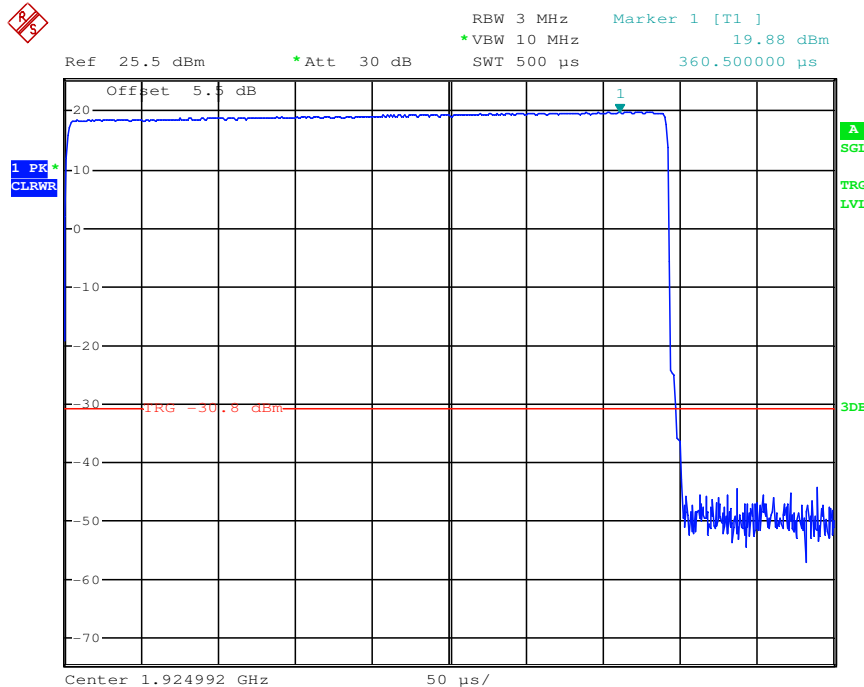

Unless otherwise agreed in writing, this document is issued by the Company subject to its General Conditions of Service printed overleaf, available on request or accessible at <http://www.sgs.com/en/Terms-and-Conditions.aspx> and, for electronic format documents, subject to Terms and Conditions for Electronic Documents at <http://www.sgs.com/en/Terms-and-Conditions/Terms-e-Documents.aspx>. Attention is drawn to the limitation of liability, indemnification and jurisdiction issues defined therein. Any holder of this document is advised that information contained hereon reflects the Company's findings at the time of its intervention only and within the limits of Client's instructions, if any. The Company's sole responsibility is to its Client and this document does not exonerate parties to a transaction from exercising all their rights and obligations under the transaction documents. This document cannot be reproduced except in full, without prior written approval of the Company. Any unauthorized alteration, forgery or falsification of the content or appearance of this document is unlawful and offenders may be prosecuted to the fullest extent of the law. Unless otherwise stated the results shown in this test report refer only to the sample(s) tested and such sample(s) are retained for 30 days only.
 Attention: To check the authenticity of testing /inspection report & certificate, please contact us at telephone: (86-755) 8307 1443, or email: CN.Doccheck@sgs.com

Highest channel, Traffic carrier

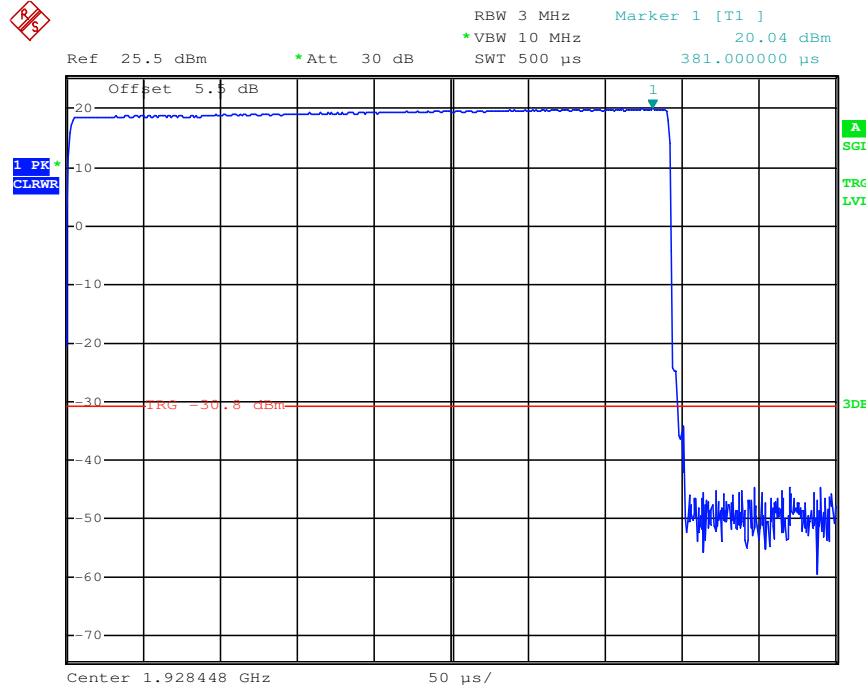

Unless otherwise agreed in writing, this document is issued by the Company subject to its General Conditions of Service printed overleaf, available on request or accessible at <http://www.sgs.com/en/Terms-and-Conditions.aspx> and, for electronic format documents, subject to Terms and Conditions for Electronic Documents at <http://www.sgs.com/en/Terms-and-Conditions/Terms-e-Documents.aspx>. Attention is drawn to the limitation of liability, indemnification and jurisdiction issues defined therein. Any holder of this document is advised that information contained hereon reflects the Company's findings at the time of its intervention only and within the limits of Client's instructions, if any. The Company's sole responsibility is to its Client and this document does not exonerate parties to a transaction from exercising all their rights and obligations under the transaction documents. This document cannot be reproduced except in full, without prior written approval of the Company. Any unauthorized alteration, forgery or falsification of the content or appearance of this document is unlawful and offenders may be prosecuted to the fullest extent of the law. Unless otherwise stated the results shown in this test report refer only to the sample(s) tested and such sample(s) are retained for 30 days only.

Attention: To check the authenticity of testing /inspection report & certificate, please contact us at telephone: (86-755) 8307 1443, or email: CN.Doccheck@sgs.com

6.5 Emission Bandwidth B

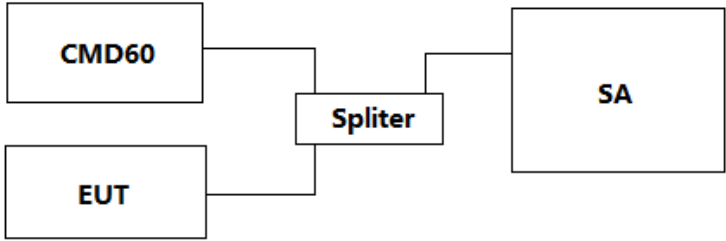
Test Requirement:	47 CFR Part 15.323(a)
Test Method:	ANSI C63.17: 2013
Limit:	The Emission Bandwidth B shall be larger than 50 kHz and less than 2.5 MHz. No requirements for 6 and 12 dB Bandwidth, these values are only used for testing Monitoring Bandwidth if the Simple Compliance test fails (ANSI C63.17, clause 7.4).
Test Procedure:	RBW: Approximately 1% of the emission bandwidth (a rough estimate may be obtained from peak power level measurement, or use manufacturer's declared value) Video bandwidth: $\geq 3 \times$ the RBW Center frequency: Nominal center frequency of channel Span: $\geq 2 \times$ the expected emission bandwidth Sweep time: Coupled to frequency span and RBW Amplitude scale: Log Detection: Peak detection with maximum hold enabled
Test Setup:	 <pre> graph LR EUT[EUT] --- Splitter[Splitter] Splitter --- CMD60[CMD60] Splitter --- SA[SA] </pre>
Test Mode:	Transmitting mode
Instruments Used:	Refer to section 5.0 for details

Channel	Frequency (MHz)	Emission Bandwidth B (MHz)
Lowest	1921.536	1.43
Middle	1924.992	1.48
Highest	1928.448	1.48



Emission Bandwidth

Lowest channel:

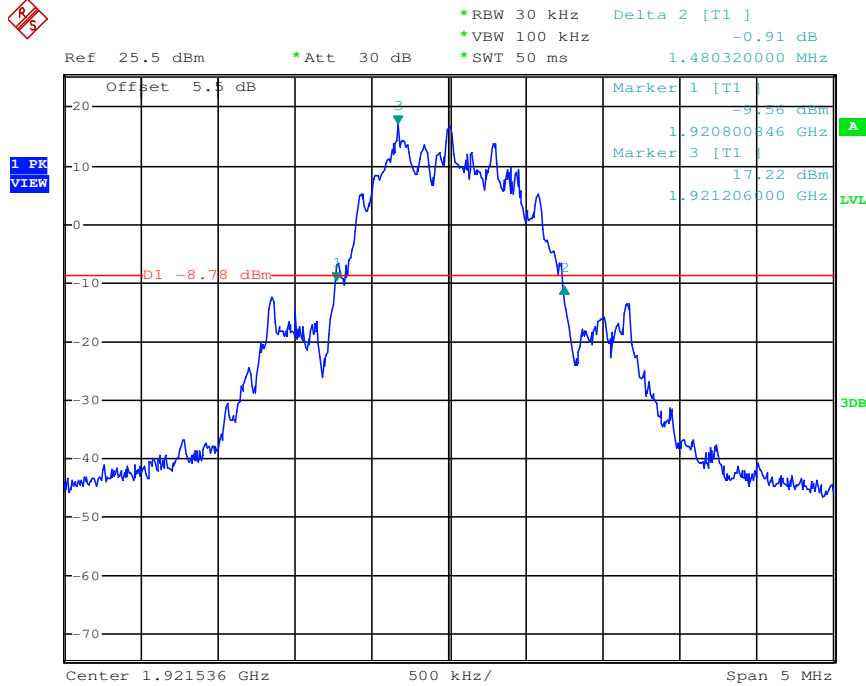

Middle channel:

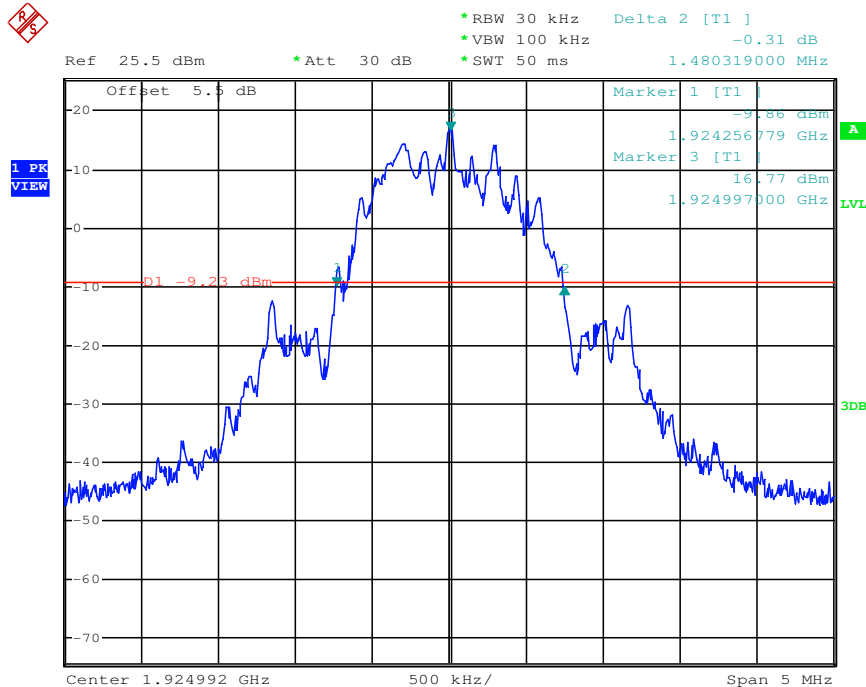

Highest channel:

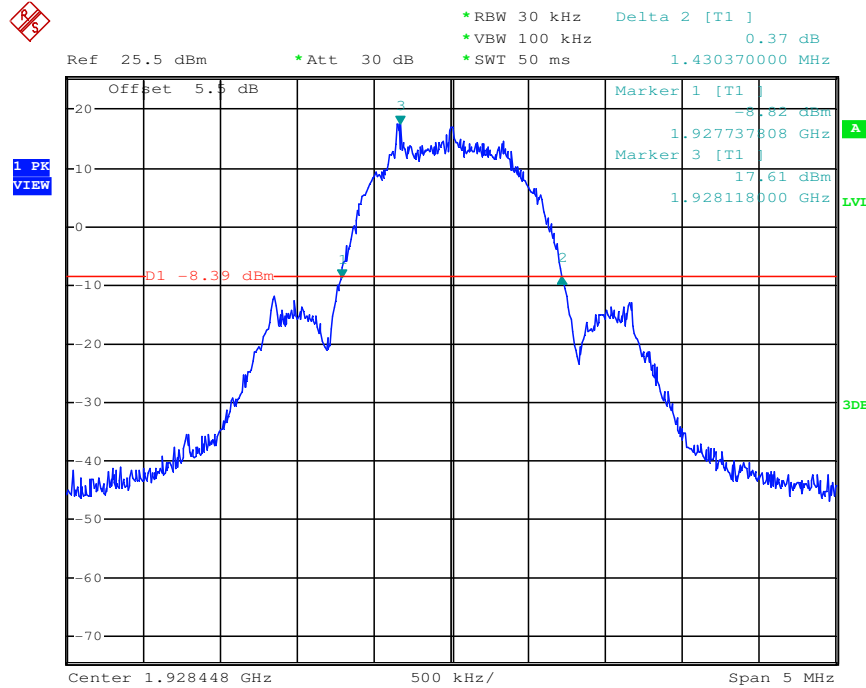

6.6 Power Spectral Density

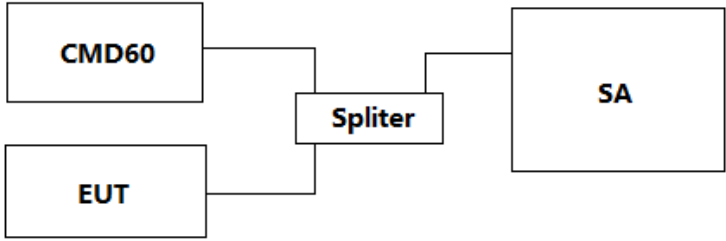
Test Requirement:	47 CFR Part 15.319(d), RSS-213 5.7
Test Method:	ANSI C63.17: 2013
Limit:	FCC: Power spectral density shall not exceed 3 milliwatts in any 3 kHz bandwidth as measured with a spectrum analyzer having a resolution bandwidth of 3 kHz
Test Procedure:	RBW: 3 kHz Video bandwidth: $\geq 3 \times \text{RBW}$ Span: Zero span at frequency with the maximum level (frequency determined in 6.1.3 if the same type of signal (continuous versus burst) was used in 6.1.3) Center frequency: Spectral peak as determined in 6.1.3 Sweep time: For burst signals, sufficient to include essentially all of the maximum length burst at the output of a 3 kHz filter (e.g., maximum input burst duration plus 600 μs). For continuous signals, 20 ms. Amplitude scale: Log power Detection: Sample detection and averaged for a minimum of 100 sweeps Trigger: External or internal
Test Setup:	 <pre> graph LR EUT[EUT] --- Splitter[Splitter] CMD60[CMD60] --- Splitter Splitter --- SA[SA] </pre>
Test Mode:	Transmitting mode
Instruments Used:	Refer to section 5.0 for details

Test Results:

Channel	Frequency (MHz)	Power Spectral Density (dBm/3 kHz)	Limit (dBm/3 kHz)	Results
Lowest	1921.536	0.07	4.8	Pass
Highest	1928.448	1.26	4.8	Pass



Unless otherwise agreed in writing, this document is issued by the Company subject to its General Conditions of Service printed overleaf, available on request or accessible at <http://www.sgs.com/en/Terms-and-Conditions.aspx> and, for electronic format documents, subject to Terms and Conditions for Electronic Documents at <http://www.sgs.com/en/Terms-and-Conditions/Terms-e-Documents.aspx>. Attention is drawn to the limitation of liability, indemnification and jurisdiction issues defined therein. Any holder of this document is advised that information contained hereon reflects the Company's findings at the time of its intervention only and within the limits of Client's instructions, if any. The Company's sole responsibility is to its Client and this document does not exonerate parties to a transaction from exercising all their rights and obligations under the transaction documents. This document cannot be reproduced except in full, without prior written approval of the Company. Any unauthorized alteration, forgery or falsification of the content or appearance of this document is unlawful and offenders may be prosecuted to the fullest extent of the law. Unless otherwise stated the results shown in this test report refer only to the sample(s) tested and such sample(s) are retained for 30 days only.
Attention: To check the authenticity of testing /inspection report & certificate, please contact us at telephone: (86-755) 8307 1443, or email: CN.Doccheck@sgs.com

Power Spectral Density:

Lowest channel:

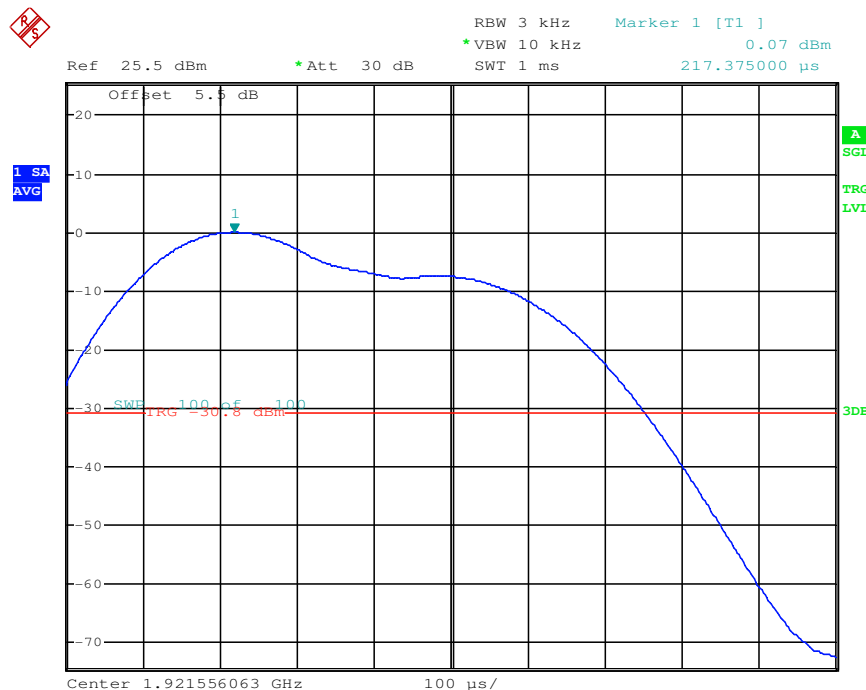
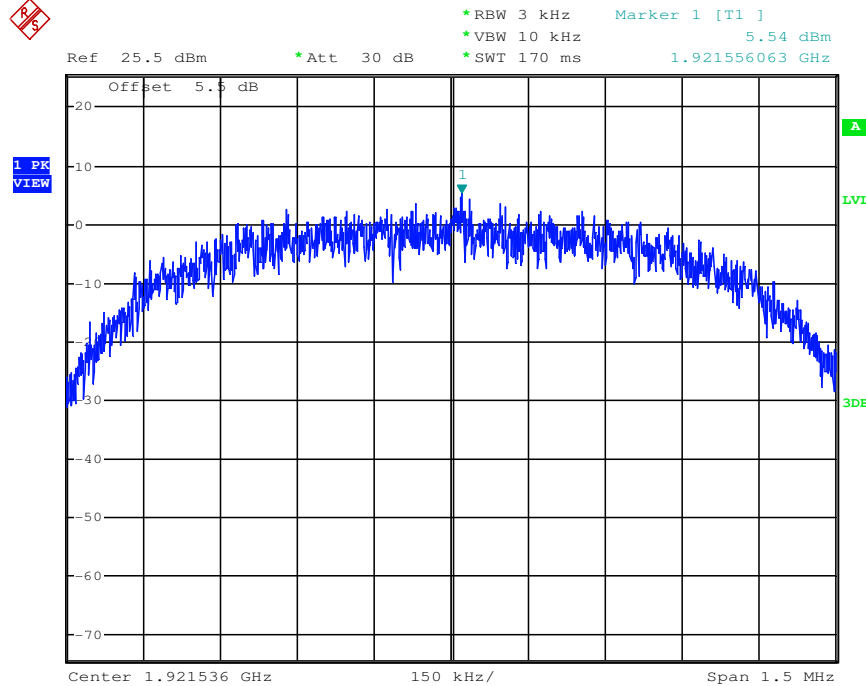

Unless otherwise agreed in writing, this document is issued by the Company subject to its General Conditions of Service printed overleaf, available on request or accessible at <http://www.sgs.com/en/Terms-and-Conditions.aspx> and, for electronic format documents, subject to Terms and Conditions for Electronic Documents at <http://www.sgs.com/en/Terms-and-Conditions/Terms-e-Documents.aspx>. Attention is drawn to the limitation of liability, indemnification and jurisdiction issues defined therein. Any holder of this document is advised that information contained hereon reflects the Company's findings at the time of its intervention only and within the limits of Client's instructions, if any. The Company's sole responsibility is to its Client and this document does not exonerate parties to a transaction from exercising all their rights and obligations under the transaction documents. This document cannot be reproduced except in full, without prior written approval of the Company. Any unauthorized alteration, forgery or falsification of the content or appearance of this document is unlawful and offenders may be prosecuted to the fullest extent of the law. Unless otherwise stated the results shown in this test report refer only to the sample(s) tested and such sample(s) are retained for 30 days only.

Highest channel:

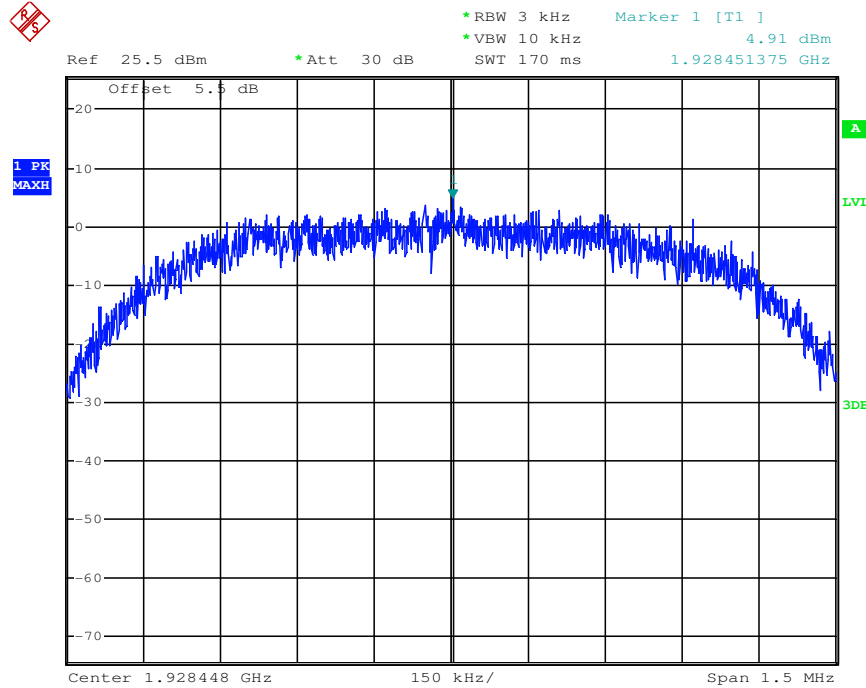

Date: 17.JUN.2019 12:09:55

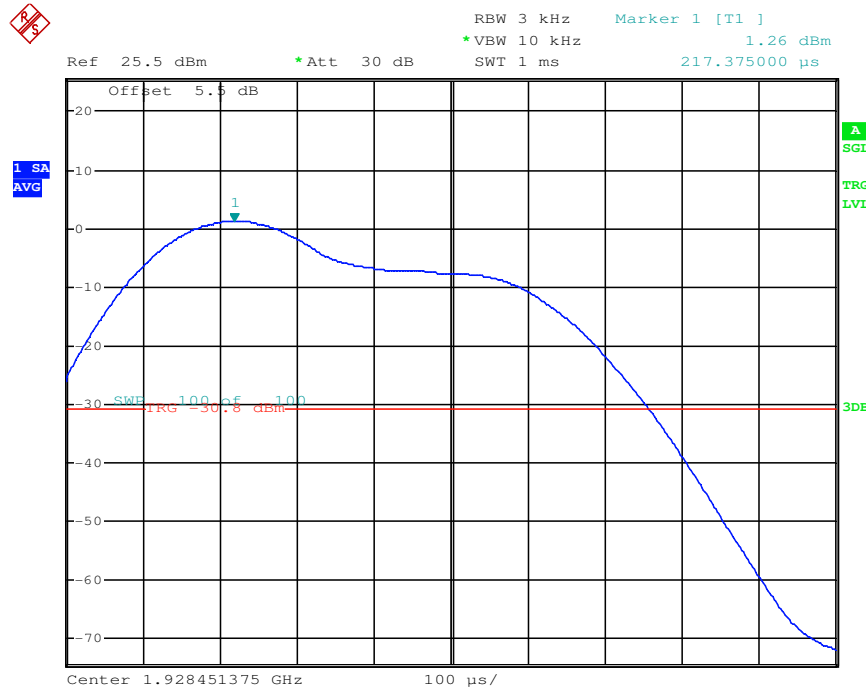

6.7 In-Band Unwanted Emissions, Conducted

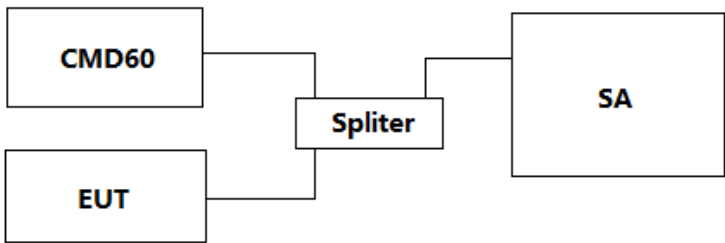
Test Requirement:	47 CFR Part 15.323(d)
Test Method:	ANSI C63.17: 2013
Limit:	B < f ≤ 2B : at least 30 dB below max. permitted peak power 2B < f ≤ 3B : at least 50 dB below max. permitted peak power 3B < f ≤ UPCS Band Edge : at least 60 dB below max. permitted peak power
Test Procedure:	RBW: Approximately 1% of the emission bandwidth (B) Video bandwidth: 3 × RBW Sweep time: The sweep time shall be sufficiently slow that the swept frequency rate shall not exceed one RBW per three transmit bursts. Number of sweeps: Sufficient to stabilize the trace Amplitude scale: Log Detection: Peak detection and max hold enabled Span: Approximately equal to 3.5 B
Test Setup:	 <pre> graph LR EUT[EUT] --- Splitter[Splitter] CMD60[CMD60] --- Splitter Splitter --- SA[SA] </pre>
Test Mode:	Transmitting mode
Instruments Used:	Refer to section 5.0 for details

Test Results:

Channel	Frequency (MHz)	Results
Lowest	1921.536	Pass
Middle	1924.992	Pass
Highest	1928.448	Pass

The plots of the unwanted emission inside the sub-band are as below.



Test Plot of In-Band Unwanted Emissions:
 Lowest channel:

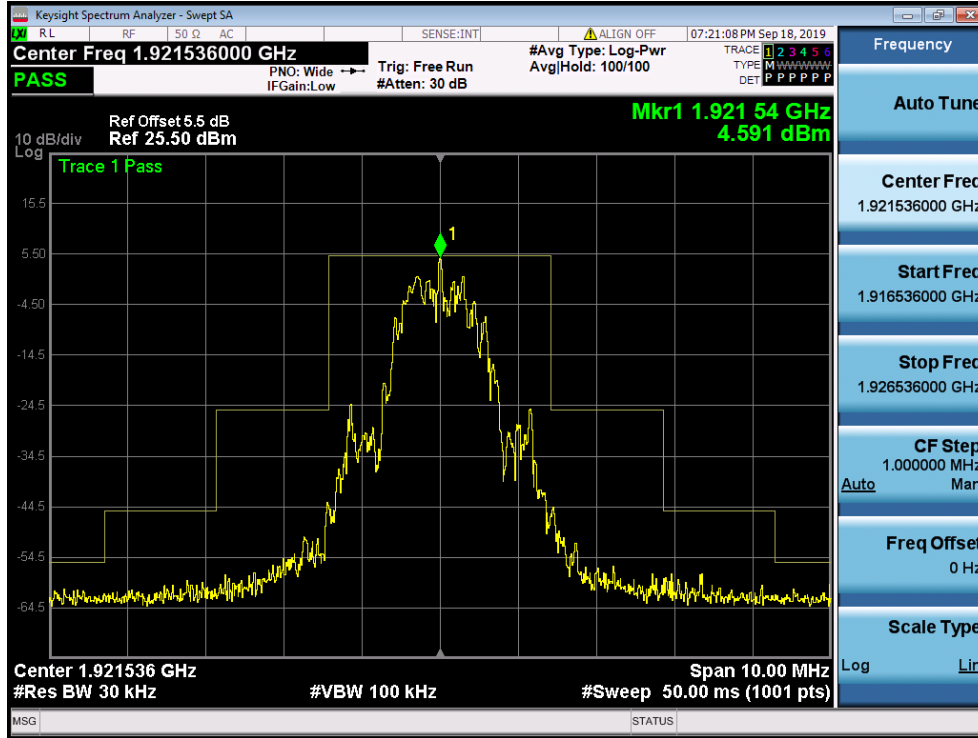

Middle channel:

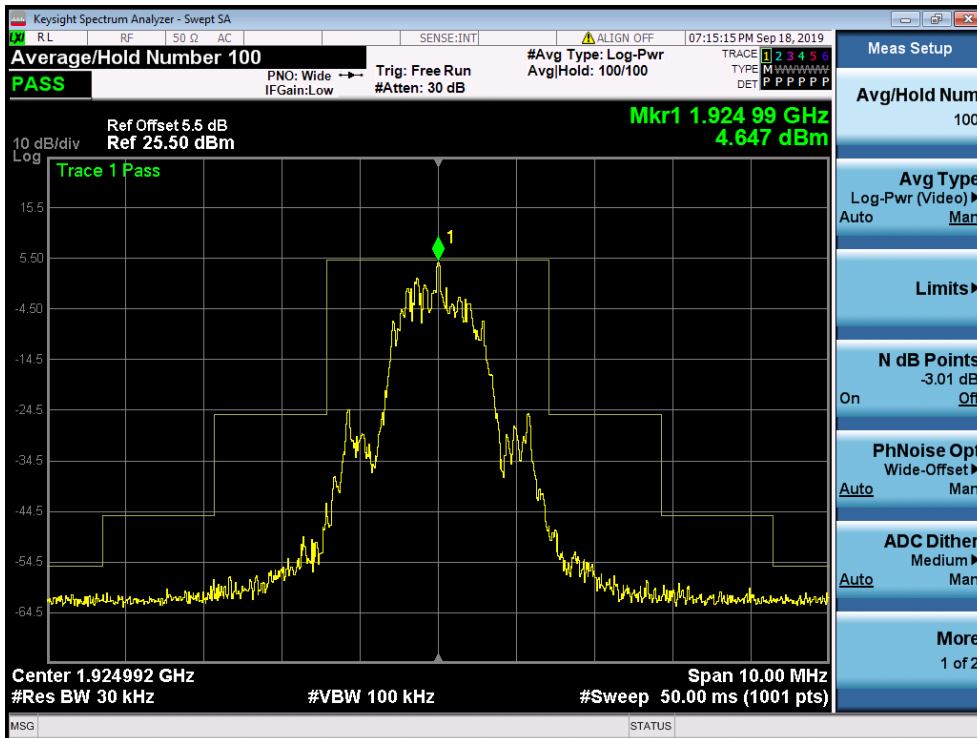

Unless otherwise agreed in writing, this document is issued by the Company subject to its General Conditions of Service printed overleaf, available on request or accessible at <http://www.sgs.com/en/Terms-and-Conditions.aspx> and, for electronic format documents, subject to Terms and Conditions for Electronic Documents at <http://www.sgs.com/en/Terms-and-Conditions/Terms-e-Documents.aspx>. Attention is drawn to the limitation of liability, indemnification and jurisdiction issues defined therein. Any holder of this document is advised that information contained hereon reflects the Company's findings at the time of its intervention only and within the limits of Client's instructions, if any. The Company's sole responsibility is to its Client and this document does not exonerate parties to a transaction from exercising all their rights and obligations under the transaction documents. This document cannot be reproduced except in full, without prior written approval of the Company. Any unauthorized alteration, forgery or falsification of the content or appearance of this document is unlawful and offenders may be prosecuted to the fullest extent of the law. Unless otherwise stated the results shown in this test report refer only to the sample(s) tested and such sample(s) are retained for 30 days only.
 Attention: To check the authenticity of testing /inspection report & certificate, please contact us at telephone: (86-755) 8307 1443, or email: CN.Doccheck@sgs.com

Highest channel:

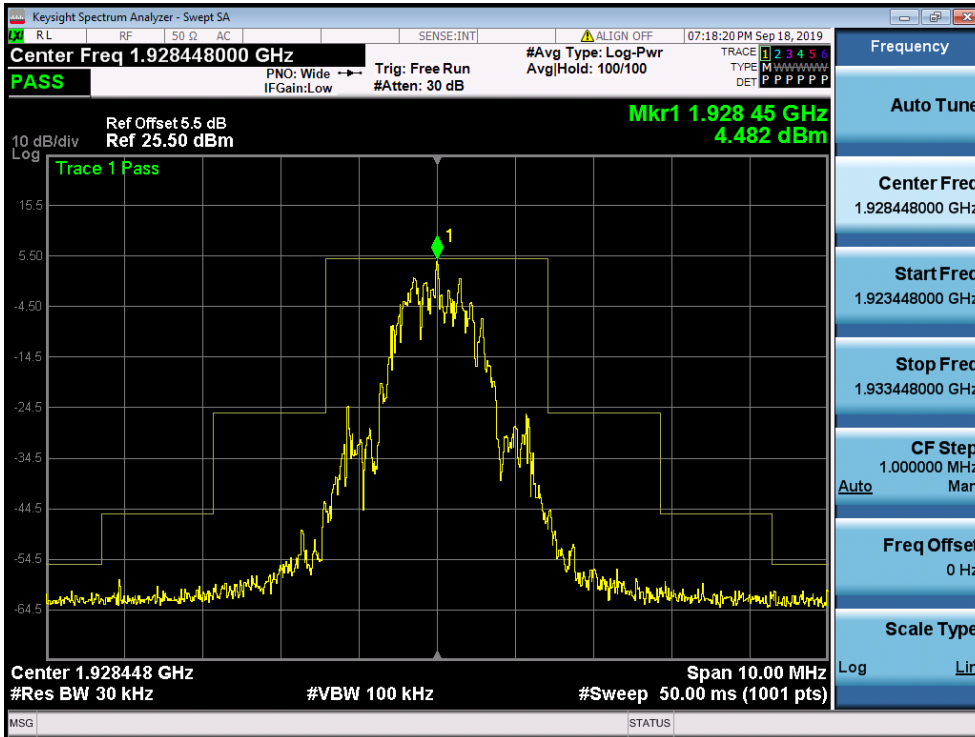

6.8 Out-of-band Emissions, Conducted

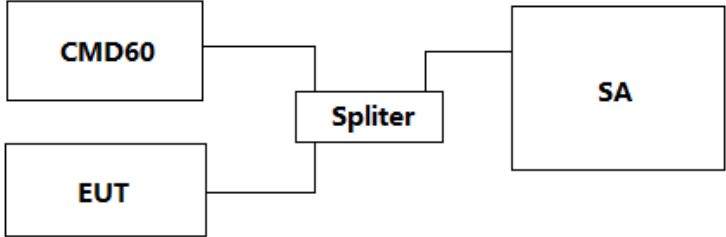
Test Requirement:	47 CFR Part 15.323(d)
Test Method:	ANSI C63.17: 2013
Limit:	$f \leq 1.25\text{MHz}$ outside UPCS band : $\leq -9.5\text{dBm}$ $1.25\text{MHz} \leq f \leq 2.5\text{MHz}$ outside UPCS band : $\leq -29.5\text{ dBm}$ $f \geq 2.5\text{MHz}$ outside UPCS band : $\leq -39.5\text{ dBm}$
Test Procedure:	RBW: Approximately 1% of the emission bandwidth (B) Video bandwidth: $3 \times \text{RBW}$ Sweep time: The sweep time shall be sufficiently slow that the swept frequency rate shall not exceed one RBW per three transmit bursts. Number of sweeps: Sufficient to stabilize the trace Amplitude scale: Log Detection: Peak detection and max hold enabled Span: Approximately equal to 3.5 B
Test Setup:	 <pre> graph LR CMD60[CMD60] --- Splitter[Splitter] EUT[EUT] --- Splitter Splitter --- SA[SA] </pre>
Test Mode:	Transmitting mode
Instruments Used:	Refer to section 5.0 for details

Test Results:

Channel	Frequency (MHz)	Results
Lowest	1921.536	Pass
Middle	1924.992	Pass
Highest	1928.448	Pass

The plots of the unwanted emission inside the sub-band are as below.



Test Plot of Out-of-Band Unwanted Emissions Lowest Channel:

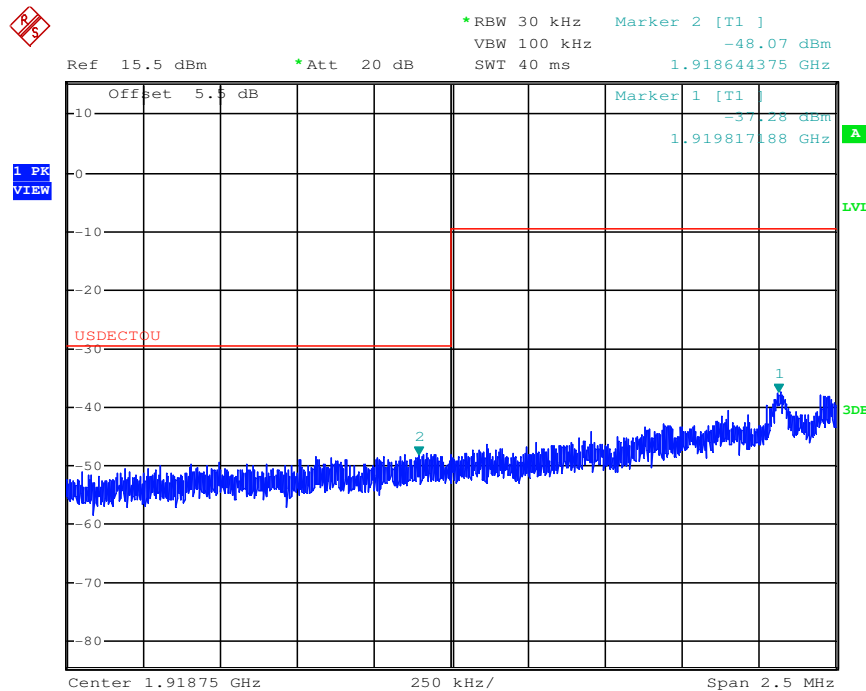
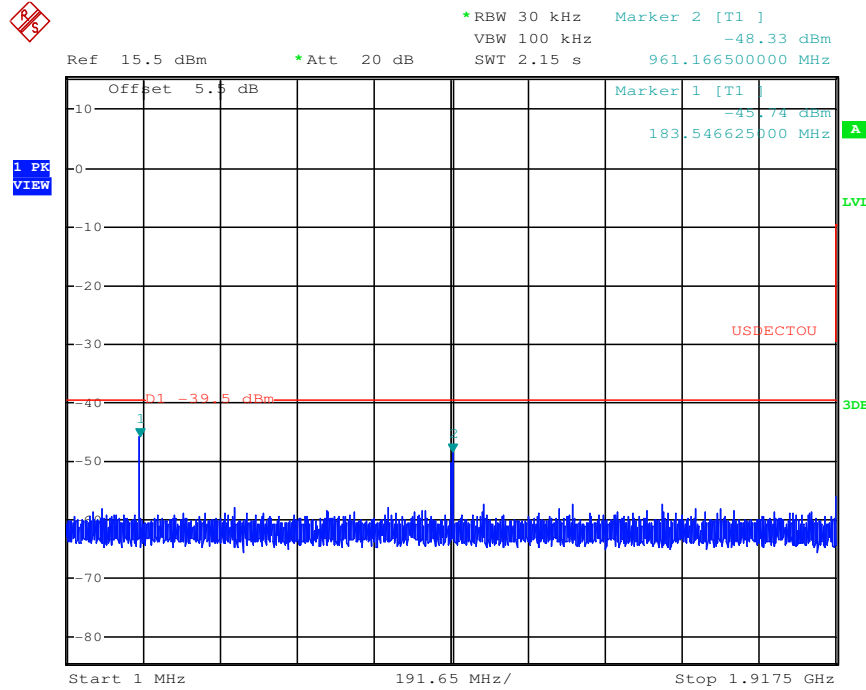

Unless otherwise agreed in writing, this document is issued by the Company subject to its General Conditions of Service printed overleaf, available on request or accessible at <http://www.sgs.com/en/Terms-and-Conditions.aspx> and, for electronic format documents, subject to Terms and Conditions for Electronic Documents at <http://www.sgs.com/en/Terms-and-Conditions/Terms-e-Documents.aspx>. Attention is drawn to the limitation of liability, indemnification and jurisdiction issues defined therein. Any holder of this document is advised that information contained hereon reflects the Company's findings at the time of its intervention only and within the limits of Client's instructions, if any. The Company's sole responsibility is to its Client and this document does not exonerate parties to a transaction from exercising all their rights and obligations under the transaction documents. This document cannot be reproduced except in full, without prior written approval of the Company. Any unauthorized alteration, forgery or falsification of the content or appearance of this document is unlawful and offenders may be prosecuted to the fullest extent of the law. Unless otherwise stated the results shown in this test report refer only to the sample(s) tested and such sample(s) are retained for 30 days only.

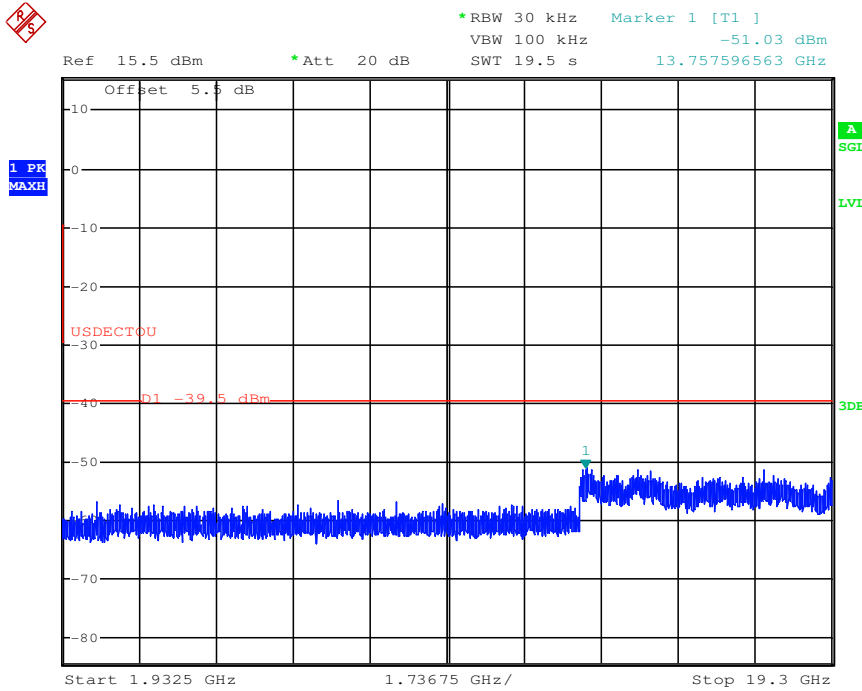

Test Plot of Out-of-Band Unwanted Emissions Highest Channel:

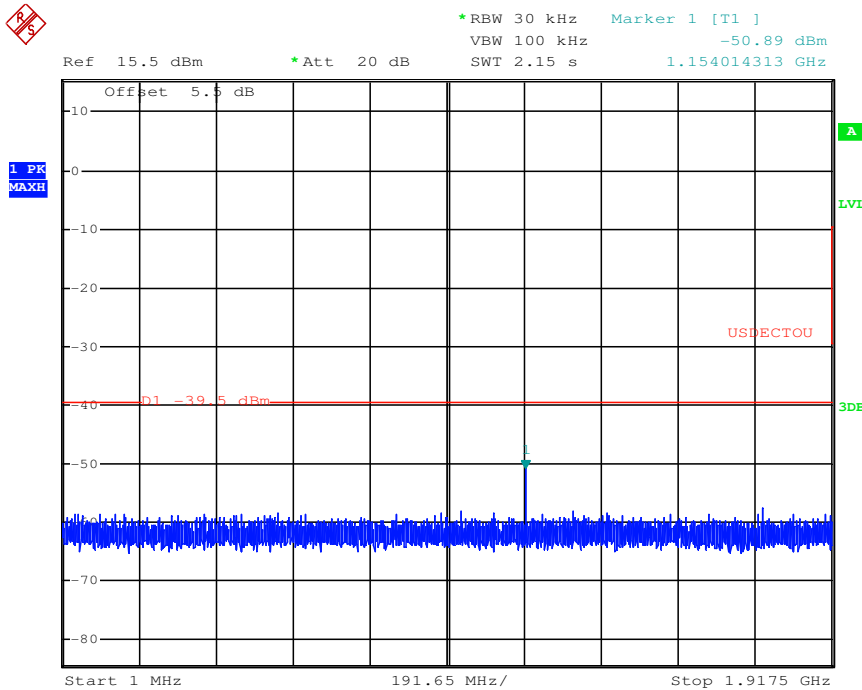

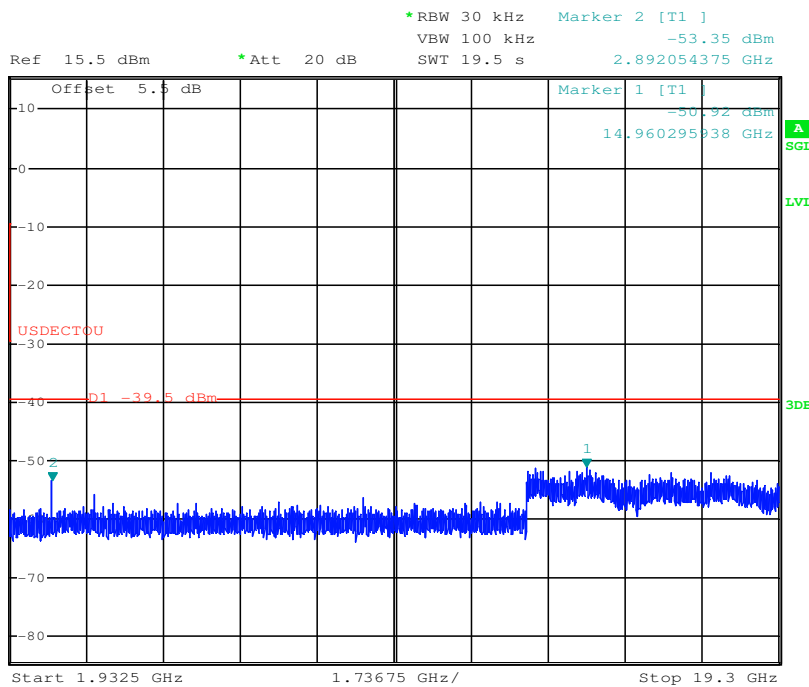
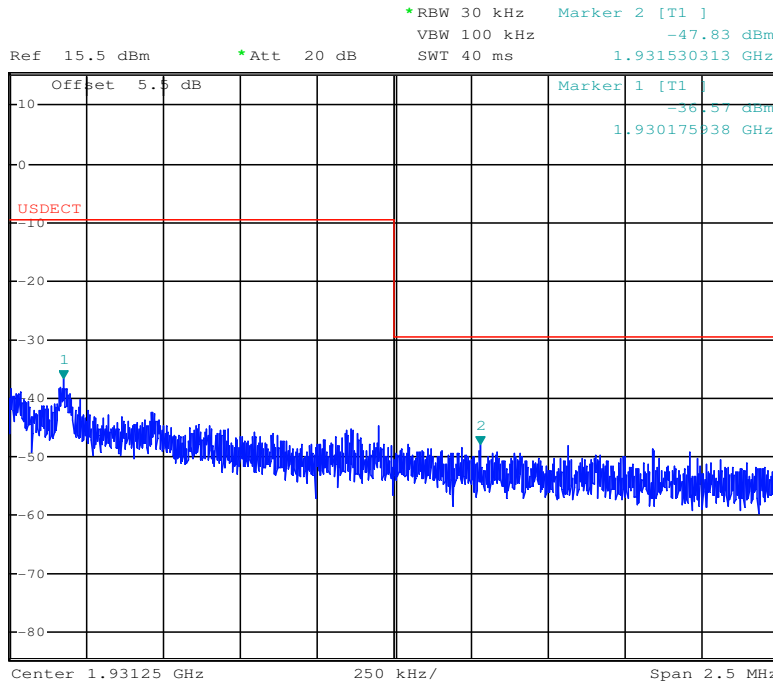

6.9 Carrier Frequency Stability

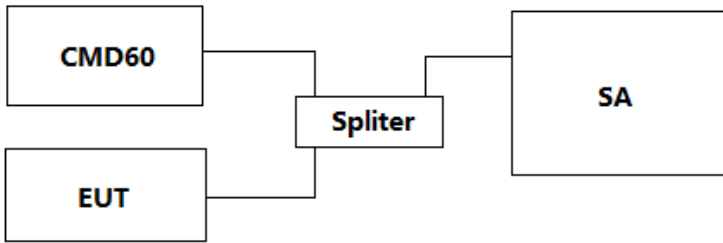
Test Requirement:	47 CFR Part 15.323(f)
Test Method:	ANSI C63.17: 2013
Limit:	maintained within +/-10 ppm at the following conditions: 1. Over 1 hour at nominal supply voltage and a temperature of +20 °C; 2. Over a variation in the primary supply voltage of 85 % to 115 % of nominal supply voltage at a temperature of +20 °C. This test does not apply to an EUT that is only powered by battery for operation; 3. Over a temperature variation of -20 °C to +50 °C or at extreme temperatures as declared by manufacturer, and at nominal supply voltage.
Test Procedure:	Measurements are made in accordance with ANSI C63.17 sub-clause 6.2.1 The EUT and CMD60 is connected with shielded coaxial cable. The EUT is controlled by DECT Radio Communication Tester, CMD60, to use a fixed frequency channel during test as well as record the frequency offset. The transmission of EUT is in burst mode with pseudo-random data.
Test Setup:	 <pre> graph LR CMD60[CMD60] --- Splitter[Splitter] EUT[EUT] --- Splitter Splitter --- SA[SA] </pre>
Test Mode:	Transmitting mode
Instruments Used:	Refer to section 5.0 for details

Test Results:

Carrier Frequency Stability over time at nominal temperature:

Average Mean Carrier Frequency (MHz)	Max. Diff. (kHz)	Min. Diff. (kHz)	Max. Dev. (ppm)	Limit(ppm)	Results
1924.991765	0.15	-0.31	0.2	±10	Pass

Carrier Frequency Stability over Power Supply Voltage at Nominal Temperature

Voltage	Measured Carrier Frequency (MHz)	Difference (kHz)	Deviation (ppm)	Limit(ppm)	Results
Vnom	1924.991569	0	0	±10	Pass
85% of Vnom	1924.991368	0.0	0.0	±10	Pass
115% of Vnom	1924.991134	0.0	0.0	±10	Pass



Unless otherwise agreed in writing, this document is issued by the Company subject to its General Conditions of Service printed overleaf, available on request or accessible at <http://www.sgs.com/en/Terms-and-Conditions.aspx> and, for electronic format documents, subject to Terms and Conditions for Electronic Documents at <http://www.sgs.com/en/Terms-and-Conditions/Terms-e-Documents.aspx>. Attention is drawn to the limitation of liability, indemnification and jurisdiction issues defined therein. Any holder of this document is advised that information contained hereon reflects the Company's findings at the time of its intervention only and within the limits of Client's instructions, if any. The Company's sole responsibility is to its Client and this document does not exonerate parties to a transaction from exercising all their rights and obligations under the transaction documents. This document cannot be reproduced except in full, without prior written approval of the Company. Any unauthorized alteration, forgery or falsification of the content or appearance of this document is unlawful and offenders may be prosecuted to the fullest extent of the law. Unless otherwise stated the results shown in this test report refer only to the sample(s) tested and such sample(s) are retained for 30 days only.
 Attention: To check the authenticity of testing /inspection report & certificate, please contact us at telephone: (86-755) 8307 1443, or email: CN.Doccheck@sgs.com

Carrier Frequency Stability over Temperature:

Temperature (°C)	Measured Carrier Frequency (MHz)	Difference (kHz)	Deviation (ppm)	Limit(ppm)	Results
-20°C	1924.991785	0.38	0.92	±10	Pass
+50°C	1924.991673	-0.65	-0.98	±10	Pass

6.10 Frame Repetition Stability

Test Requirement:	47 CFR Part 15.323(e)
Test Method:	ANSI C63.17: 2013
Limit:	<p>TDD: EUT that implement time division for the purpose of maintaining a duplex connection shall maintain a frame-repetition rate whereby three times the standard deviation of the frequency stability shall not exceed 50 ppm, not including a shift of the mean;</p> <p>TDMA: EUT that further divides access in time shall maintain a frame-repetition rate whereby three times the standard deviation of the frequency stability shall not exceed 10 ppm, not including a shift of the mean.</p>
Test Procedure:	<p>X axis: Time Time setting: Approximate frame period × 100 Y axis: Frequency Center frequency: Nominal frame-repetition rate Frequency span: Span large enough so that the full waveform is greater than 50% but less than 100% of the display scale Measurement time interval (gating time) :X (in units of frame period) where X ≤ 1000 Number of measurements: 1000/X (where X is the measurement interval in units of frame period)</p>
Test Setup:	<pre> graph LR EUT[EUT] --- Splitter[Splitter] CMD60[CMD60] --- Splitter Splitter --- SA[SA] </pre>
Test Mode:	Transmitting mode
Instruments Used:	Refer to section 5.0 for details

Test Results:

Carrier Frequency (MHz)	Mean (Hz)	Standard Deviation (μHz)	Frame Repetition Stability (ppm)	Limit (ppm)	Results
1924.992	100.000	1.189	0.035	±10	Pass



Unless otherwise agreed in writing, this document is issued by the Company subject to its General Conditions of Service printed overleaf, available on request or accessible at <http://www.sgs.com/en/Terms-and-Conditions.aspx> and, for electronic format documents, subject to Terms and Conditions for Electronic Documents at <http://www.sgs.com/en/Terms-and-Conditions/Terms-e-Documents.aspx>. Attention is drawn to the limitation of liability, indemnification and jurisdiction issues defined therein. Any holder of this document is advised that information contained hereon reflects the Company's findings at the time of its intervention only and within the limits of Client's instructions, if any. The Company's sole responsibility is to its Client and this document does not exonerate parties to a transaction from exercising all their rights and obligations under the transaction documents. This document cannot be reproduced except in full, without prior written approval of the Company. Any unauthorized alteration, forgery or falsification of the content or appearance of this document is unlawful and offenders may be prosecuted to the fullest extent of the law. Unless otherwise stated the results shown in this test report refer only to the sample(s) tested and such sample(s) are retained for 30 days only.
Attention: To check the authenticity of testing/inspection report & certificate, please contact us at telephone: (86-755) 8307 1443, or email: CN.Doccheck@sgs.com

6.11 Frame Period and Jitter

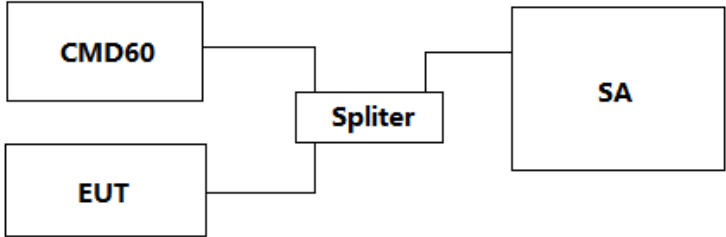
Test Requirement:	47 CFR Part 15.323(e)		
Test Method:	ANSI C63.17: 2013		
Limit:	Frame Period	20 or 10 ms	
	Max Jitter	25 μ s	
	3 times St.Dev of Jitter	12.5 μ s	
Test Procedure:	Measurements are made in accordance with ANSI C63.17 sub-clause 6.2.3. Test setup is shown in section 3.2 Figure 3.2.1. A spectrum analyzer measures the time duration between the rising edges of two consecutive frames. The measurements are taken over 100,000 frames. These measurement values are used to compute mean value and the difference between any two consecutive frame periods. The mean value is the frame period.		
Test Setup:	 <pre> graph LR CMD60[CMD60] --- Splitter[Splitter] EUT[EUT] --- Splitter Splitter --- SA[SA] </pre>		
Test Mode:	Transmitting mode		
Instruments Used:	Refer to section 5.0 for details		

Test Results:

Measured Maximum Jitter (μ s)	Limit (μ s)	Results
-0.195	\pm 25	Pass



6.12 Monitoring Threshold, Least Interfered Channel

Test Requirement:	47 CFR Part 15.323(c)(2)(5)(9)
Test Method:	ANSI C63.17: 2013
Limit:	Least Interfered Channel Procedure (LIC) may only be used by systems with more than 20 duplex system access channels. Systems with less than 20 duplex system access channels are not allowed to transmit when interferer level is above Lower Threshold.
Test Procedure:	Please refer to accordance with ANSI C63.17 Clause 7.3.1, 7.3.3, 7.3.4
Test Setup:	
Test Mode:	Transmitting mode
Instruments Used:	Refer to section 5.0 for details

Calculation of Monitoring Threshold Limit:

$$\text{Monitoring Threshold (T)} \leq -174 + 10 \log_{10} B + M + P_{\max} - P_{\text{EUT}} \text{ dBm}$$

$$\leq 15 \log_{10} B - 184 + M - P_{\text{EUT}} \text{ dBm}$$

- Where
- B = Measured Emission Bandwidth: 1.48×10^6 Hz
 - M = 30 dB for Lower Monitoring Threshold (T_L), or
 = 50 dB for Upper Monitoring Threshold (T_U)
 - P_{\max} = $5 \log_{10} B - 10$ dBm
 - P_{EUT} = Measured Peak Transmit Power: 20.04 dBm

Monitoring Threshold Limits:

	FCC
Lower Monitoring Threshold ($T_L + U_M$) in dBm	-81.5
Upper Monitoring Threshold ($T_U + U_M$) in dBm	-61.5

NA - Not applicable



Test Descriptions and Results:

Least Interfered Channel (LIC) Procedure Test, FCC 15.323(b), (c)(2) and (c)(5)

ANSI C63.17 clause 7.3.2 ref.	Observation	Results
b) f1 at TL + UM + 7 dB, f2 at TL + UM	Transmission always on f2	Pass
c) f1 at TL + UM, f2 at TL + UM +7 dB	Transmission always on f1	Pass
d) f1 at TL + UM + 1 dB, f2 at TL + UM - 6 dB	Transmission always on f2	Pass
e) f1 at TL + UM - 6 dB, f2 at TL + UM + 1 dB	Transmission always on f1	Pass

NA - Not applicable

Selected Channel Confirmation, FCC 15.323(c)(1) and (5)

ANSI C63.17 clause 7.3.3	Observation	Results
b) Shall not transmit on f1	EUT transmits on f2	Pass
d) Shall not transmit on f2	EUT transmits on f1	Pass



Unless otherwise agreed in writing, this document is issued by the Company subject to its General Conditions of Service printed overleaf, available on request or accessible at <http://www.sgs.com/en/Terms-and-Conditions.aspx> and, for electronic format documents, subject to Terms and Conditions for Electronic Documents at <http://www.sgs.com/en/Terms-and-Conditions/Terms-e-Documents.aspx>. Attention is drawn to the limitation of liability, indemnification and jurisdiction issues defined therein. Any holder of this document is advised that information contained hereon reflects the Company's findings at the time of its intervention only and within the limits of Client's instructions, if any. The Company's sole responsibility is to its Client and this document does not exonerate parties to a transaction from exercising all their rights and obligations under the transaction documents. This document cannot be reproduced except in full, without prior written approval of the Company. Any unauthorized alteration, forgery or falsification of the content or appearance of this document is unlawful and offenders may be prosecuted to the fullest extent of the law. Unless otherwise stated the results shown in this test report refer only to the sample(s) tested and such sample(s) are retained for 30 days only.
Attention: To check the authenticity of testing /inspection report & certificate, please contact us at telephone: (86-755) 8307 1443, or email: CN.Doccheck@sgs.com

6.13 Threshold Monitoring Bandwidth

Test Requirement:	47 CFR Part 15.323(c)(7), RSS-213 5.2 (7)
Test Method:	ANSI C63.17: 2013
Limit:	The monitoring system bandwidth must be equal to or greater than the emission bandwidth of the intended transmission.
Test Procedure:	Please refer to accordance with ANSI C63.17 Clause 7.4.1
Test Setup:	
Test Mode:	Transmitting mode
Instruments Used:	Refer to section 5.0 for details

Test Results:

Test performed	Observation	Results
Simple Compliance test, at $\pm 30\%$ of B	N/A	N/A
More Detailed Test, at ± 6 dB points	N/A	N/A
More Detailed Test, at ± 12 dB points	N/A	N/A

NA – Not applicable

*Remarks: Detailed Compliance Test was used to show the compliance of the EUT.



Unless otherwise agreed in writing, this document is issued by the Company subject to its General Conditions of Service printed overleaf, available on request or accessible at <http://www.sgs.com/en/Terms-and-Conditions.aspx> and, for electronic format documents, subject to Terms and Conditions for Electronic Documents at <http://www.sgs.com/en/Terms-and-Conditions/Terms-e-Documents.aspx>. Attention is drawn to the limitation of liability, indemnification and jurisdiction issues defined therein. Any holder of this document is advised that information contained hereon reflects the Company's findings at the time of its intervention only and within the limits of Client's instructions, if any. The Company's sole responsibility is to its Client and this document does not exonerate parties to a transaction from exercising all their rights and obligations under the transaction documents. This document cannot be reproduced except in full, without prior written approval of the Company. Any unauthorized alteration, forgery or falsification of the content or appearance of this document is unlawful and offenders may be prosecuted to the fullest extent of the law. Unless otherwise stated the results shown in this test report refer only to the sample(s) tested and such sample(s) are retained for 30 days only.
 Attention: To check the authenticity of testing /inspection report & certificate, please contact us at telephone: (86-755) 8307 1443, or email: CN.Doccheck@sgs.com

6.14 Reaction Time and Monitoring Interval

Test Requirement:	47 CFR Part 15.323(c) (1) (5) (7)
Test Method:	ANSI C63.17: 2013
Limit:	The maximum reaction time must be required to be less than 50 μ s. If a signal is detected that is 6 dB or more above the applicable threshold level, the maximum reaction time shall not be required to be less than 35 μ s.
Test Procedure:	Please refer to accordance with ANSI C63.17 Clause 7.5
Test Setup:	
Test Mode:	Transmitting mode
Instruments Used:	Refer to section 5.0 for details

Test Results:

Pulse Width, ref. to ANSI C63.17 clause 7.5	Observation	Results
c) > largest of 50 μ s	EUT transmits on f1	Pass
d) > largest of 35 μ s	EUT transmits on f1	Pass

Comment: Since B is larger than 1.25 MHz the test was performed with pulse lengths of 50 μ s and 35 μ s.



Unless otherwise agreed in writing, this document is issued by the Company subject to its General Conditions of Service printed overleaf, available on request or accessible at <http://www.sgs.com/en/Terms-and-Conditions.aspx> and, for electronic format documents, subject to Terms and Conditions for Electronic Documents at <http://www.sgs.com/en/Terms-and-Conditions/Terms-e-Documents.aspx>. Attention is drawn to the limitation of liability, indemnification and jurisdiction issues defined therein. Any holder of this document is advised that information contained hereon reflects the Company's findings at the time of its intervention only and within the limits of Client's instructions, if any. The Company's sole responsibility is to its Client and this document does not exonerate parties to a transaction from exercising all their rights and obligations under the transaction documents. This document cannot be reproduced except in full, without prior written approval of the Company. Any unauthorized alteration, forgery or falsification of the content or appearance of this document is unlawful and offenders may be prosecuted to the fullest extent of the law. Unless otherwise stated the results shown in this test report refer only to the sample(s) tested and such sample(s) are retained for 30 days only.
 Attention: To check the authenticity of testing /inspection report & certificate, please contact us at telephone: (86-755) 8307 1443, or email: CN.Doccheck@sgs.com

6.15 Time and Spectrum Window Access Procedure

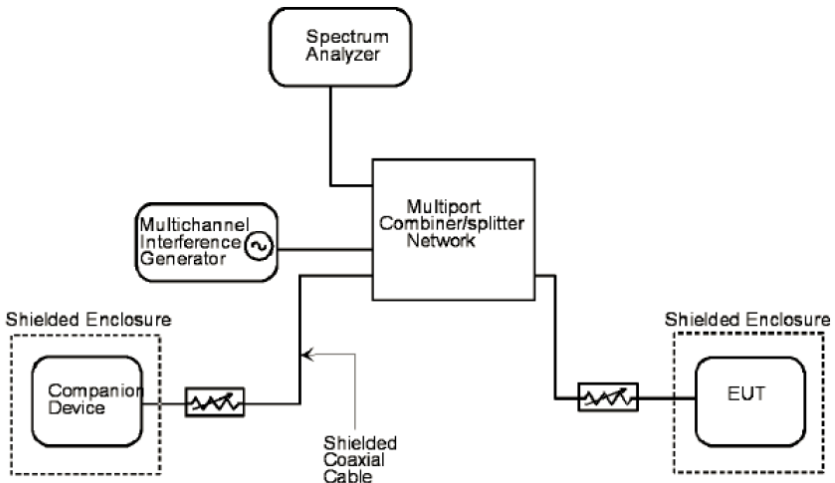
Test Requirement:	47 CFR Part 15.323(c) (4) (6)
Test Method:	ANSI C63.17: 2013
Limit:	<p>Once access to specific combined time and spectrum windows is obtained an acknowledgment from a system participant must be received by the initiating transmitter within one second or transmission must cease. Periodic acknowledgments must be received at least every 30 seconds or transmission must cease. Channels used exclusively for control and signaling information may transmit continuously for 30 seconds without receiving an acknowledgment, at which time the access criteria must be repeated.</p> <p>If the selected combined time and spectrum windows are unavailable, the device may either monitor and select different windows or seek to use the same windows after waiting an amount of time, randomly chosen from a uniform random distribution between 10 and 150 milliseconds, commencing when the channel becomes available.</p>
Test Procedure:	Please refer to accordance with ANSI C63.17 Clause 8.1.1, 8.2.1; 8.1.2 or 8.1.3.
Test Setup:	
Test Mode:	Transmitting mode
Instruments Used:	Refer to section 5.0 for details



Unless otherwise agreed in writing, this document is issued by the Company subject to its General Conditions of Service printed overleaf, available on request or accessible at <http://www.sgs.com/en/Terms-and-Conditions.aspx> and, for electronic format documents, subject to Terms and Conditions for Electronic Documents at <http://www.sgs.com/en/Terms-and-Conditions/Terms-e-Documents.aspx>. Attention is drawn to the limitation of liability, indemnification and jurisdiction issues defined therein. Any holder of this document is advised that information contained hereon reflects the Company's findings at the time of its intervention only and within the limits of Client's instructions, if any. The Company's sole responsibility is to its Client and this document does not exonerate parties to a transaction from exercising all their rights and obligations under the transaction documents. This document cannot be reproduced except in full, without prior written approval of the Company. Any unauthorized alteration, forgery or falsification of the content or appearance of this document is unlawful and offenders may be prosecuted to the fullest extent of the law. Unless otherwise stated the results shown in this test report refer only to the sample(s) tested and such sample(s) are retained for 30 days only.
 Attention: To check the authenticity of testing /inspection report & certificate, please contact us at telephone: (86-755) 8307 1443, or email: CN.Doccheck@sgs.com

Test results:

Access Criteria, ref. to ANSI C63.17 clause 8.1.1, 8.2.1	Observation	Results
b) Check that the EUT transmits on the interference free time-slot	EUT transmits on the interference free time-slot	Pass
b) The EUT must terminate or pause in its repetitive transmission of the control and signalling channel on the open channel to repeat the access criteria not less frequently than every 30 s	Transmission paused every 1.12 s	Pass

If FCC 15.323(c)(6) option, If Random Waiting Interval is NOT implemented

Access Criteria, ref. to ANSI C63.17 clause 8.1.2	Observation	Results
b) Check that the EUT changes to an interference-free slot when interference is introduced on the time slot in use	EUT changes to the interference-free time-slot, and stays there	Pass

If FCC 15.323(c)(6) option, Only if Random Waiting Interval is implemented

Access Criteria, ref. to ANSI C63.17 clause 8.1.3	Observation	Results
b-d) Check that the EUT uses random waiting interval before continuing transmission on an interfered time slot	N/A	N/A

Comment: The tested EUT does not support the Random Waiting Interval option.



Unless otherwise agreed in writing, this document is issued by the Company subject to its General Conditions of Service printed overleaf, available on request or accessible at <http://www.sgs.com/en/Terms-and-Conditions.aspx> and, for electronic format documents, subject to Terms and Conditions for Electronic Documents at <http://www.sgs.com/en/Terms-and-Conditions/Terms-e-Documents.aspx>. Attention is drawn to the limitation of liability, indemnification and jurisdiction issues defined therein. Any holder of this document is advised that information contained hereon reflects the Company's findings at the time of its intervention only and within the limits of Client's instructions, if any. The Company's sole responsibility is to its Client and this document does not exonerate parties to a transaction from exercising all their rights and obligations under the transaction documents. This document cannot be reproduced except in full, without prior written approval of the Company. Any unauthorized alteration, forgery or falsification of the content or appearance of this document is unlawful and offenders may be prosecuted to the fullest extent of the law. Unless otherwise stated the results shown in this test report refer only to the sample(s) tested and such sample(s) are retained for 30 days only.
Attention: To check the authenticity of testing /inspection report & certificate, please contact us at telephone: (86-755) 8307 1443, or email: CN.Doccheck@sgs.com

6.16 Acknowledgements and Transmission Duration

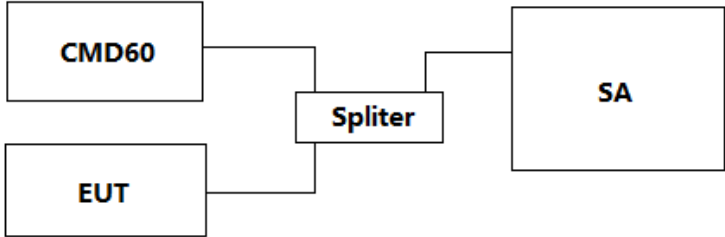
Test Requirement:	47 CFR Part 15.323(c) (3) (4)
Test Method:	ANSI C63.17: 2013
Limit:	<p>Occupation of the same combined time and spectrum windows by a device or group of cooperating devices continuously over a period of time longer than 8 hours is not permitted without repeating the access criteria.</p> <p>Once access to specific combined time and spectrum windows is obtained an acknowledgement from a system participant must be received by the initiating transmitter within one second or transmission must cease.</p> <p>Periodic acknowledgements must be received at least every 30 seconds or transmission must cease. Channels used exclusively for control and signaling information may transmit continuously for 30 seconds without receiving an acknowledgement, at which time the access criteria must be repeated.</p>
Test Procedure:	Please refer to accordance with ANSI C63.17 Clause 8.2
Test Setup:	 <pre> graph LR CMD60[CMD60] --- Splitter[Splitter] EUT[EUT] --- Splitter Splitter --- SA[SA] </pre>
Test Mode:	Transmitting mode
Instruments Used:	Refer to section 5.0 for details



Unless otherwise agreed in writing, this document is issued by the Company subject to its General Conditions of Service printed overleaf, available on request or accessible at <http://www.sgs.com/en/Terms-and-Conditions.aspx> and, for electronic format documents, subject to Terms and Conditions for Electronic Documents at <http://www.sgs.com/en/Terms-and-Conditions/Terms-e-Documents.aspx>. Attention is drawn to the limitation of liability, indemnification and jurisdiction issues defined therein. Any holder of this document is advised that information contained hereon reflects the Company's findings at the time of its intervention only and within the limits of Client's instructions, if any. The Company's sole responsibility is to its Client and this document does not exonerate parties to a transaction from exercising all their rights and obligations under the transaction documents. This document cannot be reproduced except in full, without prior written approval of the Company. Any unauthorized alteration, forgery or falsification of the content or appearance of this document is unlawful and offenders may be prosecuted to the fullest extent of the law. Unless otherwise stated the results shown in this test report refer only to the sample(s) tested and such sample(s) are retained for 30 days only.

Attention: To check the authenticity of testing /inspection report & certificate, please contact us at telephone: (86-755) 8307 1443, or email: CN.Doccheck@sgs.com

Test results:

Acknowledgements

Timing for EUTs using control and signaling channel type transmissions:

Conditions	Transmission Duration (seconds)	Limit (seconds)	Results
Time needed to repeat access criteria	2	30	Pass

Timing for EUTs using communications channel type transmissions:

Conditions	Transmission Duration (seconds)	Limit (seconds)	Results
Activate EUT w/ companion device off	NA	1	NA
Time needed to cease Traffic Channel	4.2	30	Pass

NA - Not applicable

Transmission Duration

Measured Maximum Transmission Duration (minutes)	Limit (minutes)	Results
230	480	Pass



Unless otherwise agreed in writing, this document is issued by the Company subject to its General Conditions of Service printed overleaf, available on request or accessible at <http://www.sgs.com/en/Terms-and-Conditions.aspx> and, for electronic format documents, subject to Terms and Conditions for Electronic Documents at <http://www.sgs.com/en/Terms-and-Conditions/Terms-e-Documents.aspx>. Attention is drawn to the limitation of liability, indemnification and jurisdiction issues defined therein. Any holder of this document is advised that information contained hereon reflects the Company's findings at the time of its intervention only and within the limits of Client's instructions, if any. The Company's sole responsibility is to its Client and this document does not exonerate parties to a transaction from exercising all their rights and obligations under the transaction documents. This document cannot be reproduced except in full, without prior written approval of the Company. Any unauthorized alteration, forgery or falsification of the content or appearance of this document is unlawful and offenders may be prosecuted to the fullest extent of the law. Unless otherwise stated the results shown in this test report refer only to the sample(s) tested and such sample(s) are retained for 30 days only.

6.17 Dual Access Criteria Check

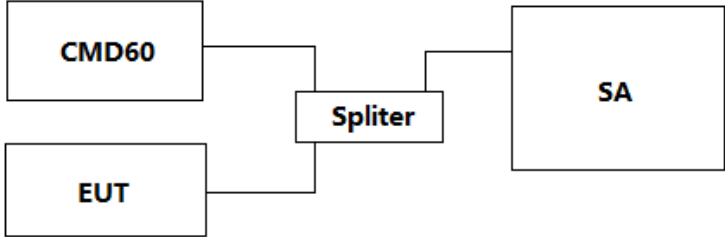
Test Requirement:	47 CFR Part 15.323(c) (10) , RSS-213 5.2 (10)
Test Method:	ANSI C63.17: 2013
Limit:	An initiating device may attempt to establish a duplex connection by monitoring both its intended transmit and receive time and spectrum windows. If both the intended transmit and receive time and spectrum windows meet the access criteria, then the initiating device can initiate a transmission in the intended transmit time and spectrum window. If the power detected by the responding device can be decoded as a duplex connection signal from the initiating device, then the responding device may immediately begin transmitting on the receive time and spectrum window monitored by the initiating device.
Test Procedure:	Please refer to accordance with ANSI C63.17 Clause 8.3
Test Setup:	 <pre> graph LR CMD60[CMD60] --- Splitter[Splitter] EUT[EUT] --- Splitter Splitter --- SA[SA] </pre>
Test Mode:	Transmitting mode
Instruments Used:	Refer to section 5.0 for details

Test results:

EUTs that implements the LIC procedure:

Test ref. to ANSI C63.17 clause 8.3.2	Observation	Results
b) EUT is restricted to a single carrier f1 for TDMA systems. The Test is Pass if EUT can transmit	EUT can transmit	Pass
c) d) Transmission on interference-free receive time/spectrum window	EUT transmits on interference free receive slot	Pass
e) f) Transmission on interference-free transmit time/spectrum window	EUT transmits on interference free transmit slot	Pass



6.18 Radiated Spurious Emissions

Test Requirement:	47 CFR Part 15.319(g), 15.209(a)				
Test Method:	ANSI C63.4: 2014				
Test Site:	Measurement Distance: 3m (Semi-Anechoic Chamber)				
Receiver Setup:	Frequency	Detector	RBW	VBW	Remark
	0.009MHz-0.090MHz	Peak	10kHz	30kHz	Peak
	0.009MHz-0.090MHz	Average	10kHz	30kHz	Average
	0.090MHz-0.110MHz	Quasi-peak	10kHz	30kHz	Quasi-peak
	0.110MHz-0.490MHz	Peak	10kHz	30kHz	Peak
	0.110MHz-0.490MHz	Average	10kHz	30kHz	Average
	0.490MHz -30MHz	Quasi-peak	10kHz	30kHz	Quasi-peak
	30MHz-960MHz	Quasi-peak	100 kHz	300kHz	Quasi-peak
	Above 960MHz	RMS	1MHz	3MHz	RMS
Limit: (Spurious Emissions)	$f \leq 1.25\text{MHz}$ outside UPCS band : $\leq -9.5\text{dBm}$ $1.25\text{MHz} \leq f \leq 2.5\text{MHz}$ outside UPCS band : $\leq -29.5\text{dBm}$ $f \geq 2.5\text{MHz}$ outside UPCS band : $\leq -39.5\text{dBm}$ or shall meet the requirement of FCC Rule 15.319(g) which shall not exceed the limits of FCC Rule 15.209				



Unless otherwise agreed in writing, this document is issued by the Company subject to its General Conditions of Service printed overleaf, available on request or accessible at <http://www.sgs.com/en/Terms-and-Conditions.aspx> and, for electronic format documents, subject to Terms and Conditions for Electronic Documents at <http://www.sgs.com/en/Terms-and-Conditions/Terms-e-Documents.aspx>. Attention is drawn to the limitation of liability, indemnification and jurisdiction issues defined therein. Any holder of this document is advised that information contained hereon reflects the Company's findings at the time of its intervention only and within the limits of Client's instructions, if any. The Company's sole responsibility is to its Client and this document does not exonerate parties to a transaction from exercising all their rights and obligations under the transaction documents. This document cannot be reproduced except in full, without prior written approval of the Company. Any unauthorized alteration, forgery or falsification of the content or appearance of this document is unlawful and offenders may be prosecuted to the fullest extent of the law. Unless otherwise stated the results shown in this test report refer only to the sample(s) tested and such sample(s) are retained for 30 days only.
 Attention: To check the authenticity of testing /inspection report & certificate, please contact us at telephone: (86-755) 8307 1443, or email: CN.Doccheck@sgs.com

Test Setup:	
<p>Figure 1. Below 30MHz</p>	<p>Figure 2. 30MHz to 1GHz</p>
Test Procedure:	<p>Figure 3. Above 1 GHz</p> <ol style="list-style-type: none"> 1) For below 1GHz, the EUT was placed on the top of a rotating table 0.8 meters above the ground at a 3 meter semi-anechoic chamber. The table was rotated 360 degrees to determine the position of the highest radiation. 2) For above 1GHz, the EUT was placed on the top of a rotating table 1.5 meters above the ground at a 3 meter semi-anechoic chamber. The table was rotated 360 degrees to determine the position of the highest radiation. 3) The EUT was set 3 meters away from the interference-receiving antenna, which was mounted on the top of a variable-height antenna tower. 4) The antenna height is varied from one meter to four meters above the ground to determine the maximum value of the field strength. Both horizontal and vertical polarizations of the antenna are set to make the measurement. 5) For each suspected emission, the EUT was arranged to its worst case and then the antenna was tuned to heights from 1 meter to 4 meters (for the test frequency of below 30MHz, the antenna was tuned to heights 1 meter) and the rotatable table was turned from 0 degrees to



	<p>360 degrees to find the maximum reading.</p> <p>6) The test-receiver system was set to Peak Detect Function and Specified Bandwidth with Maximum Hold Mode.</p> <p>7) If the emission level of the EUT in peak mode was 10dB lower than the limit specified, then testing could be stopped and the peak values of the EUT would be reported. Otherwise the emissions that did not have 10dB margin would be re-tested one by one using peak, quasi-peak or average method as specified and then reported in a data sheet.</p> <p>8) Test the EUT in the lowest channel,the middle channel,the Highest channel</p> <p>9) The radiation measurements are performed in X, Y, Z axis positioning for Transmitting mode,And found the X axis positioning which it is worse case.</p> <p>10) Repeat above procedures until all frequencies measured was complete.</p>
Exploratory Test Mode:	Transmitting mode
Final Test Mode:	Pretest the EUT at Transmitting mode and Charge +Transmitting mode, found the Charge +Transmitting mode which it is worse case Only the worst case is recorded in the report.
Instruments Used:	Refer to section 5.0 for details

Test Data:

Below 1GHz:

Polarization	Frequency (MHz)	Measured Power (dBm)	Power Limit (dBm)	Margin (dBm)
H	30.10	-65.43	-39.5	-25.93
H	591.23	-66.54	-39.5	-27.04
H	780.65	-65.53	-39.5	-26.03
V	30.11	-64.23	-39.5	-24.73
V	561.58	-65.57	-39.5	-26.07
V	780.98	-66.12	-39.5	-26.62

Above 1GHz:

Lowest Channel:

Polarization	Frequency (MHz)	Measured Power (dBm)	Power Limit (dBm)	Margin (dBm)
H	3843.072	-56.3	-39.5	-16.8
H	5764.608	-51.85	-39.5	-12.35
H	7686.144	-50.15	-39.5	-10.65
V	3843.072	-55.95	-39.5	-16.45
V	5764.608	-51.44	-39.5	-11.94
V	7686.144	-49.58	-39.5	-10.08



Unless otherwise agreed in writing, this document is issued by the Company subject to its General Conditions of Service printed overleaf, available on request or accessible at <http://www.sgs.com/en/Terms-and-Conditions.aspx> and, for electronic format documents, subject to Terms and Conditions for Electronic Documents at <http://www.sgs.com/en/Terms-and-Conditions/Terms-e-Documents.aspx>. Attention is drawn to the limitation of liability, indemnification and jurisdiction issues defined therein. Any holder of this document is advised that information contained hereon reflects the Company's findings at the time of its intervention only and within the limits of Client's instructions, if any. The Company's sole responsibility is to its Client and this document does not exonerate parties to a transaction from exercising all their rights and obligations under the transaction documents. This document cannot be reproduced except in full, without prior written approval of the Company. Any unauthorized alteration, forgery or falsification of the content or appearance of this document is unlawful and offenders may be prosecuted to the fullest extent of the law. Unless otherwise stated the results shown in this test report refer only to the sample(s) tested and such sample(s) are retained for 30 days only.
 Attention: To check the authenticity of testing /inspection report & certificate, please contact us at telephone: (86-755) 8307 1443, or email: CN.Doccheck@sgs.com

Middle Channel:

Polarization	Frequency (MHz)	Measured Power (dBm)	Power Limit (dBm)	Margin (dBm)
H	3849.984	-56.85	-39.5	-17.35
H	5774.976	-52.62	-39.5	-13.12
H	7699.968	-50.55	-39.5	-11.05
V	3849.984	-56.98	-39.5	-17.48
V	5774.976	-52.92	-39.5	-13.42
V	7699.968	-50.91	-39.5	-11.41

Highest Channel:

Polarization	Frequency (MHz)	Measured Power (dBm)	Power Limit (dBm)	Margin (dBm)
H	3856.896	-57.21	-39.5	-17.71
H	5785.344	-52.06	-39.5	-12.56
H	7713.792	-51.66	-39.5	-12.16
V	3856.896	-56.89	-39.5	-17.39
V	5785.344	-53.54	-39.5	-14.04
V	7713.792	-51.3	-39.5	-11.8



Unless otherwise agreed in writing, this document is issued by the Company subject to its General Conditions of Service printed overleaf, available on request or accessible at <http://www.sgs.com/en/Terms-and-Conditions.aspx> and, for electronic format documents, subject to Terms and Conditions for Electronic Documents at <http://www.sgs.com/en/Terms-and-Conditions/Terms-e-Documents.aspx>. Attention is drawn to the limitation of liability, indemnification and jurisdiction issues defined therein. Any holder of this document is advised that information contained hereon reflects the Company's findings at the time of its intervention only and within the limits of Client's instructions, if any. The Company's sole responsibility is to its Client and this document does not exonerate parties to a transaction from exercising all their rights and obligations under the transaction documents. This document cannot be reproduced except in full, without prior written approval of the Company. Any unauthorized alteration, forgery or falsification of the content or appearance of this document is unlawful and offenders may be prosecuted to the fullest extent of the law. Unless otherwise stated the results shown in this test report refer only to the sample(s) tested and such sample(s) are retained for 30 days only.
 Attention: To check the authenticity of testing /inspection report & certificate, please contact us at telephone: (86-755) 8307 1443, or email: CN.Doccheck@sgs.com

7 Photographs

Please refer to setup photos.

7.1 EUT Constructional Details (EUT Photos)

Please refer to external and internal photos for details.

- End of the Report -

