



FCC TEST REPORT

FCC ID:2ATOQ-R20

Product	:	Robotic Vacuum Cleaner
Model Name	:	R20,R21, R22, R23, R24, R25, R26, R27, R28, R29, KK7, KK71
Brand	:	N/A
Report No.	:	PTC20112006102E-FC01
Prepared for		
Dongguan Xinsu Technology Co., Ltd.		
Room 106, Chuangtou Building, No.8 Industrial South Road, Songshan Lake High-tech Industrial Development Zone, Dongguan		
Prepared by		
Precise Testing & Certification Co., Ltd		
Building 1, No. 6, Tongxin Road, Dongcheng Street, Dongguan, Guangdong, China		



1 TEST RESULT CERTIFICATION

Applicant's name : Dongguan Xinsu Technology Co., Ltd.
Address : Room 106, Chuangtou Building, No.8 Industrial South Road, Songshan Lake High-tech Industrial Development Zone, Dongguan
Manufacture's name : Dongguan Xinsu Technology Co., Ltd. Dalingshan Branch
Address : Room 103, building 5, No. 136, Yongjun Road, Dalingshan Town, Dongguan City, Guangdong Province
Product name : Robotic Vacuum Cleaner
Model name : R20, R21, R22, R23, R24, R25, R26, R27, R28, R29, KK7, KK71
Standards : FCC CFR47 Part 15 Section 15.247
Test procedure : ANSI C63.10:2013
Test Date : December 24, 2020 to January 08, 2021
Date of Issue : January 08, 2021
Test Result : Pass

This device described above has been tested by PTC, and the test results show that the equipment under test (EUT) is in compliance with the FCC requirements. And it is applicable only to the tested sample identified in the report.

This report shall not be reproduced except in full, without the written approval of PTC, this document may be altered or revised by PTC, personal only, and shall be noted in the revision of the document.

Test Engineer:

A handwritten signature in black ink that reads "Leo Yang".

Leo Yang / Engineer

Technical Manager:

A handwritten signature in black ink that appears to read "Chris Du".

Chris Du / Manager



Contents

	Page
1 TEST RESULT CERTIFICATION.....	2
2 TEST SUMMARY.....	5
3 GENERAL INFORMATION.....	6
3.1 GENERAL DESCRIPTION OF E.U.T.....	6
3.2 CHANNEL LIST.....	7
3.3 TEST SITE.....	10
4 EQUIPMENT DURING TEST.....	11
4.1 EQUIPMENTS LIST.....	11
4.2 MEASUREMENT UNCERTAINTY.....	13
4.3 DESCRIPTION OF SUPPORT UNITS.....	13
5 CONDUCTED EMISSION.....	14
5.1 E.U.T. OPERATION.....	14
5.2 EUT SETUP.....	14
5.3 TEST SET-UP (BLOCK DIAGRAM OF CONFIGURATION).....	15
5.4 MEASUREMENT PROCEDURE.....	15
5.5 CONDUCTED EMISSION LIMIT.....	15
5.6 MEASUREMENT DESCRIPTION.....	15
5.7 CONDUCTED EMISSION TEST RESULT.....	15
6 RADIATED SPURIOUS EMISSIONS.....	18
6.1 EUT OPERATION.....	18
6.2 TEST SETUP.....	19
6.3 SPECTRUM ANALYZER SETUP.....	20
6.4 TEST PROCEDURE.....	21
6.5 SUMMARY OF TEST RESULTS.....	22
7 CONDUCTED SPURIOUS EMISSION.....	29
7.1 TEST PROCEDURE.....	29
7.2 TEST RESULT.....	29
8 BAND EDGE MEASUREMENT.....	32



8.1 TEST PROCEDURE.....	32
8.2 TEST RESULT.....	33
9 6DB BANDWIDTH MEASUREMENT.....	37
9.1 TEST PROCEDURE.....	37
9.2 TEST RESULT.....	37
10 MAXIMUM PEAK OUTPUT POWER.....	44
10.1 TEST PROCEDURE.....	44
10.2 TEST RESULT.....	44
11 POWER SPECTRAL DENSITY.....	45
11.1 TEST PROCEDURE.....	45
11.2 TEST RESULT.....	45
12 ANTENNA APPLICATION.....	52
12.1 ANTENNA REQUIREMENT.....	52
12.2 RESULT.....	52
13 TEST SETUP.....	53
14 EUT PHOTOS.....	55



2 Test Summary

Test Items	Test Requirement	Result
Conduct Emission	15.207	PASS
Radiated Spurious Emissions	15.205(a) 15.209 15.247(d)	PASS
Conducted Spurious Emission	15.247(d)	PASS
Band edge	15.247(d) 15.205(a)	PASS
6dB Bandwidth	15.247(a)(2)	PASS
Maximum Peak Output Power	15.247(b)(3)	PASS
Power Spectral Density	15.247(e)	PASS
Antenna Requirement	15.203	PASS
Remark: N/A: Not Applicable		



3 General Information

3.1 General Description of E.U.T.

Product Name	:	Robotic Vacuum Cleaner
Model Name	:	R20,R21, R22, R23, R24, R25, R26, R27, R28, R29, KK7, KK71 Note:Product appearance colors are different, others are the same
Specification	:	802.11b/g/n HT20/HT40
Operating frequency	:	2412-2462MHz for 802.11b; 2412-2462MHz for 802.11g; 2412-2462MHz for 802.11n(HT20); 2422-2452MHz for 802.11n(HT40) ;
Number of Channel	:	11 Channels for 802.11b; 11 Channels for 802.11g; 11 Channels for 802.11n(HT20); 7 Channels for 802.11n(HT40);
Antenna installation	:	FIPA antenna
Antenna Gain	:	3Bi
Type of Modulation	:	DSSS with DBPSK/DQPSK/CCK for 802.11b; OFDM with BPSK/QPSK/16QAM/64QAM for 802.11g/n;
Hardware Version	:	N/A
Software Version	:	N/A
Power supply	:	Model: GQ12-190060-AU AC 100-240V DC19V 600MA(battery:14.8V 3200mA) Model: KA1201A-1900600US AC 100-240V DC19V 600MA(battery:14.8V 3200mA)



3.2 Channel List

The EUT has been tested under its typical operating condition.

The EUT configuration for testing is installed on RF field strength measurement to meet the Commissions requirement and operating in a manner which intends to maximize its emission characteristics in a continuous normal application.

The Transmitter was operated in the normal operating mode. The TX frequency was fixed which was for the purpose of the measurements.

Test of channel included the lowest and middle and highest frequency to perform the test, then record on this report.

Those data rates (802.11b: 1 Mbps; 802.11g: 6 Mbps; 802.11n (HT20): MCS0;) were used for all test.

Pre-defined engineering program for regulatory testing used to control the EUT for staying in continuous transmitting and receiving mode is programmed.

Frequency and Channel list for 802.11 b/g/n (HT20/HT40)

Channel	Frequency (MHz)	Channel	Frequency (MHz)	Channel	Frequency (MHz)
1	2412	5	2432	9	2452
2	2417	6	2437	10	2457
3	2422	7	2442	11	2462
4	2427	8	2447		

Test Frequency and Channel for 802.11 b/g/n (HT20/HT40):

Lowest Frequency		Middle Frequency		Highest Frequency	
Channel	Frequency (MHz)	Channel	Frequency (MHz)	Channel	Frequency (MHz)
1	2412	6	2437	11	2462
3	2422	6	2437	9	2452



The maximum duty cycle as following table:

Test Mode	Duty Cycle(%)
802.11b	100%
802.11g	100%
802.11n(HT20)	100%
802.11n(HT40)	100%

Test Plots:

802.11b



802.11g

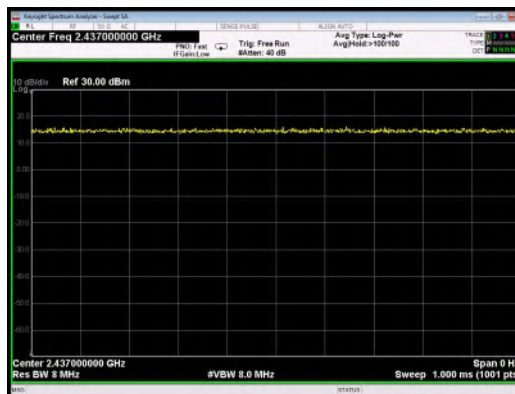



802.11n(HT20)

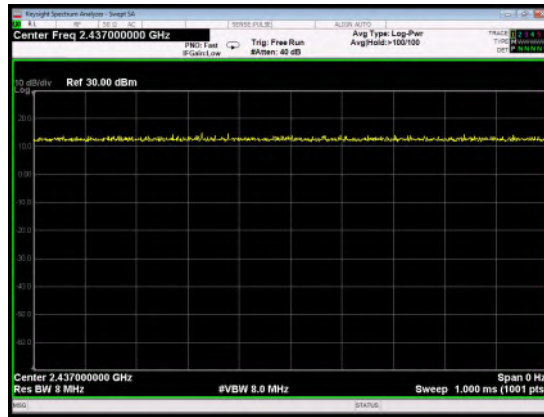

802.11n(HT40)

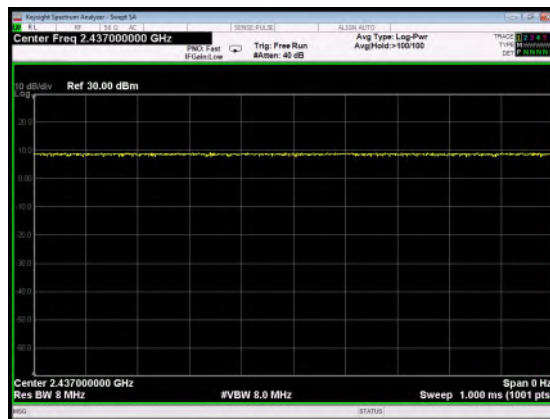



Report No.: PTC20112006102E-FC01

3.3 Test Site

Precise Testing & Certification Co., Ltd

Address: Building 1, No. 6, Tongxin Road, Dongcheng Street, Dongguan, Guangdong, China

FCC Registration Number: 790290

A2LA Certificate No.: 4408.01

IC Registration Number: 12191A-1



4 Equipment During Test

4.1 Equipments List

RF Conducted Test

Name of Equipment	Manufacturer	Model	Serial No.	Characteristics	Calibration Due
MXG Signal Analyzer	Agilent	N9020A	SER MY5111038	10Hz-30GHz	Aug. 21, 2021
Coaxial Cable	CDS	79254	46107086	10Hz-30GHz	Aug. 21, 2021
Power Meter	Anritsu	ML2495A	0949003	300MHz-40GHz	Aug. 21, 2021
Power Sensor	Anritsu	MA2411B	0917017	300MHz-40GHz	Aug. 21, 2021

Remark: The temporary antenna connector is soldered on the PCB board in order to perform conducted tests and this temporary antenna connector is listed in the equipment list.

Name of Equipment	Manufacturer	Model	Serial No.	Characteristics	Calibration Due
EMI Test Receiver	Rohde&Schwarz	ESCI	101417	9KHz-3GHz	Aug. 21, 2021
Loop Antenna	Schwarzbeck	FMZB 1519	012	9 KHz -30MHz	Aug. 21, 2021
Bilog Antenna	SCHWARZBECK	VULB9160	9160-3355	25MHz-2GHz	Aug. 21, 2021
Preamplifier (low frequency)	SCHWARZBECK	BBV 9475	9745-0013	1MHz-1GHz	Aug. 21, 2021
Cable	Schwarzbeck	PLF-100	549489	9KHz-3GHz	Aug. 21, 2021
Spectrum Analyzer	Agilent	E4407B	MY45109572	9KHz-40GHz	Aug. 21, 2021
Horn Antenna	SCHWARZBECK	9120D	9120D-1246	1GHz-18GHz	Aug. 21, 2021
Power Amplifier	LUNAR EM	LNA1G18-40	J10100000081	1GHz-26.5GHz	Aug. 21, 2021
Horn Antenna	SCHWARZBECK	BBHA 9170	9170-181	14GHz-40GHz	Aug. 21, 2021
Amplifier	SCHWARZBECK	BBV 9721	9721-205	18GHz-40GHz	Aug. 21, 2021



Cable	H+S	CBL-26	N/A	1GHz-26.5GHz	Aug. 21, 2021
RF Cable	R&S	R204	R21X	1GHz-40GHz	Aug. 21, 2021

Conducted Emissions

Name of Equipment	Manufacturer	Model	Serial No.	Characteristics	Calibration Due
EMI Test Receiver	Rohde&Schwarz	ESCI	101417	9KHz-3GHz	Aug. 21, 2021
Artificial Mains Network	Rohde&Schwarz	ENV216	102453	9KHz-300MHz	Aug. 21, 2021
Artificial Mains Network	Rohde&Schwarz	ENV216	101342	9KHz-300MHz	Aug. 21, 2021



4.2 Measurement Uncertainty

Parameter	Uncertainty
RF output power, conducted	±1.0dB
Power Spectral Density, conducted	±2.2dB
Radio Frequency	± 1 x 10 ⁻⁶
Bandwidth	± 1.5 x 10 ⁻⁶
Time	±2%
Duty Cycle	±2%
Temperature	±1°C
Humidity	±5%
DC and low frequency voltages	±3%
Conducted Emissions (150kHz~30MHz)	±3.64dB
Radiated Emission(30MHz~1GHz)	±5.03dB
Radiated Emission(1GHz~25GHz)	±4.74dB

4.3 Description of Support Units

Equipment	Model No.KA1201A-1900600US	Series No.
Adapter	Input:100-240V~, 50-60Hz	N/A

5 Conducted Emission

Test Requirement: : FCC CFR 47 Part 15 Section 15.207
Test Method : ANSI C63.10: 2013
Test Result : PASS
Frequency Range : 150kHz to 30MHz
Class/Severity : Class B

5.1 E.U.T. Operation

Operating Environment :

Temperature : 23.9 °C
Humidity : 51.4 % RH
Atmospheric Pressure : 101.21kPa

5.2 EUT Setup

The conducted emission tests were performed using the setup accordance with the ANSI C63.10:2013.

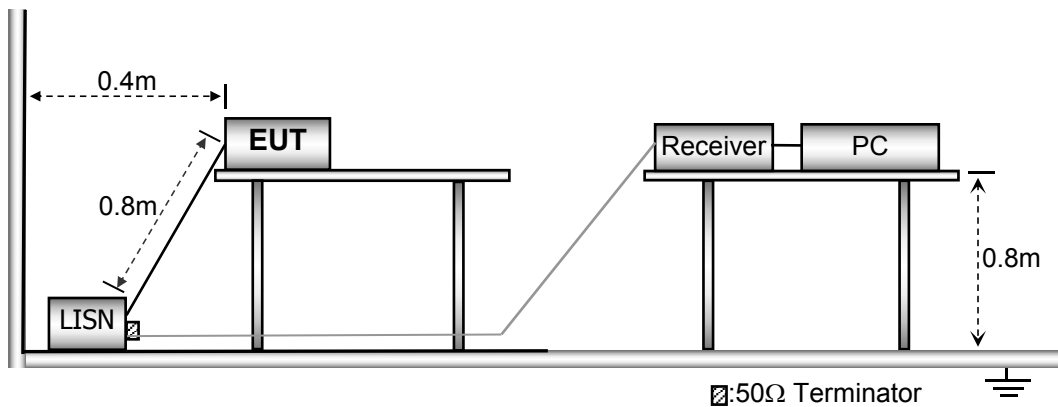



5.3 Test SET-UP (Block Diagram of Configuration)

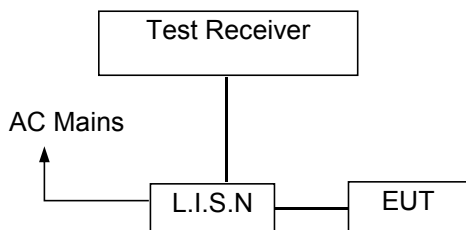

5.4 Measurement Procedure

1. The EUT was placed on a table, which is 0.8m above ground plane.
2. Maximum procedure was performed on the six highest emissions to ensure EUT compliance.
3. Repeat above procedures until all frequency measured was complete.

5.5 Conducted Emission Limit

Conducted Emission

Frequency(MHz)	Quasi-peak	Average
0.15-0.5	66-56	56-46
0.5-5.0	56	46
5.0-30.0	60	50

Note:

1. The lower limit shall apply at the transition frequencies
2. The limit decreases in line with the logarithm of the frequency in the range of 0.15 to 0.50MHz.

5.6 Measurement Description

The maximised peak emissions from the EUT was scanned and measured for both the Live and Neutral Lines. Quasi-peak & average measurements were performed if peak emissions were within 6dB of the average limit line.

5.7 Conducted Emission Test Result

Pass.

2 adapters and all modulation modes of 120V/240V have been tested, the worst mode KA1201A-1900600US adapter and 120V (TX 802.11b low channel) data are recorded on the following page, other modulation methods do not exceed the limit.

Please refer to the following pages.



Line- AC 120V/60Hz

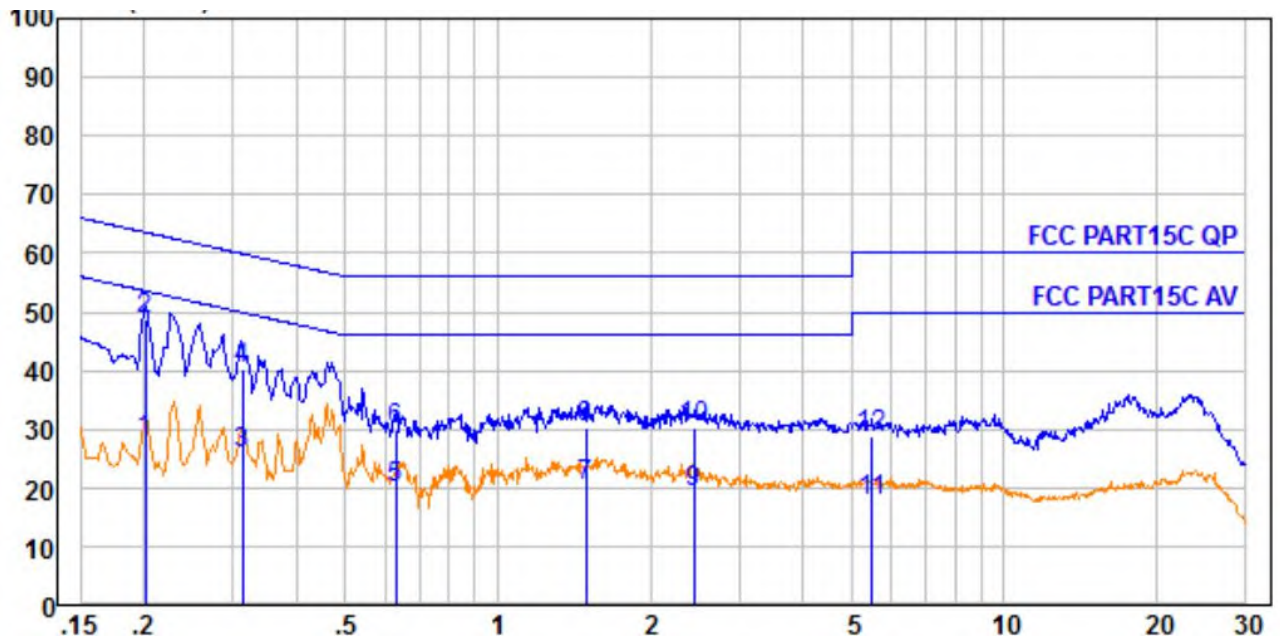

No.	Freq MHz	Cable Loss dB	AMN Factor dB	Receiver Reading dBµV	Emission Level dBµV	Limit dBµV	Over Limit dB	Remark
1.	0.202	0.28	9.59	18.18	28.05	53.54	-25.49	Average
2.	0.202	0.28	9.59	38.80	48.67	63.54	-14.87	QP
3.	0.313	0.38	9.60	15.83	25.81	49.88	-24.07	Average
4.	0.313	0.38	9.60	30.23	40.21	59.88	-19.67	QP
5.	0.630	0.44	9.61	10.01	20.06	46.00	-25.94	Average
6.	0.630	0.44	9.61	19.87	29.92	56.00	-26.08	QP
7.	1.495	0.47	9.61	10.36	20.44	46.00	-25.56	Average
8.	1.495	0.47	9.61	20.21	30.29	56.00	-25.71	QP
9.	2.435	0.47	9.62	9.20	19.29	46.00	-26.71	Average
10.	2.435	0.47	9.62	20.31	30.40	56.00	-25.60	QP
11.	5.476	0.51	9.69	7.56	17.76	50.00	-32.24	Average
12.	5.476	0.51	9.69	18.61	28.81	60.00	-31.19	QP



Neutral-AC 120V/60Hz

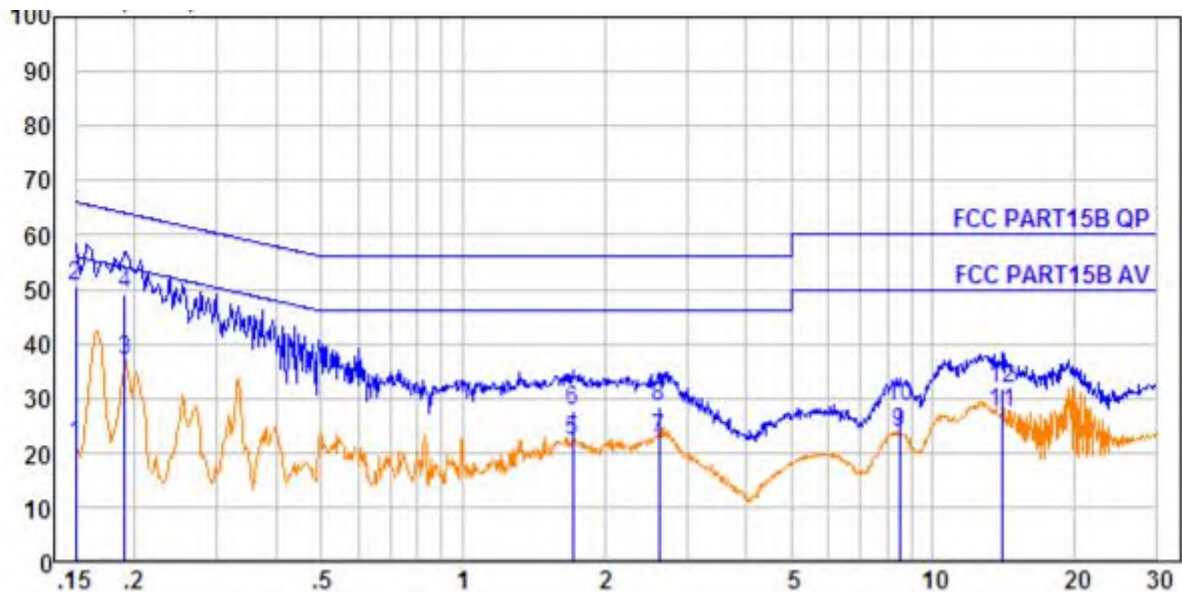

No.	Freq MHz	Cable Loss dB	AMN Factor dB	Receiver Reading dBμV	Emission Level dBμV	Limit dBμV	Over Limit dB	Remark
1.	0.202	0.28	9.59	18.18	28.05	53.54	-25.49	Average
2.	0.202	0.28	9.59	38.80	48.67	63.54	-14.87	QP
3.	0.313	0.38	9.60	15.83	25.81	49.88	-24.07	Average
4.	0.313	0.38	9.60	30.23	40.21	59.88	-19.67	QP
5.	0.630	0.44	9.61	10.01	20.06	46.00	-25.94	Average
6.	0.630	0.44	9.61	19.87	29.92	56.00	-26.08	QP
7.	1.495	0.47	9.61	10.36	20.44	46.00	-25.56	Average
8.	1.495	0.47	9.61	20.21	30.29	56.00	-25.71	QP
9.	2.435	0.47	9.62	9.20	19.29	46.00	-26.71	Average
10.	2.435	0.47	9.62	20.31	30.40	56.00	-25.60	QP
11.	5.476	0.51	9.69	7.56	17.76	50.00	-32.24	Average
12.	5.476	0.51	9.69	18.61	28.81	60.00	-31.19	QP



6 Radiated Spurious Emissions

Test Requirement : FCC CFR47 Part 15 Section 15.209 & 15.247
 Test Method : ANSI C63.10:2013
 Test Result : PASS
 Measurement Distance : 3m
 Limit : See the follow table

Frequency (MHz)	Field Strength		Field Strength Limit at 3m Measurement Dist	
	uV/m	Distance (m)	uV/m	dBuV/m
0.009 ~ 0.490	$2400/F(\text{kHz})$	300	$10000 * 2400/F(\text{kHz})$	$20\log^{(2400/F(\text{kHz}))} + 80$
0.490 ~ 1.705	$24000/F(\text{kHz})$	30	$100 * 24000/F(\text{kHz})$	$20\log^{(24000/F(\text{kHz}))} + 40$
1.705 ~ 30	30	30	$100 * 30$	$20\log^{(30)} + 40$
30 ~ 88	100	3	100	$20\log^{(100)}$
88 ~ 216	150	3	150	$20\log^{(150)}$
216 ~ 960	200	3	200	$20\log^{(200)}$
Above 960	500	3	500	$20\log^{(500)}$

6.1 EUT Operation

Operating Environment :

Temperature: : 24.5 °C
 Humidity: : 52 % RH
 Atmospheric Pressure: : 101.3kPa
 Test Voltage : AC 120V/60HZ

6.2 Test Setup

The radiated emission tests were performed in the 3m Semi- Anechoic Chamber test site

The test setup for emission measurement below 30MHz.

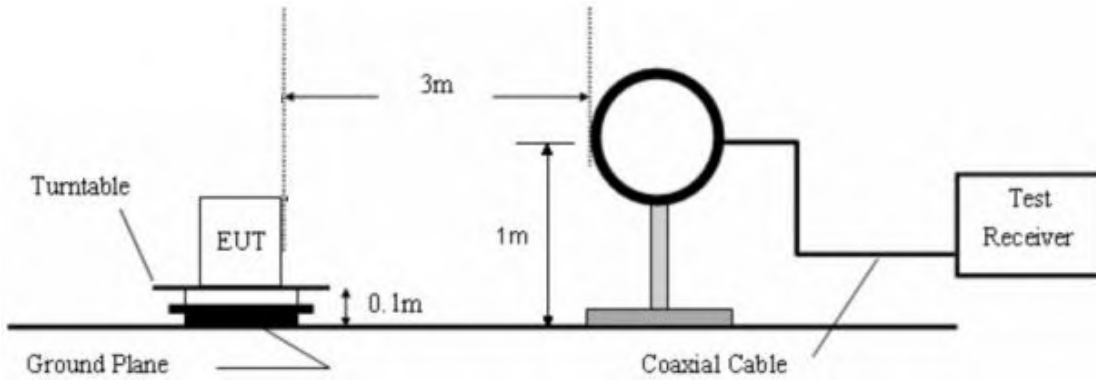

The test setup for emission measurement from 30 MHz to 1 GHz.

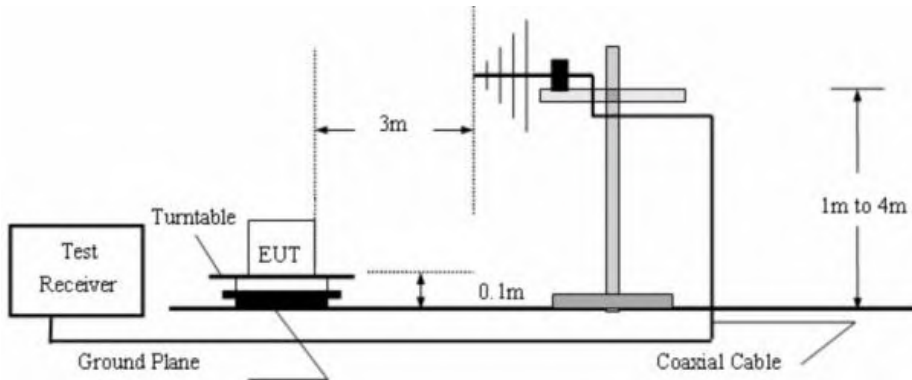

The test setup for emission measurement above 1 GHz.

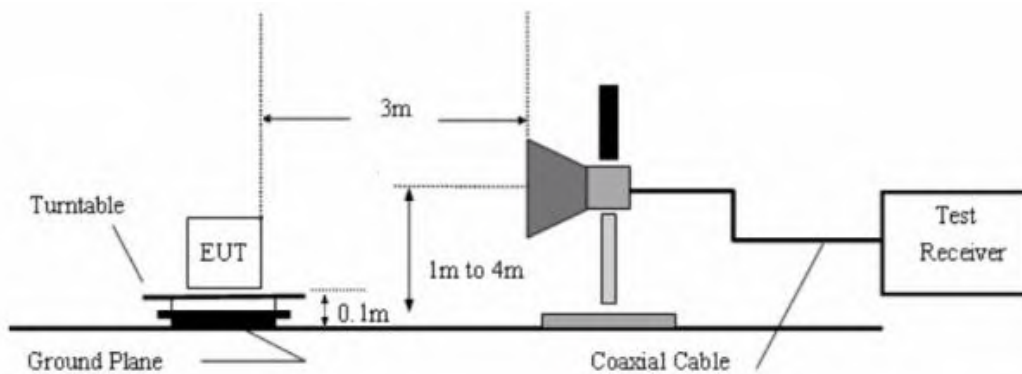



6.3 Spectrum Analyzer Setup

	Frequency	Detector	RBW	VBW	Remark
Receiver Setup	Below 30MHz	--	10kHz	10kHz	--
	30MHz ~ 1GHz	Quasi-peak	120kHz	300kHz	Quasi-peak Value
	Above 1GHz	Peak	1MHz	3MHz	Peak Value
		RMS	1MHz	3MHz	Average Value



6.4 Test Procedure

1. Below 1000MHz, The EUT was placed on a turn table which is 0.8m above ground plane, And above 1000MHz, The EUT was placed on a styrofoam table which is 1.5m above ground plane.
2. The turntable shall be rotated for 360 degrees to determine the position of maximum emission level.
3. EUT is set 3m away from the receiving antenna, which is moved from 1m to 4m to find out the maximum emissions. The spectrum was investigated from the lowest radio frequency signal generated in the device, without going below 9 kHz, up to the tenth harmonic of the highest fundamental frequency or to 40 GHz, whichever is lower.
4. Maximum procedure was performed on the six highest emissions to ensure EUT compliance.
5. And also, each emission was to be maximized by changing the polarization of receiving antenna both horizontal and vertical.
6. Repeat above procedures until the measurements for all frequencies are complete.
7. The radiation measurements are tested under 3-axes(X,Y,Z) position(X denotes lying on the table, Y denotes side stand and Z denotes vertical stand), After pre-test, It was found that the worse radiation emission was get at the X position. So the data shown was the X position only.
8. The test above 1GHz must be use the fully anechoic room, and the test below 1GHz use the half anechoic room



6.5 Summary of Test Results

Test Frequency: 9KHz-30MHz

Freq. (MHz)	Ant.Pol. H/V	Emission Level (dBuV/m)	Limit 3m (dBuV/m)	Over (dB)
--	--	--	--	>20

Note:

The amplitude of spurious emission that is attenuated by more than 20dB below the permissible limit has no need to be reported.

Distance extrapolation factor = $40\log(\text{Specific distance} / \text{test distance})$ (dB);

Limit line = Specific limits (dBuV) + distance extrapolation factor.

Test Frequency: 30MHz ~ 1GHz

2 adapters and all modulation modes of 120V/240V have been tested, the worst mode KA1201A-1900600US adapter and 120V (TX 802.11b low channel) data are recorded on the following page, other modulation methods do not exceed the limit.

Please refer to the following test plots:



Antenna Polarization: Horizontal

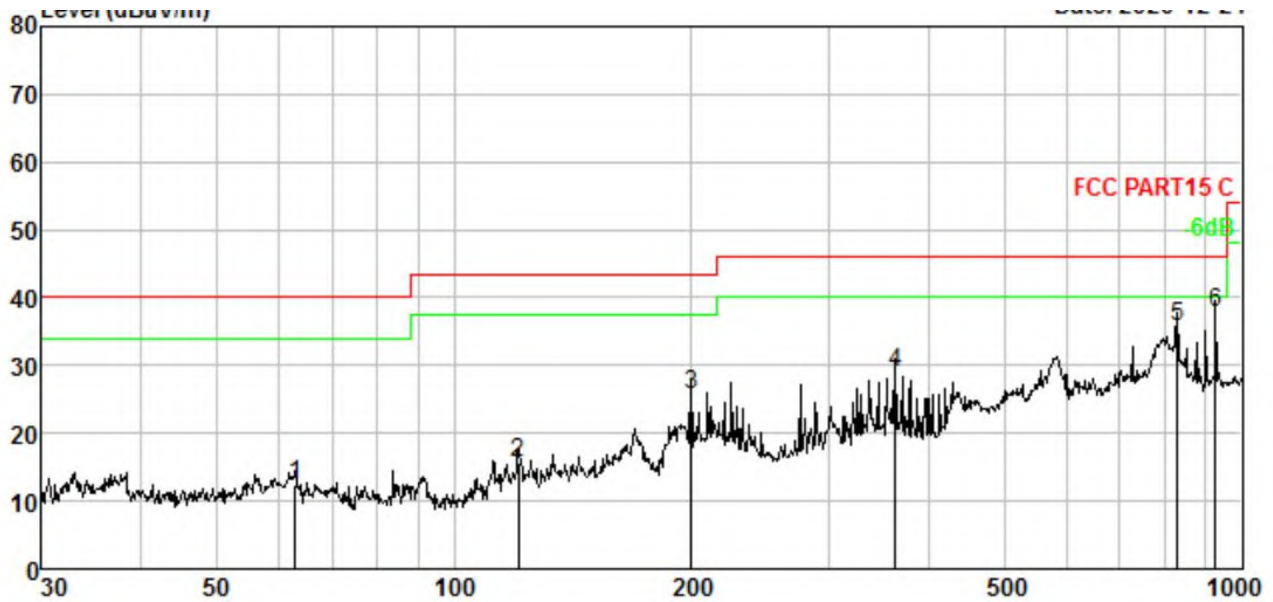

No.	Freq MHz	Cable Loss dB	ANT Factor dB/m	Receiver Reading dBuV	Preamp Factor dB	Emission Level dBuV/m	Limit dBuV/m	Over Limit dB	Remark
1.	62.871	2.47	11.29	28.61	29.94	12.43	40.00	-27.57	QP
2.	120.699	3.60	12.05	30.13	30.00	15.78	43.50	-27.72	QP
3.	199.986	4.46	11.00	40.26	30.04	25.68	43.50	-17.82	QP
4.	362.985	5.49	14.51	39.54	30.57	28.97	46.00	-17.03	QP
5.	827.493	6.91	21.51	38.37	31.13	35.66	46.00	-10.34	QP
6.	925.756	7.10	22.20	39.42	31.04	37.68	46.00	-8.32	QP

Remark: Emission Level = Reading + Cable Loss + ANT Factor - AMP Factor



Antenna Polarization: Vertical

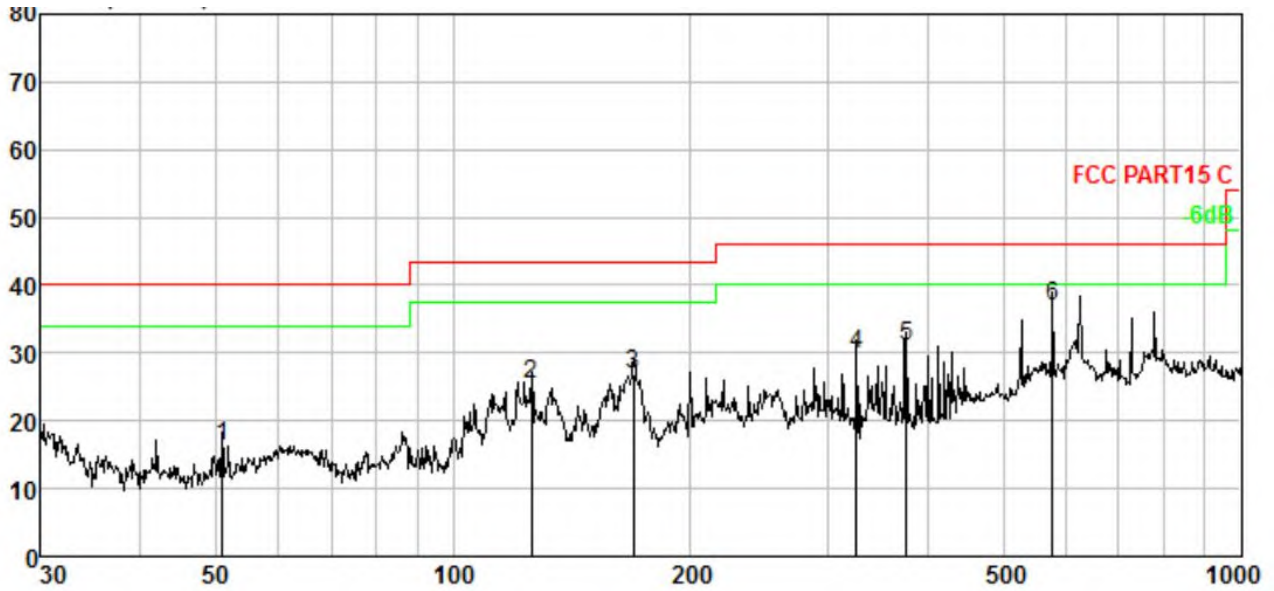

No.	Freq MHz	Cable Loss dB	ANT Factor dB/m	Receiver Reading dBuV	Preamp Factor dB	Emission Level dBuV/m	Limit dBuV/m	Over Limit dB	Remark
1.	50.942	2.11	12.10	31.97	29.92	16.26	40.00	-23.74	QP
2.	125.886	3.67	12.40	39.24	30.01	25.30	43.50	-18.20	QP
3.	169.599	4.18	13.31	39.39	30.03	26.85	43.50	-16.65	QP
4.	325.596	5.30	13.84	41.18	30.43	29.89	46.00	-16.11	QP
5.	375.939	5.55	14.61	41.50	30.62	31.04	46.00	-14.96	QP
6.	576.644	6.28	18.61	42.99	30.99	36.89	46.00	-9.11	QP

Remark: Emission Level = Reading + Cable Loss + ANT Factor - AMP Factor



Test Frequency: From 1GHz to 18GHz

Worst case 802.11b

Test Mode: 2412					Test channel: Lowest			
Peak Value								
Frequency (MHz)	Read Level (dBuV)	Antenna Factor (dB/m)	Cable Loss (dB)	Preamp Factor (dB)	Level (dBuV/m)	Limit (dBuV/m)	Over Limit (dB)	Pol.
4824.00	41.00	32.29	4.10	28.45	48.94	74.00	-25.06	V
7236.00	34.66	35.99	6.22	27.83	49.04	74.00	-24.96	V
9648.00	33.03	38.11	7.83	25.10	53.87	74.00	-20.13	V
4824.00	39.56	32.29	4.10	28.45	47.50	74.00	-26.50	H
7236.00	34.36	35.99	6.22	27.83	48.74	74.00	-25.26	H
9648.00	32.59	38.11	7.83	25.10	53.43	74.00	-20.57	H
Average Value								
Frequency (MHz)	Read Level (dBuV)	Antenna Factor (dB/m)	Cable Loss (dB)	Preamp Factor (dB)	Level (dBuV/m)	Limit (dBuV/m)	Over Limit (dB)	Pol.
4824.00	30.03	32.29	4.10	28.45	37.97	54.00	-16.03	V
7236.00	23.52	35.99	6.22	27.83	37.90	54.00	-16.10	V
9648.00	23.37	38.11	7.83	25.10	44.21	54.00	-9.79	V
4824.00	29.06	32.29	4.10	28.45	37.00	54.00	-17.00	H
7236.00	22.93	35.99	6.22	27.83	37.31	54.00	-16.69	H
9648.00	22.32	38.11	7.83	25.10	43.16	54.00	-10.84	H



Worst case 802.11b

Test Mode: 2437					Test channel: Middle			
Peak Value								
Frequency (MHz)	Read Level (dBuV)	Antenna Factor (dB/m)	Cable Loss (dB)	Preamp Factor (dB)	Level (dBuV/m)	Limit (dBuV/m)	Over Limit (dB)	Pol.
4874.00	39.93	32.35	4.12	28.44	47.96	74.00	-26.04	V
7311.00	34.66	36.08	6.30	27.74	49.30	74.00	-24.70	V
9748.00	34.00	38.25	7.91	24.65	55.51	74.00	-18.49	V
4874.00	40.32	32.35	4.12	28.44	48.35	74.00	-25.65	H
7311.00	33.25	36.08	6.30	27.74	47.89	74.00	-26.11	H
9748.00	33.87	38.25	7.91	24.65	55.38	74.00	-18.62	H
Average Value								
Frequency (MHz)	Read Level (dBuV)	Antenna Factor (dB/m)	Cable Loss (dB)	Preamp Factor (dB)	Level (dBuV/m)	Limit (dBuV/m)	Over Limit (dB)	Pol.
4874.00	30.74	32.35	4.12	28.44	38.77	54.00	-15.23	V
7311.00	22.96	36.08	6.30	27.74	37.60	54.00	-16.40	V
9748.00	23.24	38.25	7.91	24.65	44.75	54.00	-9.25	V
4874.00	30.40	32.35	4.12	28.44	38.43	54.00	-15.57	H
7311.00	22.33	36.08	6.30	27.74	36.97	54.00	-17.03	H
9748.00	23.57	38.25	7.91	24.65	45.08	54.00	-8.92	H



Worst case 802.11b

Test Mode: 2462					Test channel: High			
Peak Value								
Frequency (MHz)	Read Level (dBuV)	Antenna Factor (dB/m)	Cable Loss (dB)	Preamp Factor (dB)	Level (dBuV/m)	Limit (dBuV/m)	Over Limit (dB)	Pol.
4924.00	45.89	32.41	4.14	28.42	54.02	74.00	-19.98	V
7386.00	35.60	36.15	6.36	27.68	50.43	74.00	-23.57	V
9848.00	37.48	38.35	7.97	24.33	59.47	74.00	-14.53	V
4924.00	45.03	32.41	4.14	28.42	53.16	74.00	-20.84	H
7386.00	34.42	36.15	6.36	27.68	49.25	74.00	-24.75	H
9848.00	33.62	38.35	7.97	24.33	55.61	74.00	-18.39	H
Average Value								
Frequency (MHz)	Read Level (dBuV)	Antenna Factor (dB/m)	Cable Loss (dB)	Preamp Factor (dB)	Level (dBuV/m)	Limit (dBuV/m)	Over Limit (dB)	Pol.
4924.00	36.72	32.41	4.14	28.42	44.85	54.00	-9.15	V
7386.00	25.49	36.15	6.36	27.68	40.32	54.00	-13.68	V
9848.00	25.97	38.35	7.97	24.33	47.96	54.00	-6.04	V
4924.00	35.35	32.41	4.14	28.42	43.48	54.00	-10.52	H
7386.00	23.79	36.15	6.36	27.68	38.62	54.00	-15.38	H
9848.00	22.86	38.35	7.97	24.33	44.85	54.00	-9.15	H

Note:

1. The testing has been conformed to $10 \times 2462\text{MHz} = 24620\text{MHz}$.
2. All other emissions more than 30dB below the limit.
3. Factor = Antenna Factor + Cable Loss – Pre-amplifier.
Emission Level = Reading + Factor
Margin=Emission Level-Limit
4. X-Axis, Y-Axis and Z-Axis were investigated. The results above show only the worst case.

Spurious Emission in Restricted Band 2310-2390MHz and 2483.5-2500MHz
2.4G WiFi (802.11b/g/n)mode have been tested, and the worst result(802.11g) was report as below



Test Mode: 802.11g Low Channel 2412MHz

Test Mode: 802.11g Low Channel 2412MHz									
Frequency (MHz)	Read Level (dBuV)	Antenna Factor (dB/m)	Cable Loss (dB)	Preamp Factor (dB)	Level (dBuV/m)	Limit (dBuV/m)	Over (dB)	Polarity H/V	Test Value
2390.00	52.99	27.39	2.77	34.01	49.14	74.00	-24.86	H	Peak
2400.00	62.45	27.42	2.78	34.01	58.64	74.00	-15.36	H	
2390.00	54.76	27.39	2.77	34.01	50.91	74.00	-23.09	V	
2400.00	64.61	27.42	2.78	34.01	60.80	74.00	-13.20	V	
2390.00	39.36	27.39	2.77	34.01	35.51	54.00	-18.49	H	Average
2400.00	47.80	27.42	2.78	34.01	43.99	54.00	-10.01	H	
2390.00	41.29	27.39	2.77	34.01	37.44	54.00	-16.56	V	
2400.00	49.03	27.42	2.78	34.01	45.22	54.00	-8.78	V	

Test Mode: 802.11g High Channel 2462MHz

Test Mode: 802.11g High Channel 2462MHz									
Frequency (MHz)	Read Level (dBuV)	Antenna Factor (dB/m)	Cable Loss (dB)	Preamp Factor (dB)	Level (dBuV/m)	Limit (dBuV/m)	Over (dB)	Polarity H/V	Test Value
2483.50	54.22	27.70	2.84	34.03	50.73	74.00	-23.27	H	Peak
2500.00	49.62	27.75	2.86	34.03	46.20	74.00	-27.80	H	
2483.50	56.75	27.70	2.84	34.03	53.26	74.00	-20.74	V	
2500.00	52.38	27.75	2.86	34.03	48.96	74.00	-25.04	V	
2483.50	39.93	27.70	2.84	34.03	36.44	54.00	-17.56	H	Average
2500.00	35.78	27.75	2.86	34.03	32.36	54.00	-21.64	H	
2483.50	42.00	27.70	2.84	34.03	38.51	54.00	-15.49	V	
2500.00	37.71	27.75	2.86	34.03	34.29	54.00	-19.71	V	

Test Frequency: From 18GHz to 25GHz

The measurements were more than 20dB below the limit and not reported.



7 Conducted Spurious Emission

Test Requirement	:	FCC CFR47 Part 15 Section 15.247
Test Method	:	ANSI C63.10:2013
Test Limit	:	Regulation 15.247 (d), In any 100 kHz bandwidth outside the frequency band in which the spread spectrum or digitally modulated intentional radiator is operating, the radio frequency power that is produced by the intentional radiator shall be at least 20 dB below that in the 100 kHz bandwidth within the band that contains the highest level of the desired power, based on either an RF conducted or a radiated measurement, provided the transmitter demonstrates compliance with the peak conducted power limits. If the transmitter complies with the conducted power limits based on the use of RMS averaging over a time interval, as permitted under paragraph (b)(3) of this section, the attenuation required under this paragraph shall be 30 dB instead of 20 dB. Attenuation below the general limits specified in §15.209(a) is not required. In addition, radiated emissions which fall in the restricted bands, as defined in §15.205(a), must also comply with the radiated emission limits specified in §15.209(a) (see §15.205(c)).

7.1 Test Procedure

1. Remove the antenna from the EUT and then connect a low RF cable from the antenna port to the spectrum;
2. Set the spectrum analyzer: RBW = 100kHz, VBW = 300kHz, Sweep = auto
Detector function = peak, Trace = max hold

7.2 Test Result



802.11 b
Low Channel Worstcase mode

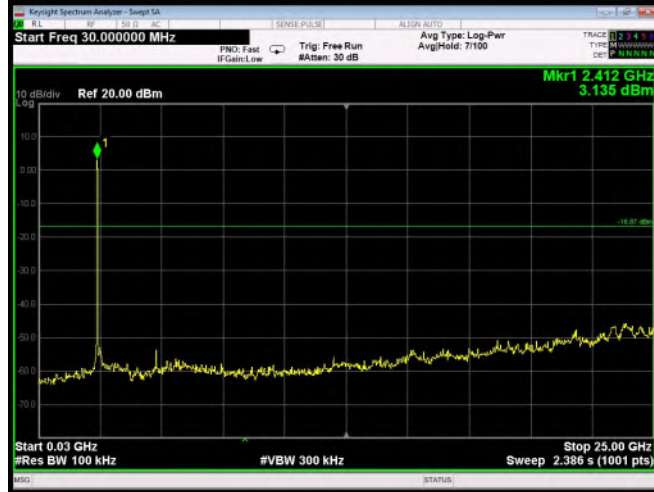

802.11 g
Low Channel Worstcase mode

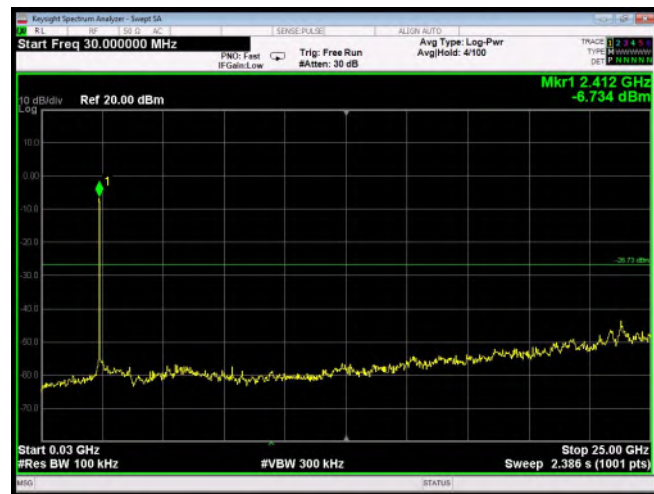

802.11 HT20
Low Channel Worstcase mode



802.11 HT40

Low Channel Worstcase mode





8 Band Edge Measurement

Test Requirement	:	Section 15.247(d) In addition, radiated emissions which fall in the restricted bands, as defined in Section 15.205(a), must also comply with the radiated emission limits specified in Section 15.209(a) (see Section 15.205(c)).
Test Method	:	ANSI C63.10:2013
Test Limit	:	Regulation 15.247 (d), In any 100 kHz bandwidth outside the frequency band in which the spread spectrum or digitally modulated intentional radiator is operating, the radio frequency power that is produced by the intentional radiator shall be at least 20 dB below that in the 100 kHz bandwidth within the band that contains the highest level of the desired power, based on either an RF conducted or a radiated measurement, provided the transmitter demonstrates compliance with the peak conducted power limits. If the transmitter complies with the conducted power limits based on the use of RMS averaging over a time interval, as permitted under paragraph (b)(3) of this section, the attenuation required under this paragraph shall be 30 dB instead of 20 dB. Attenuation below the general limits specified in §15.209(a) is not required. In addition, radiated emissions which fall in the restricted bands, as defined in §15.205(a), must also comply with the radiated emission limits specified in §15.209(a) (see §15.205(c)).

8.1 Test Procedure

1. Remove the antenna from the EUT and then connect a low RF cable from the antenna port to the spectrum;
2. Set the spectrum analyzer: RBW = 100kHz, VBW = 300kHz, Sweep = auto
Detector function = peak, Trace = max hold



8.2 Test Result

802.11b

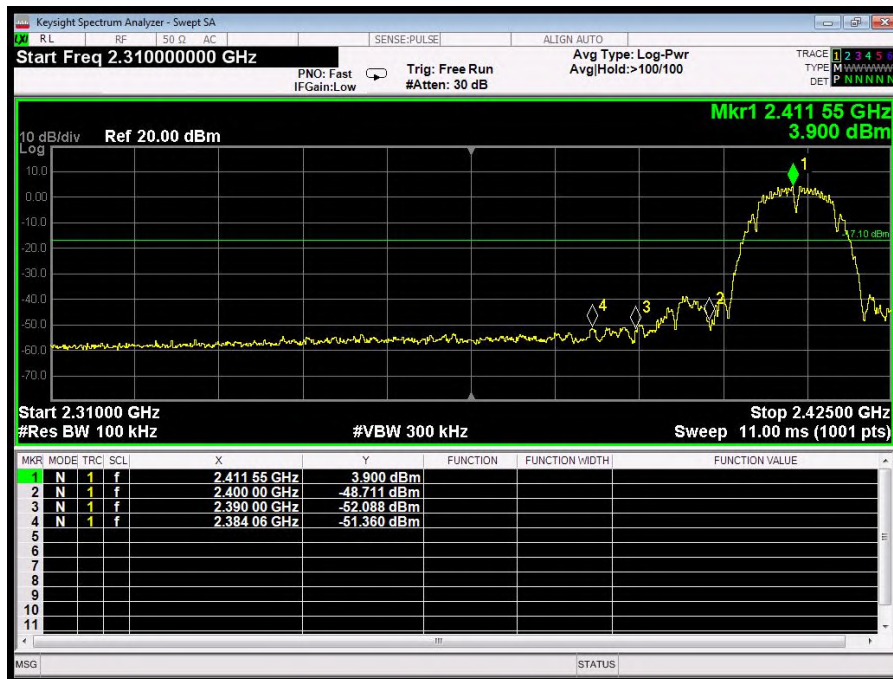



802.11g

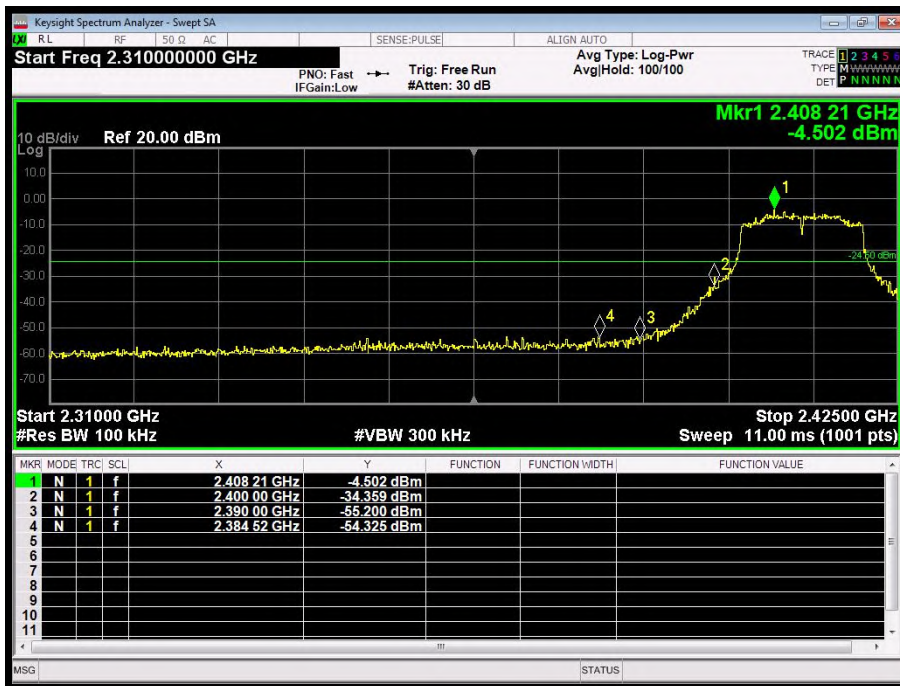



802.11n-HT20

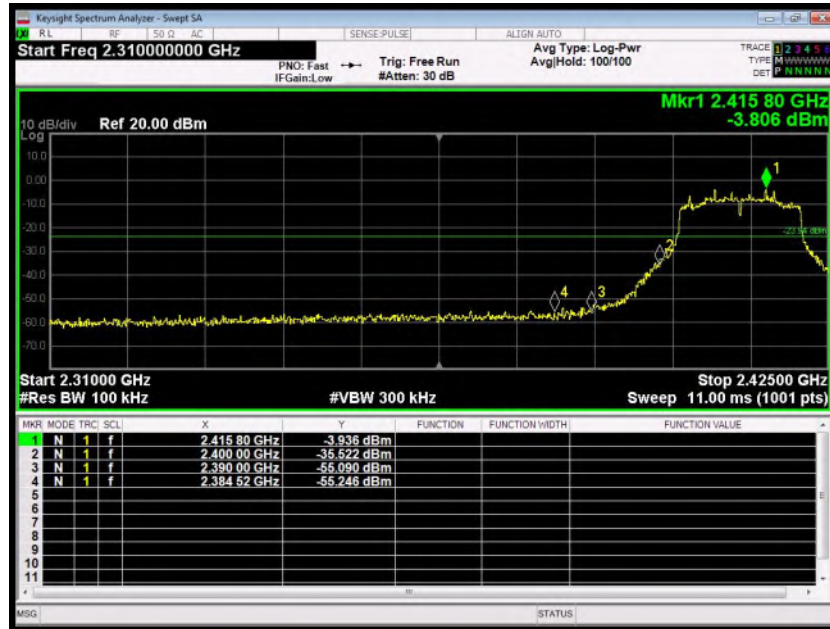



802.11n-HT40

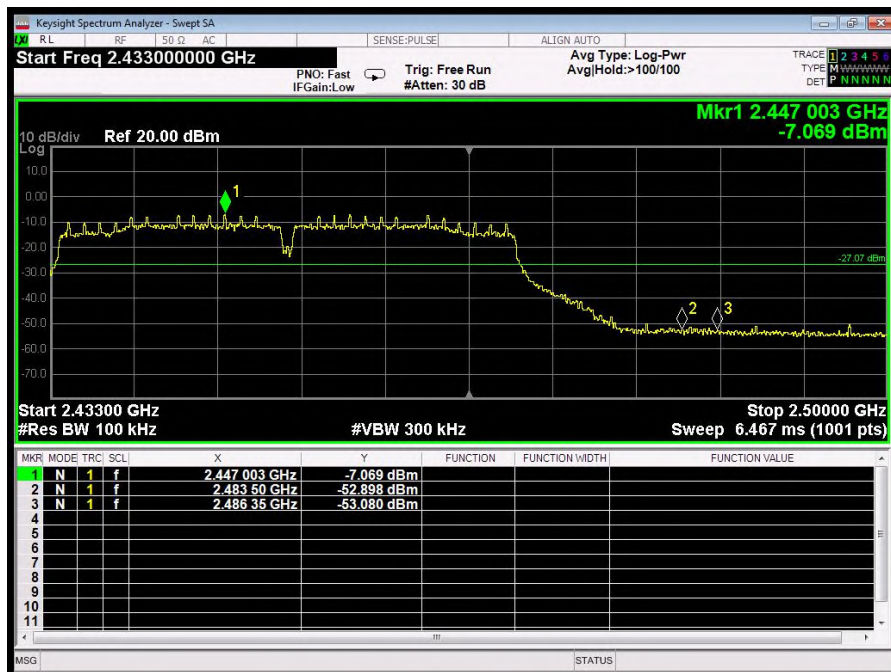



9 6dB Bandwidth Measurement

Test Requirement : FCC CFR47 Part 15 Section 15.247

Test Method : ANSI C63.10:2013

Test Limit : Systems using digital modulation techniques may operate in the 902-928 MHz, 2400-2483.5 MHz, and 5725-5850 MHz bands. The minimum 6 dB bandwidth shall be at least 500 kHz.

9.1 Test Procedure

1. Remove the antenna from the EUT and then connect a low RF cable from the antenna port to the spectrum;
2. Set the spectrum analyzer: RBW = 100kHz, VBW = 300kHz

9.2 Test Result

Modulation	Bandwidth(MHz)			Limit
	Low Channel	Middle Channel	High Channel	
802.11b	9.173	9.153	9.165	≥500kHz
802.11g	15.15	15.16	15.12	≥500kHz
802.11n-HT20	15.16	15.13	15.15	≥500kHz
802.11n-HT40	35.17	35.17	35.17	≥500kHz



802.11b Low Channel

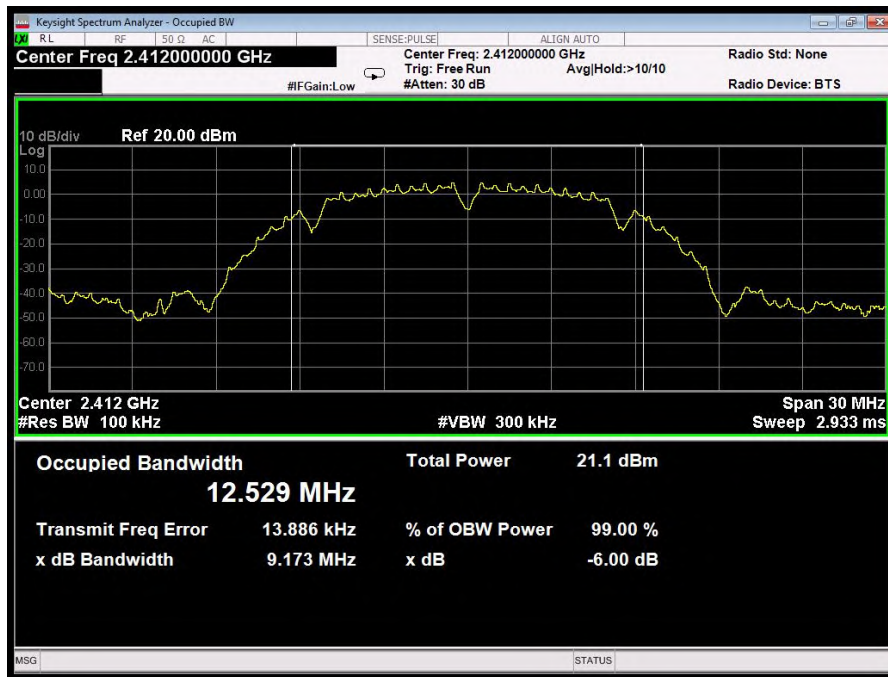

802.11b Middle Channel

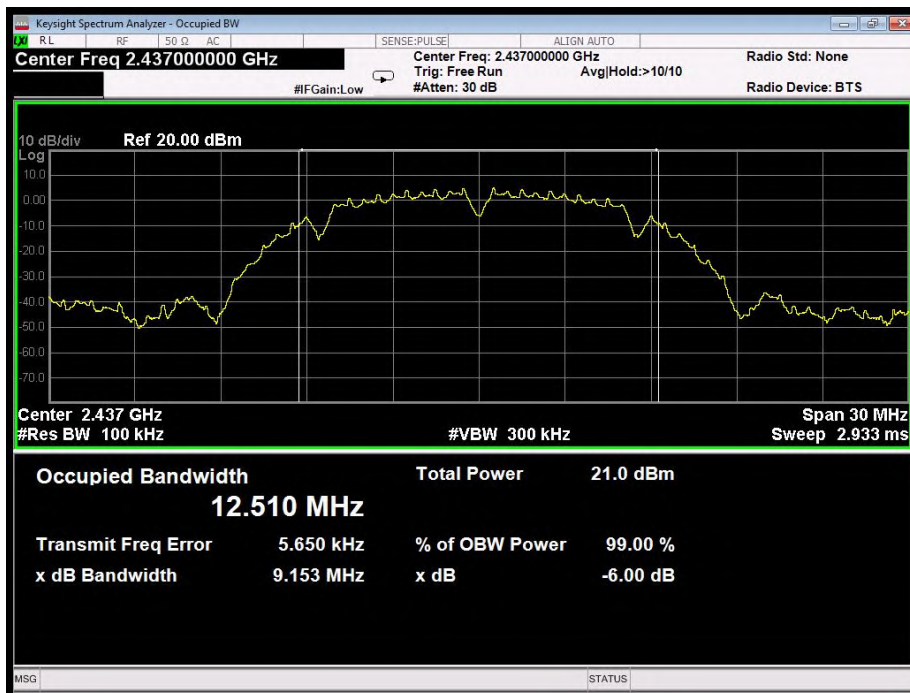



802.11b High Channel

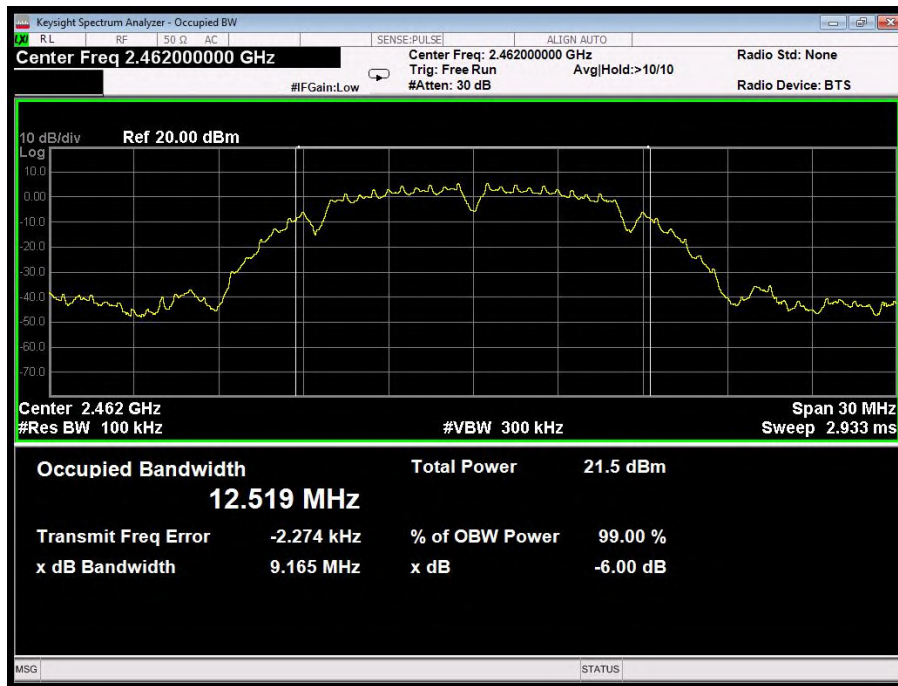

802.11g Low Channel

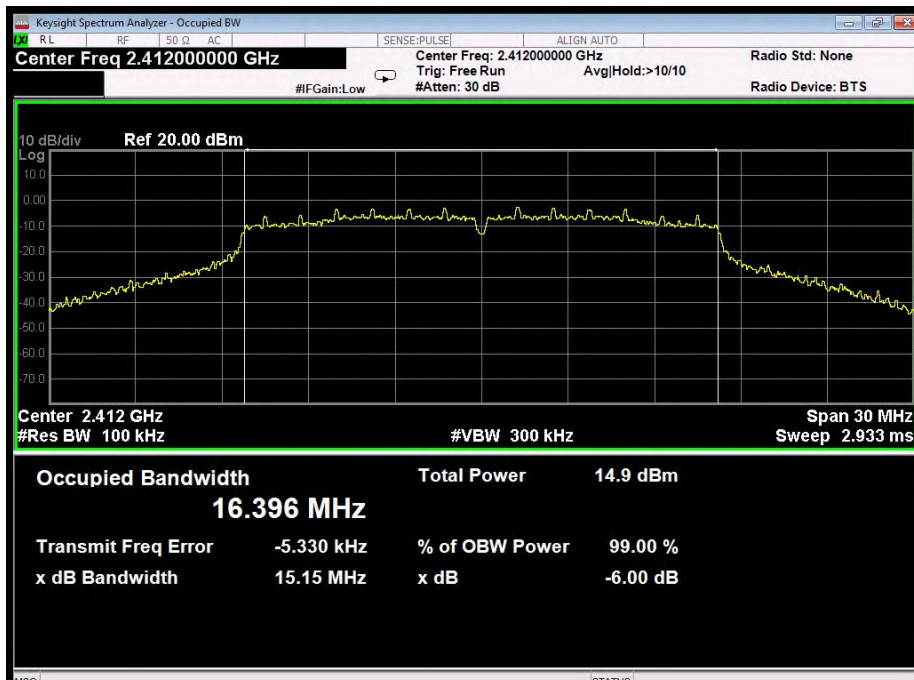



802.11g Middle Channel

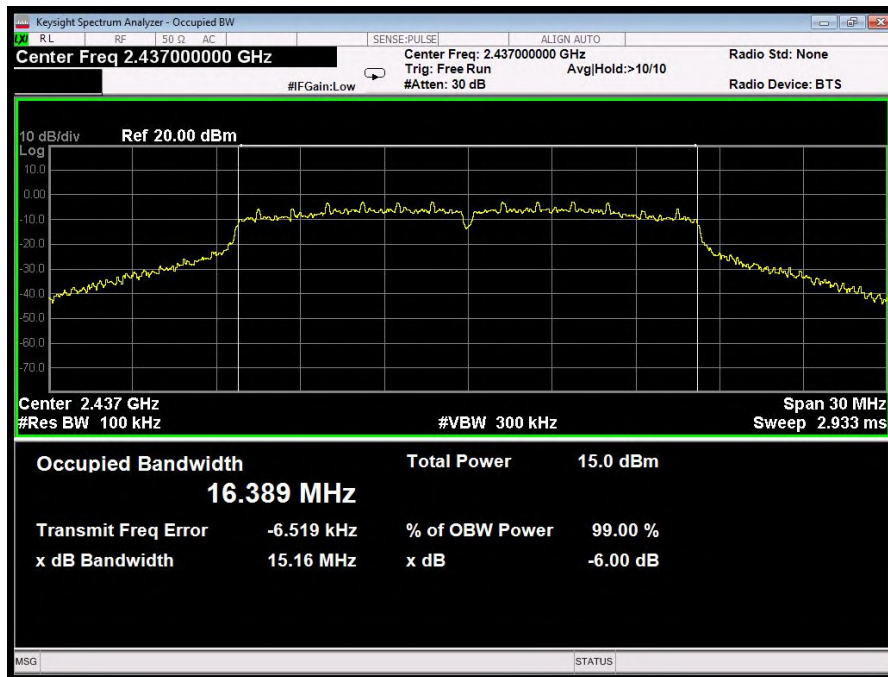

802.11g High Channel

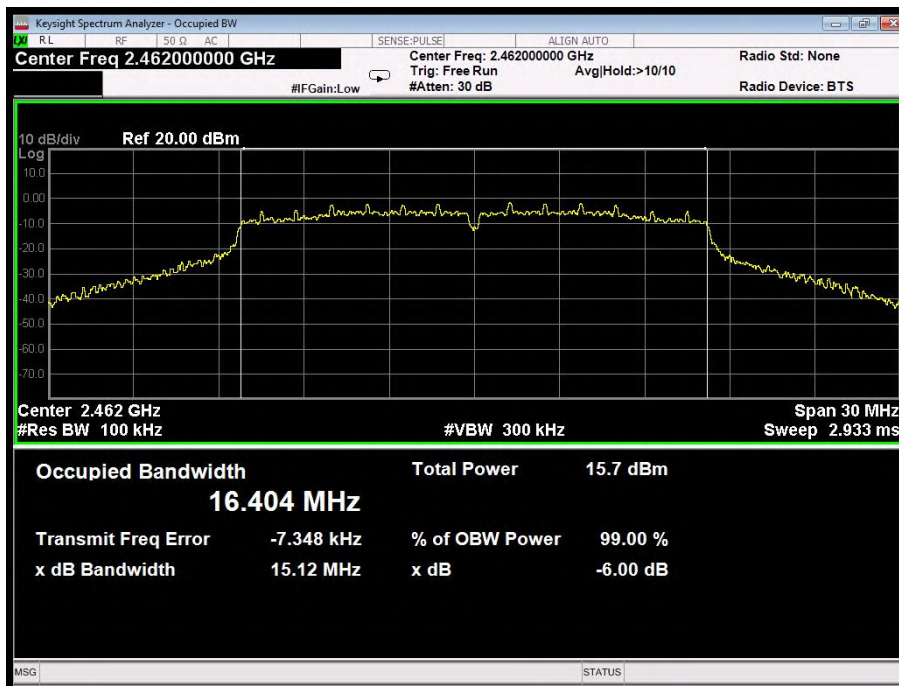



802.11n-HT20 Low Channel

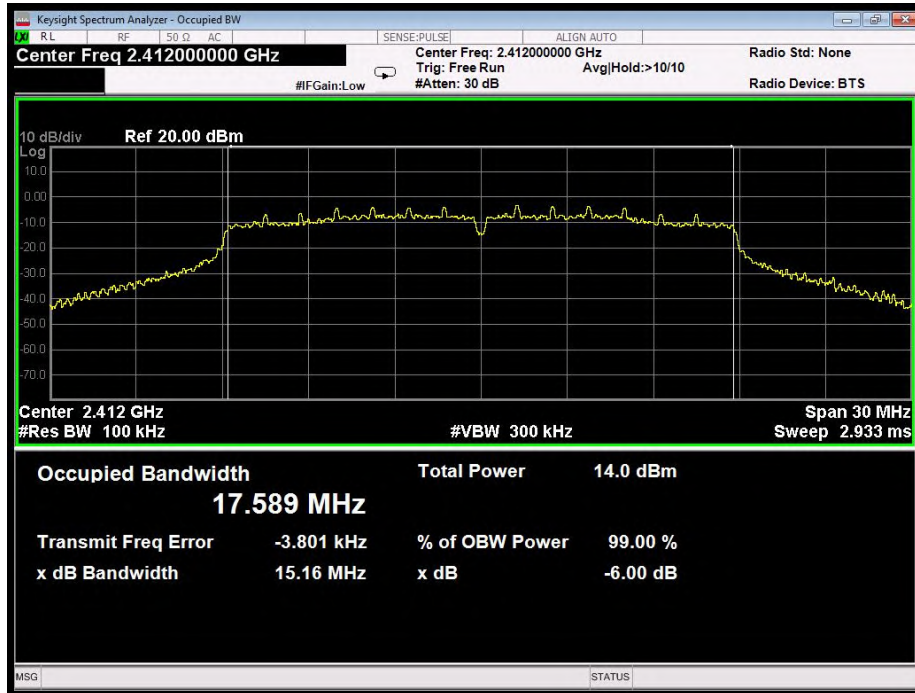

802.11n-HT20 Middle Channel

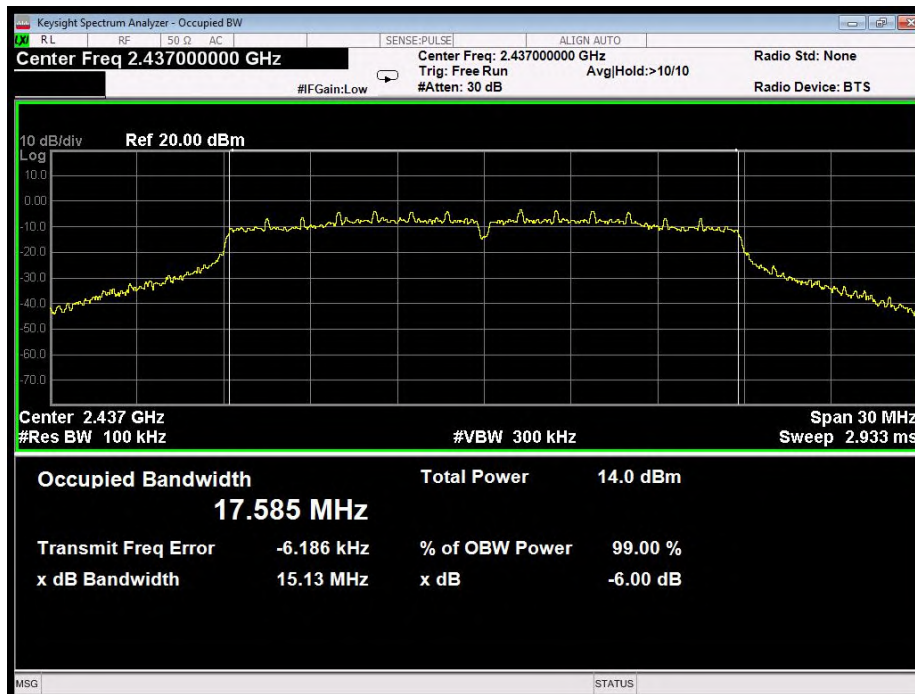



802.11n-HT20 High Channel

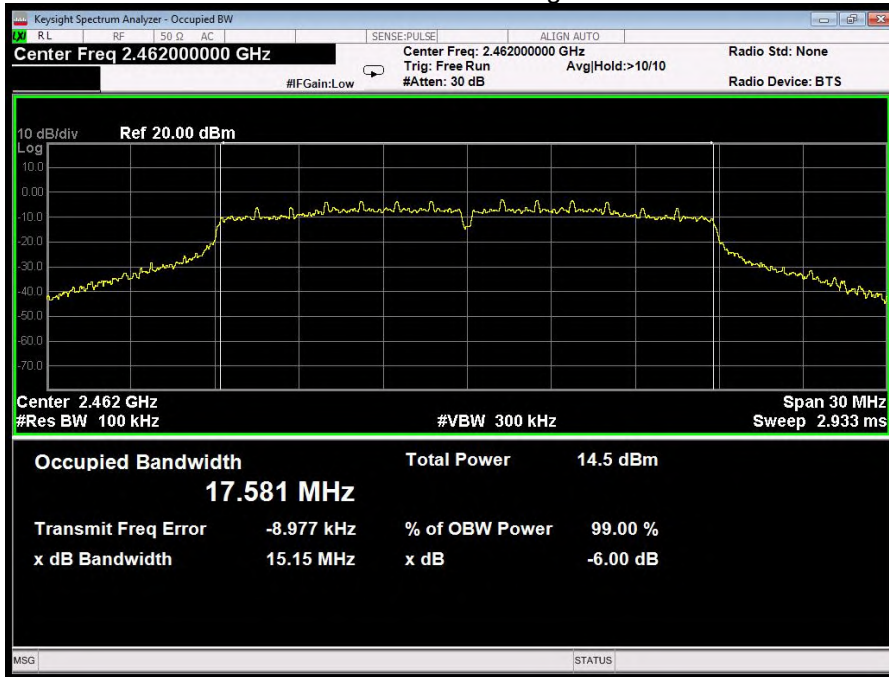

802.11n-HT40 Low Channel

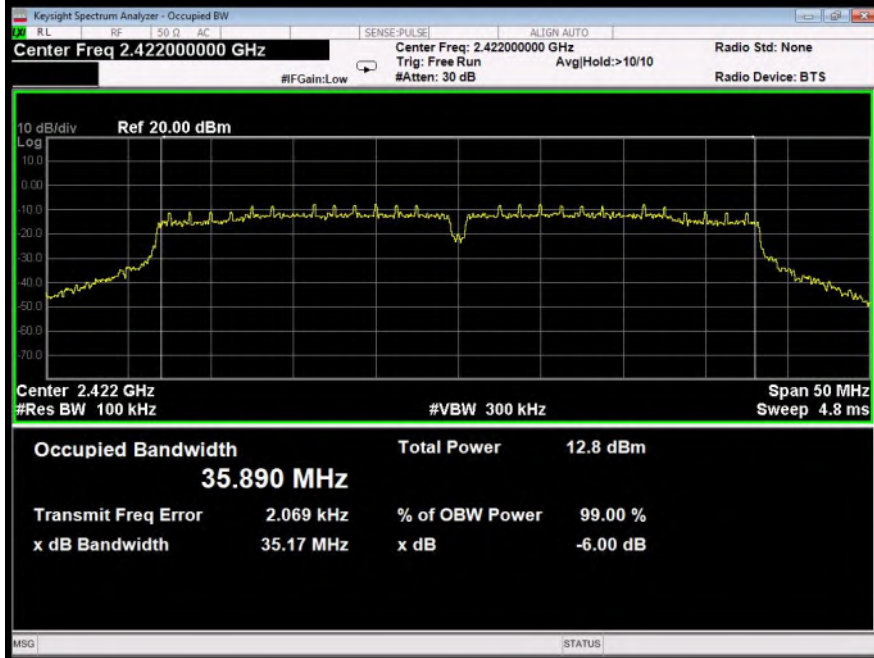



802.11n-HT40 Middle Channel

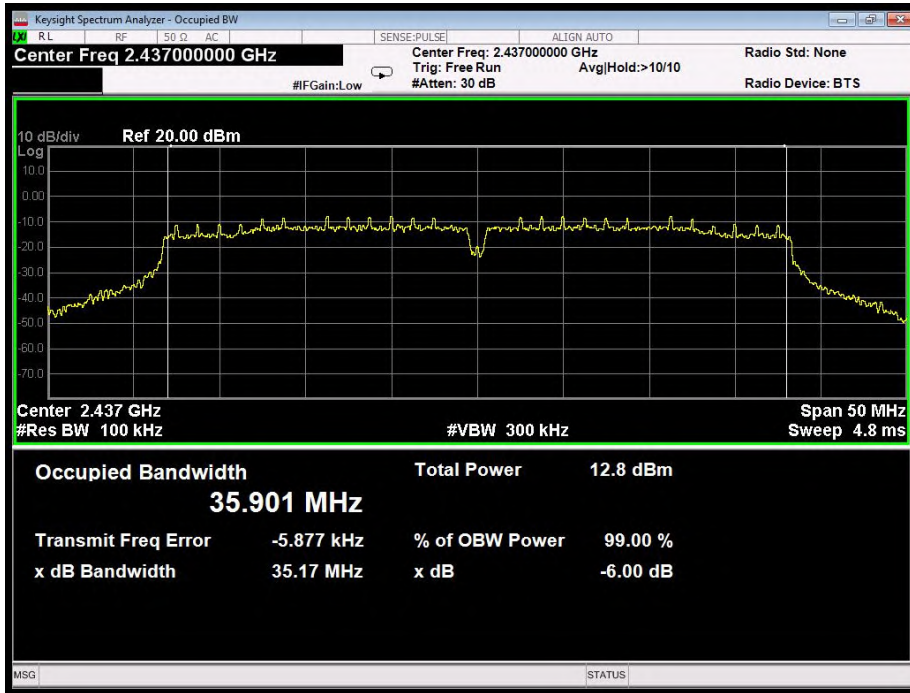

802.11n-HT40 High Channel

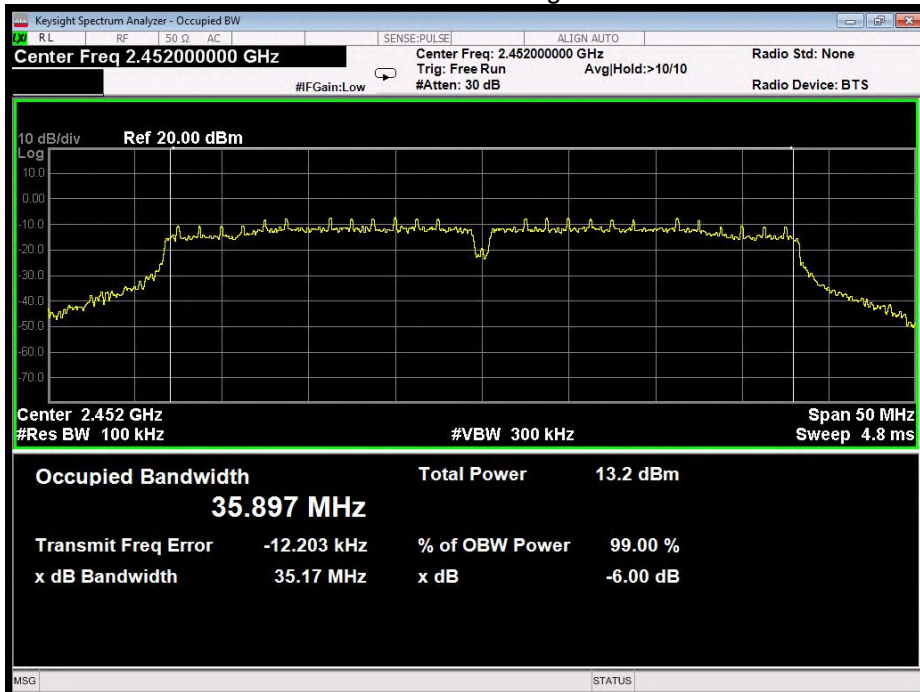



10 Maximum Peak Output Power

Test Requirement : FCC CFR47 Part 15 Section 15.247
Test Method : ANSI C63.10:2013
Test Limit : Regulation 15.247 (b)(3), For systems using digital modulation in the 902-928 MHz, 2400-2483.5 MHz, and 5725-5850 MHz bands: 1 Watt. As an alternative to a peak power measurement, compliance with the one Watt limit can be based on a measurement of the maximum conducted output power.

10.1 Test Procedure

1. The testing follows the Measurement Procedure of FCC KDB No. 558074 D01 15.247 Meas Guidance v05 section 8.3.1.
2. The RF output of EUT was connected to the power meter by RF cable and attenuator. The path loss was compensated to the results for each measurement.
3. Set to the maximum power setting and enable the EUT transmit continuously.
4. Measure the conducted output power and record the results in the test report.

10.2 Test Result

Modulation	Maximum Peak Output Power (dBm)			Limit
	Low Channel	Middle Channel	High Channel	
802.11b	18.11	18.29	18.52	1W(30dBm)
802.11g	14.57	15.15	15.72	1W(30dBm)
802.11n-HT20	13.66	13.71	13.64	1W(30dBm)
802.11n-HT20	12.61	12.58	12.95	1W(30dBm)



11 Power Spectral density

- Test Requirement : FCC CFR47 Part 15 Section 15.247
- Test Method : ANSI C63.10:2013
- Test Limit : Regulation 15.247(f) The power spectral density conducted from the intentional radiator to the antenna due to the digital modulation operation of the hybrid system, with the frequency hopping operation turned off, shall not be greater than 8 dBm in any 3 kHz band during any time interval of continuous transmission.

11.1 Test Procedure

1. Connect the antenna port(s) to the spectrum analyzer input.
2. Configure the spectrum analyzer as shown below:
 Center frequency=DTS channel center frequency
 Span = 1.5 times the DTS bandwidth
 RBW = 3KHz, VBW = 10KHz
 Sweep time = auto couple
 Detector = peak
 Trace mode =max hold
3. Place the radio in continuous transmit mode, allow the trace to stabilize, view the transmitter wave form on the spectrum analyzer.
4. Use the peak marker function to determine the maximum amplitude level within the RBW.
5. If measured value exceeds limit, reduce RBW(no less than 3KHz) and repeat.

11.2 Test Result

Modulation	Power Spectral density (dBm/3kHz)			Limit
	Low Channel	Middle Channel	High Channel	
802.11b	-11.399	-10.631	-10.098	8dBm/3kHz
802.11g	-17.475	-17.722	-16.995	8dBm/3kHz
802.11n-HT20	-17.125	-19.437	-18.291	8dBm/3kHz
802.11n-HT40	-23.876	-22.252	-21.729	8dBm/3kHz



802.11b Low Channel



802.11b Middle Channel





802.11b High Channel



802.11g Low Channel

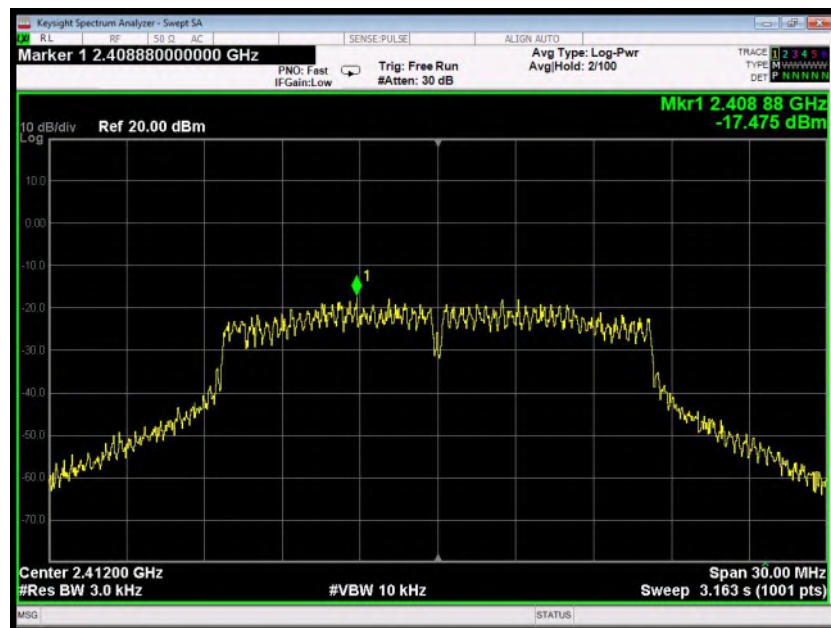



802.11g Middle Channel

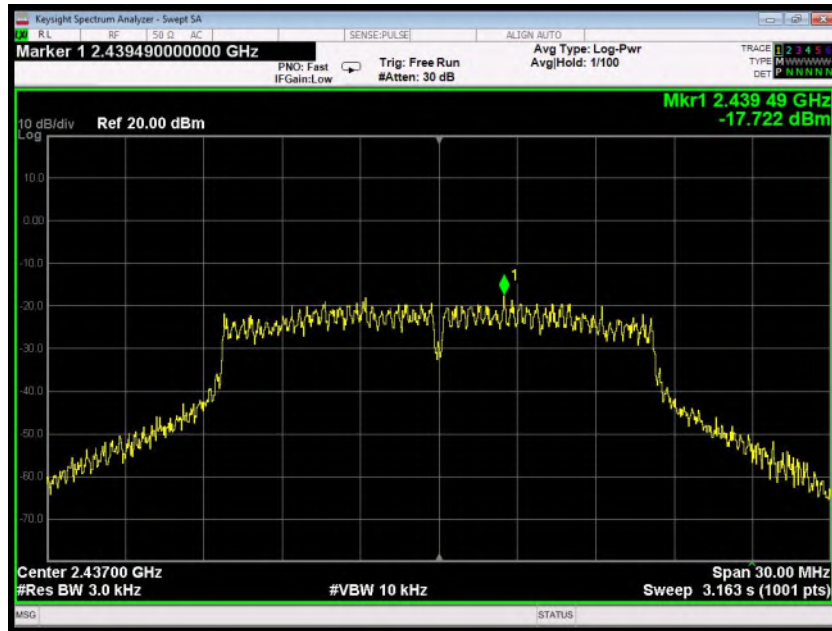

802.11g High Channel

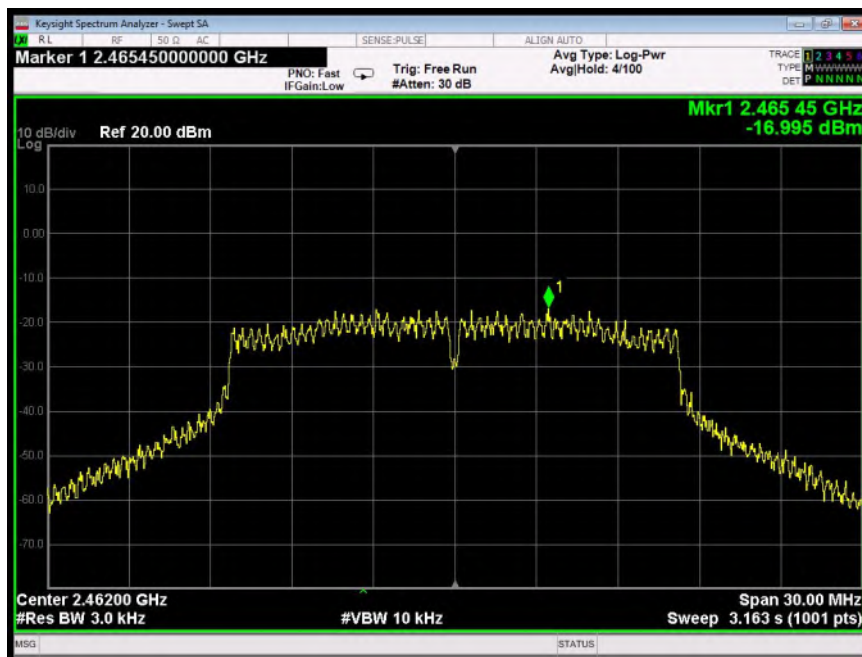



802.11n-HT20 Low Channel

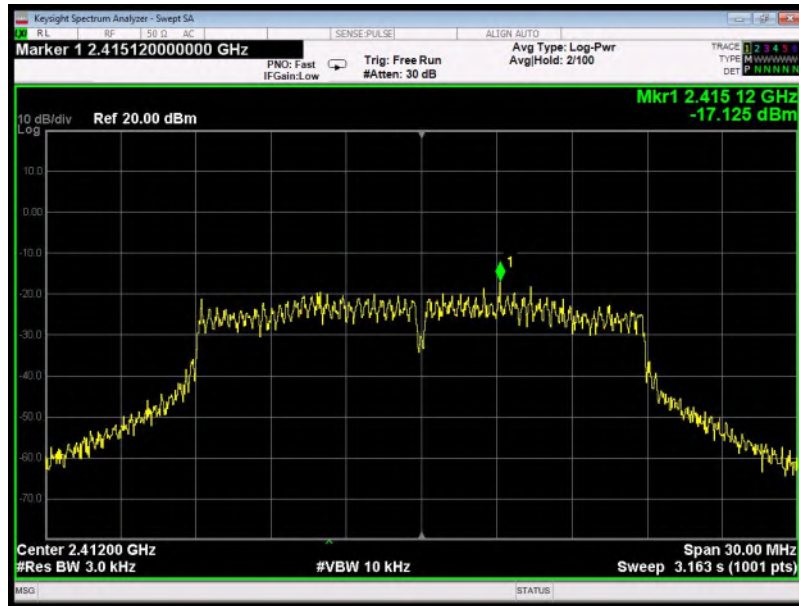

802.11n-HT20 Middle Channel

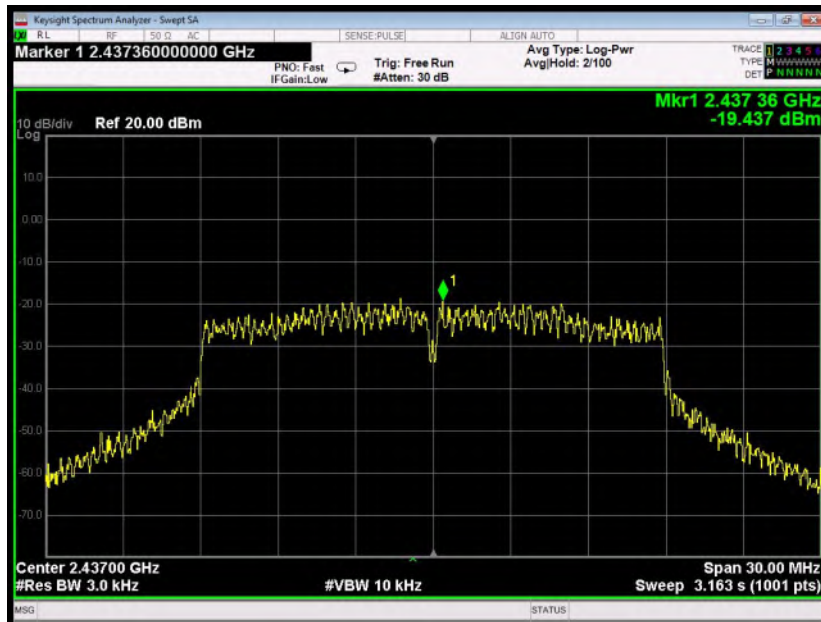

802.11n-HT20 High Channel

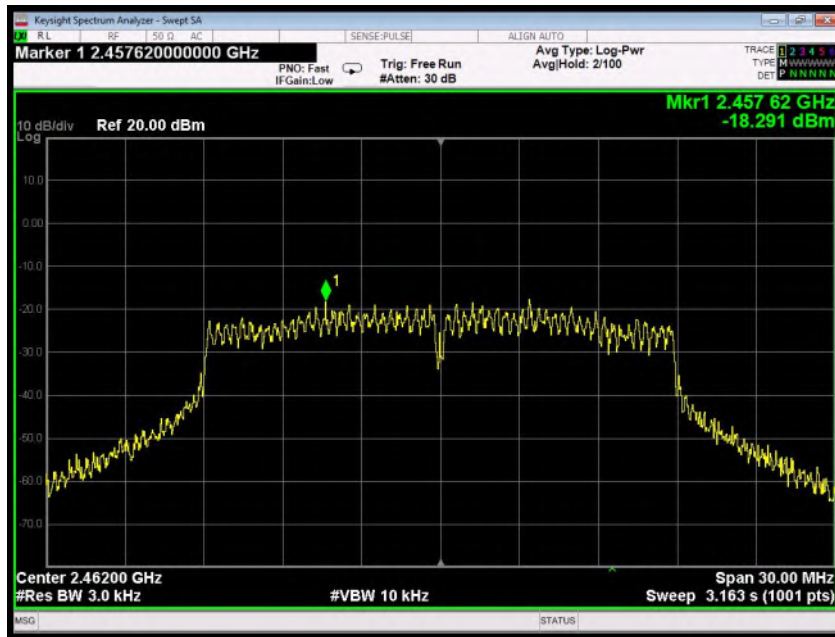

802.11n-HT40 Low Channel

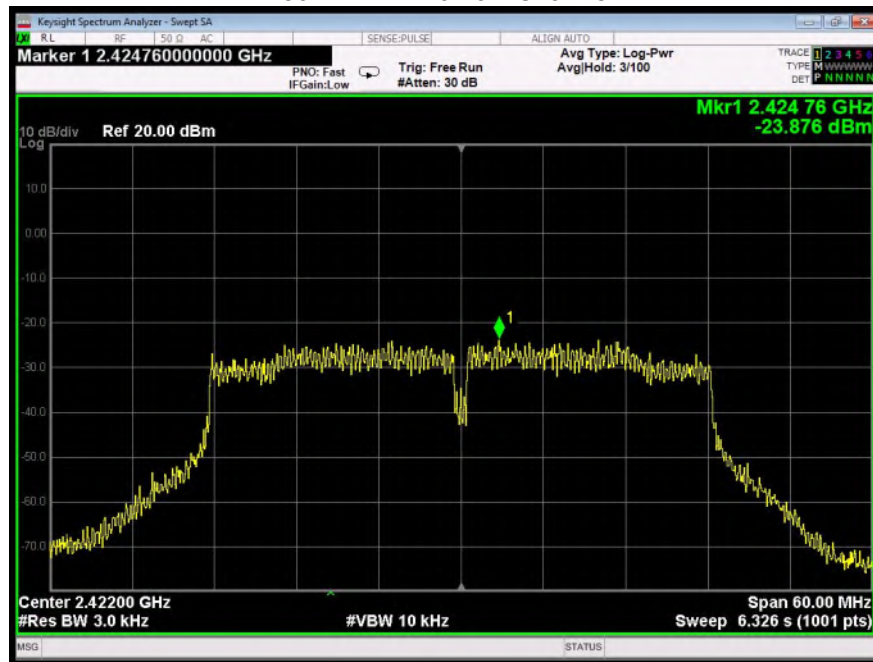



802.11n-HT40 Middle Channel

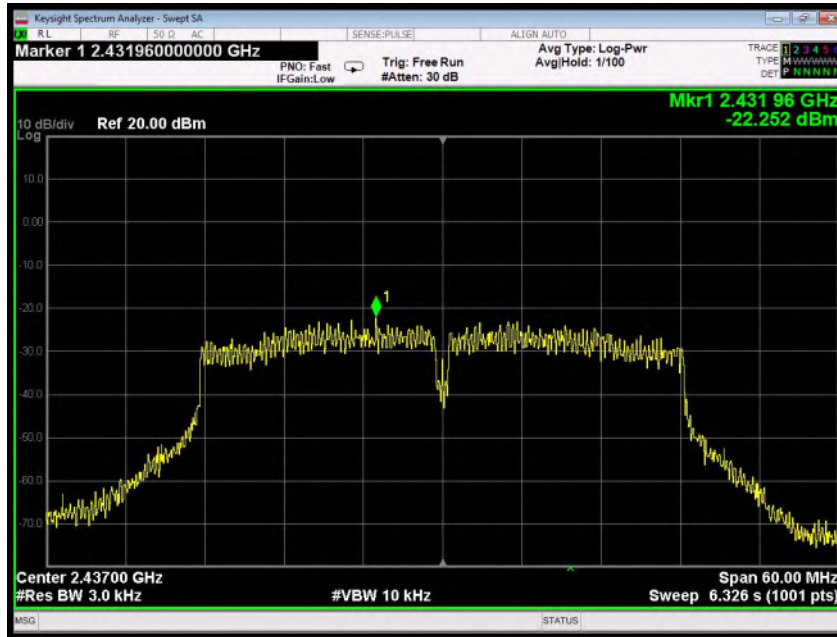

802.11n-HT40 High Channel

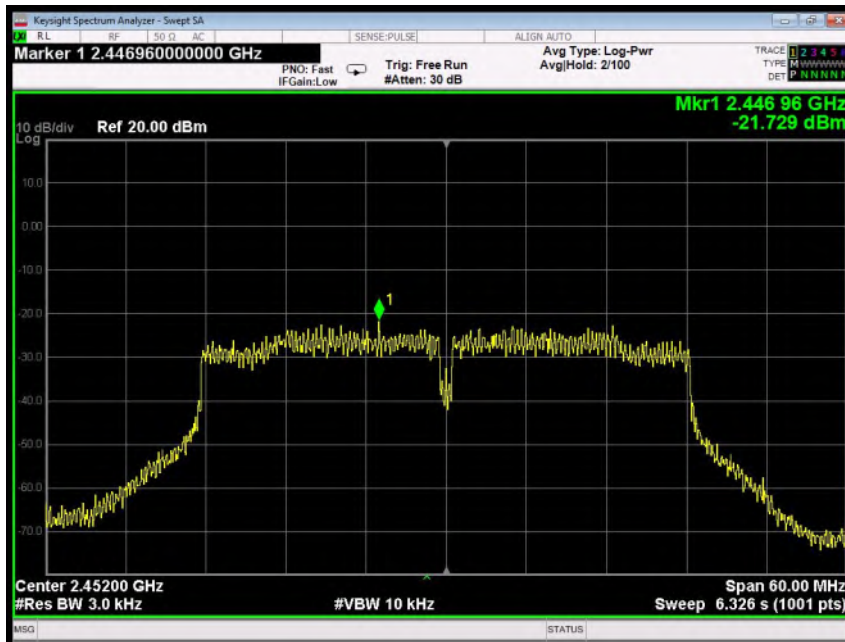



12 Antenna Application

12.1 Antenna Requirement

For intentional device, according to FCC 47 CFR Section 15.203, an intentional radiator shall be designed to ensure that no antenna other than that furnished by the responsible party shall be used with the device. And according to FCC 47 CFR Section 15.247 (b), if transmitting antennas of directional gain greater than 6dBi are used, the power shall be reduced by the amount in dB that the directional gain of the antenna exceeds 6dBi.

12.2 Result

The EUT'S antenna, permanent attached antenna, is FIPA Antenna. The antenna's gain is 3 dBi and meets the requirement.

13 Test Setup

Conducted Emissions

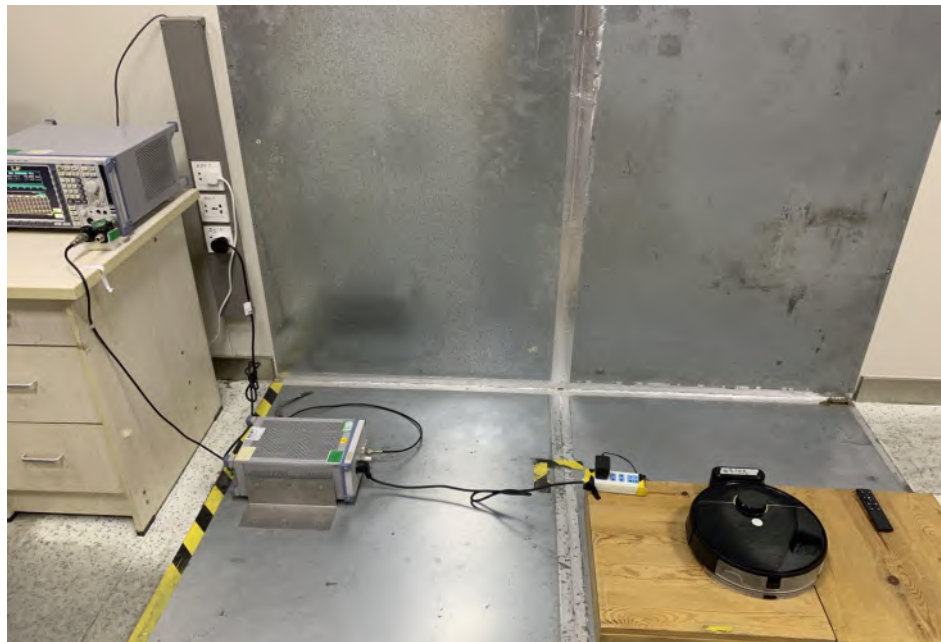

Radiated Spurious Emissions
From 30MHz-1000MHz

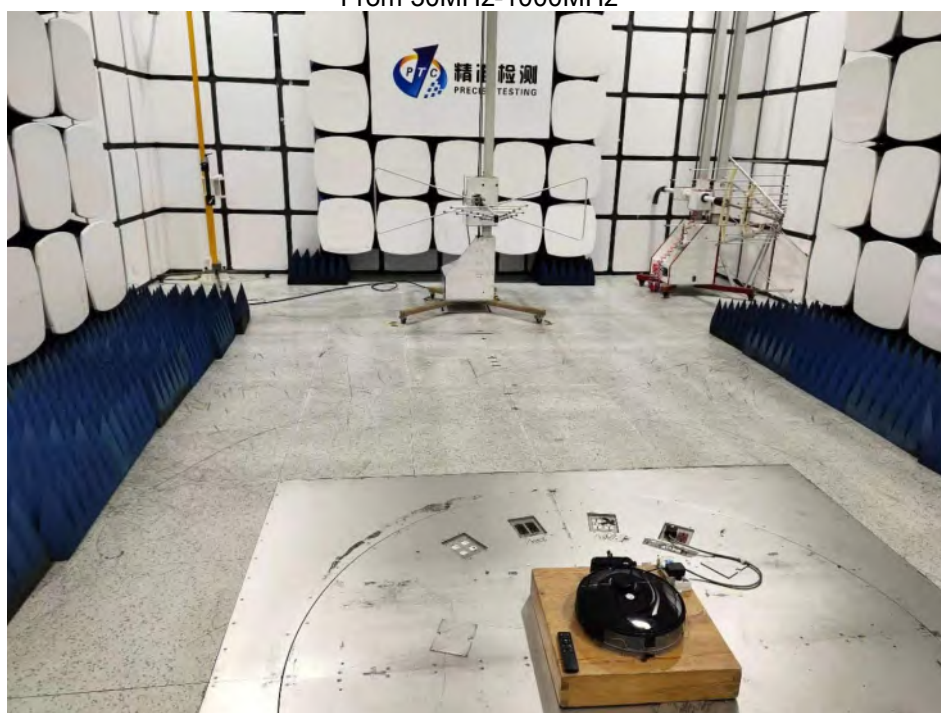

Test frequency from Above 1GHz

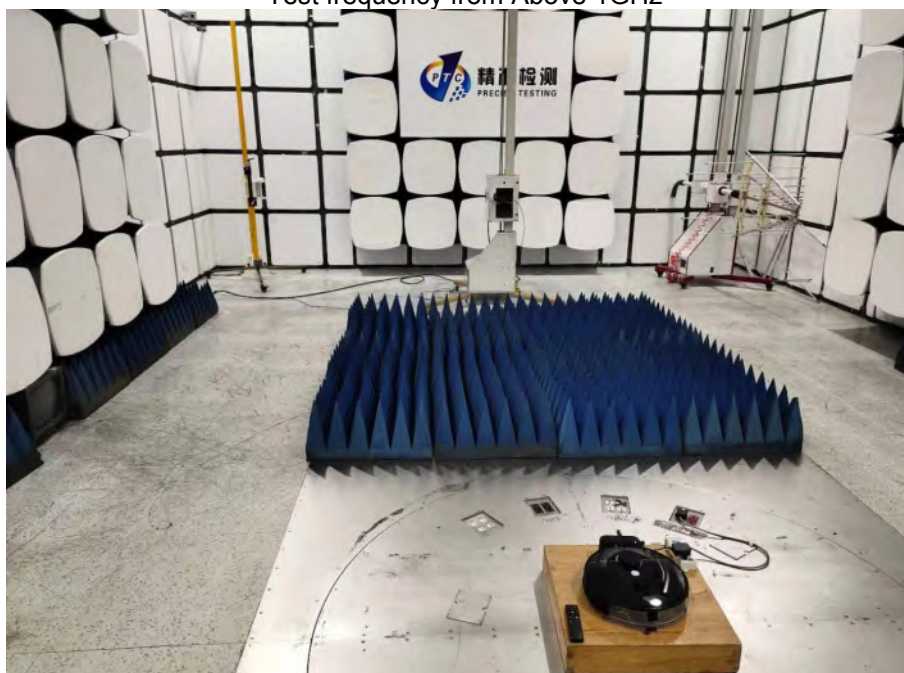

14 EUT PHOTOS

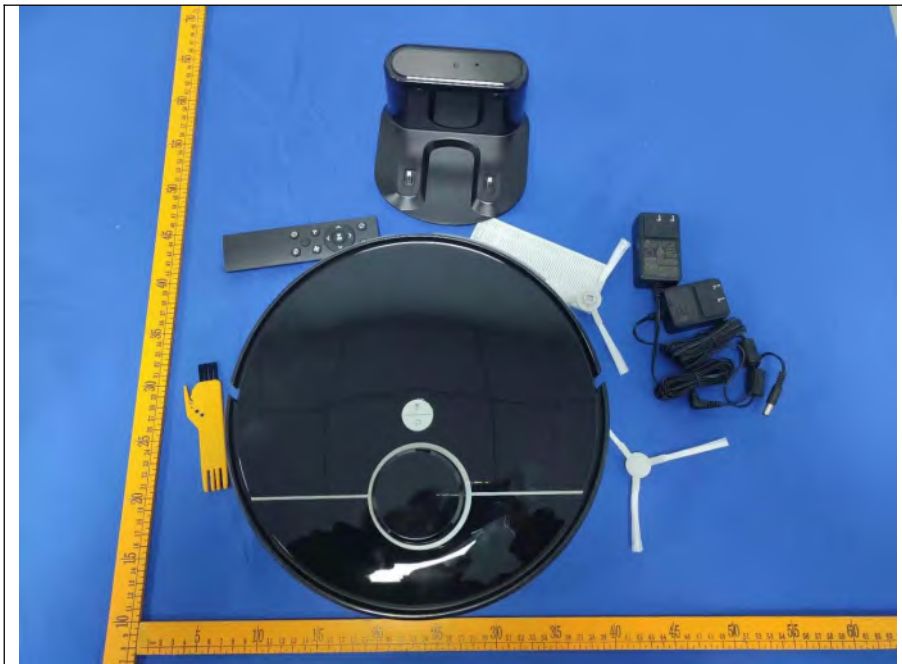

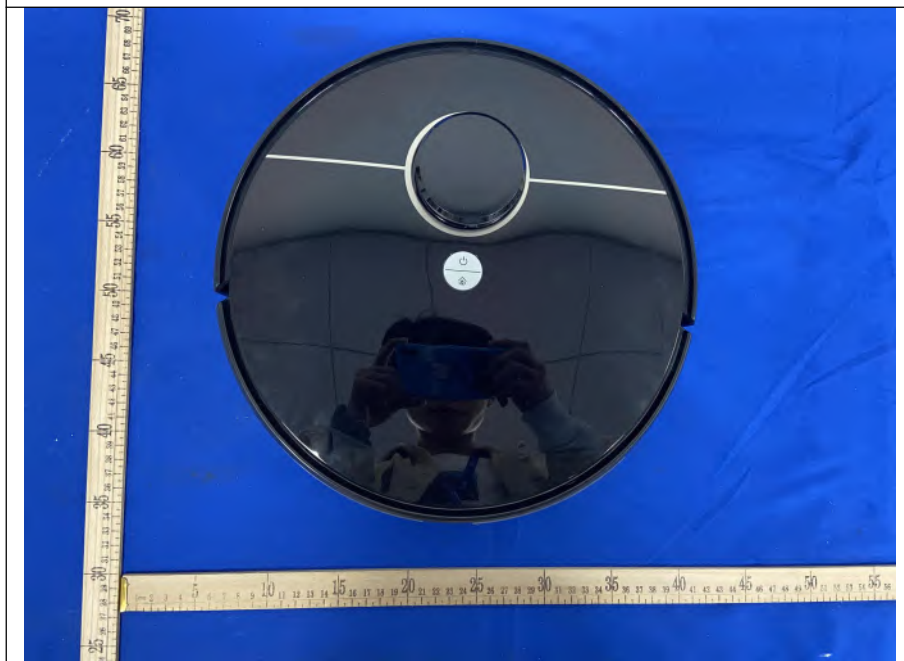

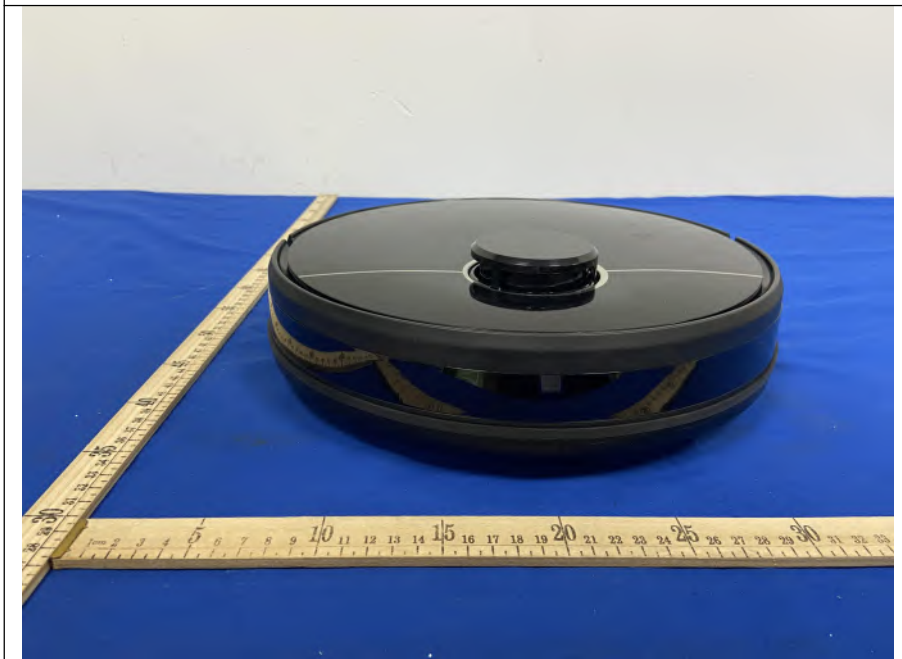

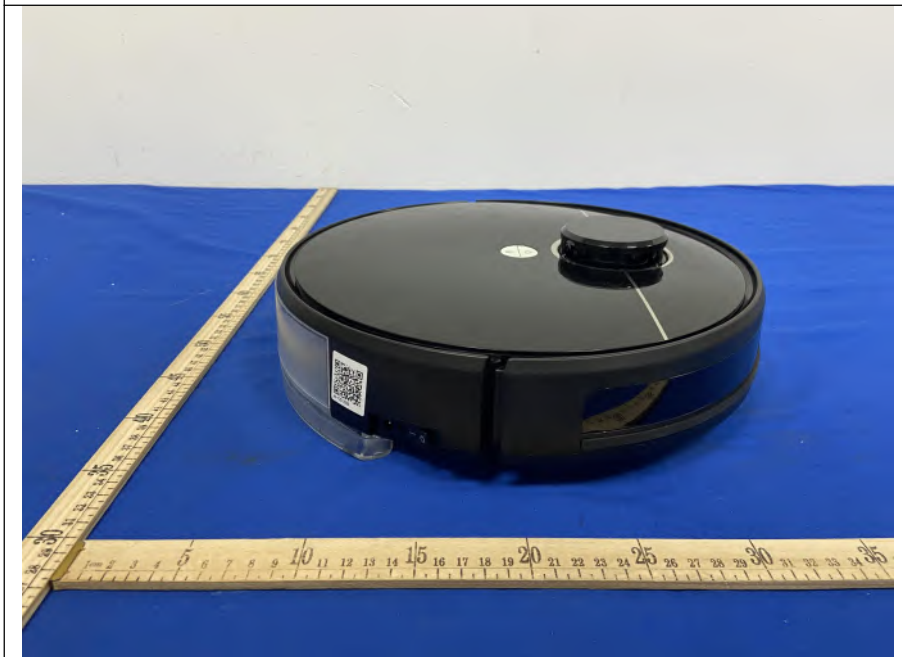

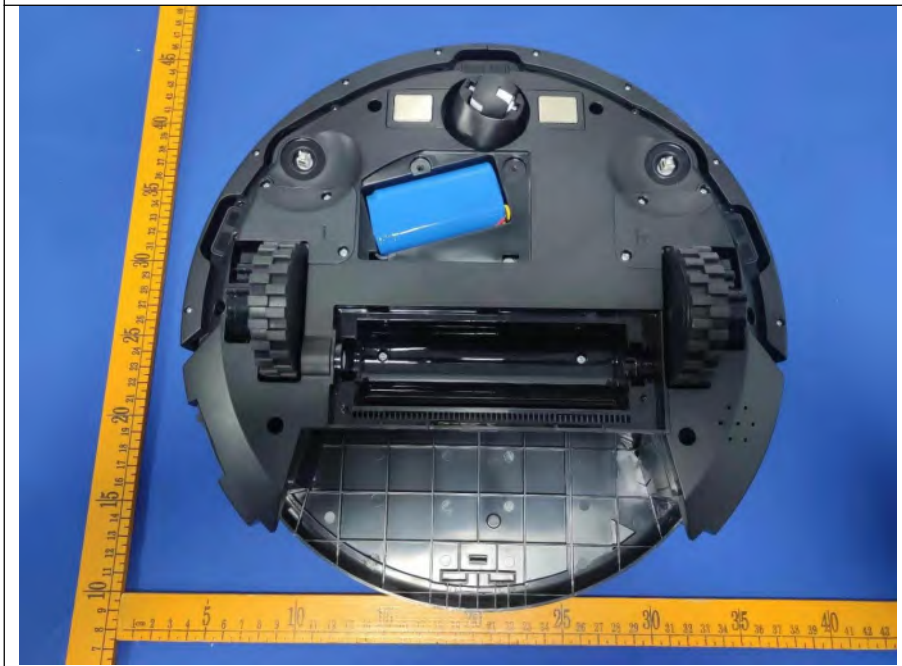

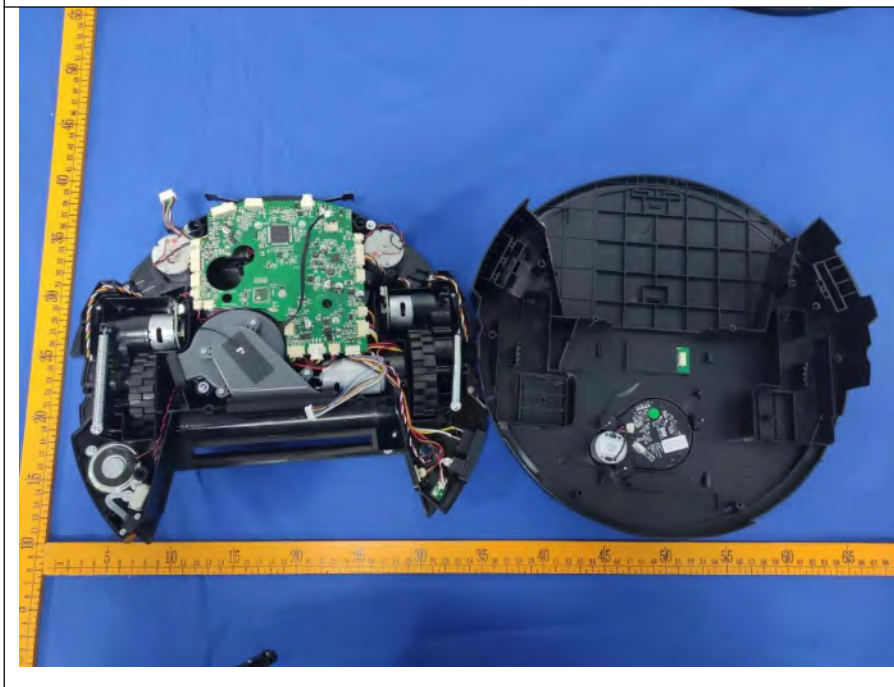

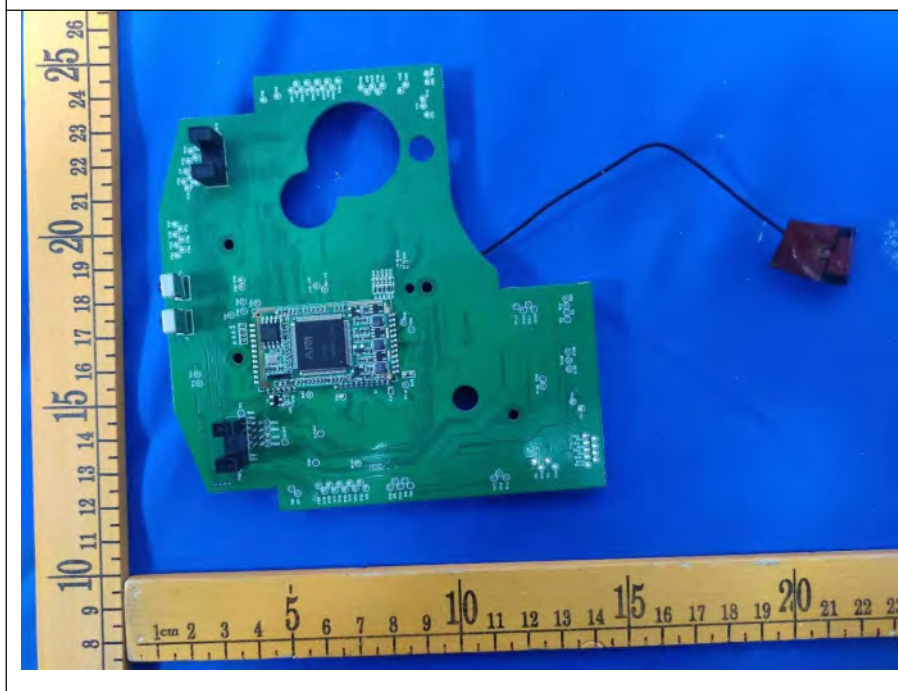

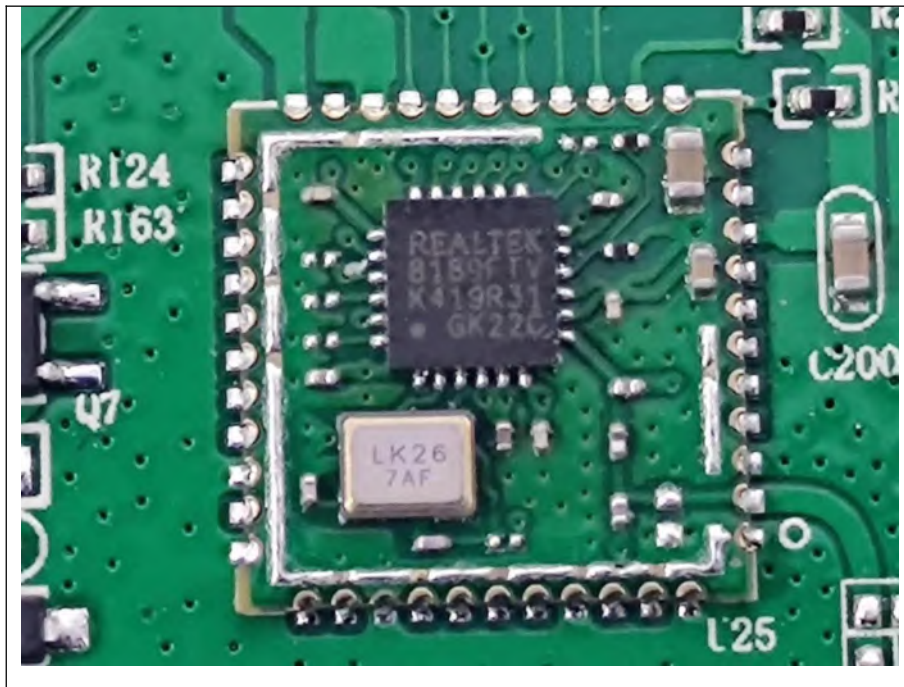

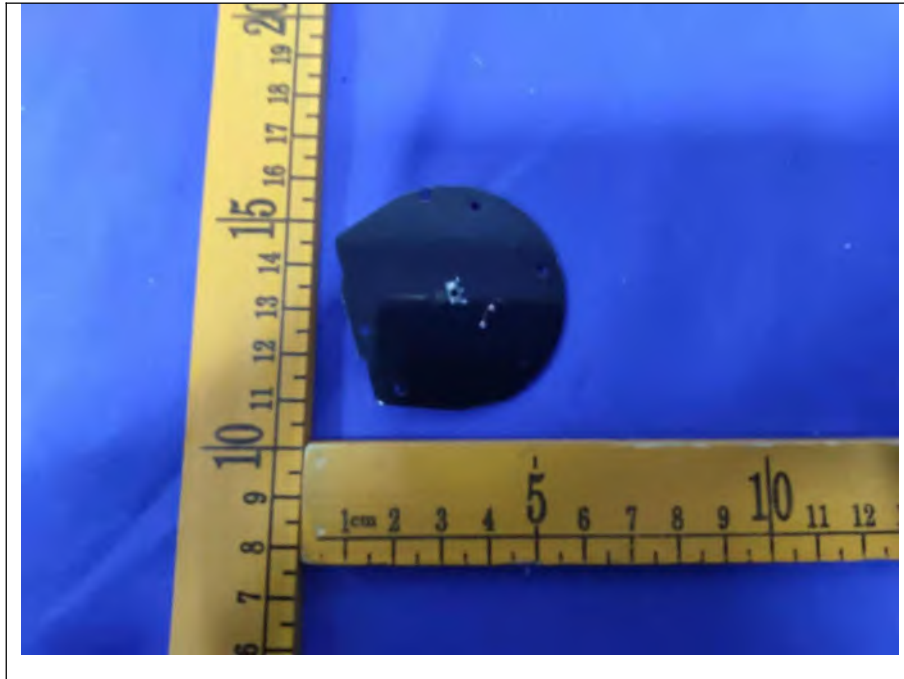

*******THE END REPORT*******