

Robot Vacuum Cleaner User Manual

Please read this manual carefully before using the product and keep it safe.

Safety Regulation

Before using this product, please read the following safety instructions and follow all the safety precautions.

Please read the instruction carefully. Please keep this instruction.

Any operation inconsistent with this instruction manual may cause damage to this product.

Attention

- 1、 Only authorized technicians can disassemble this product. Users are not recommended to disassemble this product by themselves.
- 2、 Please use the original power adapter only. Other adapters may caused damage to this product.
- 3、 Do not touch wires, sockets or power adapters when your hands are wet.
- 4、 Do not use cloth curtains or body parts to roll into the product drive wheels.
- 5、 Do not place this product near cigarette butts, lighters and other smoldering fires.
- 6、 Please clean the product after charging.
- 7、 Do not bend wires excessively or place heavy objects and sharp objects on the machine.
- 8、 This product is an indoor household product. Do not use it outdoors.
- 9、 Do not sit on the product.
- 10、 Do not use this product in wet environment (e.g. bathroom).
- 11、 Before using this product, please remove all vulnerable items (e.g. glasses, lamps, etc.) on the ground as well as items (e.g. wires, paper sheets, curtains) that may entangle the side brushes and air suction passages.
- 12、 Do not put this product in a place where it is easy to fall (e.g. on desks and chairs).
- 13、 Please turn off the main power switch on the side of machine during transportation or not use for long time.
- 14、 Please carefully check whether the power adapter is connected to the socket before use, otherwise the battery may be damaged.
- 15、 To prevent tripping, please inform other members of the house when this product works.
- 16、 Please empty the dust box before using this product when the dust box is full.
- 17、 The temperature used for this product is 0 to 40 degrees celsius.
- 18、 Do not use this product in high temperature environment.
- 19、 Please remove the battery from the machine before the product is scrapped.
- 20、 Please make sure that this product is not powered on when removing the battery.
- 21、 Please recycle the discarded batteries safely.

Warning

- 1、 Use only the original rechargeable battery and charging station specially equipped by the manufacturer. Non-rechargeable batteries are strictly prohibited, please refer to "product parameters" for battery specification information.
- 2、 It is forbidden to use products in environments with open flames or fragile objects.
- 3、 It is forbidden to use products in extremely hot (above 40 °C) or extremely cold (below 0 °C) weather.
- 4、 It is forbidden for human hair, clothes, fingers and other parts to approach the opening and operating parts of the product.
- 5、 It is forbidden to use products on wet or stagnant ground.
- 6、 It is forbidden for products to absorb any articles such as stones and waste paper that may clog products.
- 7、 It is prohibited for the product to absorb any inflammable substances, such as petrol, toner and toner for printers or photocopiers. It is also prohibited to use the product in clean areas with flammable items.
- 8、 It is forbidden for products to absorb any burning articles, such as cigarettes, matches, ashes and other articles that may cause fire.
- 9、 It is forbidden to place articles at the suction port. Do not use the product when the suction port is blocked. Clean up dust, cotton wool, hair etc. at the suction port to ensure smooth air circulation at the suction port. Use the power cord carefully to avoid damage.
- 10、 It is forbidden to use the power cord to drag or pull the products and the product charging station. It is forbidden to use the power cord as a handle. It is forbidden to clamp the power cord in the crack of the door.
- 11、 It is forbidden to pull the power cord at sharp corners and corners.
- 12、 It is forbidden for the product to run on the power cord while the power cord should be far away from the heat source. Do not use damaged charging station. Even if the product has been severely damaged, burning of the product is prohibited, which may lead to explosion of the battery of the product.

Product Composition/ Package Contents

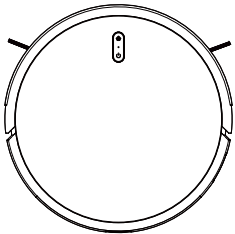

Host

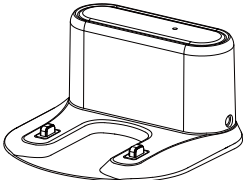

Charging Base

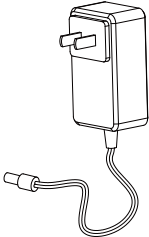

Power Adaptor

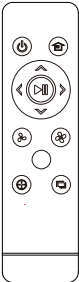

Remote Controller (optional)

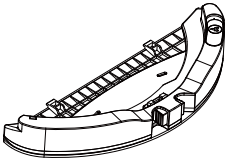

Water Tank(optional)



Mop (Optional)



Cleaning Brush

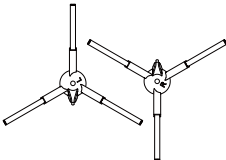

Side Brush

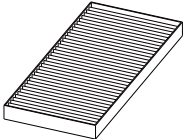

HEPA

Product Composition / Part Contents

TOP

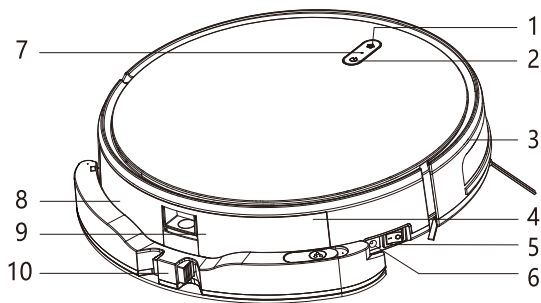

- 1、 Home
- 2、 Start/Pause
- 3、 Front Bumper
- 4、 Dust Bin
- 5、 Power Switch
- 6、 Charge hole
- 7、 WIFI indicator
- 8、 Water Tank
- 9、 Dustbin Release Button
- 10、 Water Tank Release Button

BOTTOM

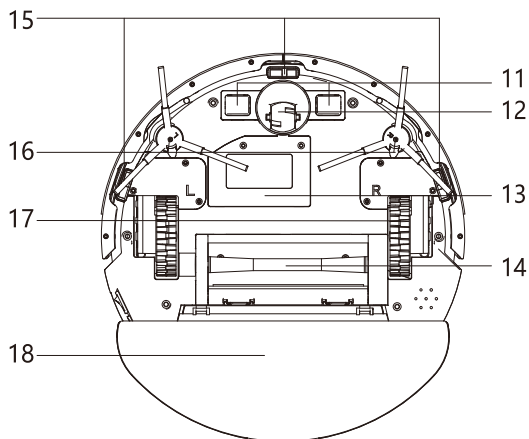

- 11、 Charge Plate
- 12、 Universal Front Wheel
- 13、 Battery
- 14、 Main Roller Brush
- 15、 Ground Sensors
- 16、 Side Brush
- 17、 Wheel
- 18、 Water Tank

Dust Bin

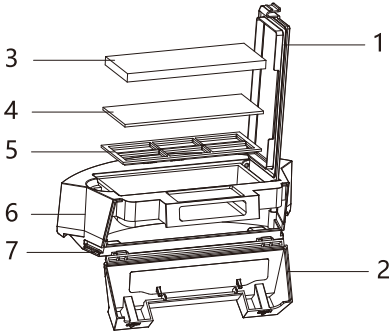

- 1、 Dust Bin Top Cover
- 2、 Dust Bin Side Cover
- 3、 HEPA Filter
- 4、 Sponge Filter
- 5、 Primary Filter
- 6、 Dust Bin Top Part
- 7、 Dust Bin Bottom part

Water Tank

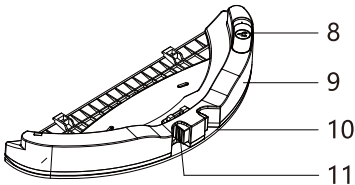

- 8、 Water Injection hole
- 9、 Water Tank
- 10、 Mop
- 11、 Water Tank Release Button

Remote Controller

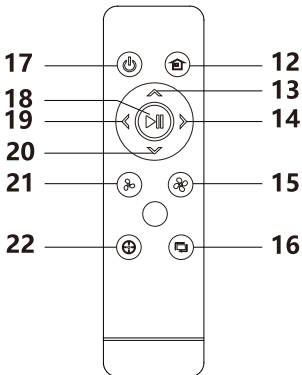

- 12、 Go Home
- 13、 Forward
- 14、 Turn Right
- 15、 Suction Power Adjustment
- 16、 Along the wall
(valid in specify model)
- 17、 ON/OFF
- 18、 Pause/Start
- 19、 Turn Left
- 20、 Turn Back
- 21、 Suction Power Adjustment
- 22、 Spot Cleaning

Product Usage/Preparation

Take out Water Tank

Press the water tank release button then take out water tank.

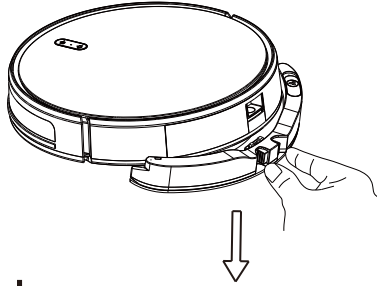

Install Side Brush

Install the side brush according to the left and right (L/R).

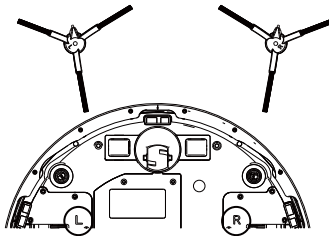

Remove the Bumper Protective Strip

Before using the robot, please remove the protective strip from the robot.

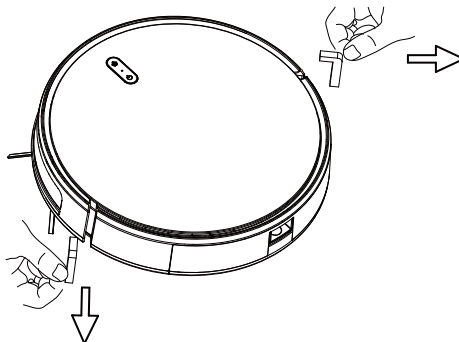

Product Use/Host Charging

1. Place the Charging Base&Connect the Power Supply.

Place the charging station against the wall and on a flat ground. Do not place articles within the range of 0.5m left and right and 1.5m ahead.

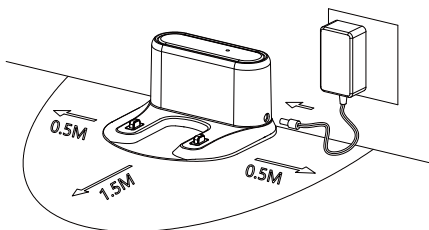

2. Turn on the Main Switch Power.

"I" means turn on robot,
"O" means turn off robot.

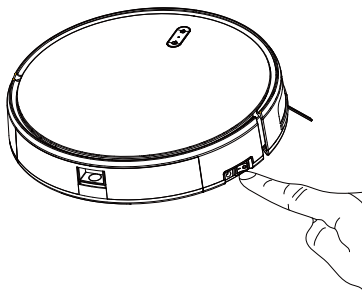

3. Charge the robot: Put the robot on charging base to charge, or use power adaptor to direct charge.

When charging, the indication light flashes(yellow light);

When charging complete, the indication light turn to green once charging complete

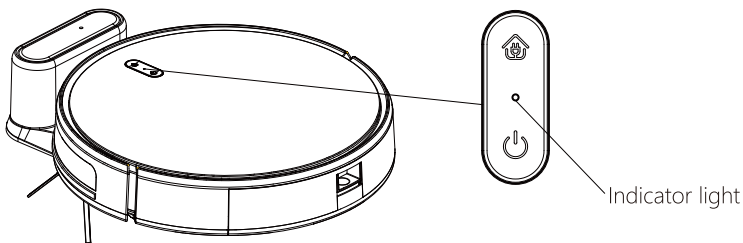

During Cleaning , the robot can sense that its power is insufficient and automatically start the recharging mode to find the charging base to recharge..

You can also command the robot to start the recharging mode by recharging button  on the remote controller/APP.

Charging Attention:

1. The charging station cannot be used in environments with strong reflection such as direct sunlight or nearby mirrors.
2. In order to ensure the normal working hours, please fully charge the robot before use. The charging time is about 6 hours.
3. When charging, please remove the water tank assembly from the robot vacuum, so as to ensure the safety of charging and prevent wet mops from damaging the floor.
4. When Charging, All buttons except start button on the host/remote/APP will make the robot abnormal.

Product Use/Water Tank

Water Tank is an optional function.

1. Open the water injection port of the water tank and plug the water injection cap.

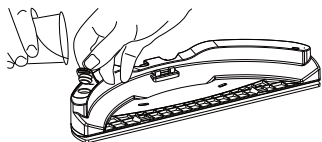

2. Install the Mop.

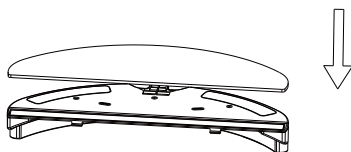

3. Take out dust bin.

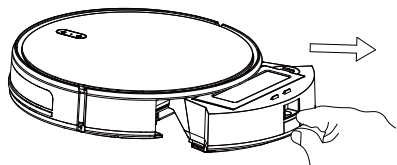

4. Install the water tank into dust bin.

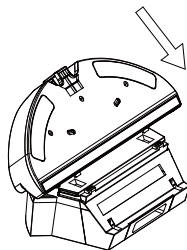

5. Install the dust bin+ water tank on the host.

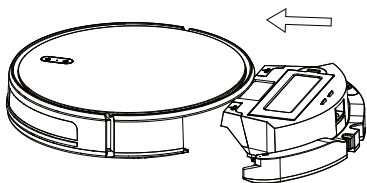

6. Start mopping the floor.

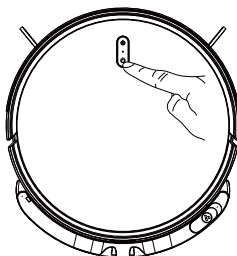

* Please don't use water tank on the carpet, if your room is with carpet, please use virtual blocker to stop the robot enter carpet.

* Mopping mode completed, please clean the leftover water in the water tank and re-install mop to clean it.

Product Use/Start Cleaning

According to different cleaning needs, the product has a variety of cleaning modes to choose from. You can start various cleaning modes through a host, remote control or app.

Auto Cleaning

Applicable Scene: It's the most common cleaning way, the robot makes planned cleaning according to environment surroundings then clean the whole house in a zigzag way.

Setting Method: Turn on the main switch, after robot indicate its ready, then press start button on the robot or press  on the remote or start.

Spot Cleaning

Applicable Scene: Suitable for the floor where garbage is concentrated, the robot cleans the floor in "spiral" route, cleaning completed, the robot will return to where it starts then stop cleaning.

Setting Method: Press the button  on the remote or start on APP to start spot cleaning.

Border Cleaning

Applicable Scene: For indoor border cleaning, the robot cleans along the perimeter of fixed objects (such as walls), and returns to the charging station after the border cleaning finished (except remote controller/ APP control).

Setting Method: Press the button  on the remote controller or start on APP to start border cleaning.

Manual Control

Applicable Scene: Suitable for manual control cleaning.

Setting method: Click on the buttons  on the remote controller to move forward and backward and turn right or left.

Suction Power Adjustment

Applicable Scene: Adjust suction power or water seepage according to different floor environments.

Setting Method: In auto cleaning mode, press  on the remote controller or use APP to control to adjust suction power.

* Attention: Suction power adjustment only effective under auto cleaning mode

Product use/pause,wake up and shut down

Pause:

During the operation of the host, press start button on the host or "⏸" button on APP or "▶⏸" button on remote controller to pause the robot.

Wake Up:

If the host stops working for more than 3 minutes, it will automatically enter into sleep mode (all lights on the host are off). You can wake up the host by pressing the host button "start" or any button on the remote controller or "start" button on APP.

Shut Down:

After the host stops working, turn off the main switch, all the lights on the host are all off means the host has been shut down.

* After the host finish working, please keep the host on and charged for next time work. (If long time no use, please turn off the main switch)

Component maintenance/dust bin&Filter

1. Press dustbin release button to take out dustbin.

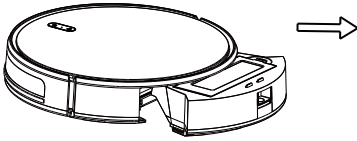

2. Open the dust bin side cover.

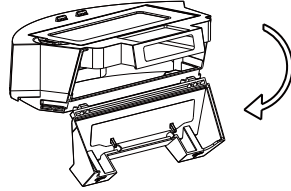

3. Dumping the rubbish.

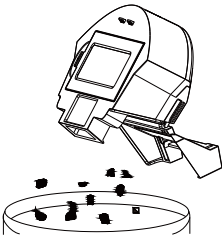

4. Open the HEPA filter cover.

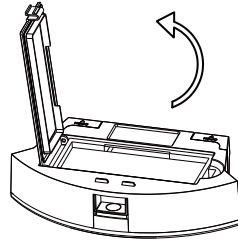

5. Take out of HEPA filter, Sponge Filter and primary filter, clean it by mop or brush. Sponge filter/HEPA filter can't be washed.

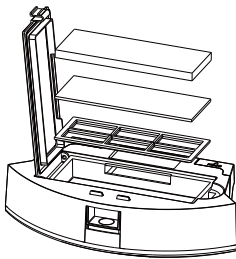

6. Remove the dust from primary filter and wash, dry it before next time use.

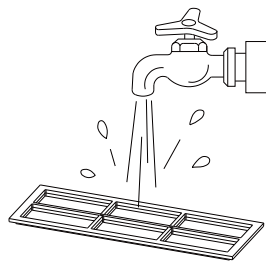

7. Clean the dust bin by mop or cleaning brush.

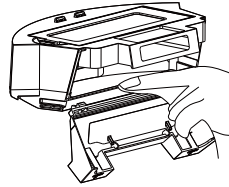

8. Dry the dust bin and filters, keep it dry to extend its lifespan.

Attention: Please wash the primary filter every 15-30days,HEPA filter lifespan is about 3month.

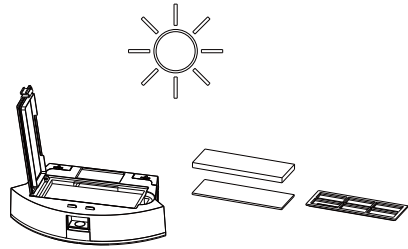

9. Replace the primary filter and the HEPA filter into the dust bin.

Attention: 1、 Before installing the filters, please ensure that the HEPA filter and the primary filter are in dry state.

2、 Do not expose the HEPA filter and primary filter to the sun.

10. Close the dust bin cover and install the dust bin into the host.

Component maintenance/water tank&mop

Water tank is an optional function.

1. take off water tank.

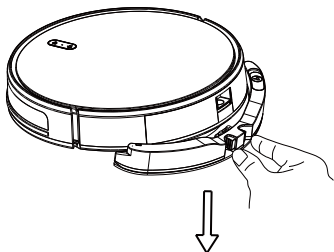

2. take off mop.

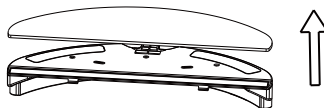

3. Clear the water. (if long time no use)

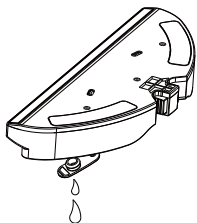

4. Wash the mop.



5. Clean Water tank.

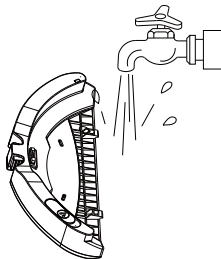

6. Dry the mop.

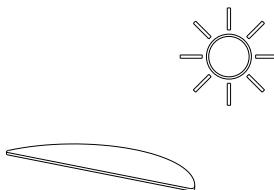

7. Dry the water tank.

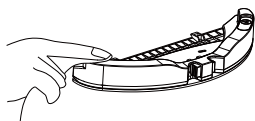

Main Roller Brush

1. Open the roller brush cover.

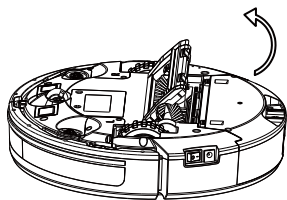

2. Take out the roller brush.

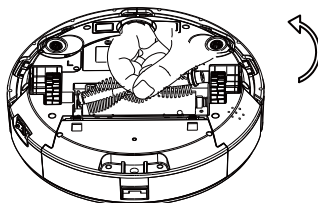

3. Clean the roller brush by cleaning brush.

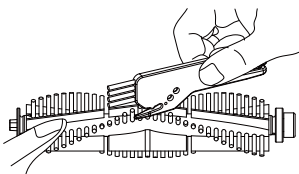

Clean the Side Brush

Take off the side brush, use mop to clean the brush.

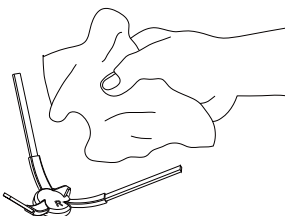

Component maintenance/charging pole pieces&ground sensor&Right/Left wheels&front wheels

Friendly Reminder:

The interior of the charging pole pieces, the ground sensors and the front bumper all contain sensitive electronic components. Please use dry mop to clean the above parts and do not use wet mop to prevent damage caused by water inflow.

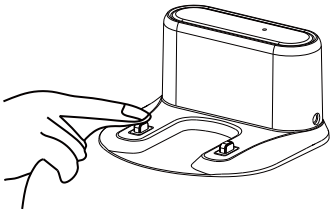

Clean the charge pole pieces

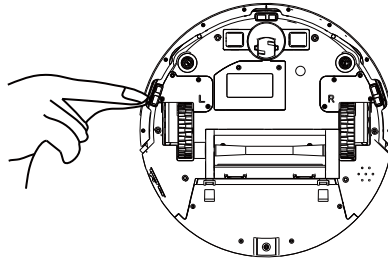

Cleaning the ground sensors

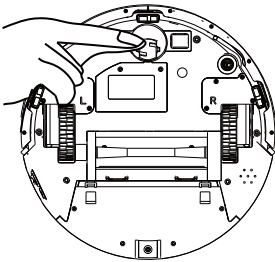

Clean the front wheel

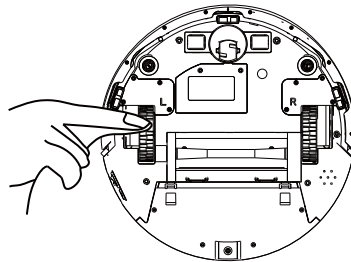

clean the right/left wheel

- * If you do not use the product for a long time, please fully charge it before storing. Turn off the host and keep charging power to it every 3 months to prevent the battery from over discharge.
- * If the battery is over discharged or is not used for a long time, the product may not be able to be charged. Please contact our company for after-sales maintenance. Do not disassemble it by yourself
- * **The product drawings and component drawings in this description are for reference only, and the actual product shall prevail.**

Investigation of Common Problems

Prompt Tone	Cause of Failure	Solution
Robot suspended, stop cleaning	Robot suspended	Please put the robot back to the ground and press the start button
Robot is not yet ready	Press button  when ground or collision detection is effective	Please check whether the front bumper can be bounced normally, and the ground sensors are cleaned
Low battery	Low Battery Reminder when charge base can't be detected	Please charge the robot manually
Low battery, please charge immediately	Low Battery Reminder when charge base can't be detected	Please charge the robot manually
Battery is too low, robot is ready shut down now	Low Battery Reminder when charge base can't be detected	Please charge the robot manually
Charge abnormal, please check	Charging station problem	Please check whether the connection between robot and charging pole pieces connected well, or use adaptor to charge directly
Main roller brush is entangled, please clean it	Roller Brush get tangle	Please check whether the roller brush is twinned and clean up
Left/right wheel jammed, please clean the left/right wheel	Wheel Jammed	Please check whether the wheel is entangled and clean up
Side brush jammed, please clean side brush	Side brush jammed	Please check whether the side brushes is twinned and clean up
please clean side brush check the collision sensor	Front Bumper problem	Please check whether the front bumper can be bounced normally
ground sensor is blocked, please clean ground sensor	Ground sensor problem	Please check whether the sensor get dirtied or be obscured
vacuum motor is entangled, please clean vacuum motor	Vacuum motor jammed	Please check whether the dust bin enter is blocked

If can't troubleshoot according to the above table, you can contact us freely

Product Parameter

The Host

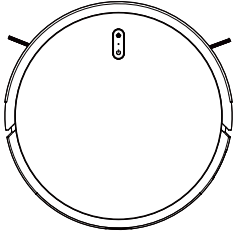

Description	Parameter
Size	320*76mm
Battery	Lithium
Weight	2.3kg
Rated Power	14.8v
Rated Power	22W

Charging Base

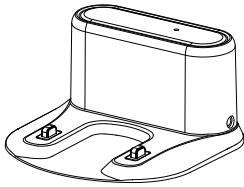

Description	Parameter
Size	155*150*80mm
Input	19V
Output	19V 0.6A
Rated Power	11.4W
Rated Frequency	50/60Hz

Component	Harmful Substances					
	Pb/Pb compound	Hg/Hg compound	Cd/Cd compound	Cr(VI) / Cr(VI) compound	PBB	PBDE
Plastic	○	○	○	○	○	○
Hardware	×	○	○	○	○	○
Host circuit module	×	○	○	○	○	○
Electronic components	○	○	×	○	○	○
Battery	○	○	○	○	○	○
Plug power cord	×	○	○	○	○	○

Description: This form is prepared in accordance with the provisions of SJ/T 11364

○ indicates that the content of the hazardous substance in all homogeneous materials of the part is below the limit requirement specified in the current valid version of GB/T26572.
 × indicates that the content of the hazardous substance in at least one of the homogeneous materials of the part exceeds the limit requirement stipulated in the current effective version of GB/T26572, and there is no mature alternative in the industry, which meets the environmental protection requirements of the EU RoHS Directive.

FCC Statement

This device complies with Part 15 of the FCC Rules. Operation is subject to the following two conditions:

(1) This device may not cause harmful interference.

(2) This device must accept any interference received, including interference that may cause undesired operation.

2. Changes or modifications not expressly approved by the party responsible for compliance could void the user's authority to operate the equipment.

Note: This equipment has been tested and found to comply with the limits for a class B digital device, pursuant to Part 15 of the FCC Rules. These limits are designed to provide reasonable protection against harmful interference in a residential installation.

This equipment generates uses and can radiate radio frequency energy and, if not installed and used in accordance with the instructions, may cause harmful interference to radio communications. However, there is no guarantee that interference will not occur in a particular installation. If this equipment does cause harmful interference to radio or television reception, which can be determined by turning the equipment off and on, the user is encouraged to try to correct the interference by one or more of the following measures:

- Reorient or relocate the receiving antenna.
- Increase the separation between the equipment and receiver.
- Connect the equipment into an outlet on a circuit different from that to which the receiver is connected.
- Consult the dealer or an experienced radio/TV technician for help.

This equipment should be installed and operated with a minimum distance of 20 cm between the radiator and your body.



The number in this logo indicates that the product has an environmental protection period of 10 years under normal use.

Executive standard: GB4706.1-2005 GB4706.7-2014
GB4343.1-2009GB17625.1-2012



" CE "marking states that the product is compliant to European Directives.

2014/35/EU Low Voltage Directive.

2014/30/EU EMC Directive.

It is possible to request a full copy of Declaration of compliance to the Distributor.

This product complies with the rules of RoHS Directive(2011/65/EU&2015/863/EU).

This product complies with the rules of Eup Directive(2009/125/CE).