



FCC Test Report

Report No: FCS202204115W01

Issued for

Applicant:	Haverford Systems, Inc.
Address:	152 Robbins Road, Downingtown, PA 19335, USA
Product Name:	BYOD - Wireless and Wired Content Sharing
Brand Name:	HuddleCamHD
Model Name:	HC-HUDDLESHARE
Series Model:	N/A
FCC ID:	2ATNFHC-HUDDLESHARE
Issued By: Flux Compliance Service Laboratory Add: Room 105 Floor Bao hao Technology Building 1 NO.15 Gong ye West Road Hi-Tech Industrial, Song shan lake Dongguan Tel: 769-27280901 Fax:769-27280901 http://www.fcs-lab.com	



TEST RESULT CERTIFICATION

Applicant's Name: Haverford Systems, Inc.

Address.....: 152 Robbins Road, Downingtown, PA 19335, USA

Manufacture's Name: Grastron Technology CO., LTD

Address.....: 4A Building#B Dingxin Science and Technology Park, Honglangbei #2 Road, Xin'an street, Baoan district, Shenzhen, P.R. China

Product Description

Product Name: BYOD - Wireless and Wired Content Sharing

Model Name.....: HC-HUDDLESHARE

Series Model: N/A

Test Standards: CFR 47 FCC Part15E section 15.407
ANSI C63.10-2013

Test Procedure.....: KDB 789033 D02 General UNII Test procedures New Rules 02
KDB558074 D01 Meas Guidance v05

This device described above has been tested by Flux Compliance Service Laboratory, the test results show that the equipment under test (EUT) is in compliance with the FCC requirements. And it is applicable only to the tested sample identified in the report.
This report shall not be reproduced except in full, without the written approval of Flux Compliance Service Laboratory, this document may be altered or revised by Flux Compliance Service Laboratory, personal only, and shall be noted in the revision of the document..

Date of Test :

Date (s) of performance of tests : 21 Apr, 2022 ~ 31 May, 2022

Date of Issue..... : 31 May, 2022

Test Result : Pass

Tested by : Scott Shen
(Scott Shen)

Reviewed by : Duke Qian
(Duke Qian)

Approved by : Jack Wang
(Jack Wang)



Table of Contents	Page
1. SUMMARY OF TEST RESULTS	6
1.1 TEST FACTORY	7
1.2 MEASUREMENT UNCERTAINTY	7
2. GENERAL INFORMATION	8
2.1 GENERAL DESCRIPTION OF THE EUT	8
2.2 BLOCK DIGRAM SHOWING THE CONFIGURATION OF SYSTEM TESTED	10
2.3 DESCRIPTION OF NECESSARY ACCESSORIES AND SUPPORT UNITS	12
2.4 EQUIPMENTS LIST	13
3. 26DB BANDWIDTH, 6DB BANDWIDTH AND 99% BANDWIDTH	14
3.1 LIMIT	14
3.2 TEST PROCEDURE	14
3.3 TEST SETUP	14
3.4 TEST RESULTS	15
4 CONDUCTED OUTPUT POWER	38
4.1 LIMIT	38
4.2 TEST PROCEDURE	38
4.3 TEST SETUP	38
4.4 TEST RESULTS	39
5. POWER SPECTRAL DENSITY	40
5.1 LIMIT	40
5.2 TEST PROCEDURE	40
5.3 TEST SETUP	41
5.4 TEST RESULTS	41
5.5 ORIGINAL TEST DATA	42
6. FREQUENCY STABILITY MEASUREMENT	56
6.1 LIMIT	56
6.2 TEST PROCEDURE	56
6.3 TEST SETUP	56
6.4 TEST RESULTS	57



Table of Contents	Page
	57
7. BAND EDGE	58
7.1 LIMIT	58
7.3 TEST SETUP	59
7.5 TEST RESULTS	60
7.5 ORIGINAL TEST DATA	60
8. DUTY CYCLE	72
8.1 TEST REQUIREMENT	72
8.2 TEST PROCEDURE	72
7.3 TEST SETUP	72
8.4 TEST RESULTS	73
9 RADIATED EMISSION MEASUREMENT	74
10 CONDUCTED EMISSION TEST	82
11. ANTENNA REQUIREMENT	86
11.1 STANDARD REQUIREMENT	86
11.2 RESULT	86



Revision History

Rev.	Issue Date	Report NO.	Effect Page	Contents
00	31 May, 2022	FCS202204115W01	ALL	Initial Issue



1. SUMMARY OF TEST RESULTS

Test procedures according to the technical standards:

Standard Section	Test Item	Judgment	Remark
FCC 15.407 (e)	6/26db Bandwidth and 99% Bandwidth	PASS	--
FCC 15.407 (a)	Maximum Conducted Output Power	PASS	--
FCC 15.407 (a)	Power Spectral Density	PASS	--
FCC 15.407 (g)	Frequency Stability Measurement	PASS	
FCC 15.407 (a) FCC 15.209 FCC 15.205	Emissions in restricted frequency bands	PASS	
FCC 15.407 (a) FCC 15.209 FCC 15.205	Band Edge Compliance	PASS	
FCC 15.207	Power Line Conducted Emission	PASS	
FCC 15.203	Antenna requirement	PASS	--



1.1 TEST FACTORY

Company Name:	Flux Compliance Service Laboratory
Address:	Room 105 Floor Bao hao Technology Building 1 NO.15 Gong ye West Road Hi-Tech Industrial, Song shan lake Dongguan
Telephone:	+86-769-27280901
Fax:	+86-769-27280901
FCC Test Firm Registration Number: 514908 Designation number: CN0127 A2LA accreditation number: 5545.01	

1.2 MEASUREMENT UNCERTAINTY

The reported uncertainty of measurement $y \pm U$, where expanded uncertainty U is based on a standard uncertainty multiplied by a coverage factor of $k=2$, providing a level of confidence of approximately **95** %.

No.	Item	Uncertainty
1	RF output power, conducted	± 0.71 dB
2	Unwanted Emissions, conducted	± 2.988 dB
3	Conducted Emission (9KHz-150KHz)	± 4.13 dB
4	Conducted Emission (150KHz-30MHz)	± 4.74 dB
5	All emissions, radiated (<1G) 9KHz-30MHz	± 5.2 dB
6	All emissions, radiated (<1G) 30MHz-1000MHz	± 5.2 dB
7	All emissions, radiated 1GHz -18GHz	± 4.66 dB
8	All emissions, radiated 18GHz -40GHz	± 4.31 dB



2. GENERAL INFORMATION

2.1 GENERAL DESCRIPTION OF THE EUT

Product Name	BYOD - Wireless and Wired Content Sharing
Trade Name	HuddleCamHD
Model Name	HC-HUDDLESHARE
Series Model	N/A
Model Difference	NA
Channel List	Please refer to the Note 2.2.
Operation frequency	IEEE 802.11a/n/ac(HT20): U-NII-1 5150MHz ~5250MHZ U-NII-3 5725MHZ-5850 MHz
Number of channel	5150MHz ~5250MHZ (7CH) 5725MHZ-5850 MHz (8CH)
Modulation:	OFDM
Power supply	DC 5V by adapter
Battery	N/A
Hardware version number	V1.0
Software version number	V1.0
Sample type	Portable equipment
Connecting I/O Port(s)	Please refer to the User's Manual

Note:

1. For a more detailed features description, please refer to the manufacturer's specifications or the User's Manual.

2.

U-NII-1 (5.15-5.25GHz)			
channel	Frequency(MHz)	channel	Frequency(MHz)
36	5180	38	5190
40	5200	42	5210
44	5220	46	5230
48	5240		

U-NII-3 (5.725-5.85GHz)			
channel	Frequency(MHz)	channel	Frequency(MHz)
149	5745	151	5755
153	5765	155	5775
157	5785	159	5795
161	5805	165	5825

3. Table for Filed Antenna

Ant.	Brand	Model Name	Antenna Type	Connector	Gain (dBi)	NOTE
1	N/A	KCC	external antenna	N/A	1.0B dBi	WIFI Antenna 1
2	N/A	KCC	external antenna	N/A	1.0B dBi	WIFI Antenna 2

2.2 BLOCK DIGRAM SHOWING THE CONFIGURATION OF SYSTEM TESTED

During testing channel & power controlling software provided by the customer was used to control the operating channel as well as the output power level. The RF output power selection is for the setting of RF output power expected by the customer and is going to be fixed on the firmware of the final end product.

Block diagram of EUT configuration for test

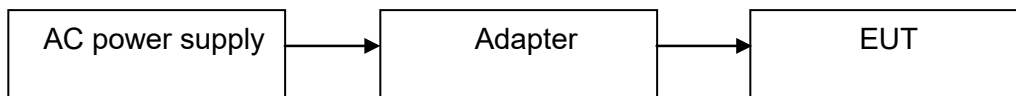

Test software: the QA tool

The test software was used to control EUT work in continuous TX mode, and select test channel, Wireless mode as below table

For 802.11a/n/ac(HT20)

U-NII-1

channel	Frequency(MHz)	channel	Frequency(MHz)
36	5180	40	5200
48	5240		

U-NII-3

channel	Frequency(MHz)	channel	Frequency(MHz)
149	5745	157	5785
165	5825		

For 802.11n/ac(HT40)

U-NII-1

channel	Frequency(MHz)	channel	Frequency(MHz)
38	5190	46	5230

U-NII-3

channel	Frequency(MHz)	channel	Frequency(MHz)
151	5755	159	5795



For 802.11ac(HT80)

U-NII-1

channel	Frequency(MHz)	channel	Frequency(MHz)
42	5210		

U-NII-3

channel	Frequency(MHz)	channel	Frequency(MHz)
155	5775		



2.3 DESCRIPTION OF NECESSARY ACCESSORIES AND SUPPORT UNITS

The EUT has been tested as an independent unit together with other necessary accessories or support units. The following support units or accessories were used to form a representative test configuration during the tests.

Necessary accessories

Item	Equipment	Mfr/Brand	Model/Type No.	Serial No.	Note

Support units

Item	Equipment	Mfr/Brand	Model/Type No.	Serial No.	Note

Note:

- (1) The support equipment was authorized by Declaration of Confirmation.
- (2) For detachable type I/O cable should be specified the length in cm in 『Length』 column.
- (3) “YES” is means “shielded” “with core”; “NO” is means “unshielded” “without core”.

2.4 EQUIPMENTS LIST

Radiation Test equipment

Kind of Equipment	Manufacturer	Type No.	Company No.	Last calibration	Calibrated until
EMI Test Receiver	R&S	ESRP 3	FCS-E001	2022.02.10	2023.02.09
Signal Analyzer	R&S	FSV40-N	FCS-E012	2022.02.10	2023.02.09
Active loop Antenna	ZHINAN	ZN30900C	FCS-E013	2022.02.10	2023.02.09
Bilog Antenna	SCHWARZBECK	VULB 9168	FCS-E002	2022.02.10	2023.02.09
Horn Antenna	SCHWARZBECK	BBHA 9120D	FCS-E003	2022.02.10	2023.02.09
SHF-EHF Horn Antenna (18G-40GHz)	A-INFO	LB-180400-KF	FCS-E018	2022.02.10	2023.02.09
Pre-Amplifier(0.1M-3G Hz)	EMCI	EM330N	FCS-E004	2022.02.10	2023.02.09
Pre-Amplifier (1G-18GHz)	N/A	TSAMP-0518SE	FCS-E014	2022.02.10	2023.02.09
Pre-Amplifier (18G-40GHz)	TERA-MW	TRLA-0400	FCS-E019	2022.02.10	2023.02.09
Temperature & Humidity	HTC-1	victor	FCS-E005	2022.02.10	2023.02.09

Conduction Test equipment

Kind of Equipment	Manufacturer	Type No.	Company No.	Last calibration	Calibrated until
EMI Test Receiver	R&S	ESCI	FCS-E020	2022.02.10	2023.02.09
LISN	R&S	ENV216	FCS-E007	2022.02.10	2023.02.09
LISN	ETS	3810/2NM	FCS-E009	2022.02.10	2023.02.09
Temperature & Humidity	HTC-1	victor	FCS-E008	2022.02.10	2023.02.09

RF Connected Test

Kind of Equipment	Manufacturer	Type No.	Company No.	Last calibration	Calibrated until
MXA SIGNAL Analyzer	Keysight	N9020A	FCS-E015	2022.02.10	2023.02.09
Spectrum Analyzer	Agilent	E4447A	MY50180039	2022.02.10	2023.02.09
Spectrum Analyzer	R&S	FSV-40	101499	2022.02.10	2023.02.09

3. 26dB Bandwidth, 6dB Bandwidth and 99% Bandwidth

3.1 Limit

FCC Part15, Subpart E		
Test Item	Limit	Frequency Range (MHz)
Bandwidth	26 dB Bandwidth	5150-5250
	26 dB Bandwidth	5250-5350
	26 dB Bandwidth	For FCC:5470-5725 For IC:5470-5600 5650-5725
	Minimum 500kHz 6dB Bandwidth	5725-5850

3.2 Test Procedure

(1) Connect EUT's antenna output to spectrum analyzer by RF cable.

Center Frequency	The centre frequency of the channel under test
Detector	Peak
RBW	For 6dB Bandwidth: RBW=100kHz For 26dB Bandwidth: approximately 1% of the emission bandwidth.
VBW	For 6dB Bandwidth: VBW=300kHz For 26dB Bandwidth: >3RBW
Trace	Max hold
Sweep	Auto couple

(2) Allow the trace to stabilize, measure the maximum width of the emission that is constrained by the frequencies associated with the two outermost amplitude points (upper and lower frequencies) that are attenuated by 26dB and 6dB relative to the maximum level measured in the fundamental emission.

3.3 Test setup



3.4 Test results

Band	Operation mode	26 dB Bandwidth (MHz)			99% Bandwidth (MHz)		
		Low	Middle	High	Low	Middle	High
U-NII-1	802.11a	20.28	20.71	20.63	16.543	16.552	16.546
	802.11n(HT20)	20.35	20.50	20.37	17.613	17.605	17.624
	802.11n(HT40)	43.50	/	50.48	36.263	/	36.334
	802.11ac(HT20)	20.51	20.49	20.29	17.607	17.611	17.646
	802.11ac(HT40)	43.16	/	50.69	36.256	/	36.339
	802.11ac(HT80)	81.77	/	/	75.884	/	/

Band	Operation mode	6 dB Bandwidth (MHz)		
		Low	Middle	High
U-NII-3	802.11a	17.01	17.26	17..51
	802.11n(HT20)	17.00	17.05	17.17
	802.11n(HT40)	35.60	/	35.63
	802.11ac(HT20)	17.35	17.05	16.96
	802.11ac(HT40)	35.61	/	35.75
	802.11ac(HT80)	75.38	/	/

3.5 Original Test Data

U-NII-1 11a Low CH 5180MHZ

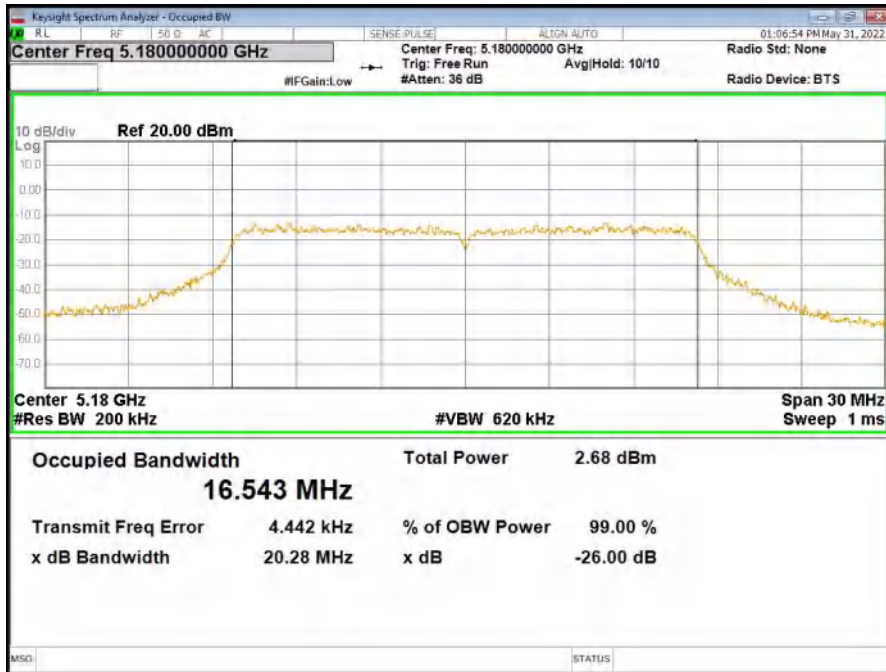

U-NII-1 11a Middle CH 5200MHZ

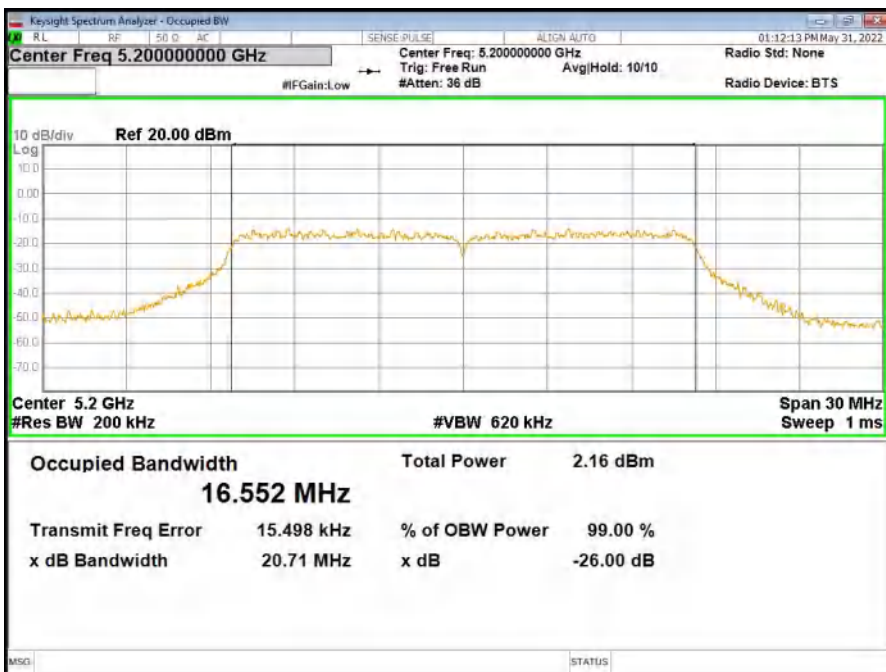

U-NII-1 11a High CH 5240MHZ

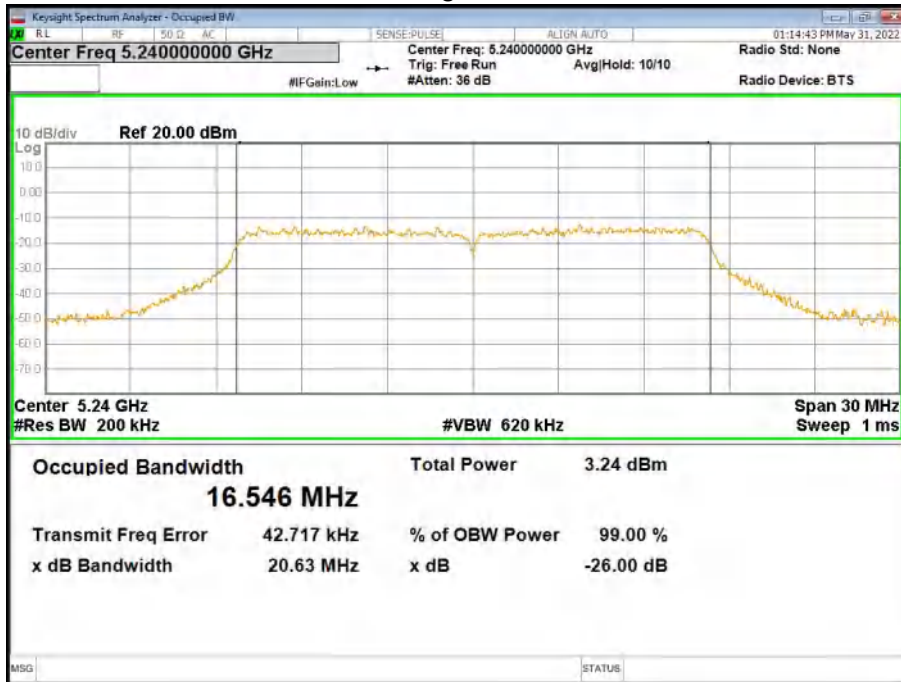

U-NII-1 11n(HT20) Low CH 5180MHZ

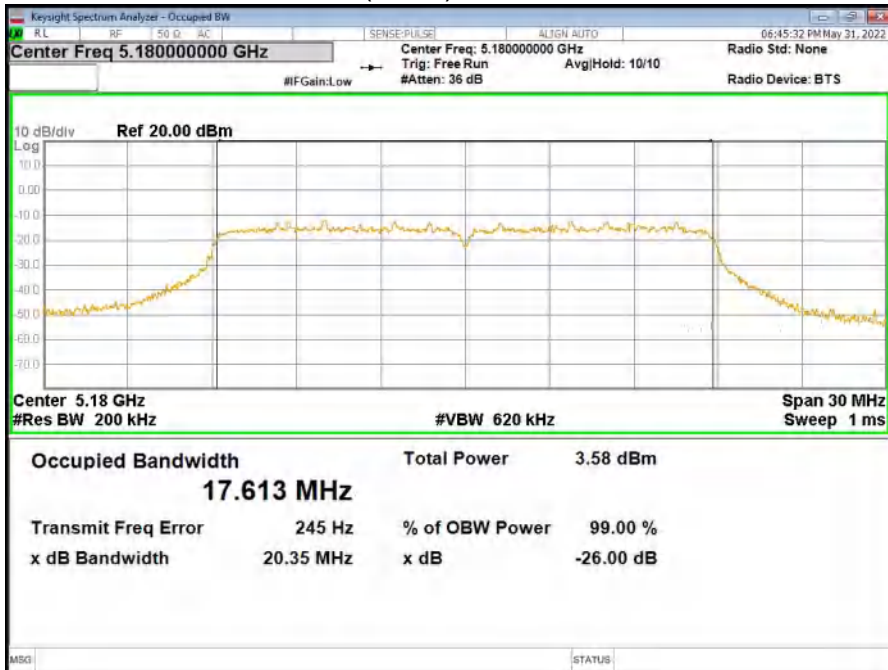



U-NII-1 11n(HT20) Middle CH 5200MHZ

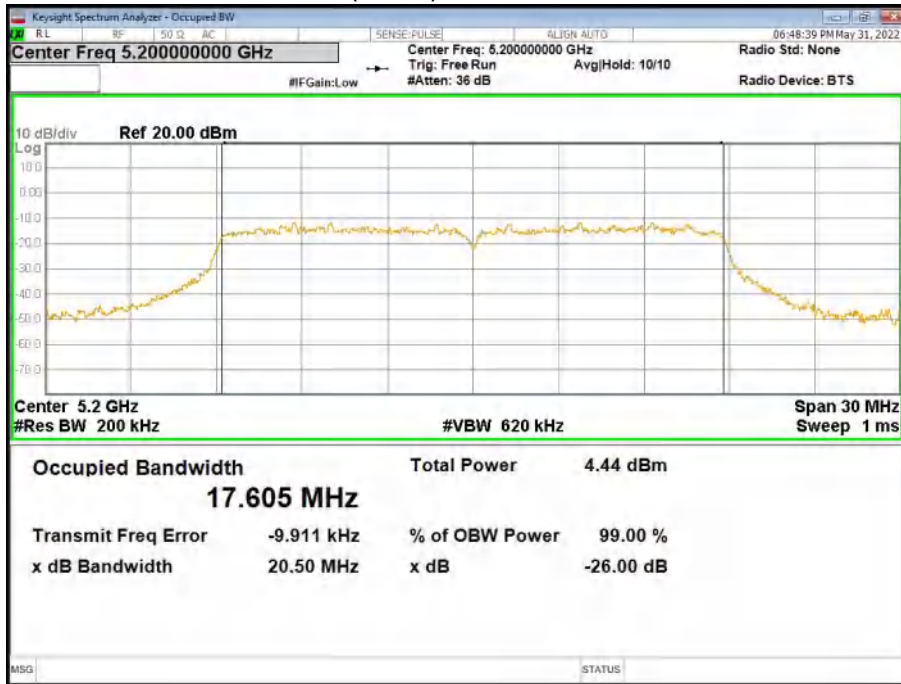

U-NII-1 11n(HT20)High CH 5240MHZ

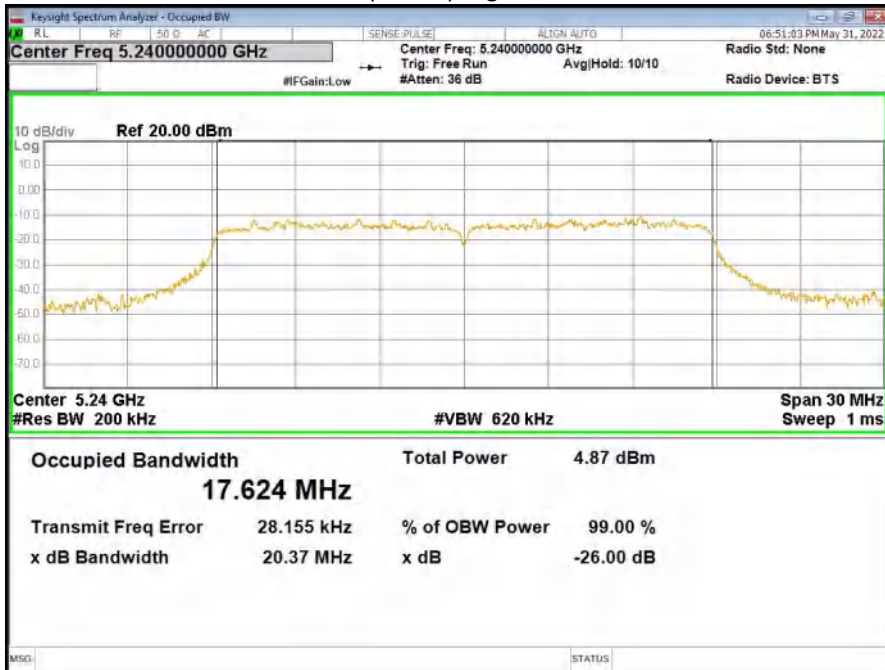

U-NII-1 11n(HT40) Low CH 5190MHZ

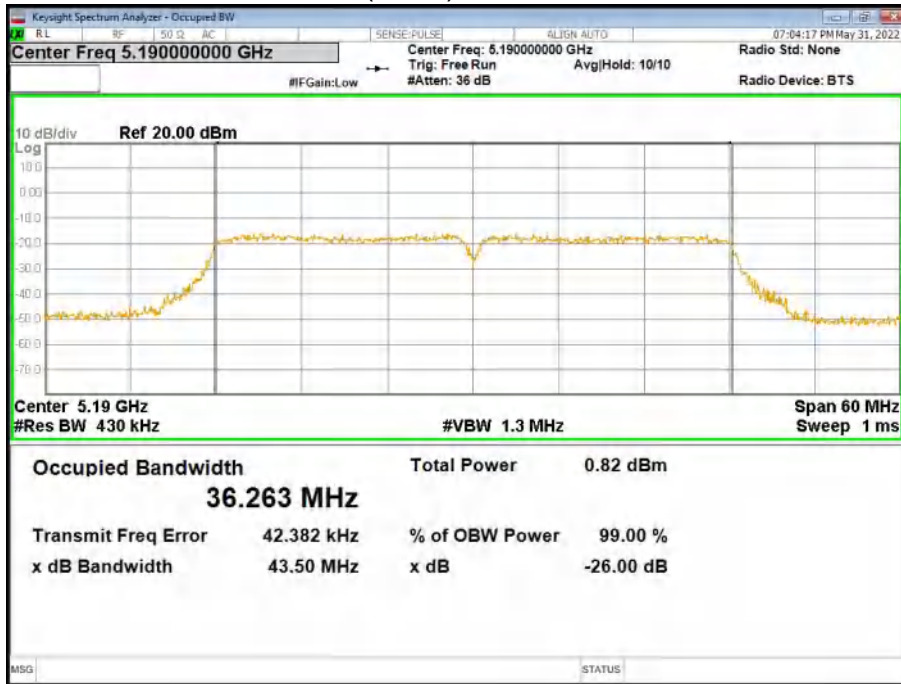

U-NII-1 11n(HT40) High CH 5230MHZ

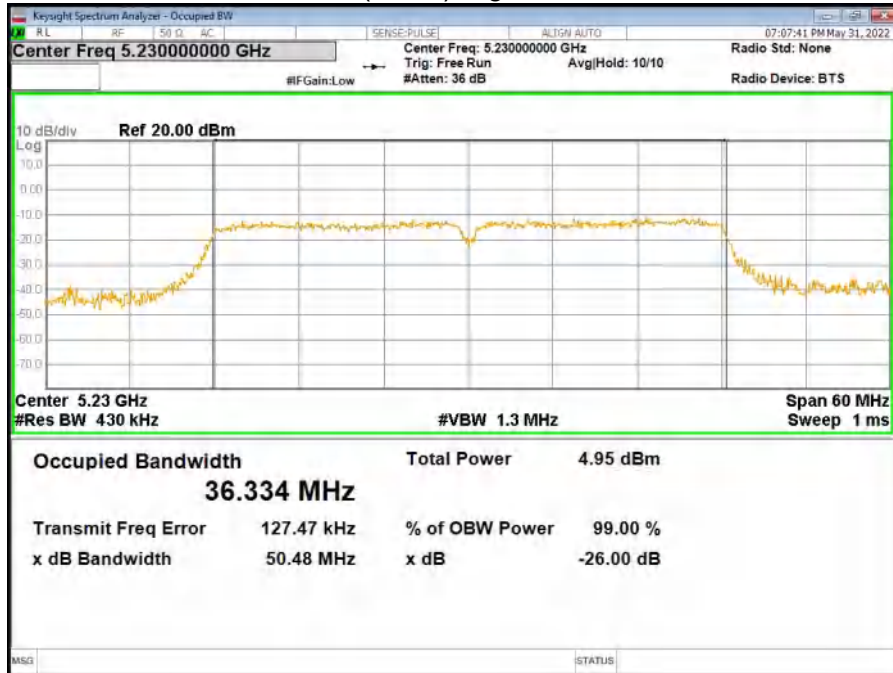



U-NII-1 ac(HT20) Low CH 5180MHZ

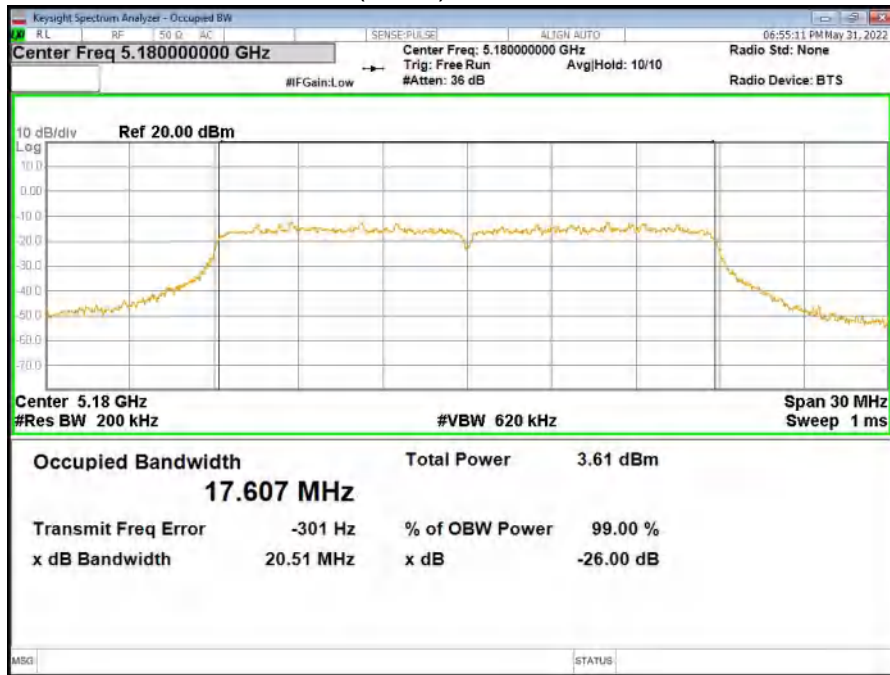



U-NII-1 ac(HT20) Middle CH 5200MHZ

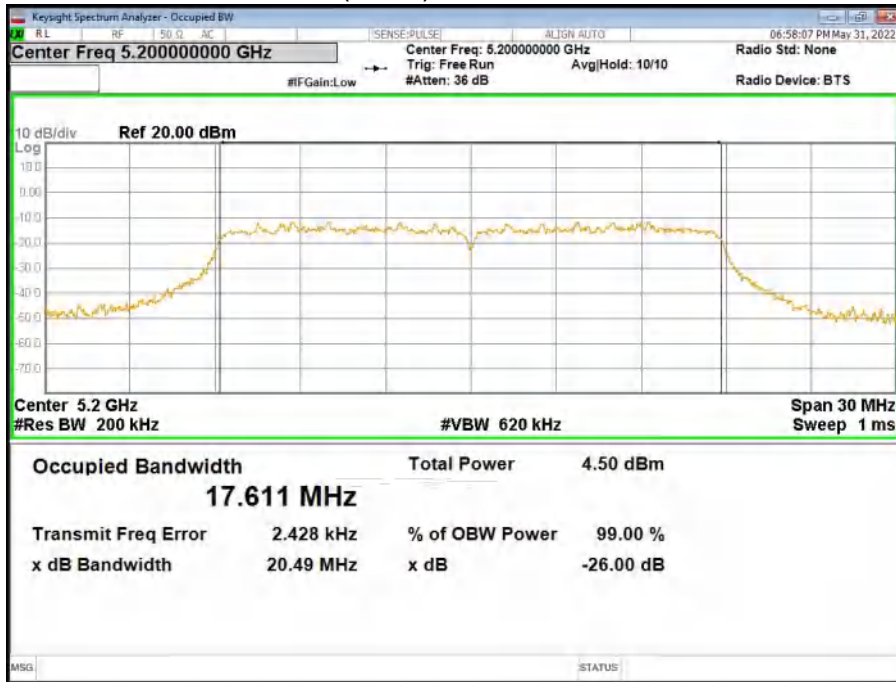

U-NII-1 ac(HT20)High CH 5240MHZ

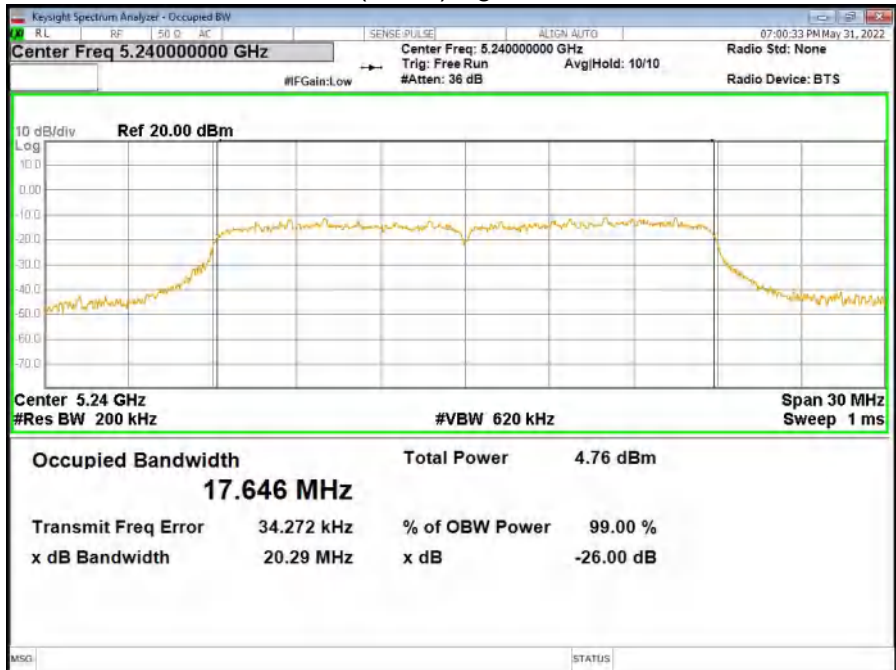

U-NII-1 ac(HT40) Low CH 5190MHz

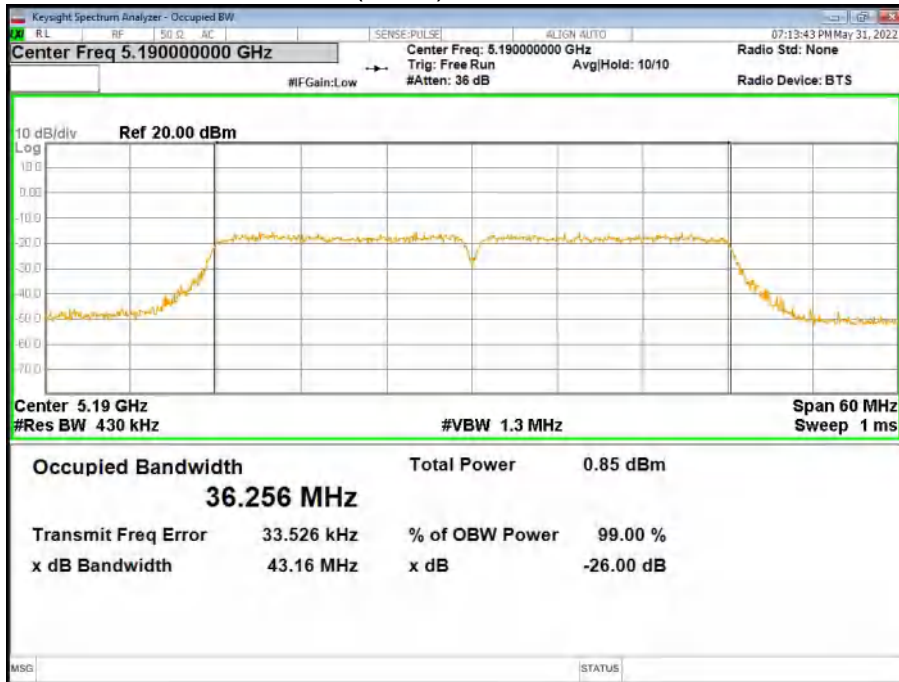

U-NII-1 ac(HT40) High CH 5230MHz

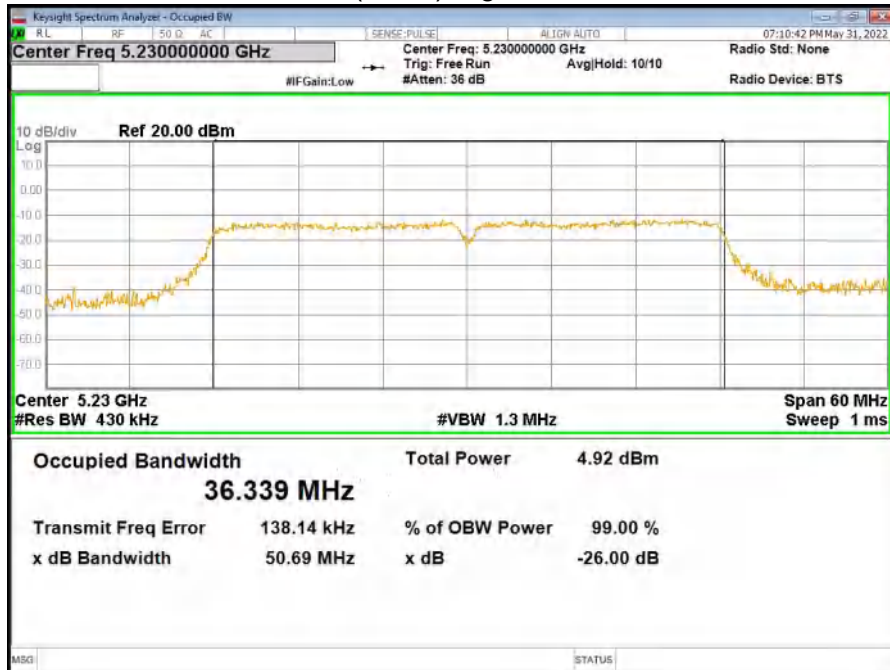

U-NII-1 ac(HT80) Low CH 5210MHZ

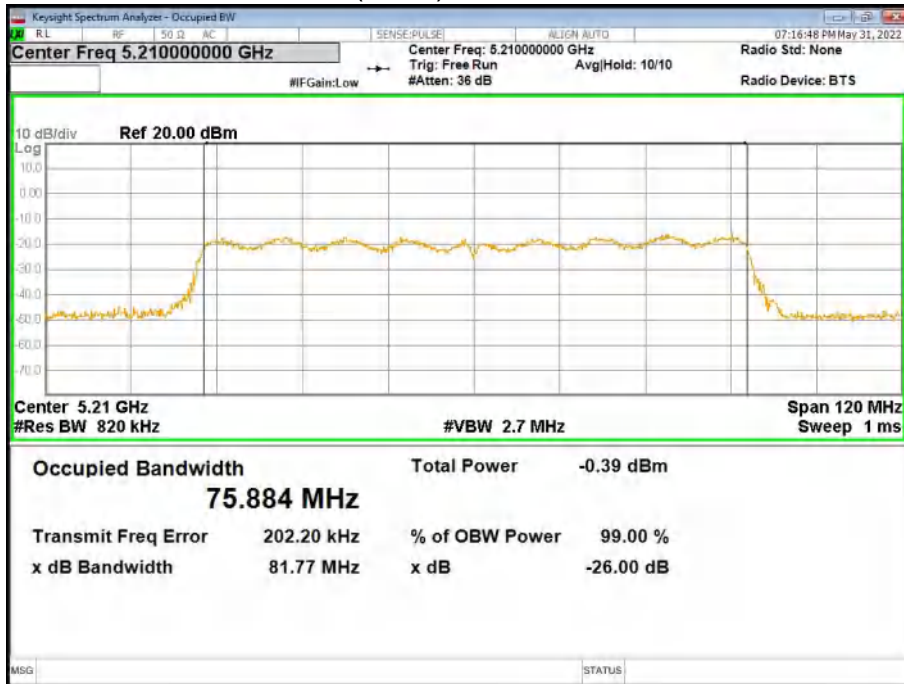

U-NII-3 11a Low CH 5745MHZ

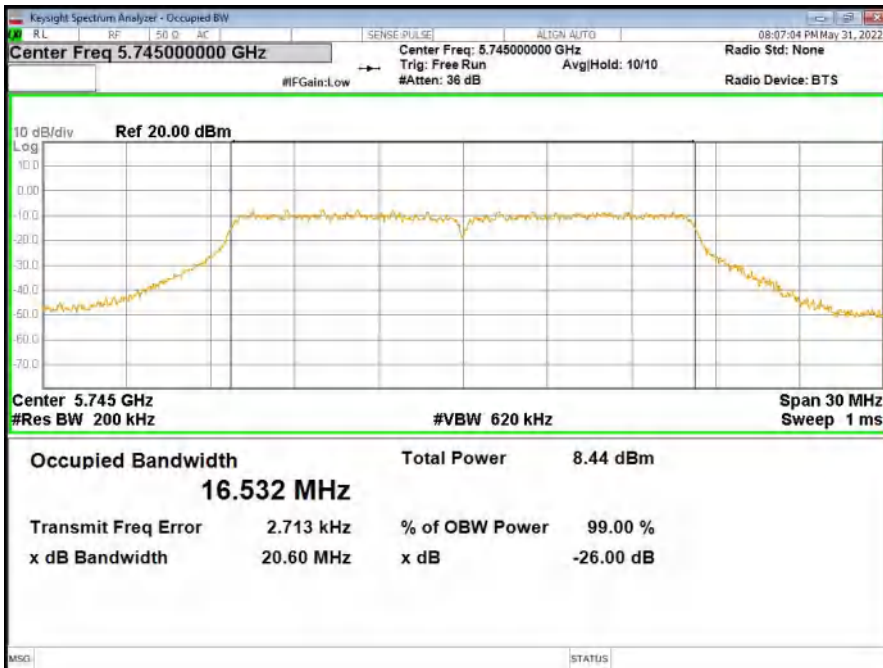



U-NII-3 11a Middle CH 5785MHZ

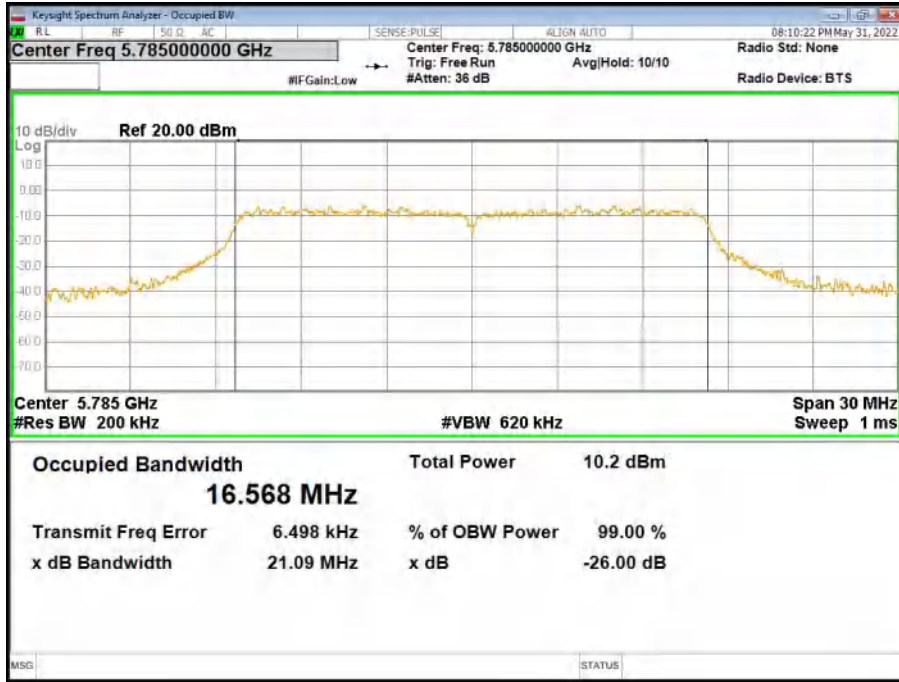

U-NII-3 11a High CH 5825MHZ

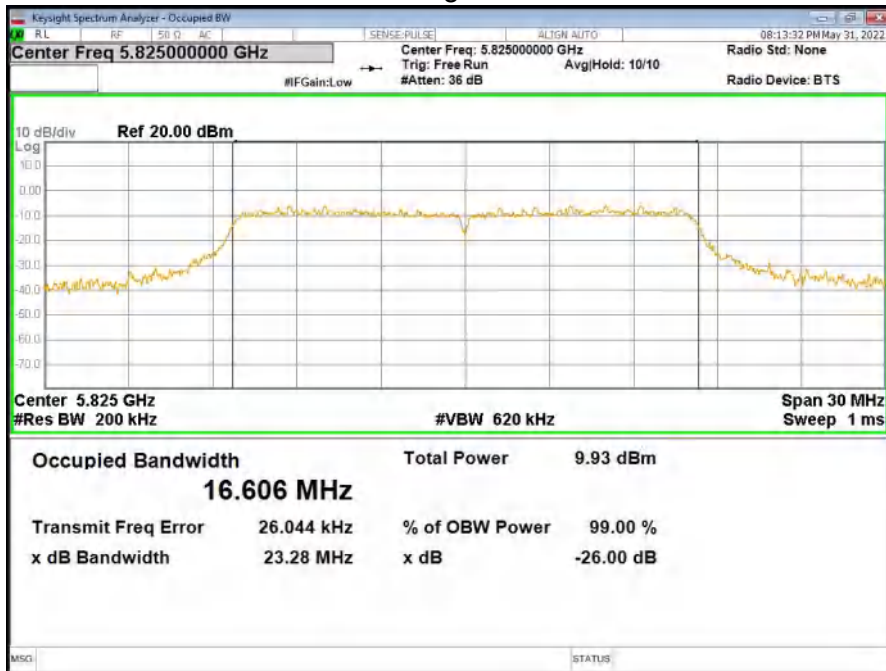



U-NII-3 11n(HT 20) Low CH 5745MHZ

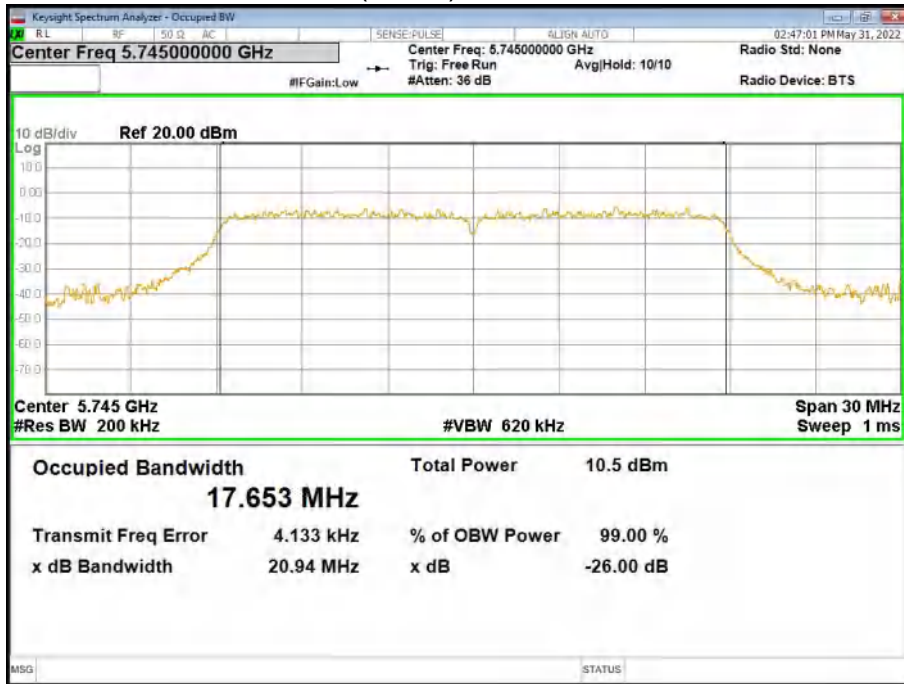

U-NII-3 11n(HT 20) Middle CH 5785MHZ

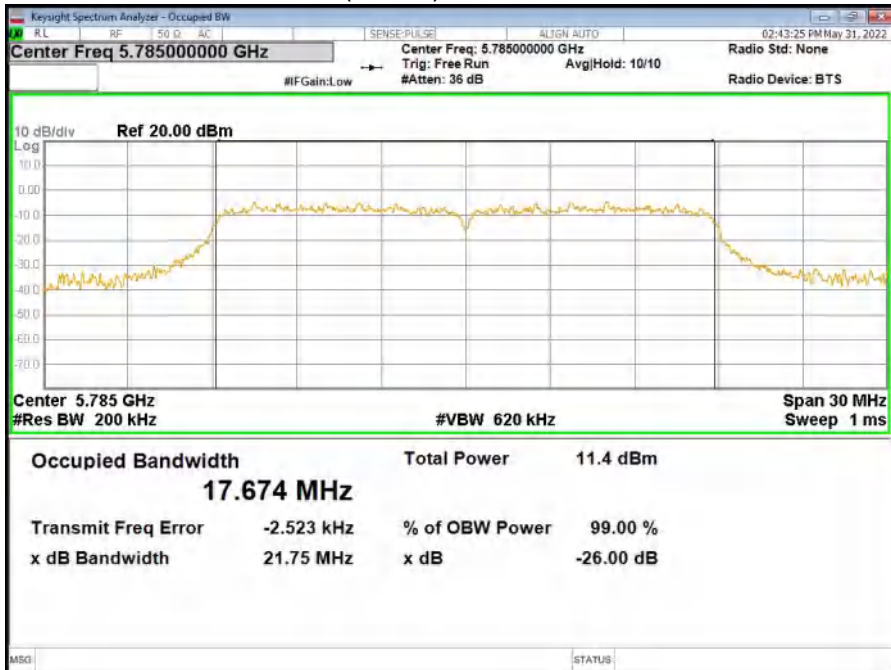



U-NII-3 11n(HT 20) High CH 5825MHZ

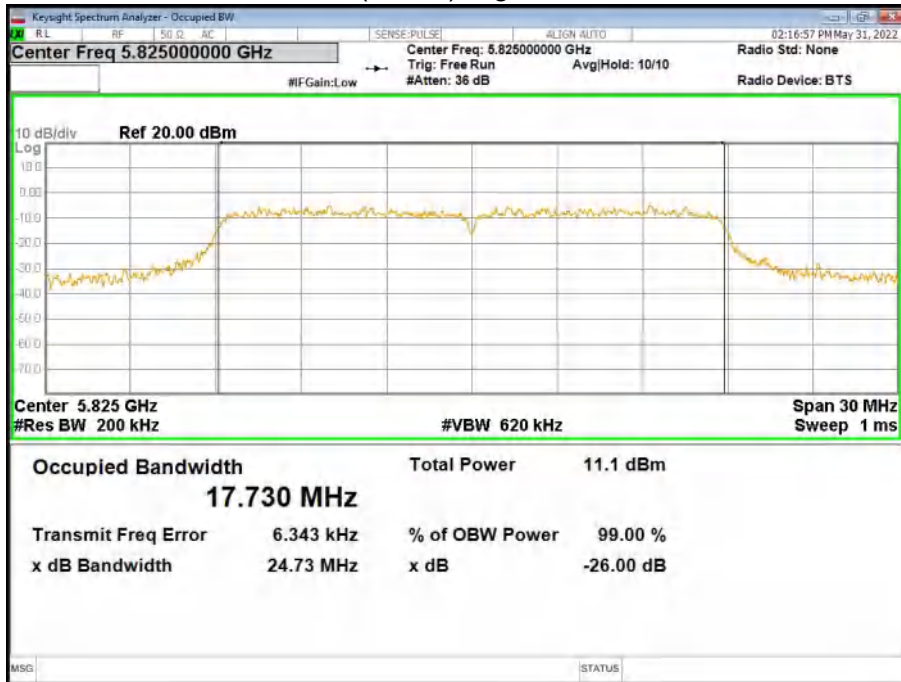

U-NII-3 11n(HT 40) Low CH 5755MHZ

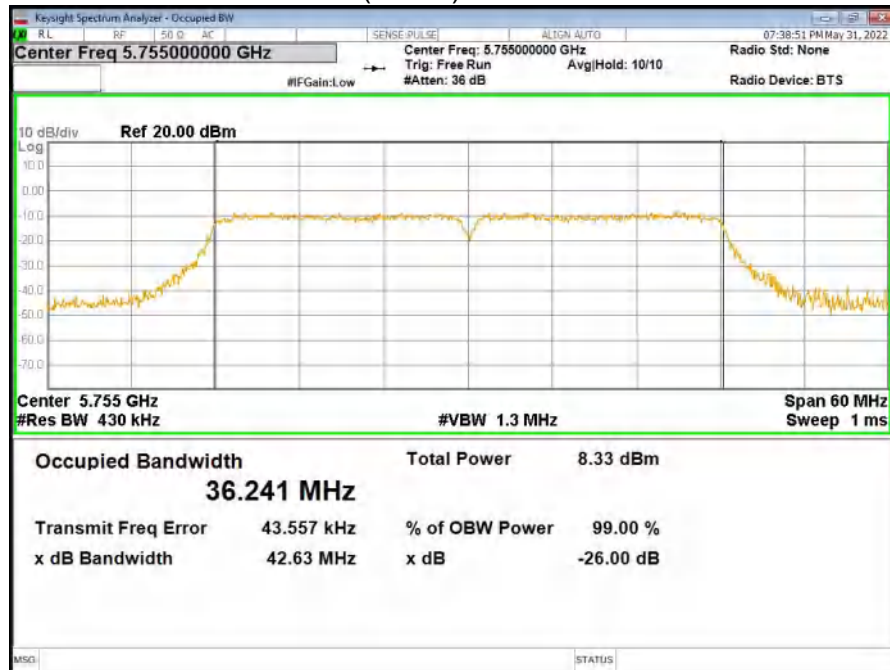

U-NII-3 11n(HT 40) High CH 5795MHZ

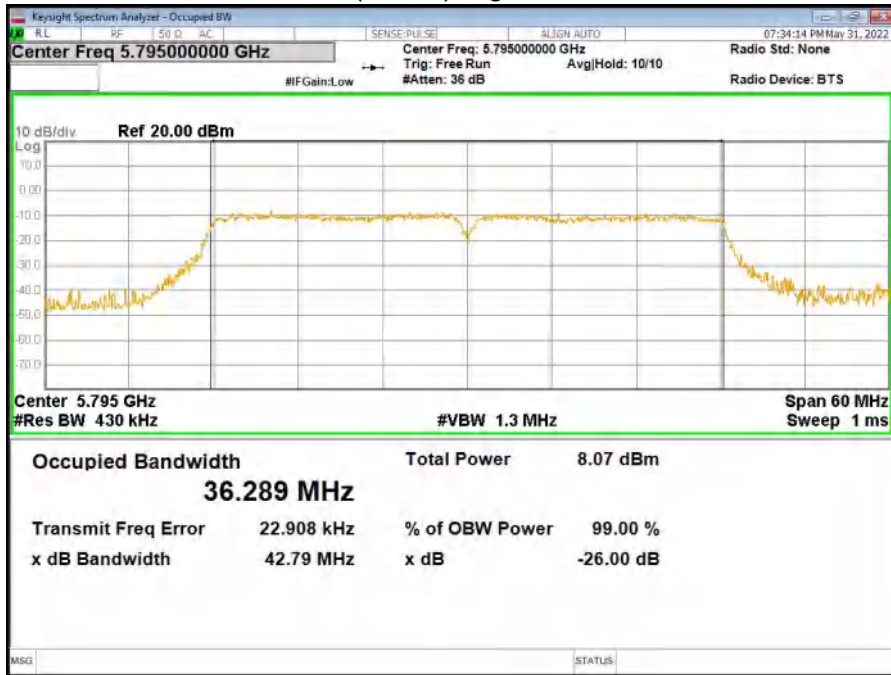

U-NII-3 ac(HT20) Low CH 5745MHZ

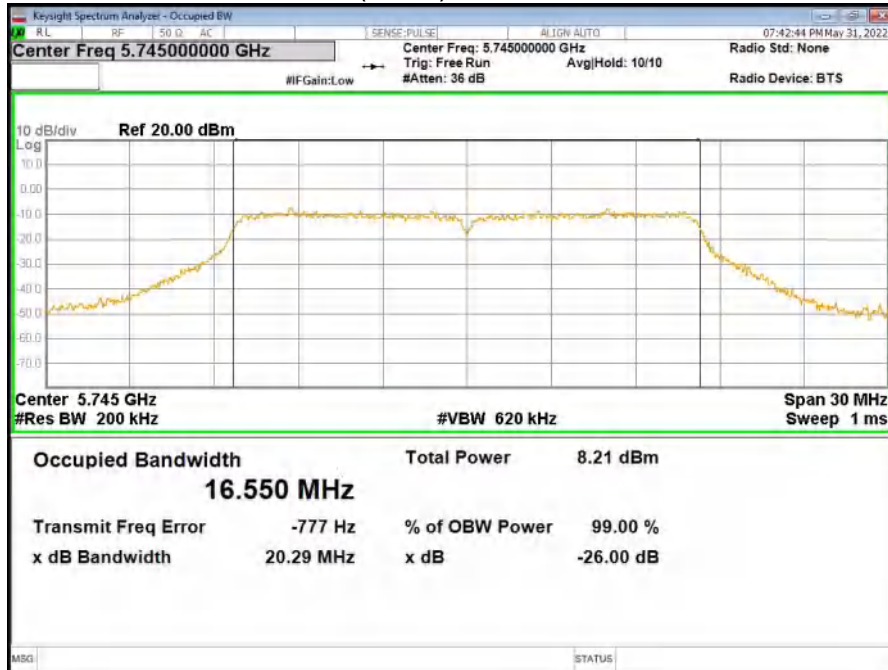



U-NII-3 ac(HT20) Middle CH 5785MHZ

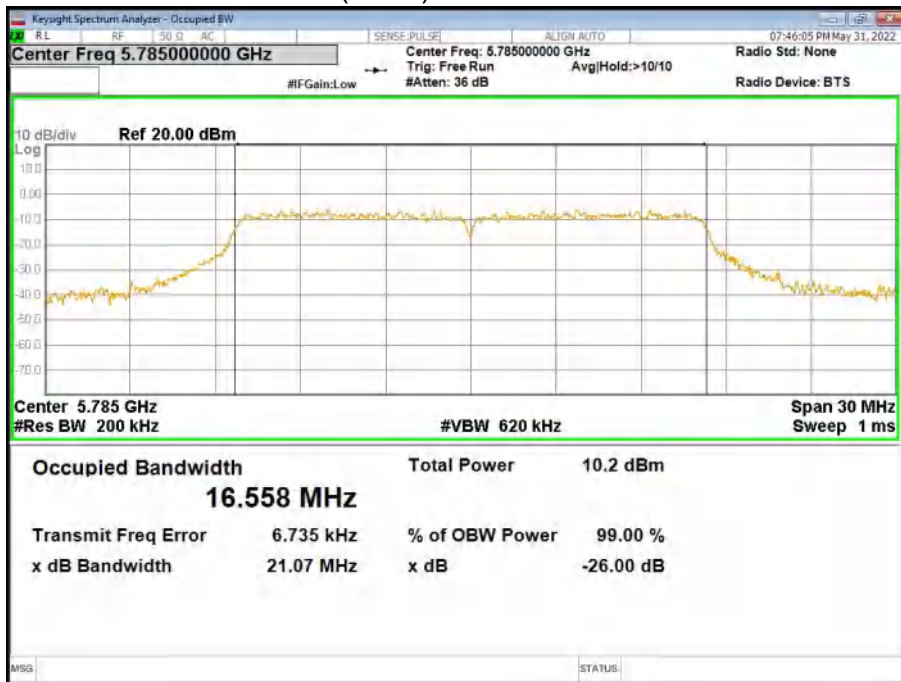

U-NII-3 ac(HT20) High CH 5825MHZ

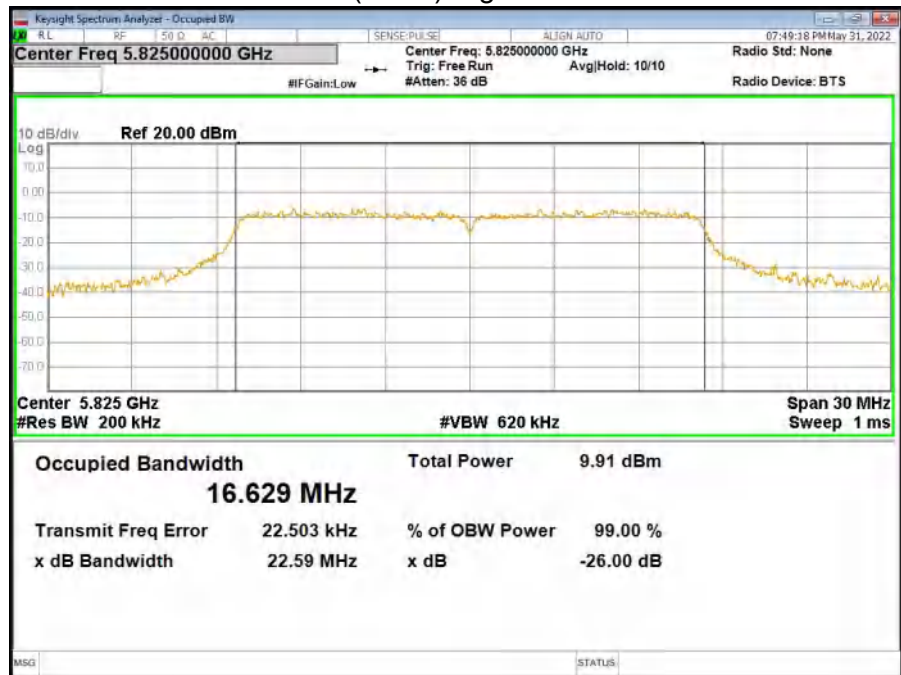



U-NII-3 ac(HT40) Low CH 5755MHZ

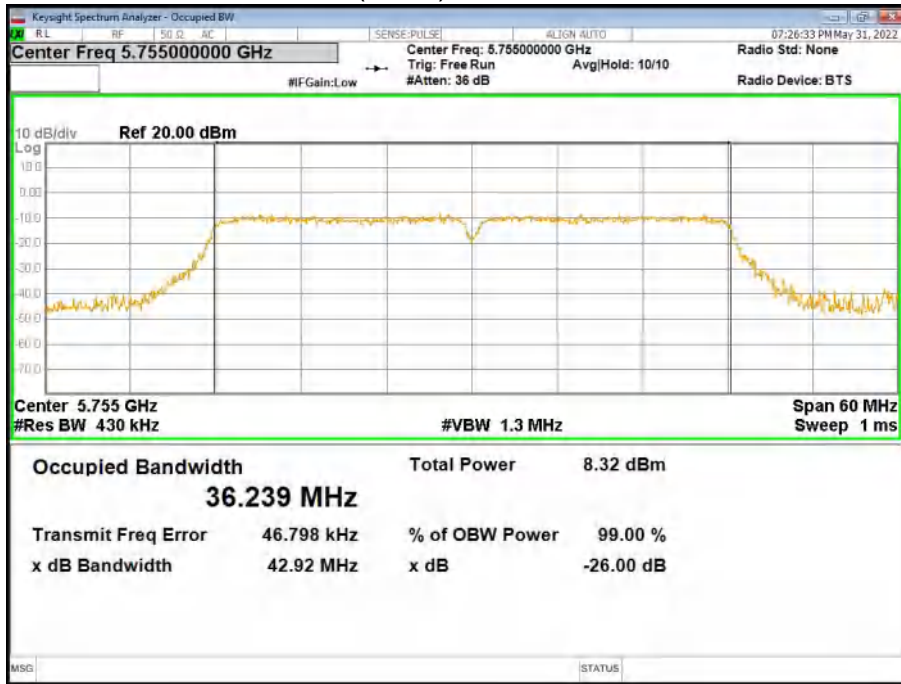

U-NII-3 ac(HT40) High CH 5795MHZ

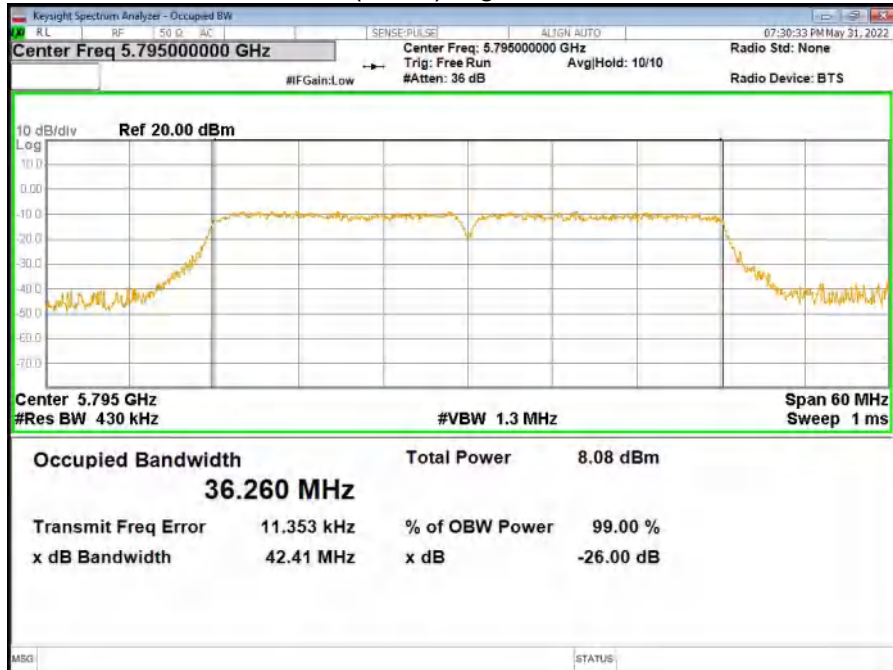



U-NII-3 ac(HT80) Low CH 5775MHZ

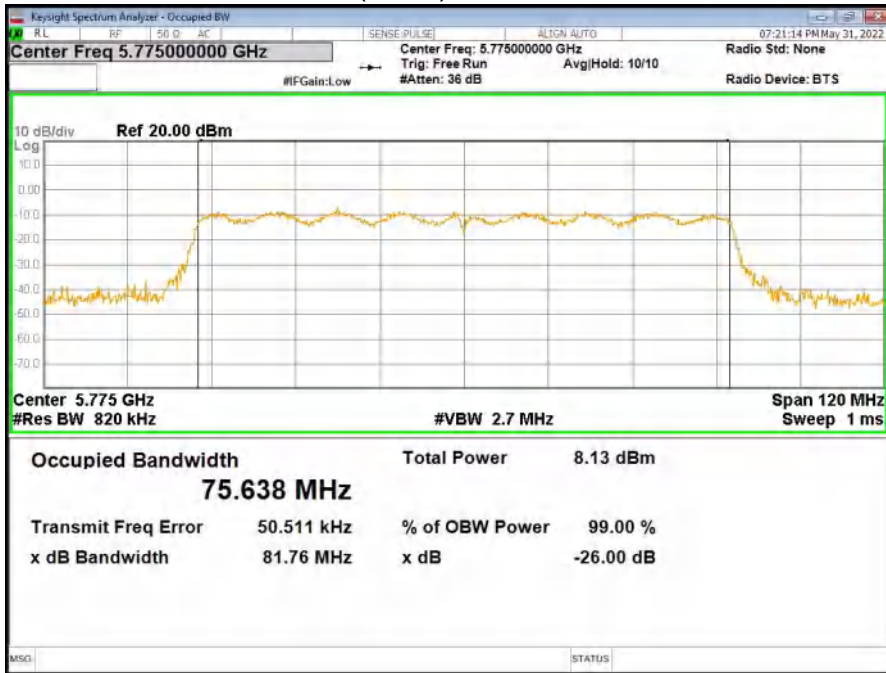



6dB Bandwidth test result

U-NII-3 11a Low CH 5745MHZ

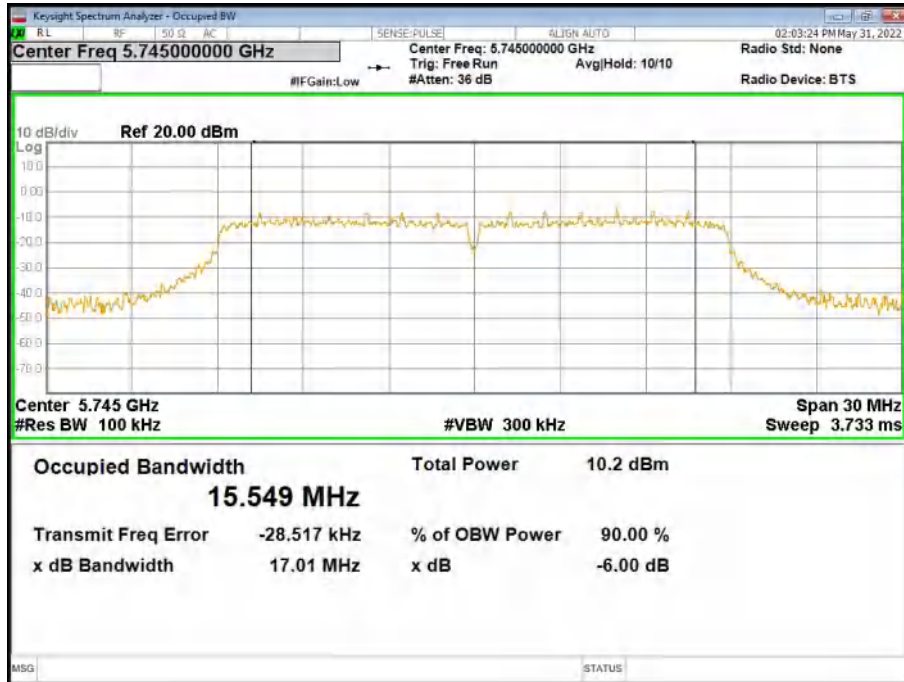

U-NII-3 11a Middle CH 5785MHZ

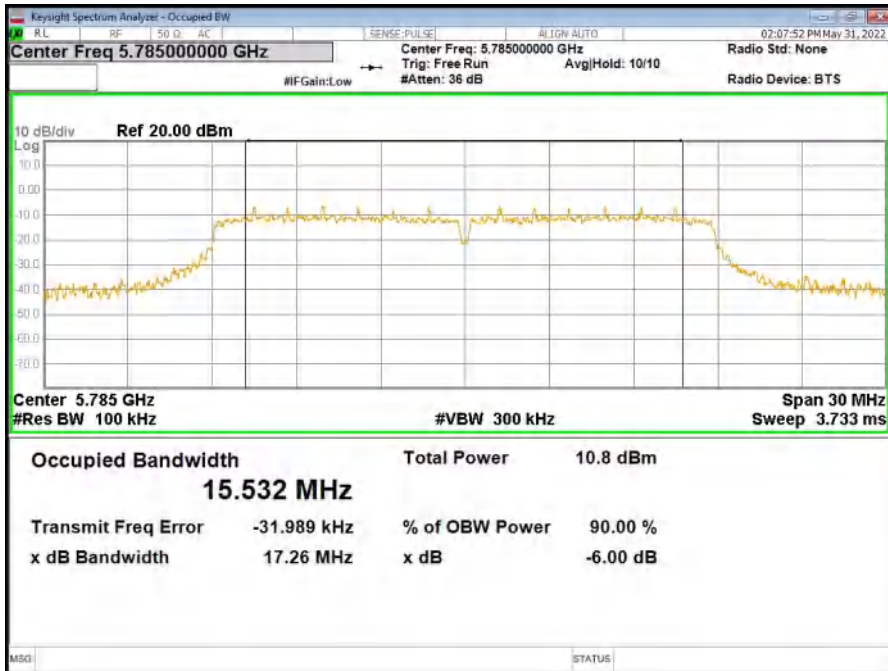



U-NII-3 11a High CH 5825MHZ

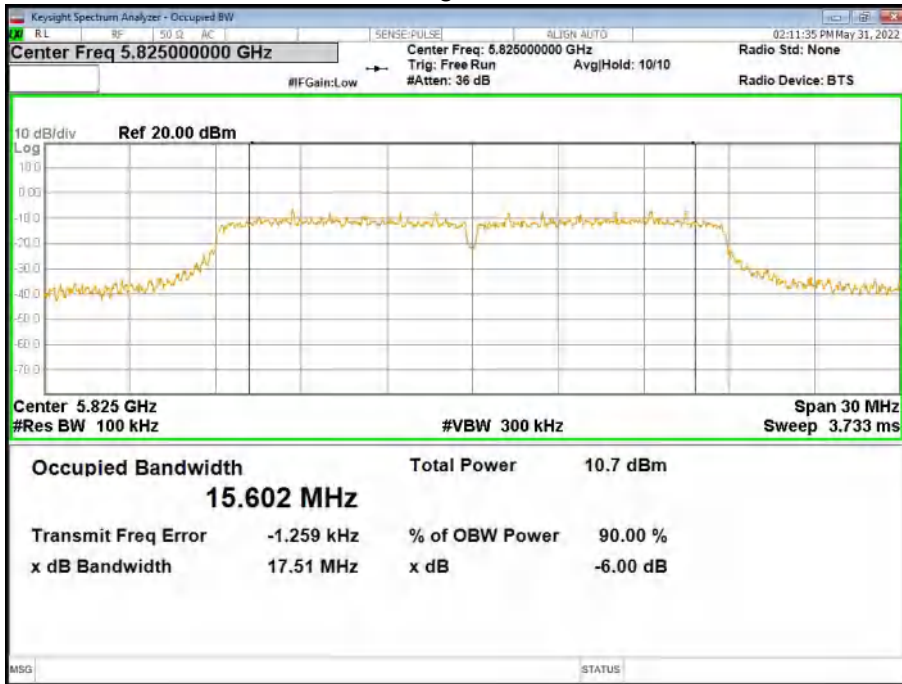

U-NII-3 11n(HT20) Low CH 5745MHZ

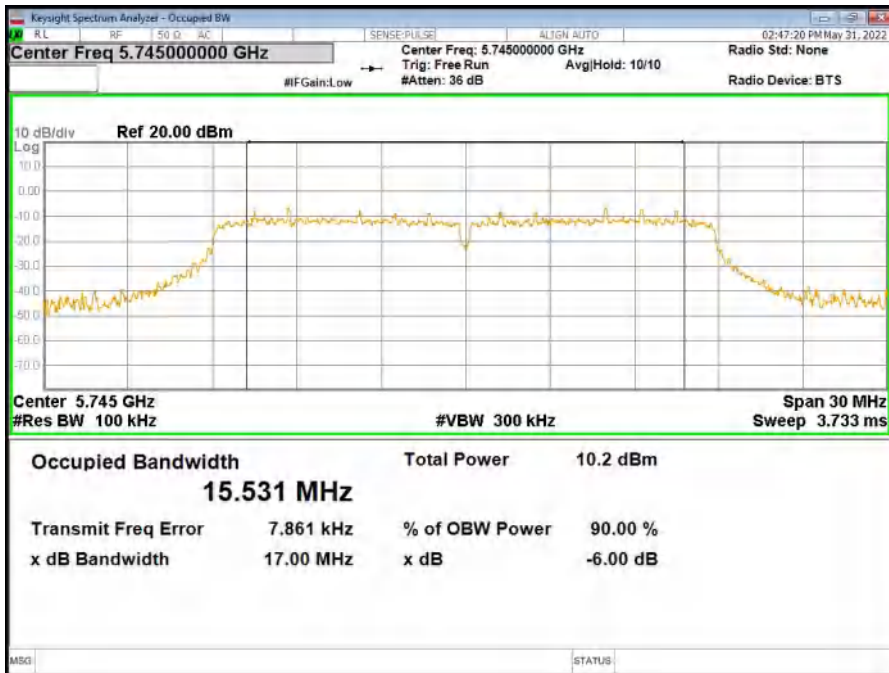



U-NII-3 11n(HT20) Middle CH 5785MHZ

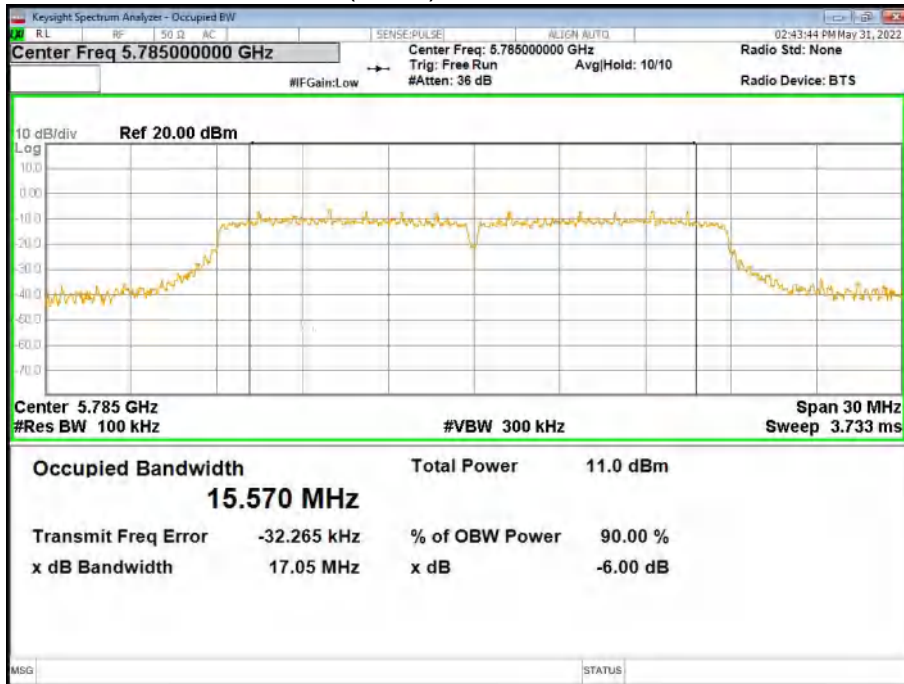

U-NII-3 11n(HT20) High CH 5825MHZ

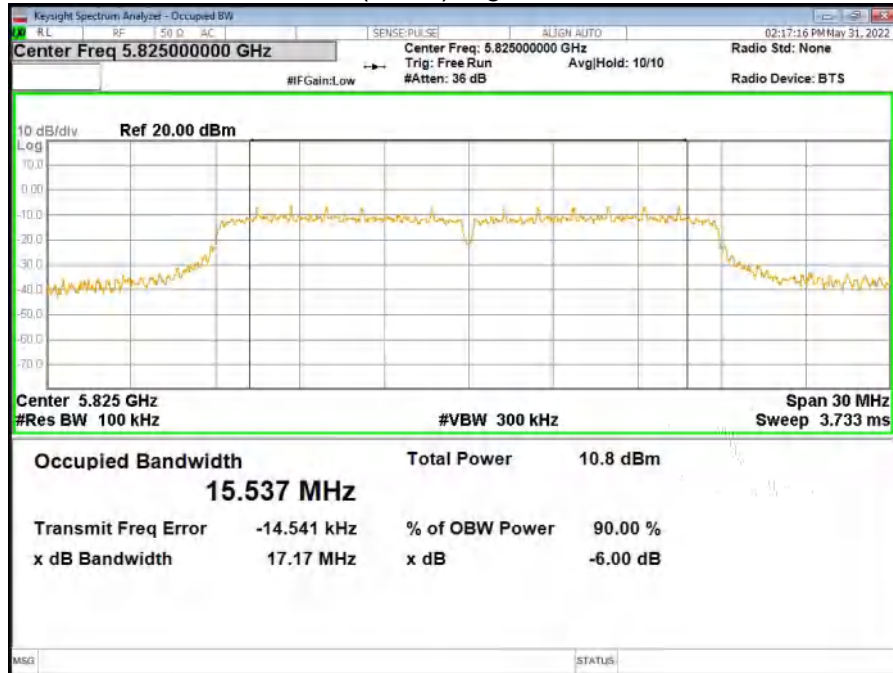

U-NII-3 11n(HT40) Low CH 5755MHZ

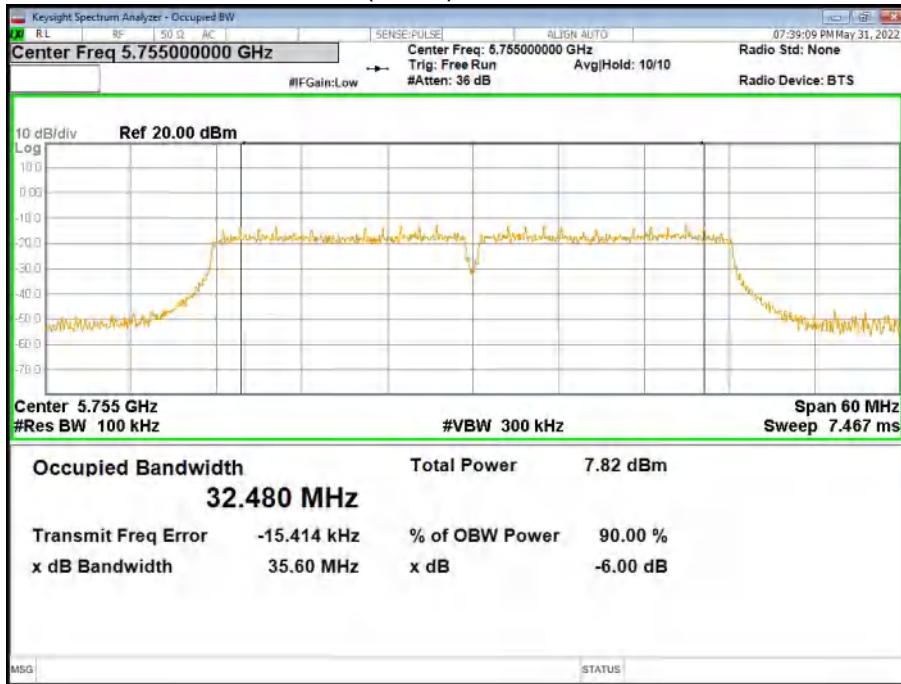

U-NII-3 11n(HT40) High CH 5795MHZ

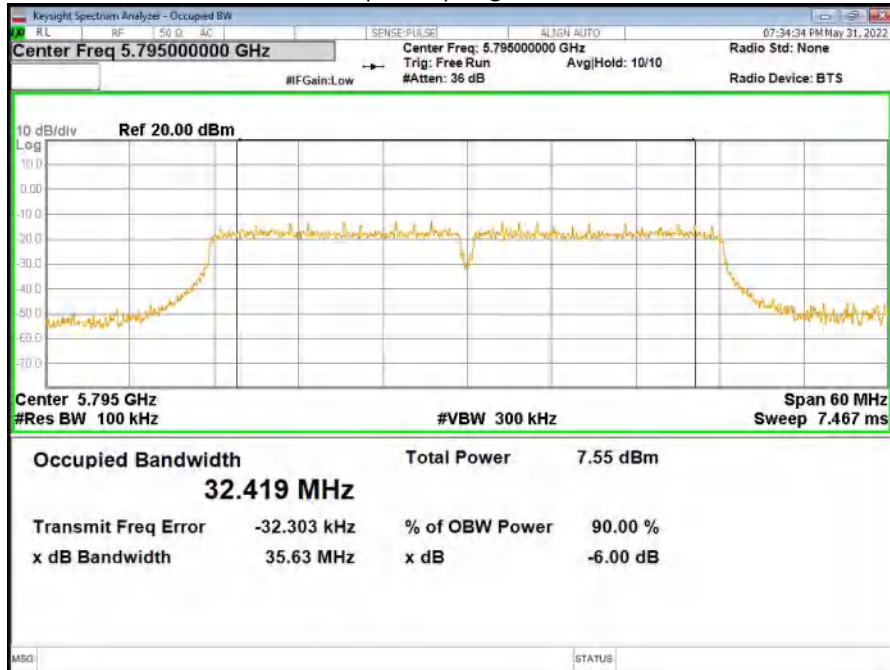

U-NII-3 11ac(HT20) Low CH 5745MHZ

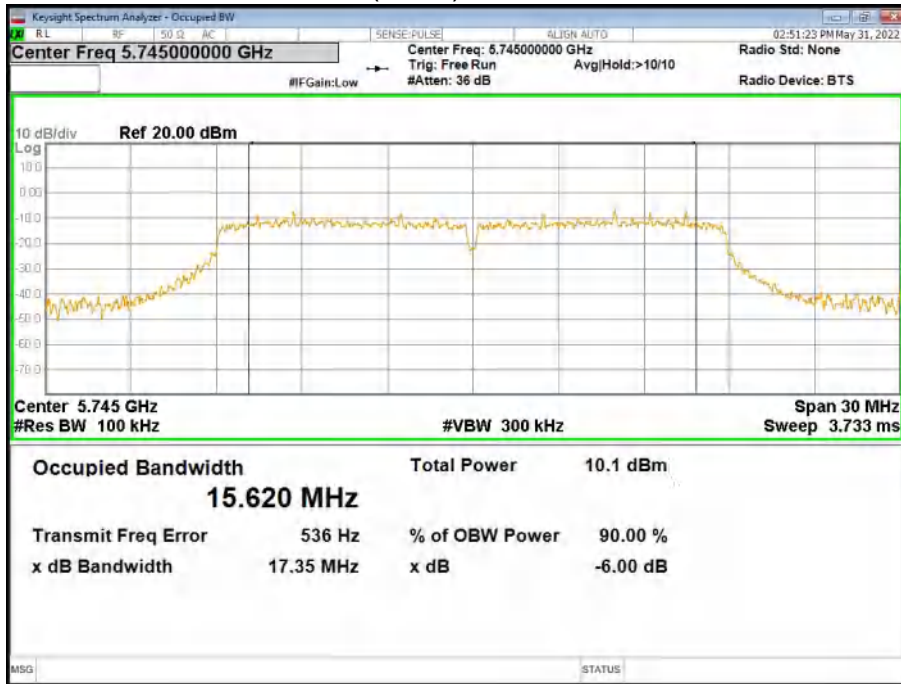

U-NII-3 11ac(HT20) Middle CH 5785MHZ

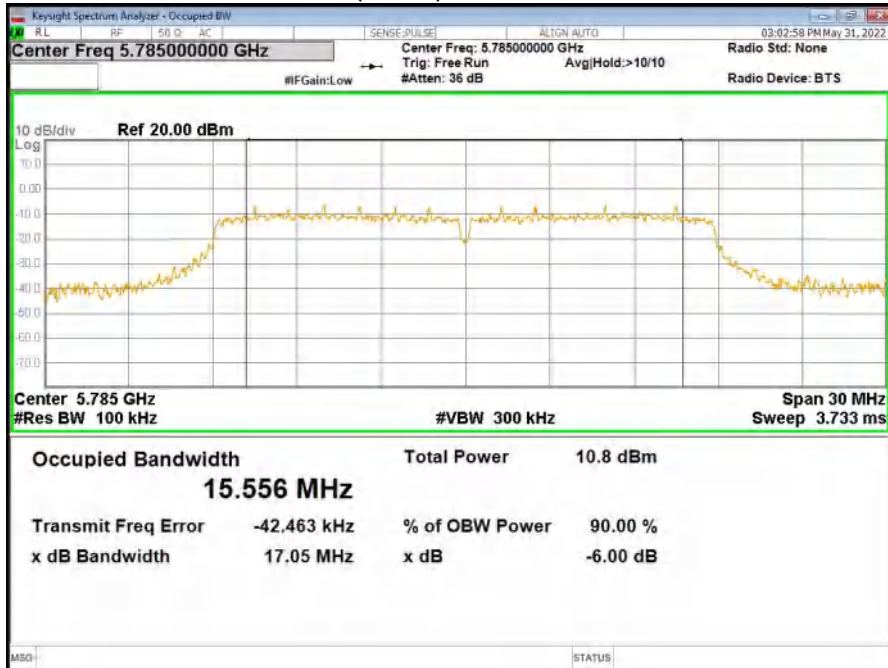

U-NII-3 11ac(HT20) High CH 5825MHZ

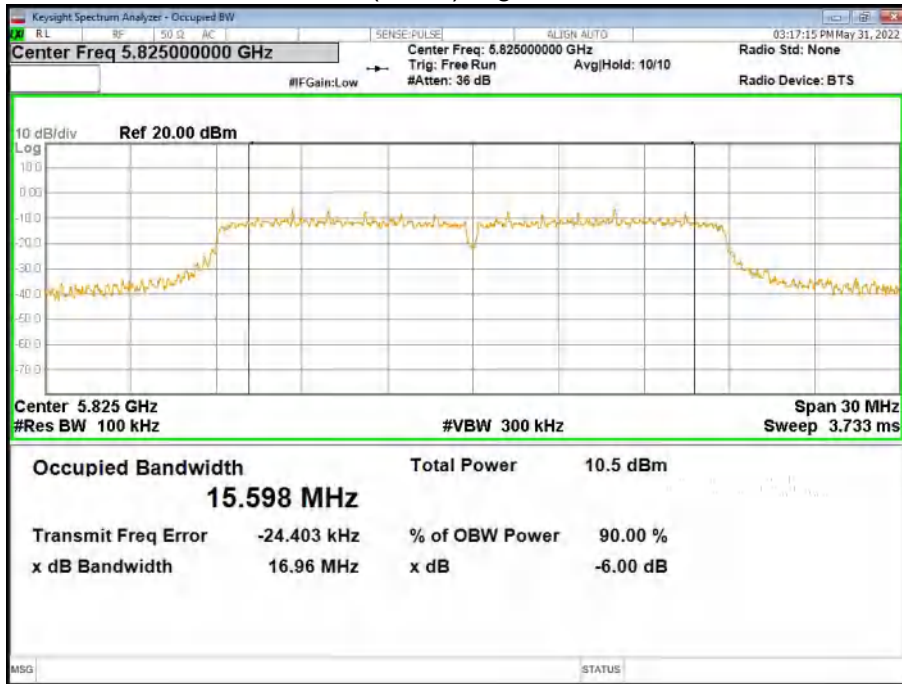

U-NII-3 11ac(HT40) Low CH 5755MHZ

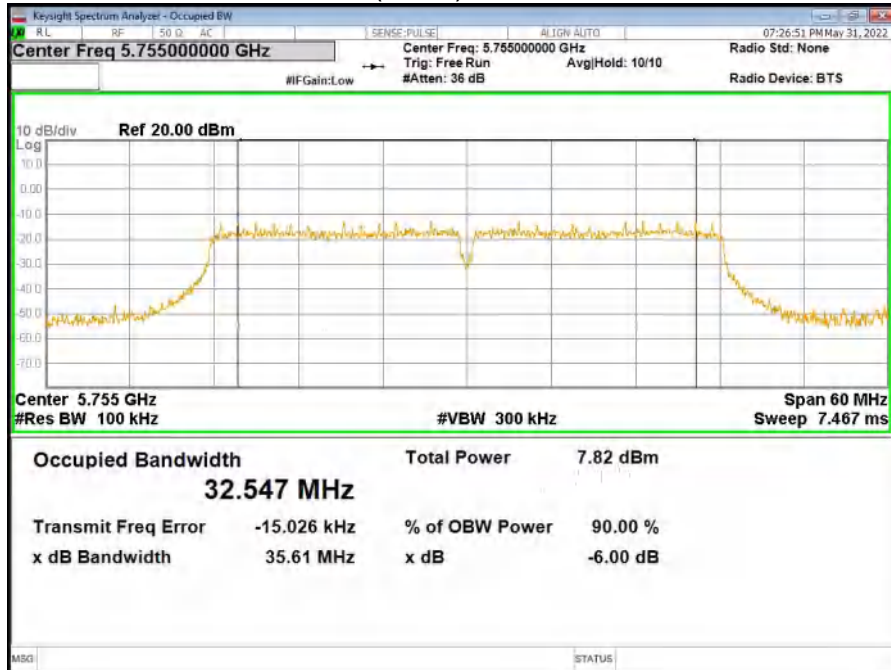

U-NII-3 11ac(HT40) High CH 5795MHZ

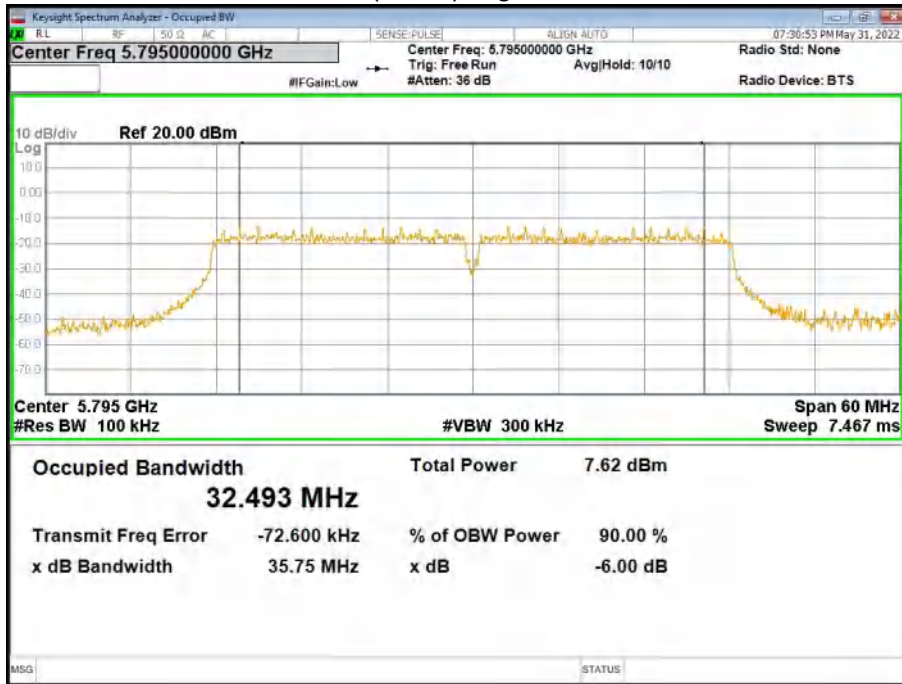

U-NII-3 11ac(HT80) Low CH 5775MHZ

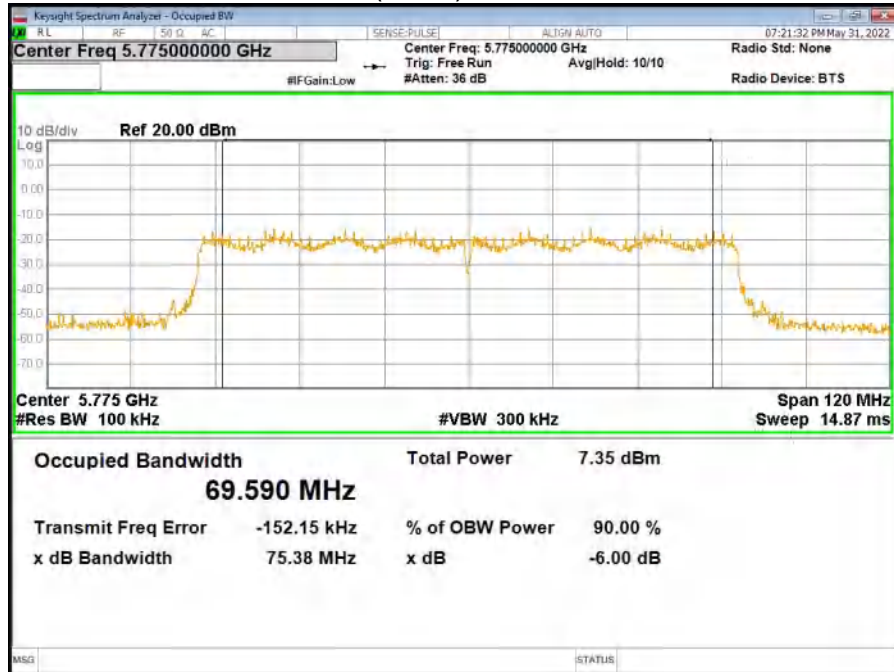

4 CONDUCTED OUTPUT POWER

4.1 limit

FCC Part15, Subpart E/ RSS-247		
Test Item	Limit	Frequency Range (MHz)
Conducted Output Power	For FCC client devices: 250mW (24dBm)	5150-5250
	For RSS: e.i.r.p. power: not exceed 200 mW(23dBm) or $10 + 10 \log_{10} B$	
	250mW (24dBm) or $11 + 10 \log_{10} B$	5250-5350
	250mW (24dBm) or $11 + 10 \log_{10} B$	For FCC:5470-5725 For IC:5470-5600 5650-5725
	1 Watt (30dBm)	5725-5850

Note: For ISSED: B=99% bandwidth.

4.2 test procedure

- a. Connect each EUT's antenna output to power meter by RF cable and attenuator
- b. Get each antenna port's output power of EUT.

4.3 TEST SETUP



4.4 test results

ANT 1

Band	Operation mode	Coneucted Output Power(dBm)		
		Low	Middle	High
U-NIM	802.11a	5.43	6.03	6.35
	802.11 n(HT20)	5.19	5.98	6.30
	802.11 n(HT40)	3.2	/	7.25
	802.11ac(HT20)	5.07	5.93	6.31
	802.11ac(HT40)	3.16	/	7.28
	802.11ac(HT80)	2.27	/	/
U-NII-3	802.11a	12.43	13.07	12.93
	802.11 n(HT20)	12.41	13.24	12.95
	802.11 n(HT40)	7.65	/	7.35
	802.11ac(HT20)	12.37	13.09	12.81
	802.11ac(HT40)	7.58	/	7.33
	802.11ac(HT80)	10.79	/	/

ANT 2

Band	Operation mode	Coneucted Output Power(dBm)		
		Low	Middle	High
U-NIM	802.11a	4.71	4.12	5.39
	802.11 n(HT20)	4.76	4.10	5.38
	802.11 n(HT40)	2.91	/	6.39
	802.11ac(HT20)	4.70	4.06	5.34
	802.11ac(HT40)	2.92	/	7.02
	802.11ac(HT80)	2.27	/	/
U-NII-3	802.11a	10.41	12.20	11.97
	802.11 n(HT20)	10.43	12.43	11.98
	802.11 n(HT40)	10.65	/	10.42
	802.11ac(HT20)	10.46	12.30	12.00
	802.11ac(HT40)	10.71	/	10.47
	802.11ac(HT80)	10.74	/	/

MIMO

Band	Operation mode	Coneucted Output Power(dBm)		
		Low	Middle	High
U-NIM	802.11a	5.68	6.29	6.48
	802.11 n(HT20)	5.44	6.23	6.53
	802.11 n(HT40)	3.61	/	7.68
	802.11ac(HT20)	5.41	6.33	6.66
	802.11ac(HT40)	3.25	/	7.52
	802.11ac(HT80)	2.36	/	/
U-NII-3	802.11a	12.59	13.26	13.04
	802.11 n(HT20)	12.57	13.42	13.11
	802.11 n(HT40)	10.19	/	10.67
	802.11ac(HT20)	12.58	13.28	12.93
	802.11ac(HT40)	10.98	/	10.72
	802.11ac(HT80)	11.06	/	/

5. POWER SPECTRAL DENSITY

5.1 LIMIT

FCC Part15, Subpart E/ RSS-247		
Test Item	Limit	Frequency Range (MHz)
Power Spectral Density	For FCC: Other than Mobile and portable:17dBm/MHz Mobile and portable:11dBm/MHz	5150-5250
	For RSS eirp:10dBm/MHz	
	11dBm/MHz	5250-5350
	11dBm/MHz	For FCC:5470-5725 For IC:5470-5600 5650-5725
	30dBm/500kHz	5725-5850

5.2 TEST PROCEDURE

The transmitter output was connected to a spectrum analyzer. Power density was measured by spectrum analyzer with 1MHz RBW and 3MHz VBW.

Connect the UUT to the spectrum analyser and use the following settings:

5725MHz-5850MHz

Note:

1. For UNII-3, according to KDB publication 789033 D02 General UNII Test Procedures New Rules v01, section II.F.5., it is acceptable to set RBW at 1MHz and VBW at 3MHz if the spectrum analyzer does not have 500kHz RBW.
2. The value measured with RBW=1MHz is to be added with $10\log(500\text{kHz}/1\text{MHz})$ which is - 3dB. For example, if the measured value is +10dBm using RBW=1MHz (that is +10dBm/MHz), then the converted value will be +7dBm/500kHz.

Allow trace to fully stabilize and use the peak marker function to determine the maximum amplitude level within the RBW.

5.3 TEST SETUP

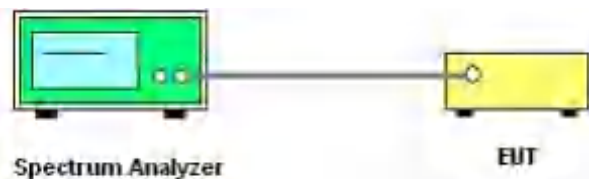

5.4 TEST RESULTS

ANT 1

Band	Operation mode	Power Spectral Density(dBm/MHz)		
		Low	Middle	High
U-NIM	802.11a	-5.940	-6.795	-4.476
	802.11 n(HT20)	-5.457	-6.030	-4.495
	802.11 n(HT40)	-10.423	/	-6.326
	802.11ac(HT20)	-5.460	-6.073	-4.489
	802.11ac(HT40)	-10.232	/	-6.245
	802.11ac(HT80)	-12.831	/	/
U-NII-3	802.11a	-2.031	-1.106	-1.412
	802.11 n(HT20)	-1.899	-0.821	-1.232
	802.11 n(HT40)	-7.074	/	-7.697
	802.11ac(HT20)	-1.900	0.966	-1.419
	802.11ac(HT40)	-7.255	/	-7.493
	802.11ac(HT80)	-8.779	/	/

ANT 2

Band	Operation mode	Power Spectral Density(dBm/MHz)		
		Low	Middle	High
U-NIM	802.11a	-5.260	-4.692	-4.229
	802.11 n(HT20)	-5.405	-4.256	-4.326
	802.11 n(HT40)	-9.991	/	-5.977
	802.11ac(HT20)	-5.216	-4.310	-3.458
	802.11ac(HT40)	-9.957	/	-6.002
	802.11ac(HT80)	-12.656	/	/
U-NII-3	802.11a	-3.134	-2.009	-1.497
	802.11 n(HT20)	-3.051	-1.368	-1.455
	802.11 n(HT40)	-6.611	/	-6.775
	802.11ac(HT20)	-3.193	1.853	-1.775
	802.11ac(HT40)	-6.491	/	-7.149
	802.11ac(HT80)	-8.364	/	/

MIMO

Band	Operation mode	Power Spectral Density(dBm/MHz)		
		Low	Middle	High
U-NIM	802.11a	-5.517	-6.369	-5.046
	802.11 n(HT20)	-5.311	-6.121	-4.462
	802.11 n(HT40)	-10.018	/	-6.612
	802.11ac(HT20)	-5.600	-5.943	-3.633
	802.11ac(HT40)	-9.748	/	-6.678
	802.11ac(HT80)	-12.639	/	/
U-NII-3	802.11a	-3.338	-1.351	-1.378
	802.11 n(HT20)	-3.774	-1.822	-1.846
	802.11 n(HT40)	-7.006	/	-6.842
	802.11ac(HT20)	-3.872	-3.328	-3.307
	802.11ac(HT40)	-6.973	/	-6.713
	802.11ac(HT80)	-8.234	/	/

5.5 original test data

ANT 1

U-NII-1 802.11a Low CH



U-NII-1 802.11a Middle CH

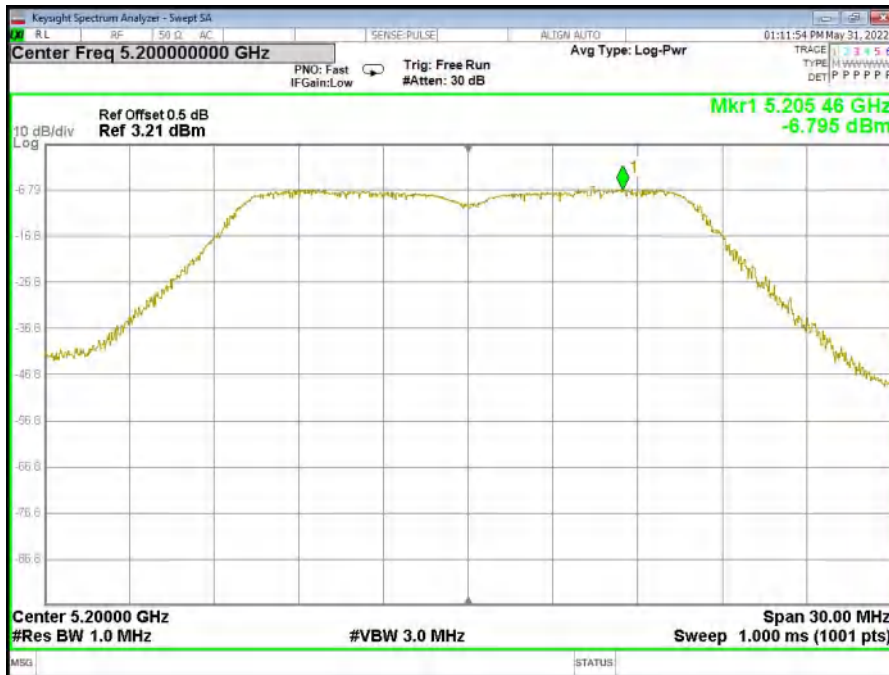

U-NII-1 802.11a High CH

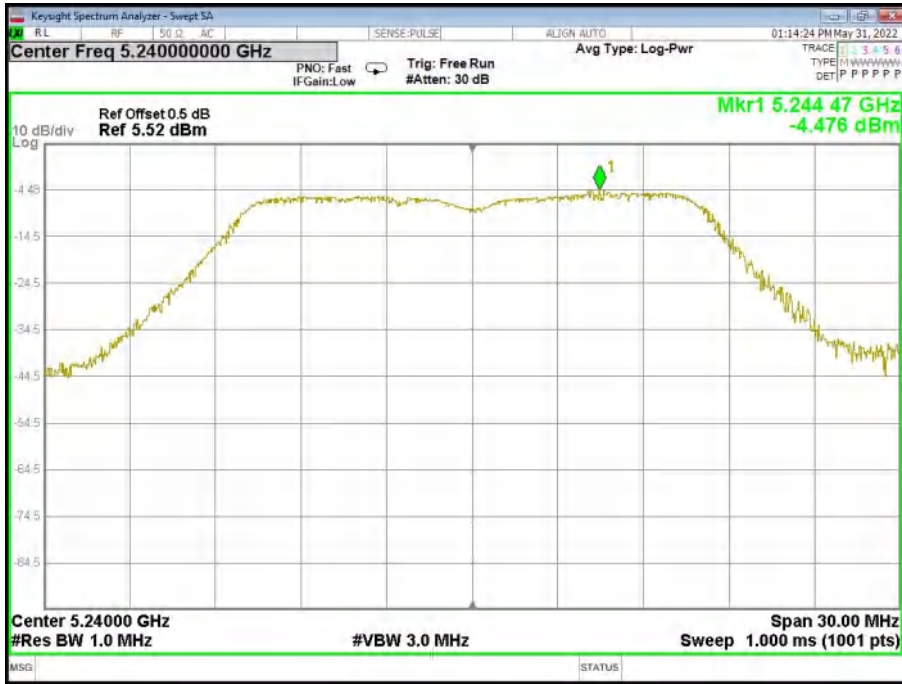

U-NII-1 802.11n(HT20) Low CH



U-NII-1 802.11n(HT20) Middle CH



U-NII-1 802.11n(HT20) High CH



U-NII-1 802.11n(HT40) Low CH

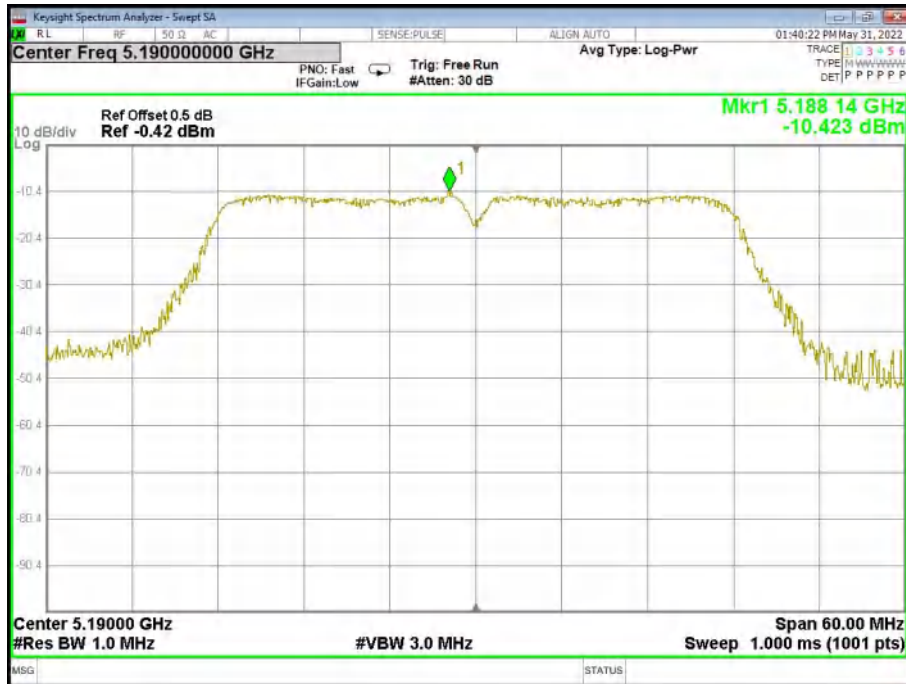

U-NII-1 802.11n(HT40) High CH

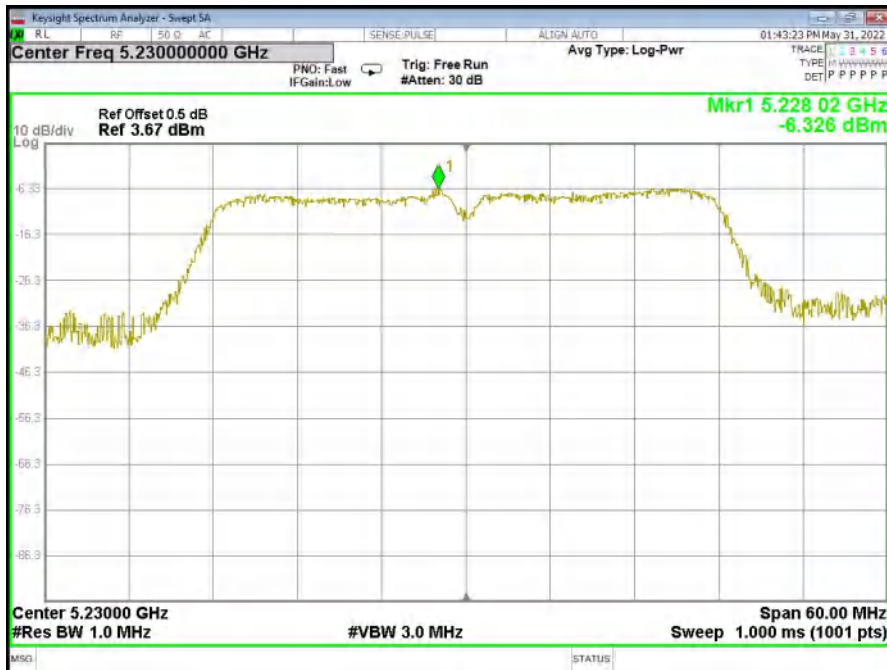

U-NII-1 802.11ac(HT20) Low CH

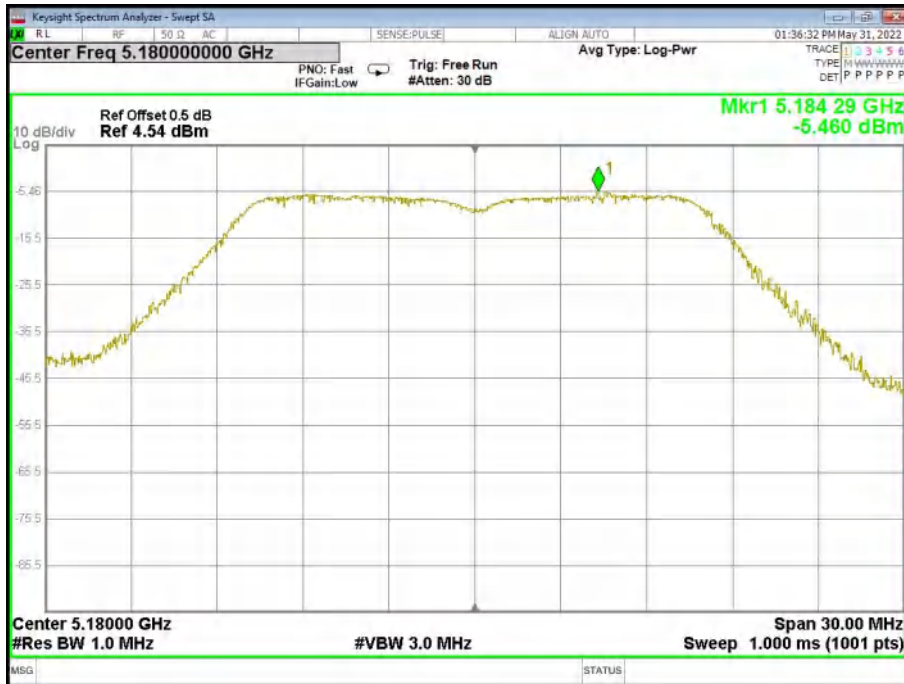

U-NII-1 802.11ac(HT20) Middle CH

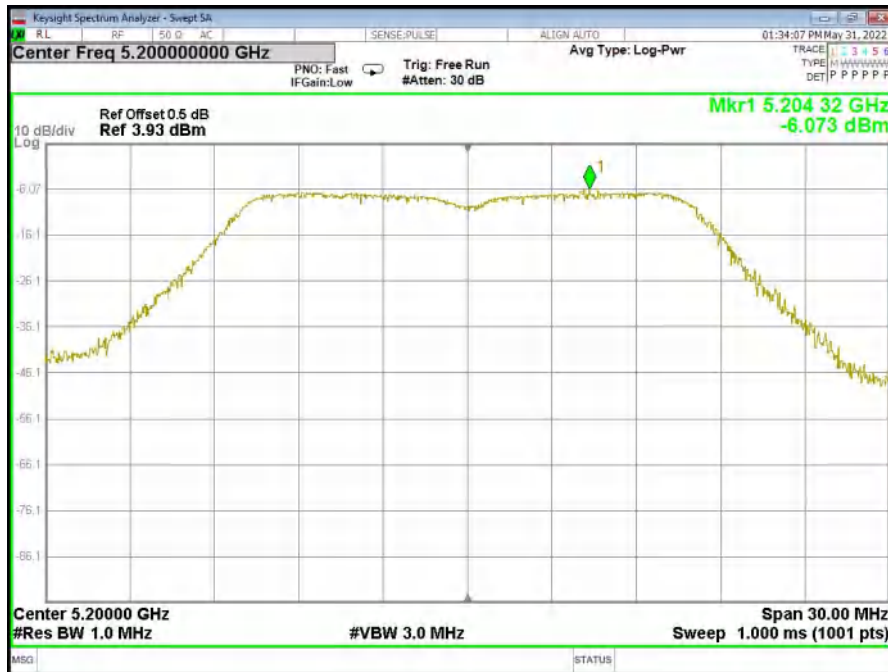

U-NII-1 802.11ac(HT20) High CH

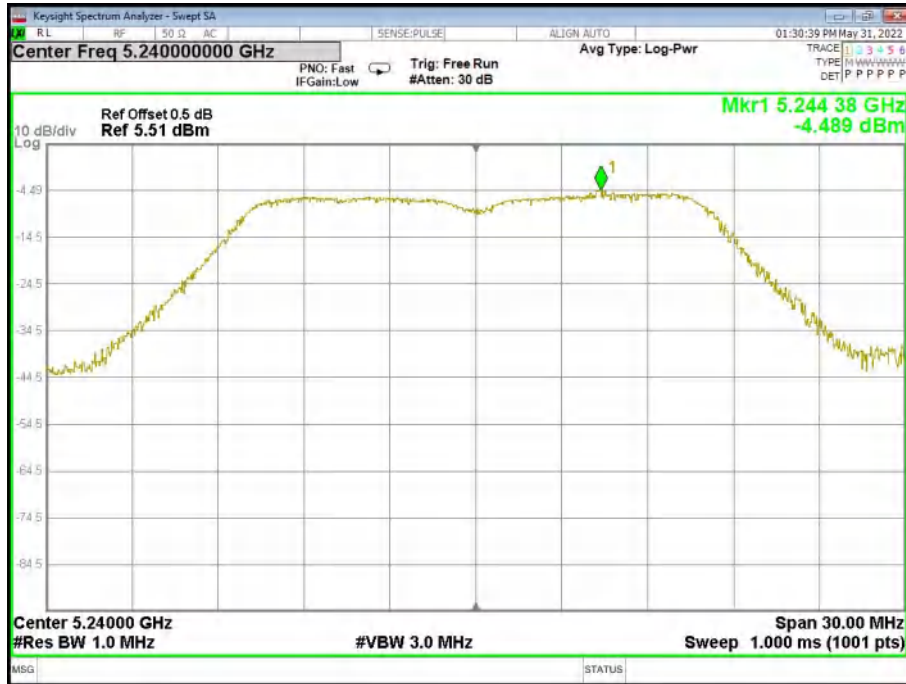

U-NII-1 802.11ac(HT40) Low CH

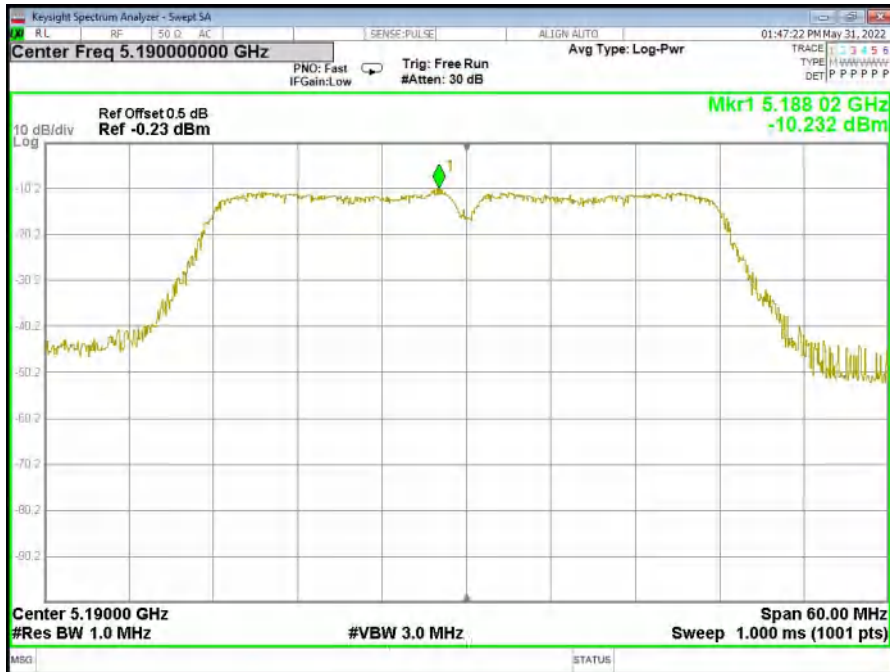

U-NII-1 802.11ac(HT40) High CH

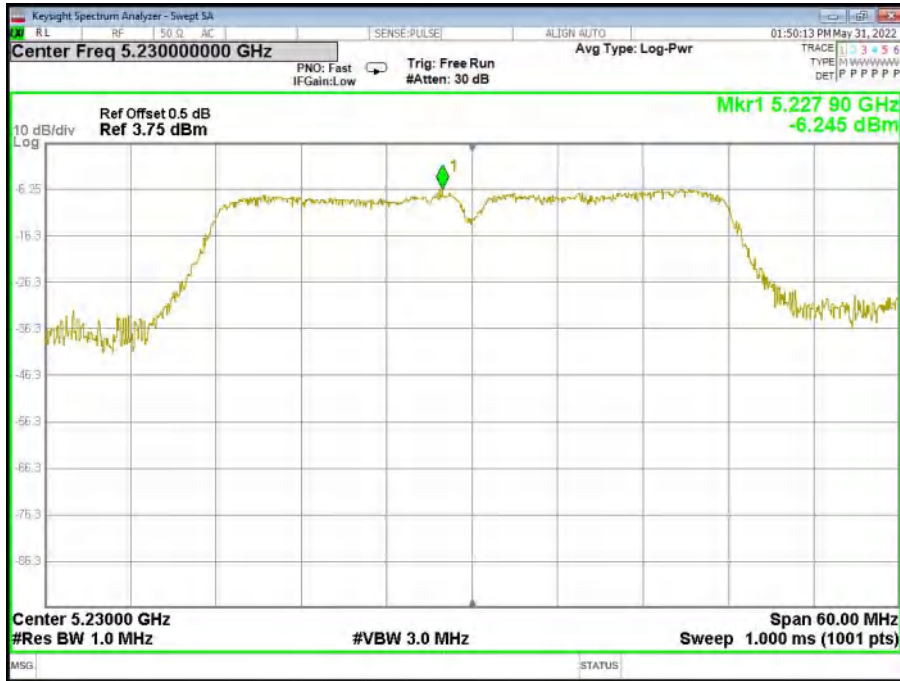

U-NII-1 802.11ac(HT80) Low CH

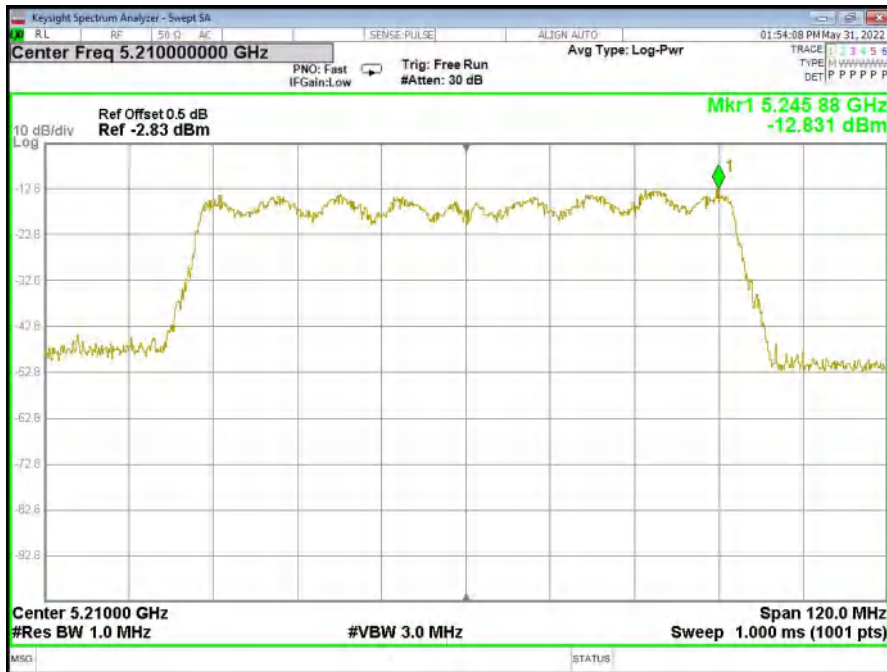

U-NII-3 802.11a Low CH

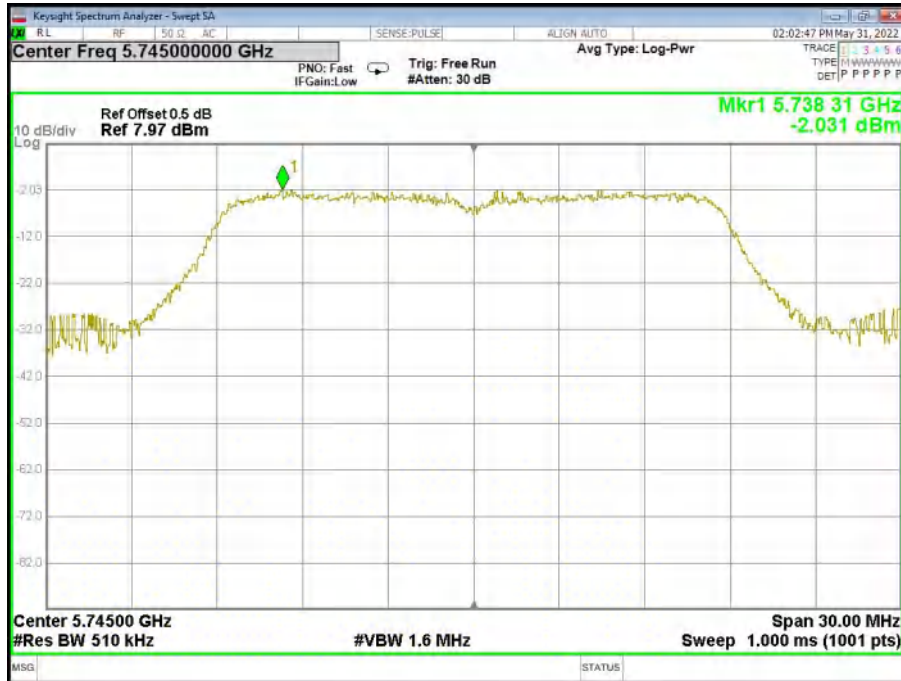

U-NII-3 802.11a Middle CH

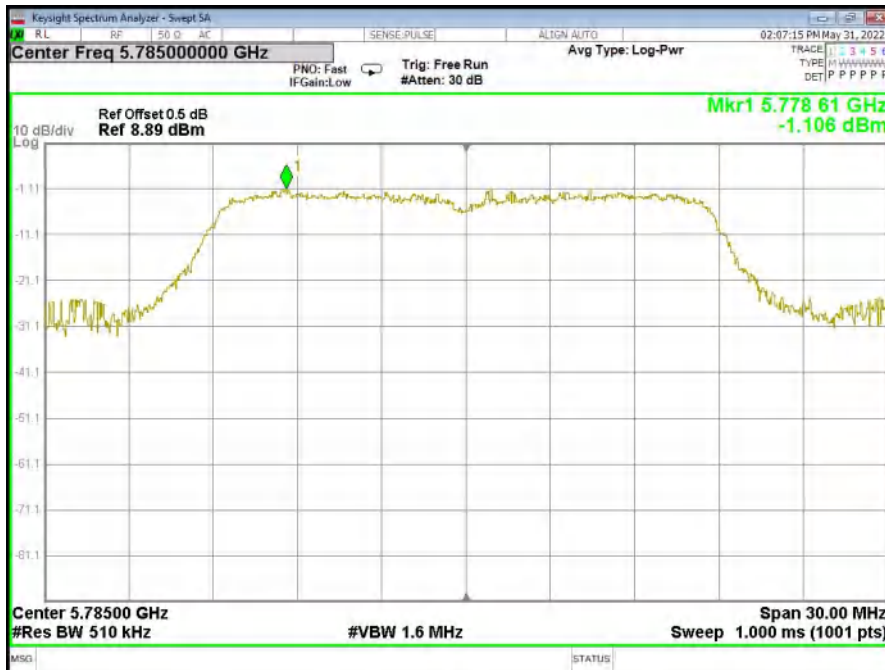

U-NII-3 802.11a High CH

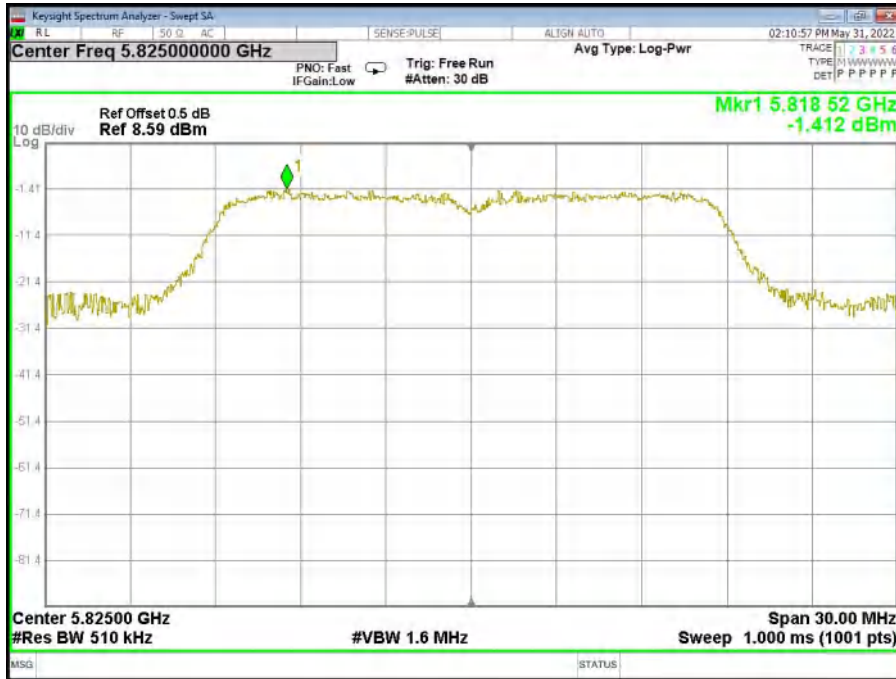

U-NII-3 802.11n(HT20) Low CH



U-NII-3 802.11n(HT20) Middle CH

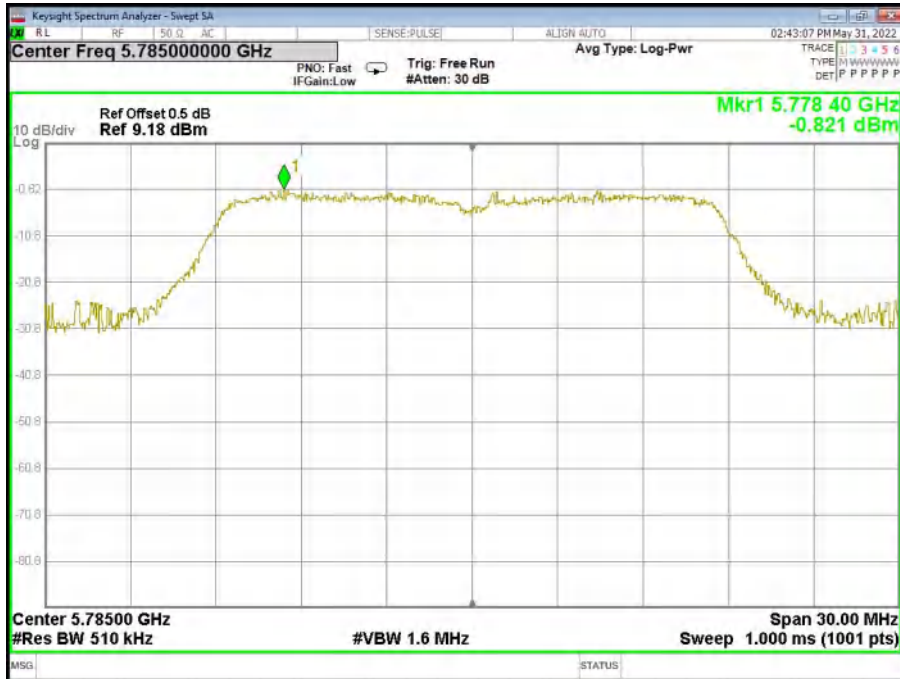

U-NII-3 802.11n(HT20) High CH

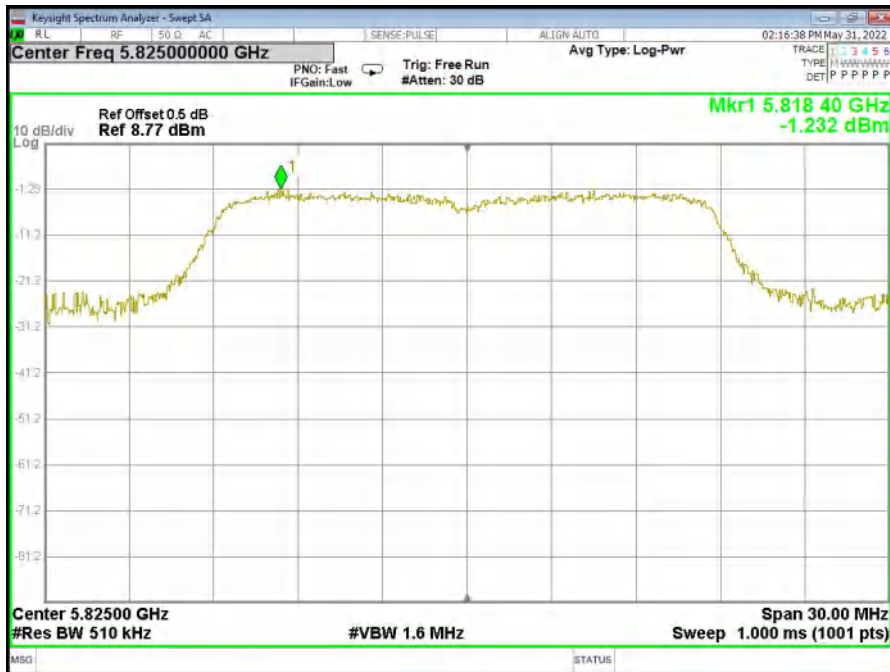

U-NII-3 802.11n(HT40) Low CH

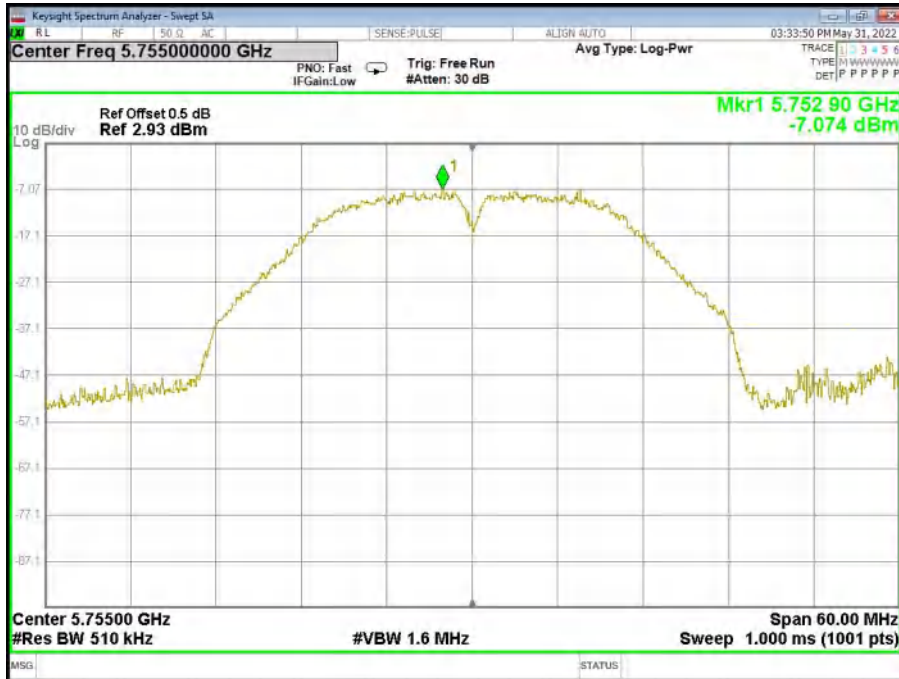

U-NII-3 802.11n(HT40) High CH



U-NII-3 802.11ac(HT20) Low CH



U-NII-3 802.11ac(HT20) Middle CH

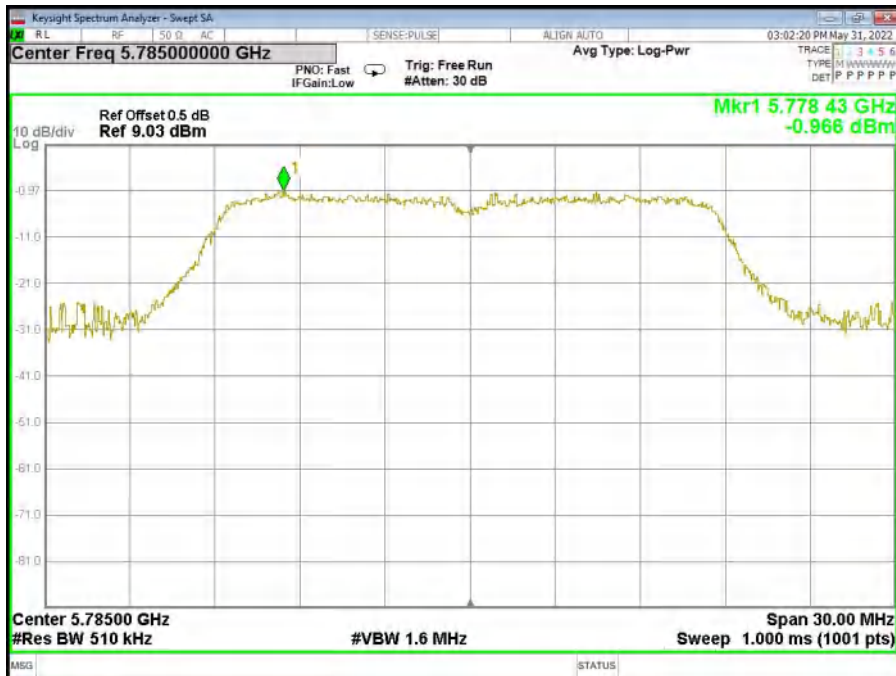

U-NII-3 802.11ac(HT20) High CH



U-NII-3 802.11ac(HT40) Low CH

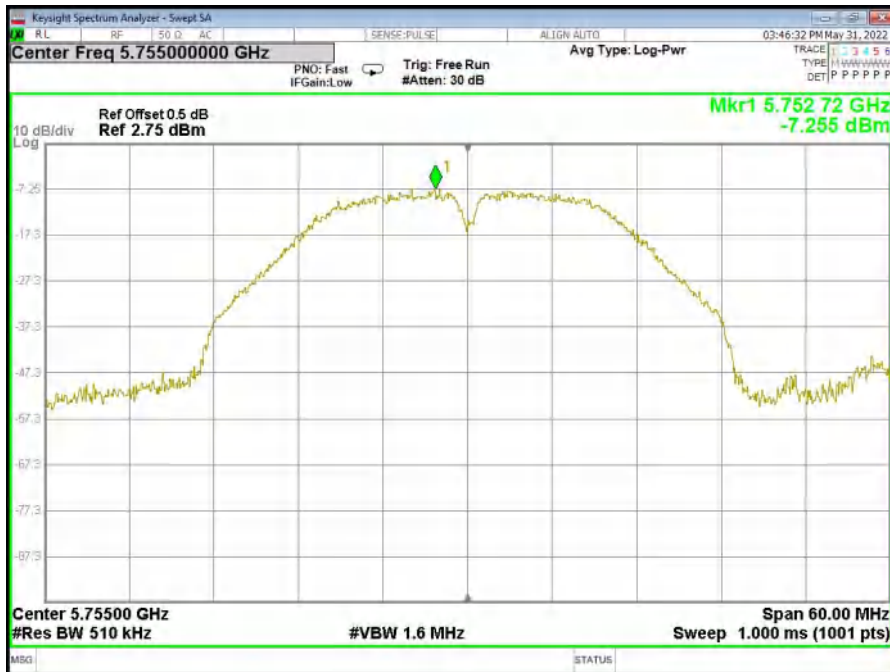

U-NII-3 802.11ac(HT40) High CH

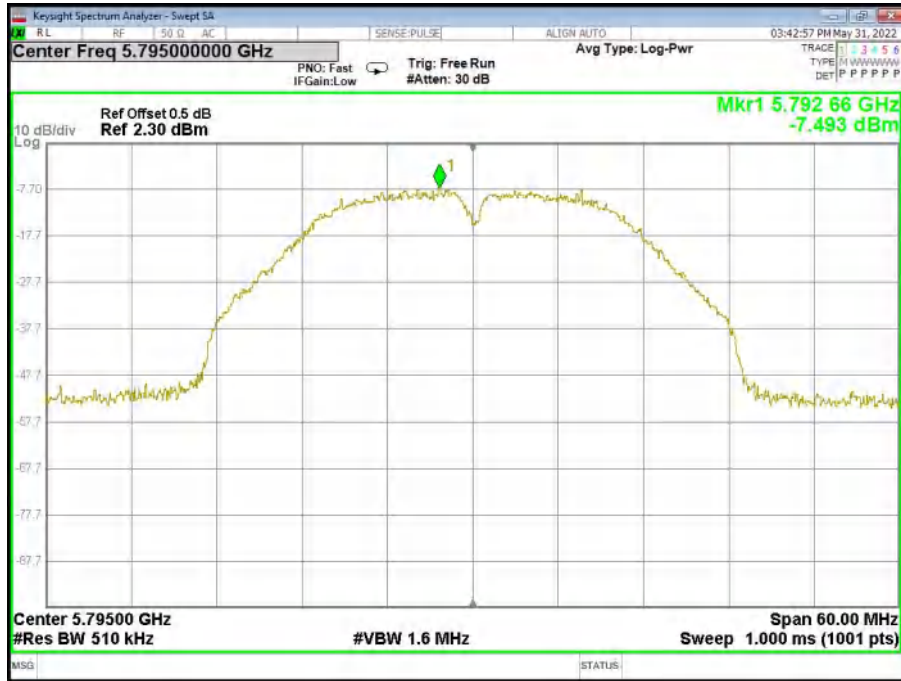

U-NII-3 802.11ac(H840) Low CH

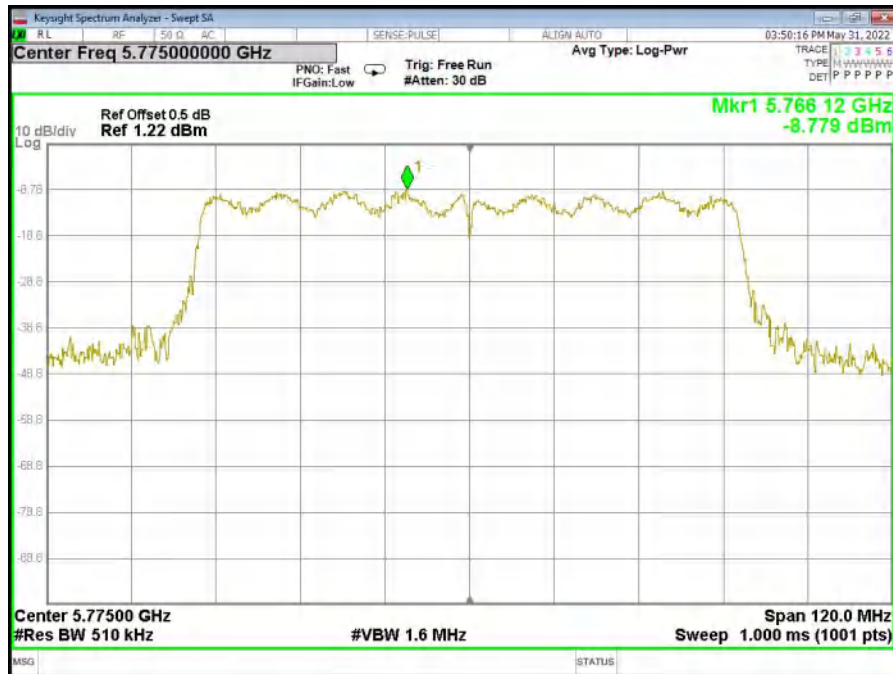

ANT 2

U-NII-1 802.11a Low CH

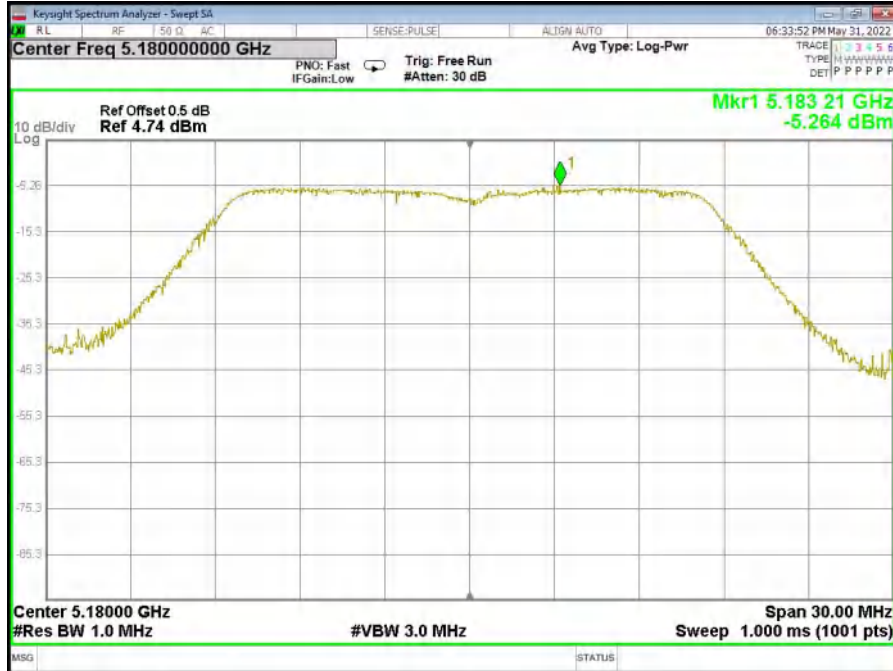

U-NII-1 802.11a Middle CH



U-NII-1 802.11a High CH

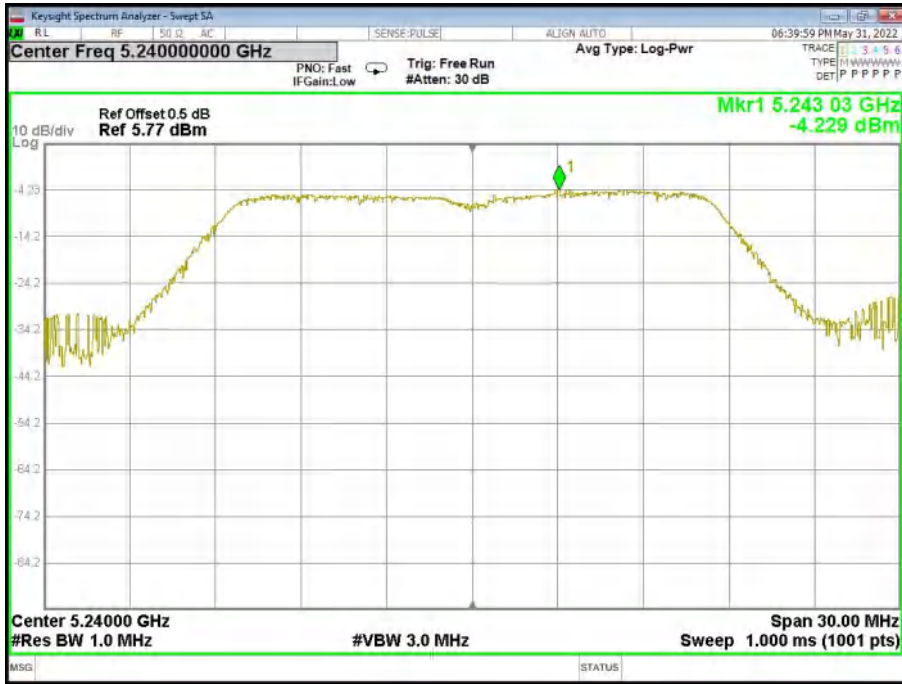

U-NII-1 802.11n(HT20) Low CH



U-NII-1 802.11n(HT20) Middle CH

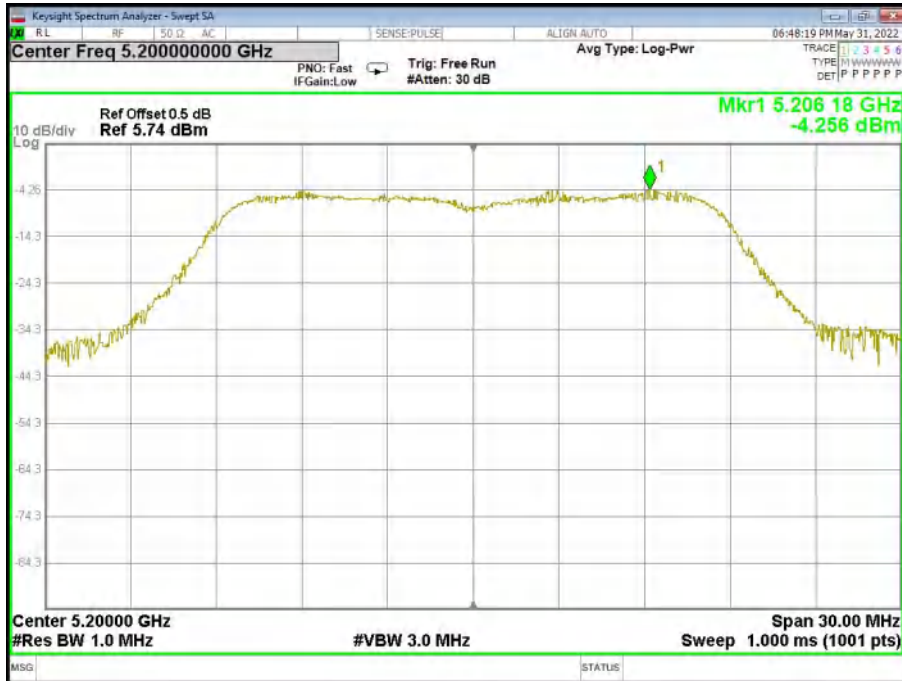

U-NII-1 802.11n(HT20) High CH

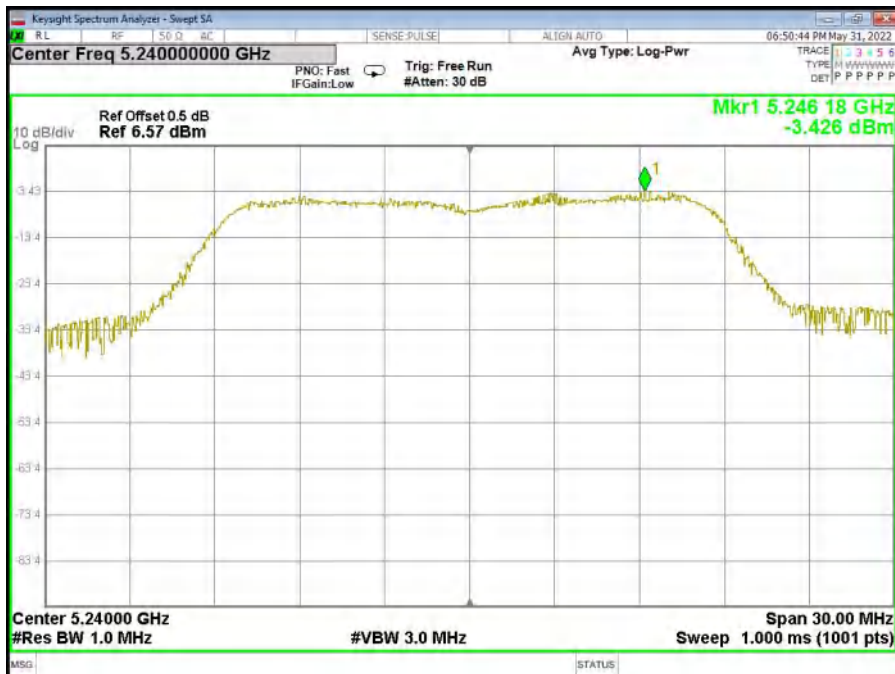

U-NII-1 802.11n(HT40) Low CH

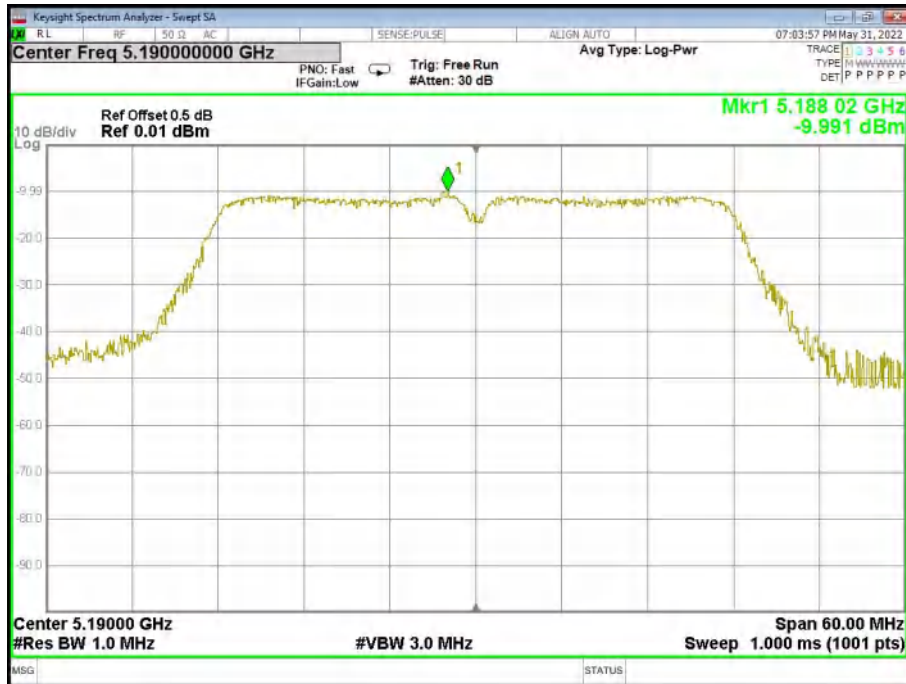

U-NII-1 802.11n(HT40) High CH

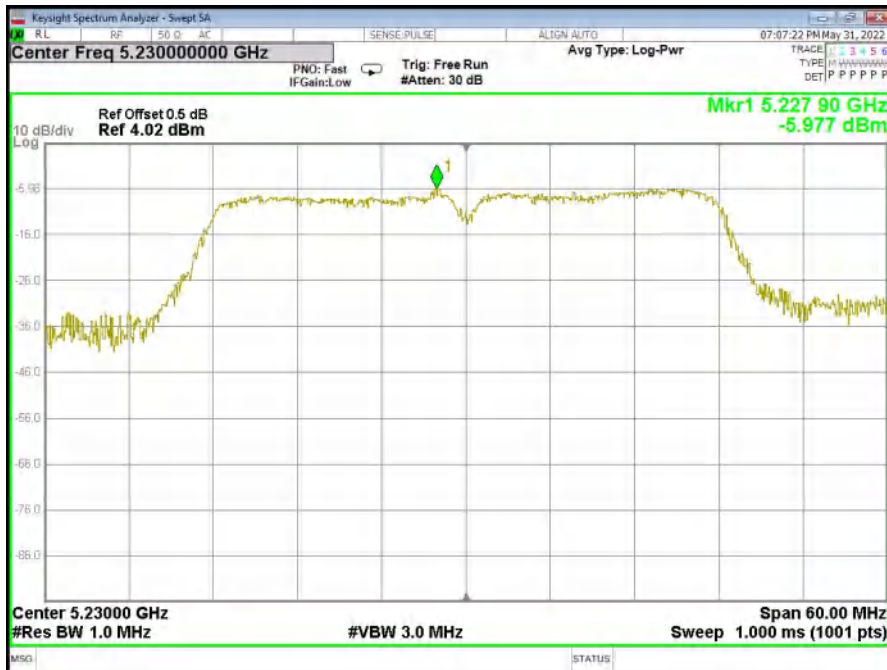

U-NII-1 802.11ac(HT20) Low CH

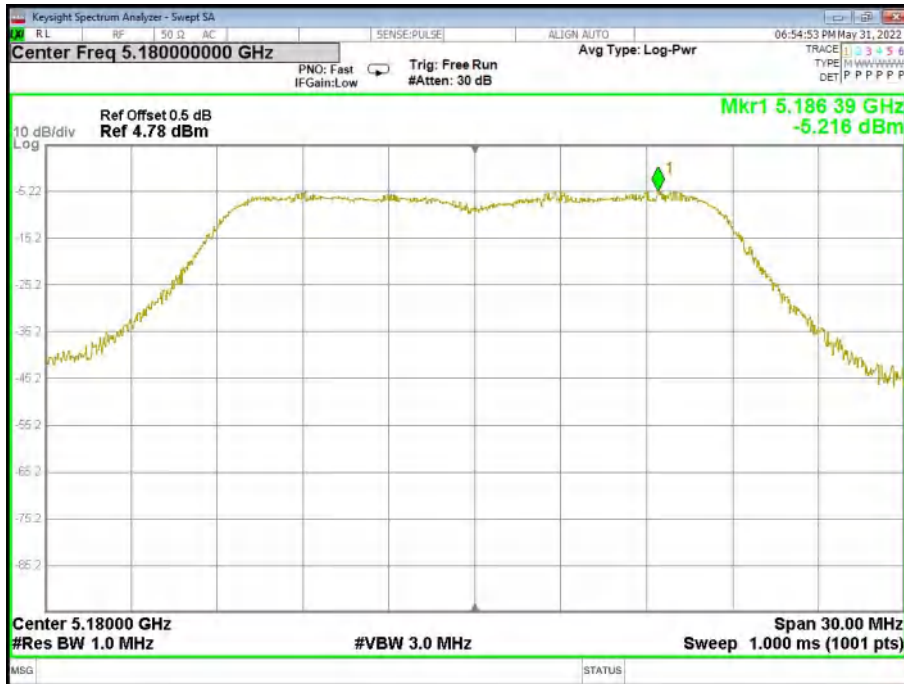

U-NII-1 802.11ac(HT20) Middle CH



U-NII-1 802.11ac(HT20) High CH

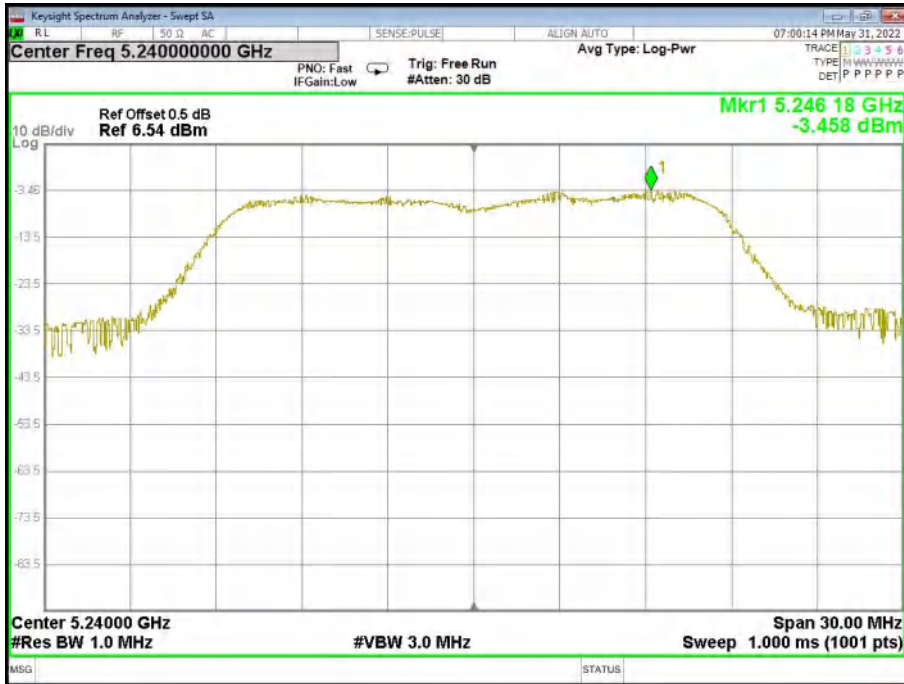

U-NII-1 802.11ac(HT40) Low CH

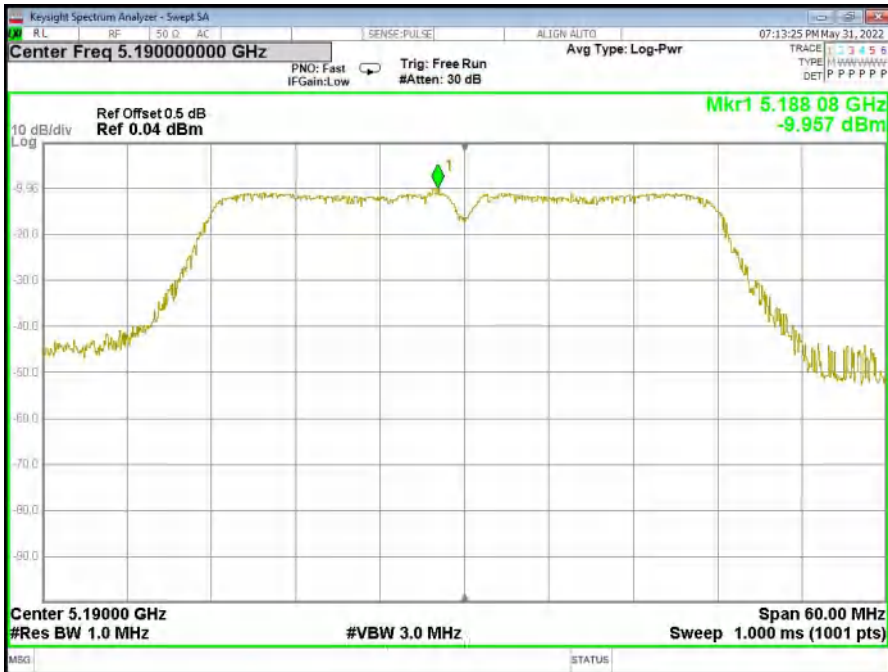

U-NII-1 802.11ac(HT40) High CH

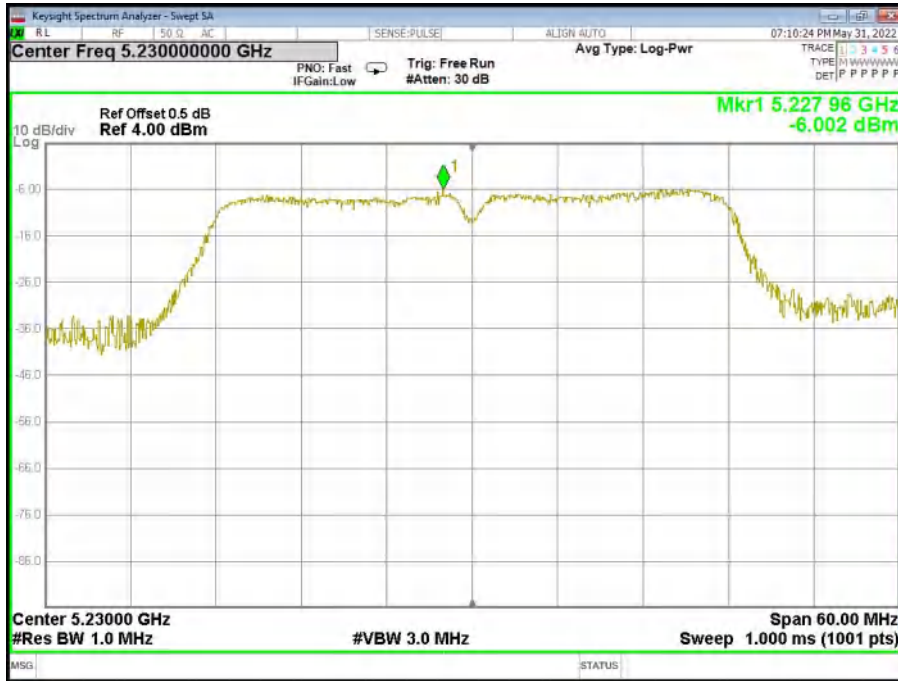

U-NII-1 802.11ac(HT80) Low CH

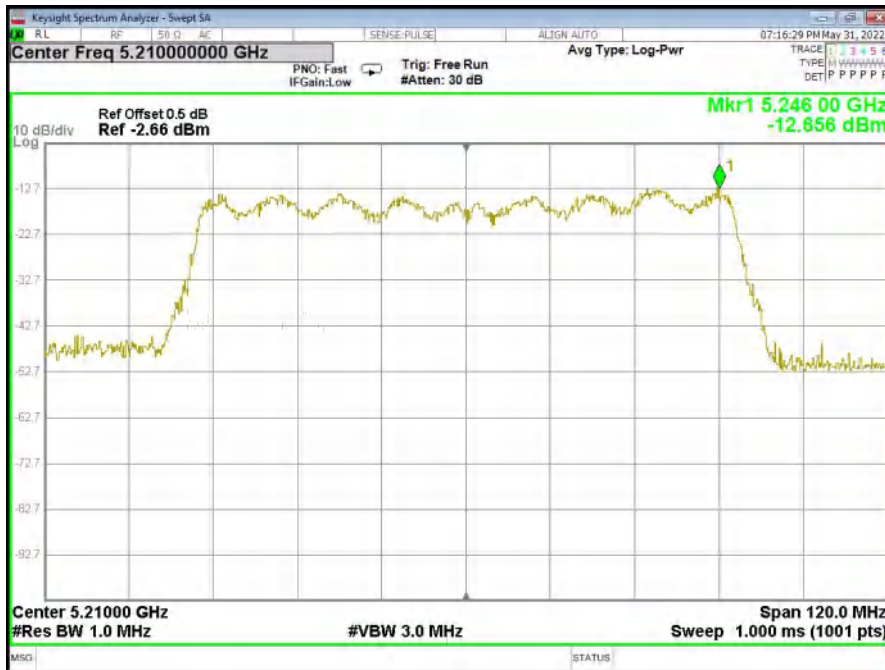

U-NII-3 802.11a Low CH



U-NII-3 802.11a Middle CH



U-NII-3 802.11a High CH

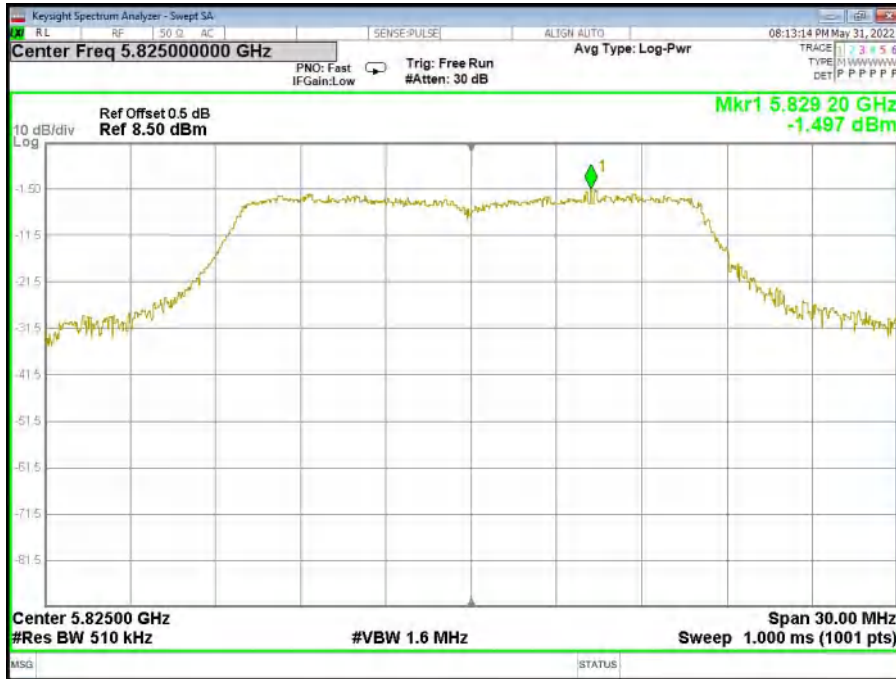

U-NII-3 802.11n(HT20) Low CH



U-NII-3 802.11n(HT20) Middle CH

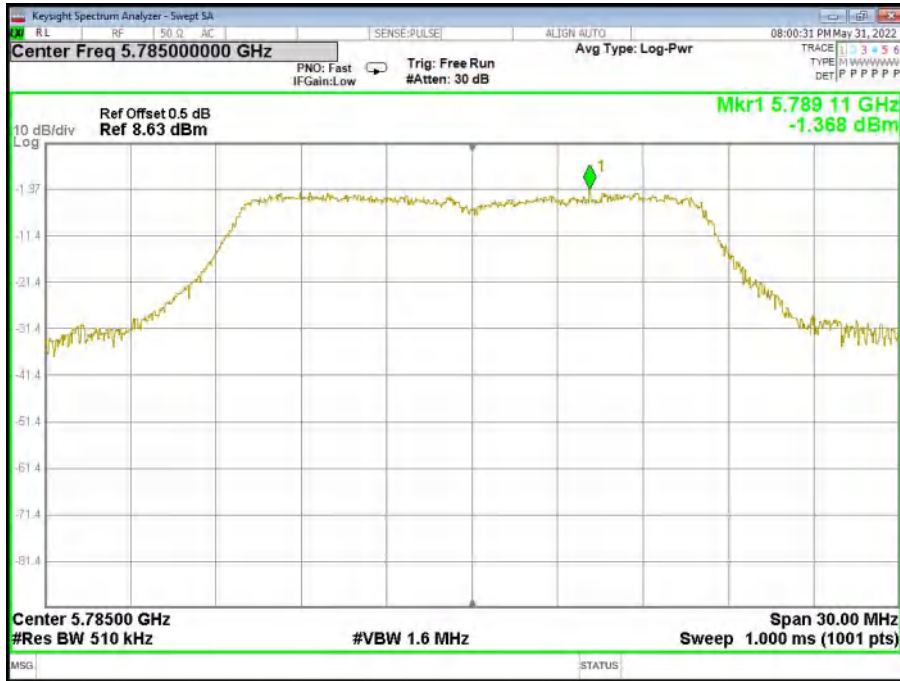

U-NII-3 802.11n(HT20) High CH

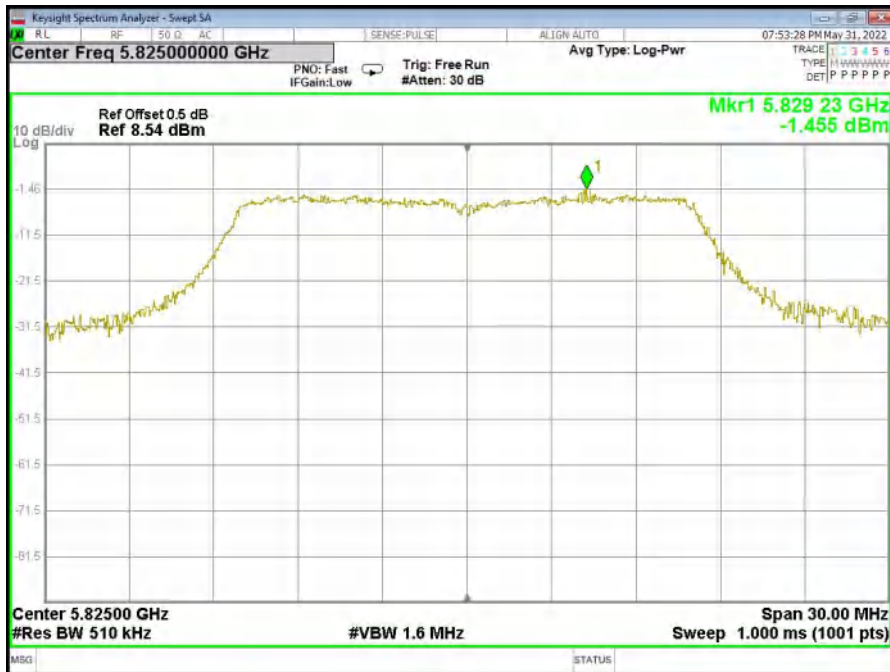

U-NII-3 802.11n(HT40) Low CH

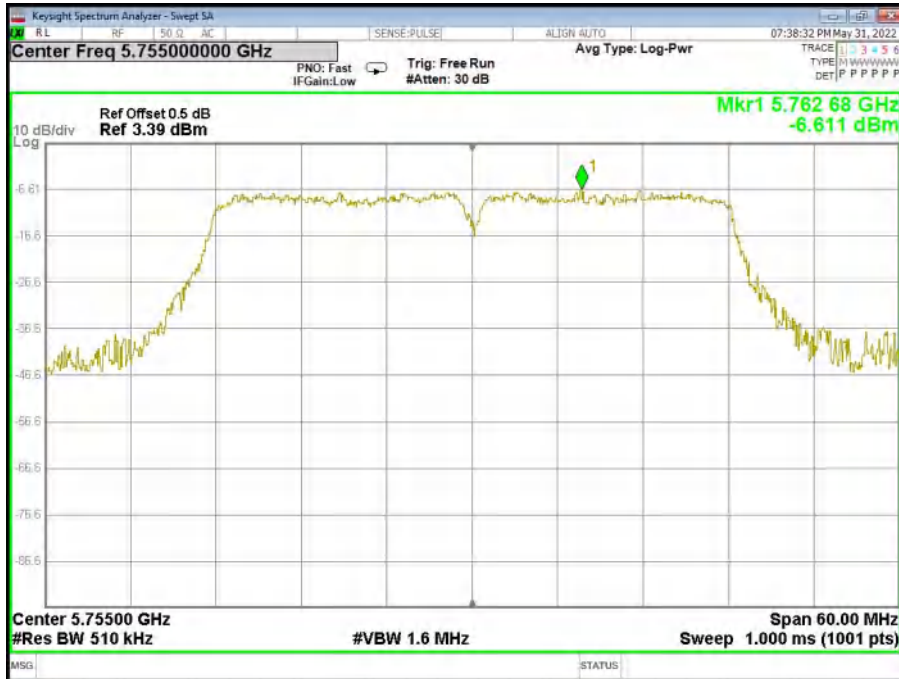

U-NII-3 802.11n(HT40) High CH



U-NII-3 802.11ac(HT20) Low CH



U-NII-3 802.11ac(HT20) Middle CH



U-NII-3 802.11ac(HT20) High CH

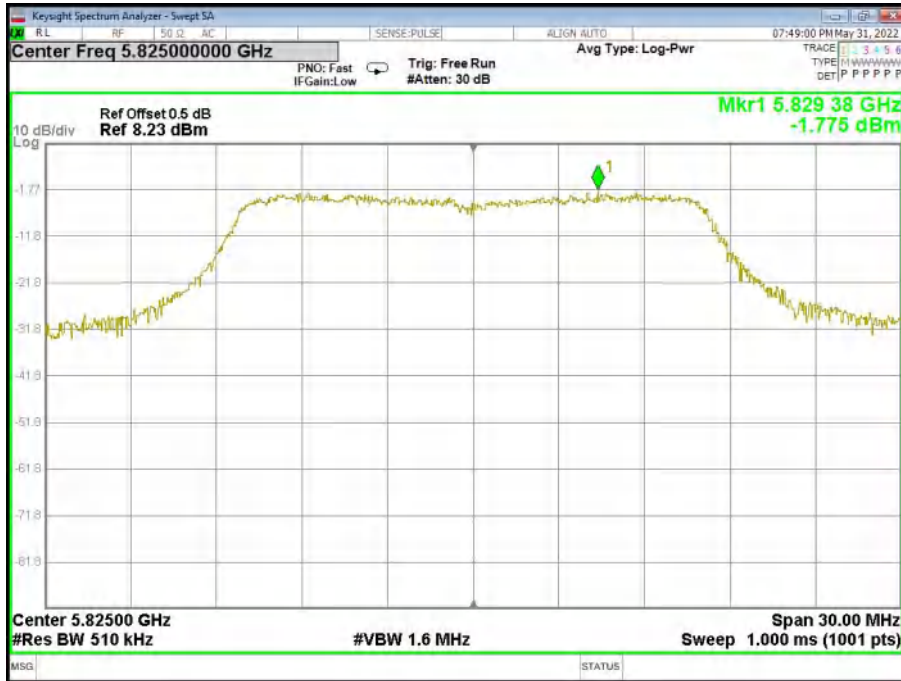

U-NII-3 802.11ac(HT40) Low CH

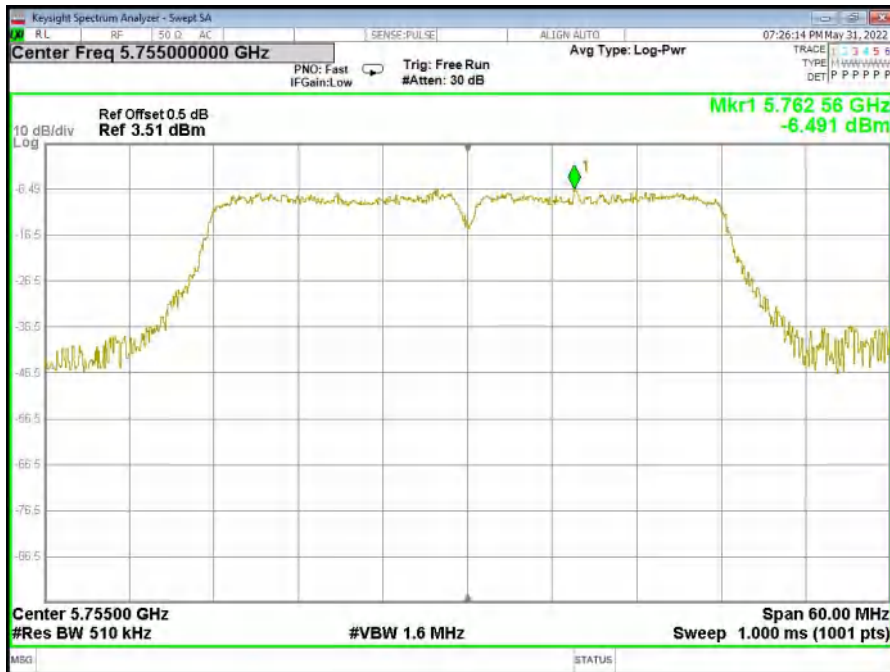

U-NII-3 802.11ac(HT40) High CH

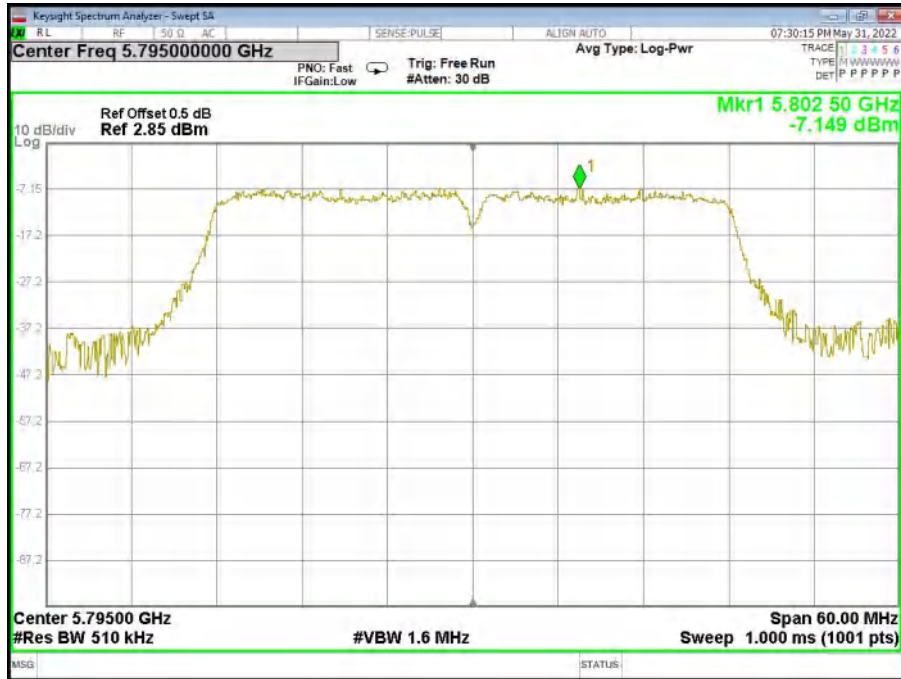

U-NII-3 802.11ac(H840) Low CH

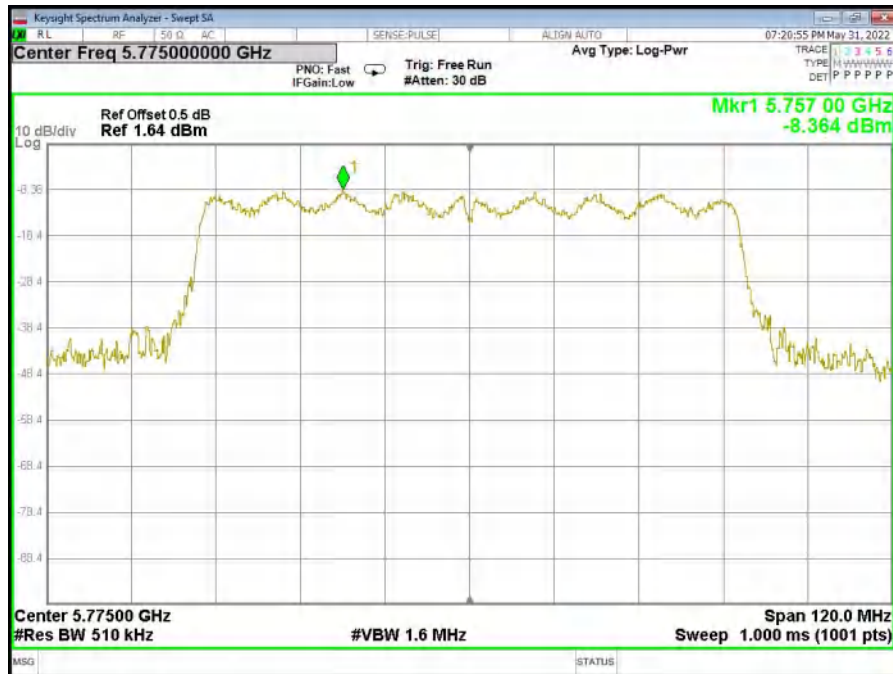



MIMO

U-NII-1 802.11a Low CH



U-NII-1 802.11a Middle CH



U-NII-1 802.11a High CH

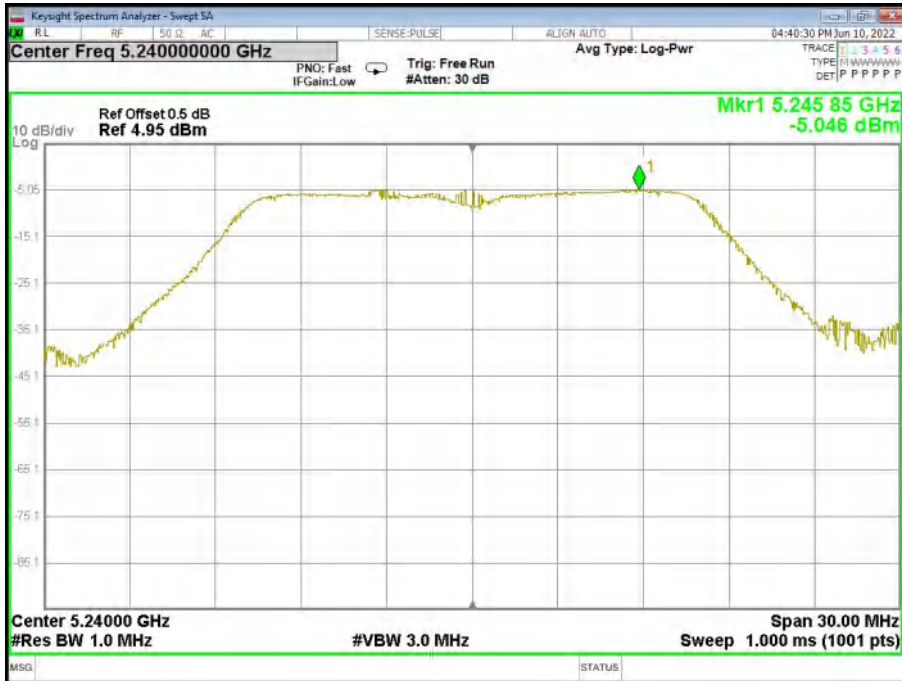

U-NII-1 802.11n(HT20) Low CH



U-NII-1 802.11n(HT20) Middle CH

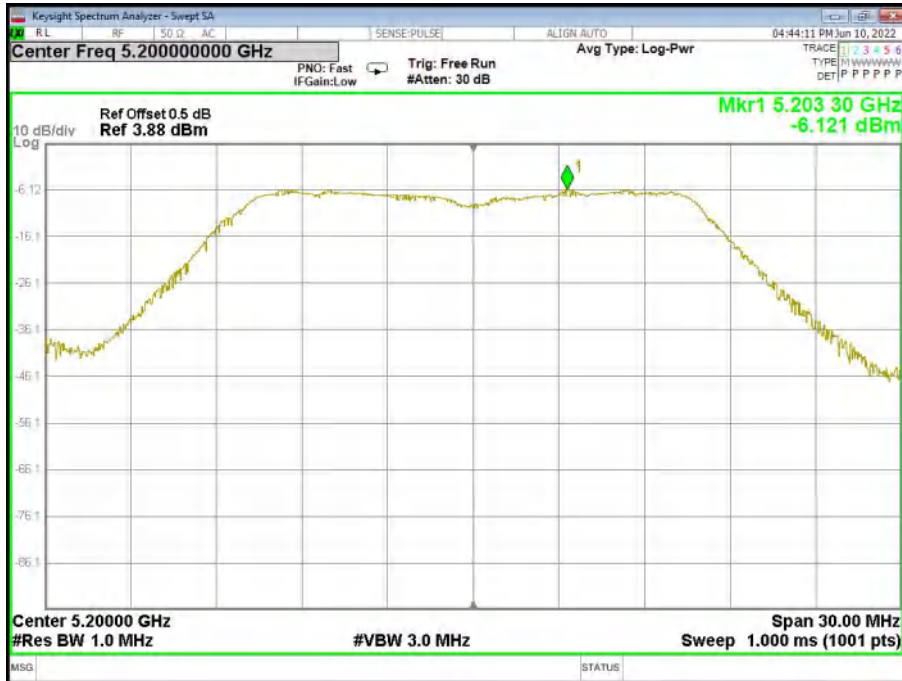

U-NII-1 802.11n(HT20) High CH

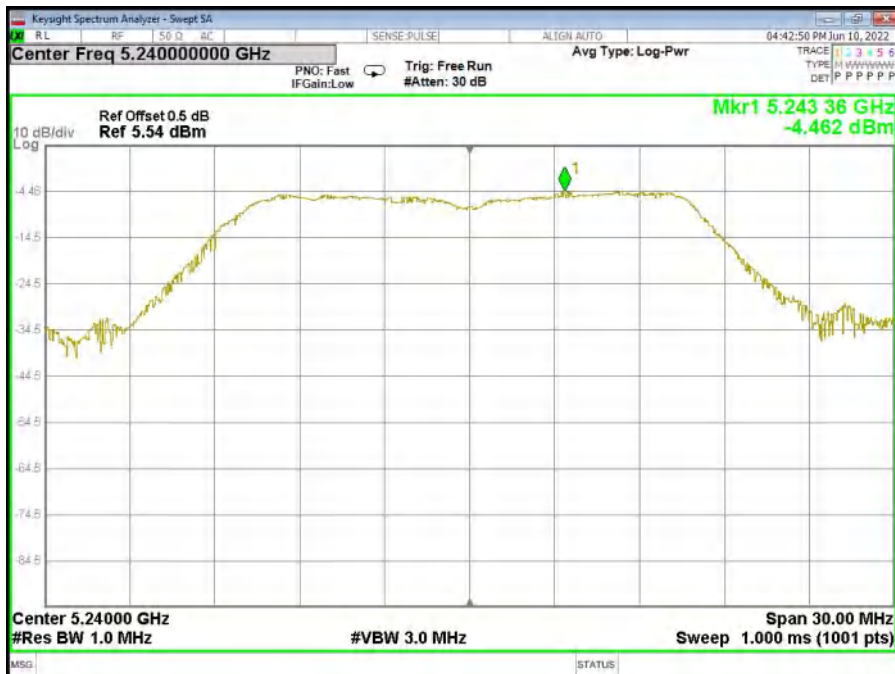

U-NII-1 802.11n(HT40) Low CH

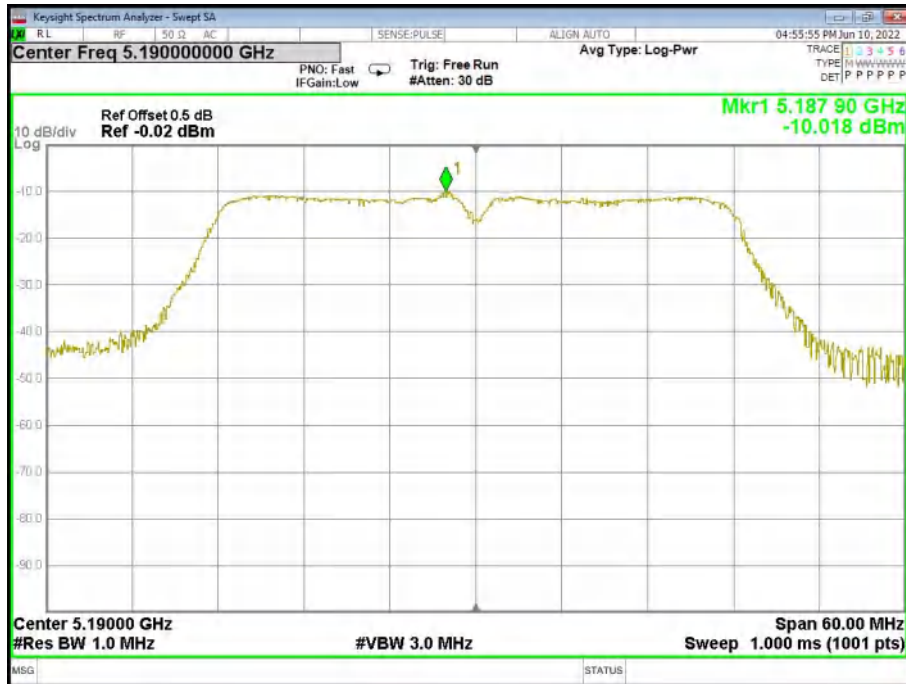

U-NII-1 802.11n(HT40) High CH

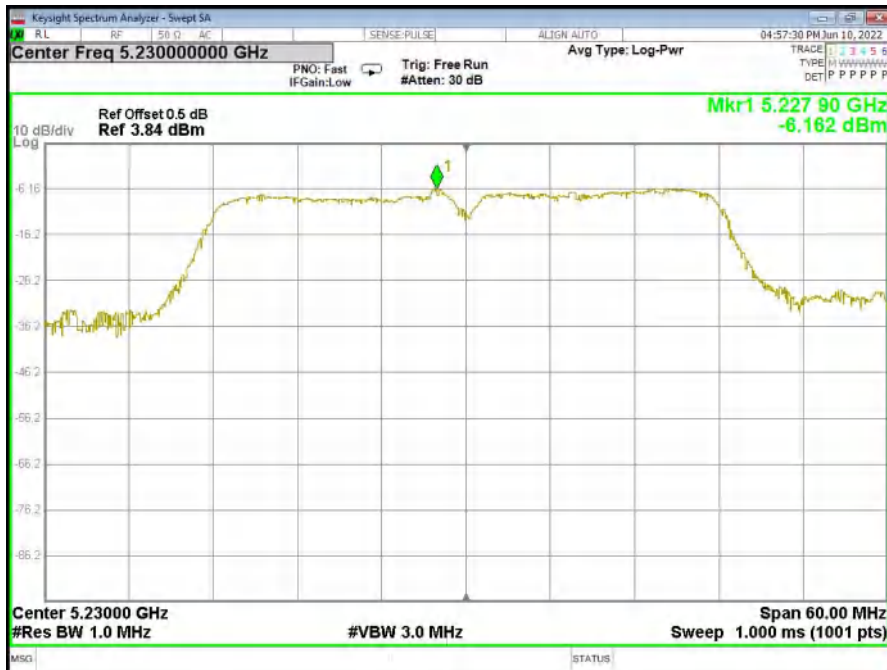

U-NII-1 802.11ac(HT20) Low CH



U-NII-1 802.11ac(HT20) Middle CH

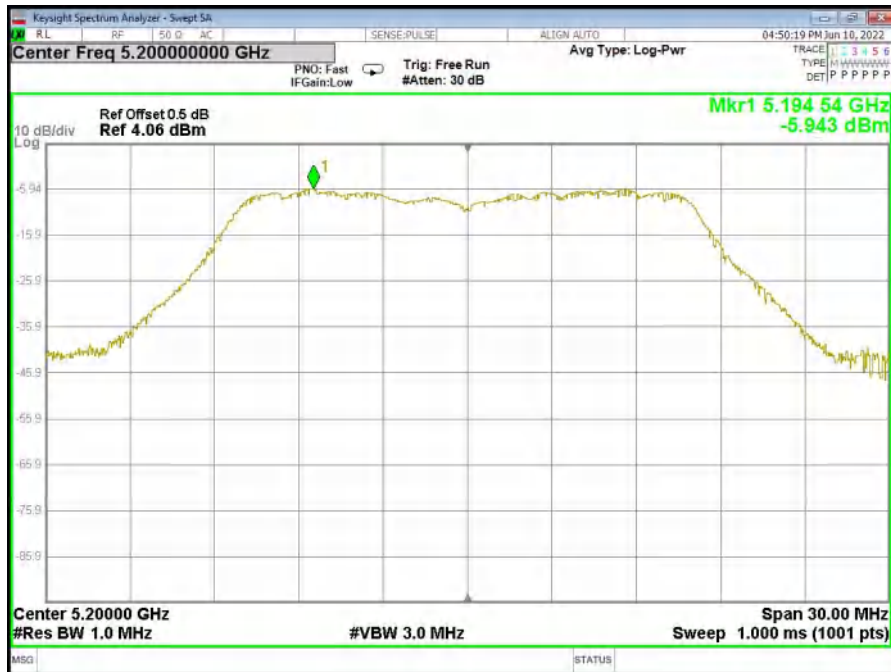

U-NII-1 802.11ac(HT20) High CH

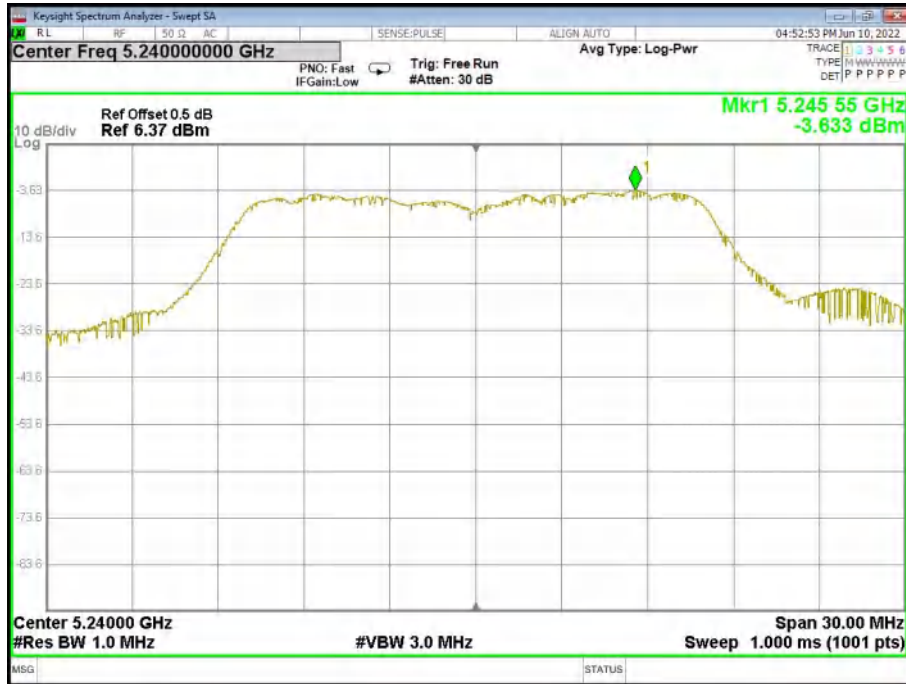

U-NII-1 802.11ac(HT40) Low CH

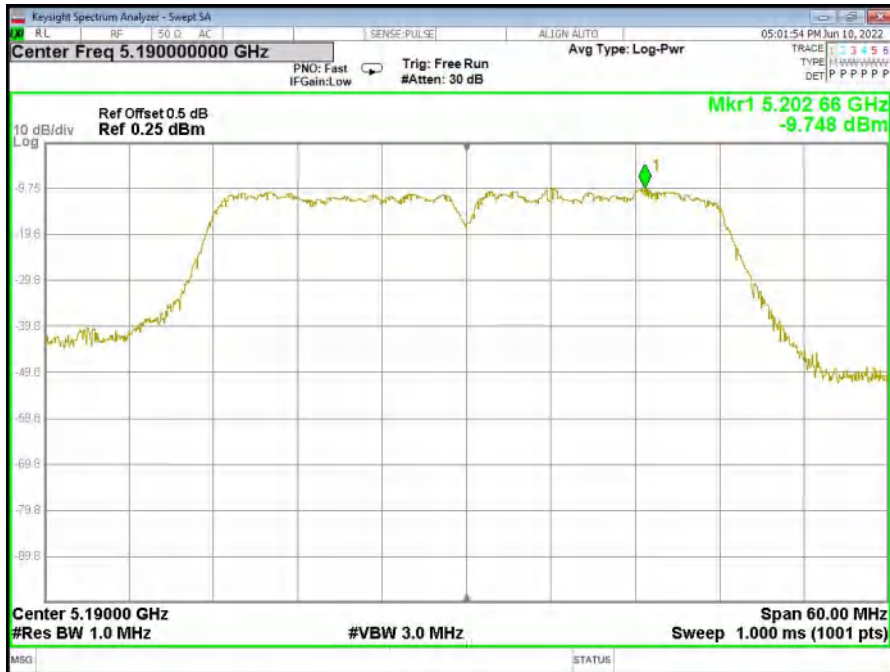

U-NII-1 802.11ac(HT40) High CH

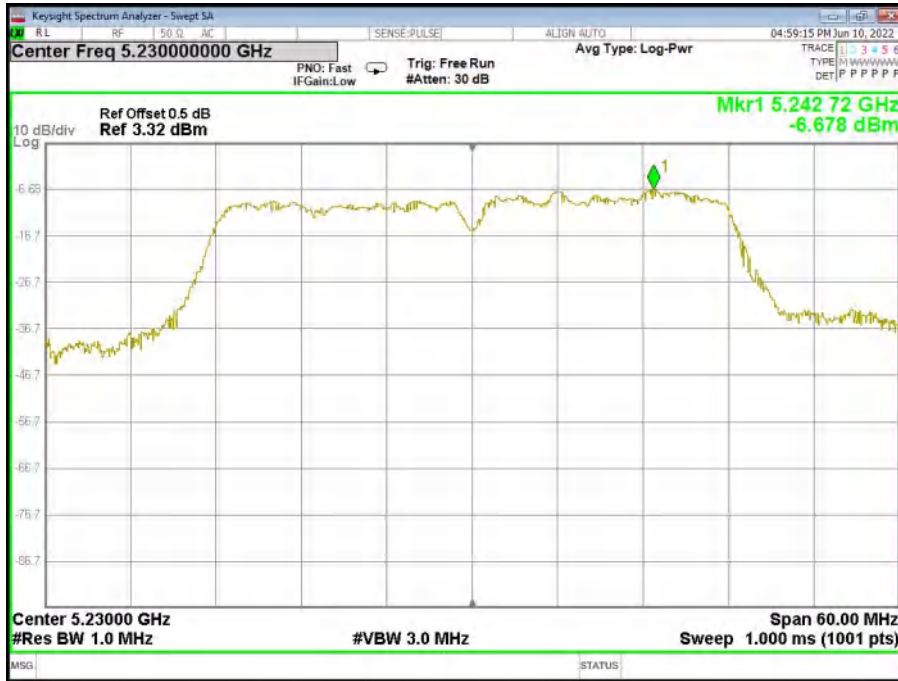

U-NII-1 802.11ac(HT80) Low CH

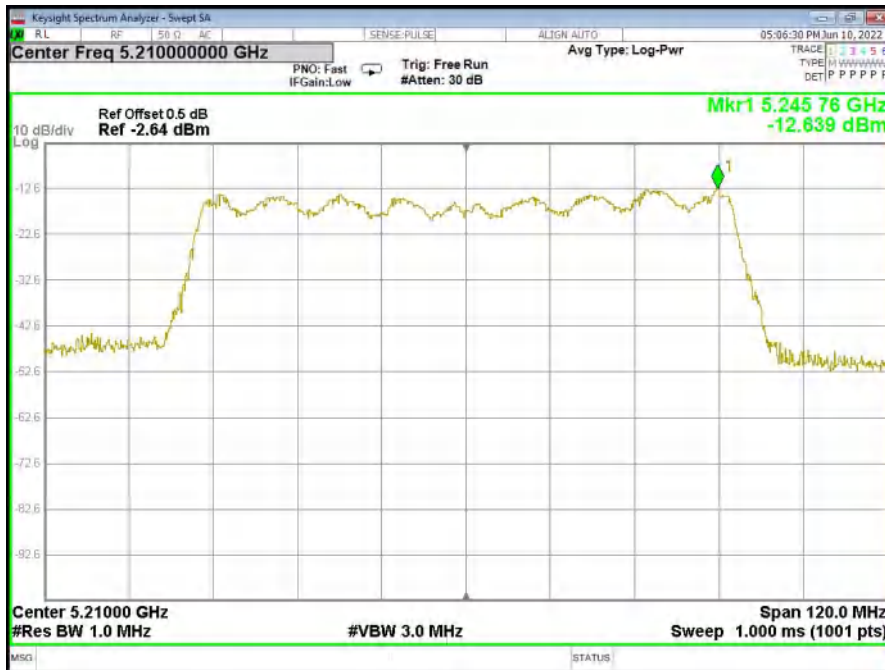

U-NII-3 802.11a Low CH



U-NII-3 802.11a Middle CH



U-NII-3 802.11a High CH



U-NII-3 802.11n(HT20) Low CH



U-NII-3 802.11n(HT20) Middle CH

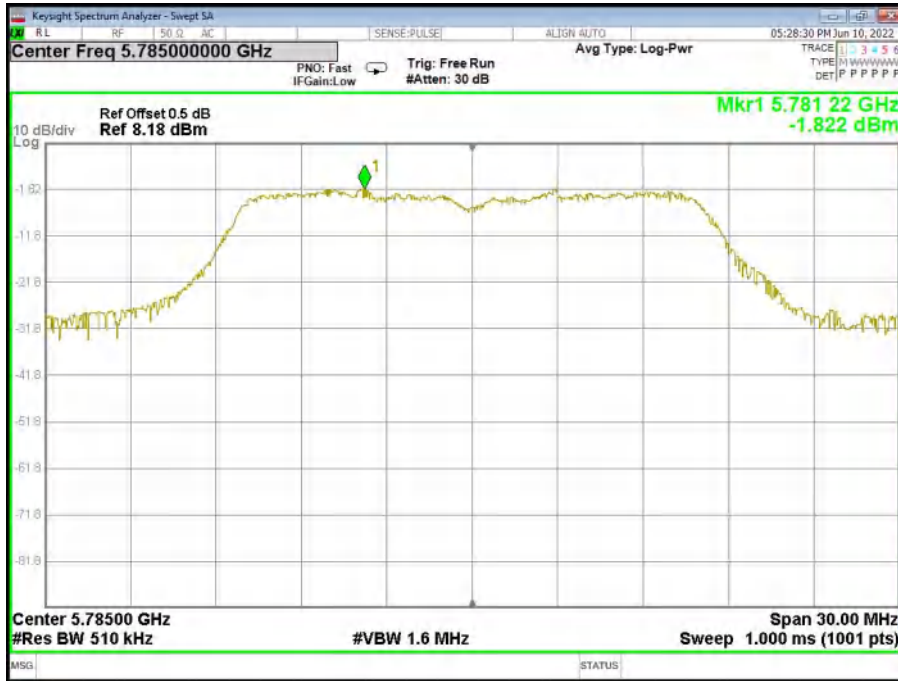

U-NII-3 802.11n(HT20) High CH

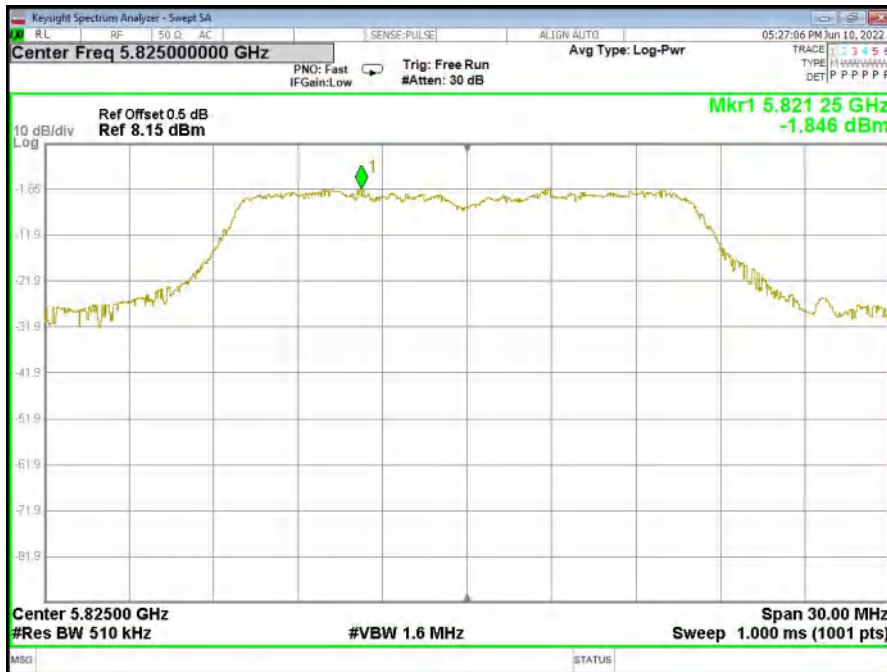

U-NII-3 802.11n(HT40) Low CH

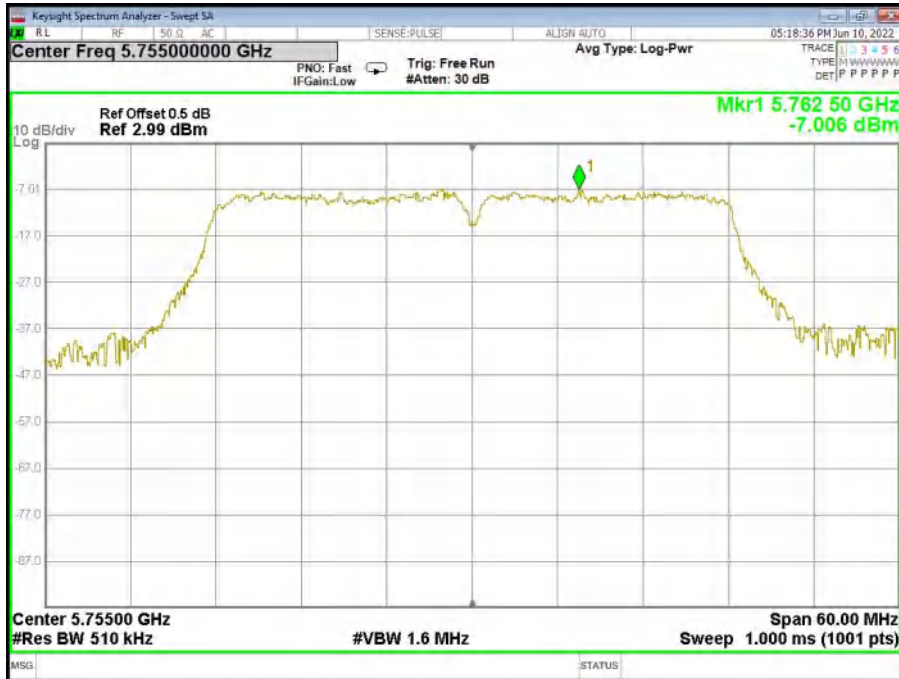

U-NII-3 802.11n(HT40) High CH



U-NII-3 802.11ac(HT20) Low CH



U-NII-3 802.11ac(HT20) Middle CH



U-NII-3 802.11ac(HT20) High CH

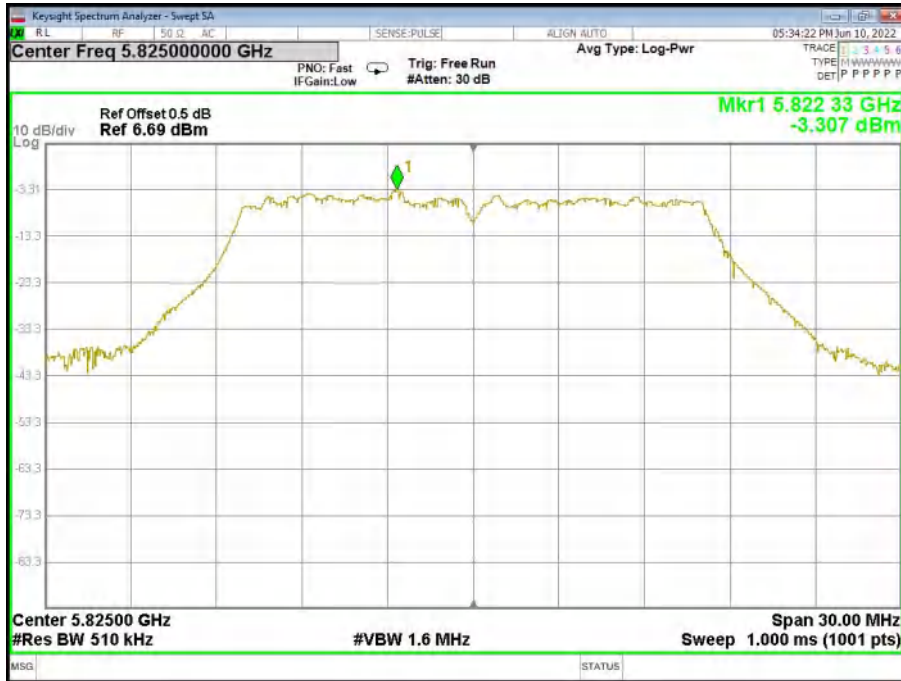

U-NII-3 802.11ac(HT40) Low CH



U-NII-3 802.11ac(HT40) High CH

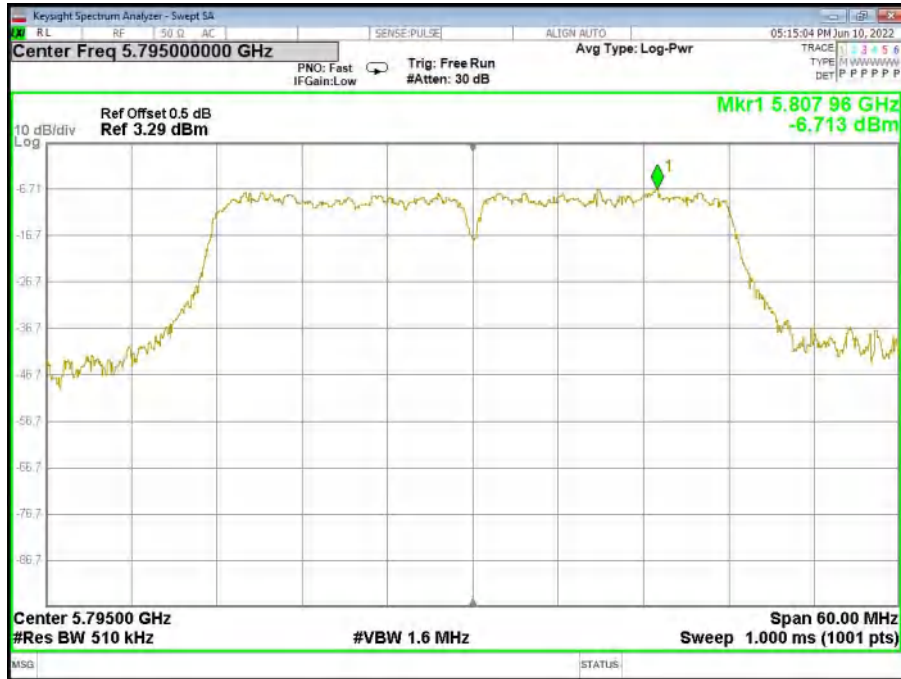

U-NII-3 802.11ac(H840) Low CH

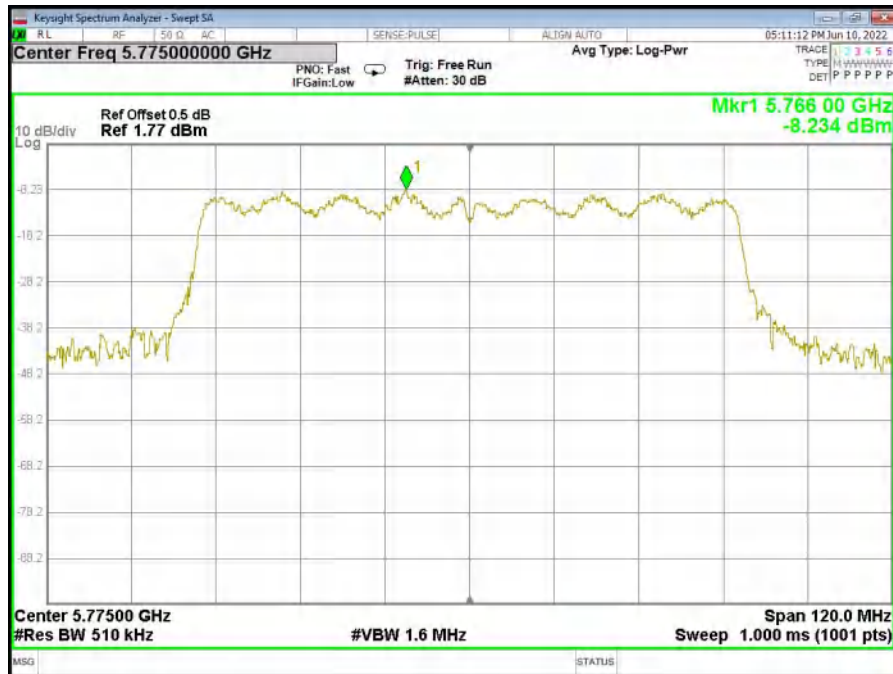

6. FREQUENCY STABILITY MEASUREMENT

6.1 LIMIT

Manufacturers of U-NII devices are responsible for ensuring frequency stability such that an emission is maintained within the band of operation under all conditions of normal operation as specified in the user's manual

6.2 TEST PROCEDURE

- (1) To ensure emission at the band edge is maintained within the authorized band, those values shall be measured by radiation emissions at upper and lower frequency points, and finally compensated by frequency deviation as procedures below.
- (2) The EUT was operated at the maximum output power, and connected to the spectrum analyzer, which is set to maximum hold function and peak detector. The peak value of the power envelope was measured and noted. The upper and lower frequency points were respectively measured relatively 10dB lower than the measured peak value.
- (3) The frequency deviation was calculated by adding the upper frequency point and the lower frequency point divided by two. Those detailed values of frequency deviation are provided in table below.

6.3 TEST SETUP

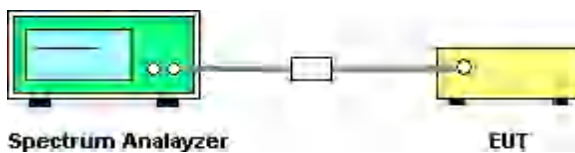

6.4 TEST RESULTS

U-NII-1 Test Frequency:5180MHz				
Temperature (°C)	Power Supply (DC)	Frequency Error (Hz)	Frequency Error (ppm)	Limit (ppm)
50	5.0 V	/	/	/
45		1807	2.1599	20
30		1800	2.1516	20
20		1806	2.1587	20
10		1800	2.1516	20
0		1803	2.1552	20
-10		1800	2.1516	20
-15		1809	2.1623	20
-30		/	/	/
20		4.5 V	1810	2.1635
20	5.5 V	1798	2.1492	20

U-NII-3 Test Frequency:5785MHz				
Temperature (°C)	Power Supply (DC)	Frequency Error (Hz)	Frequency Error (ppm)	Limit (ppm)
50	5.0 V	/	/	/
45		1919	2.2938	20
30		1911	2.2842	20
20		1915	2.2890	20
10		1923	2.2986	20
0		1907	2.2795	20
-10		1908	2.2807	20
-15		1914	2.2878	20
-30		/	/	/
20		4.5 V	1918	2.2926
20	5.5 V	1906	2.2783	20

7. Conducted spurious emission and Band edge

7.1 LIMIT

Undesirable emission limits. Except as shown in paragraph (b)(7) of this section, the maximum emissions outside of the frequency bands of operation shall be attenuated in accordance with the following limits:

Frequency Band (MHz)	Limit
5150 - 5250	Outside of the 5.15-5.35 GHz band; e.i.r.p. -27 dBm
5250 - 5350	Outside of the 5.15-5.35 GHz band; e.i.r.p. -27 dBm
5470 - 5725	Outside of the 5.47-5.725 GHz band; e.i.r.p. -27 dBm
5725 - 5850	All emissions shall be limited to a level of -27 dBm/MHz at 75 MHz or more above or below the band edge increasing linearly to 10 dBm/MHz at 25 MHz above or below the band edge, and from 25 MHz above or below the band edge increasing linearly to a level of 15.6 dBm/MHz at 5 MHz above or below the band edge, and from 5 MHz above or below the band edge increasing linearly to a level of 27 dBm/MHz at the band edge.

7.2 TEST PROCEDURE

Use the following spectrum analyzer settings:
 Span = wide enough to capture the peak level of the in-band emission and all spurious emissions (e.g., harmonics) from the lowest frequency generated in the EUT up through the 10th harmonic. Typically, several plots are required to cover this entire span.
 RBW = 1 MHz for > 1 GHz, 100 kHz for < 1 GHz
 VBW > RBW
 Sweep = auto
 Detector function = peak
 Trace = max hold

Allow the trace to stabilize

7.3 TEST SETUP

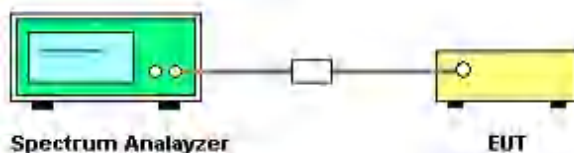

7.4 TEST RESULTS

7.5 Original test data

U-NII-1 802.11a left side

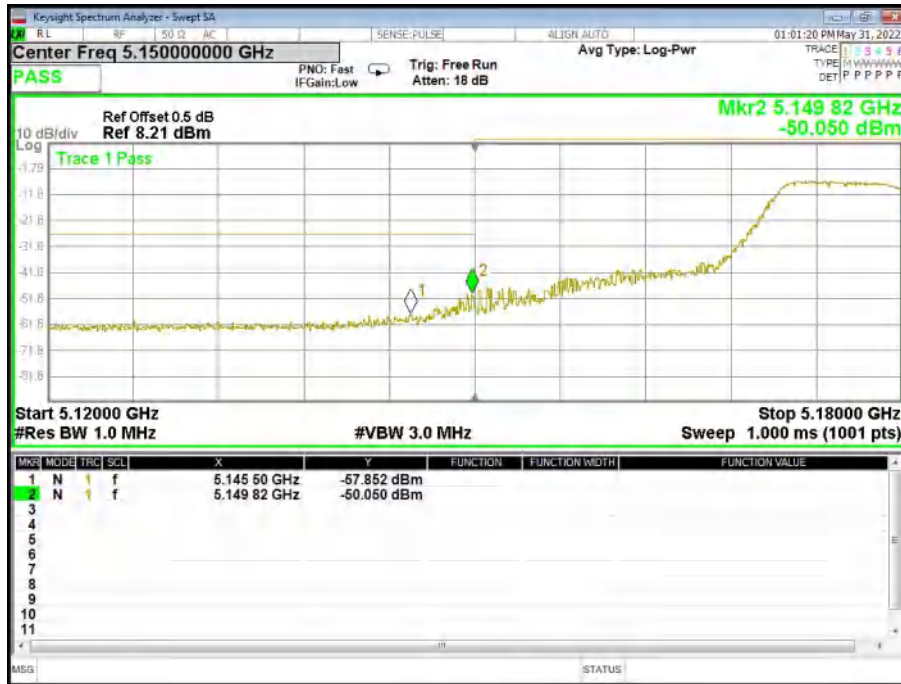

U-NII-1 802.11a Right side

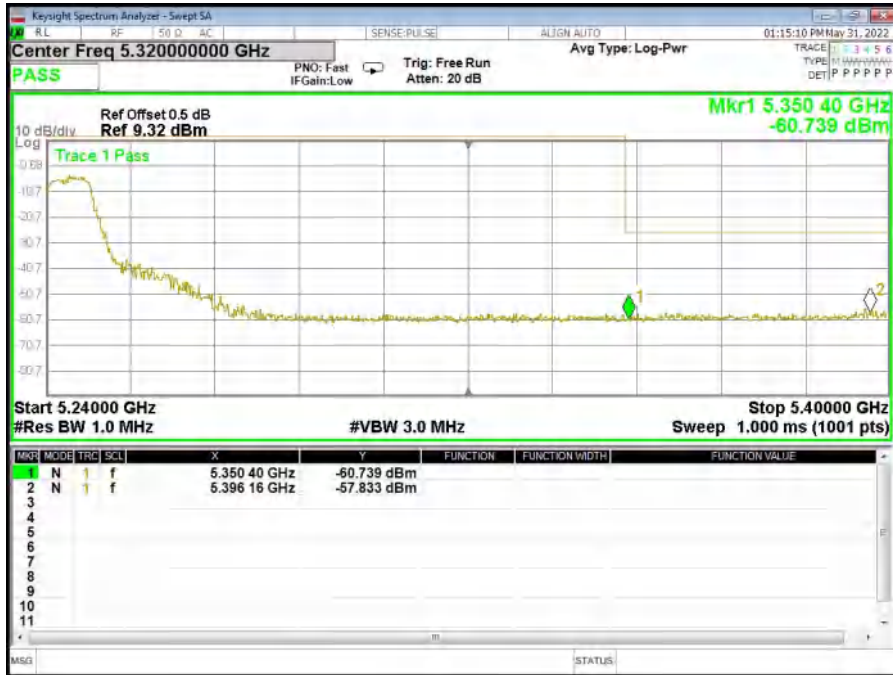

U-NII-3 802.11a left side



U-NII-3 802.11a right side



U-NII-1 802.11n(HT20) left side



U-NII-1 802.11n(HT20) Right side



U-NII-3 802.11n(HT20) left side



U-NII-3 802.11n(HT20) Right side



U-NII-1 802.11n(HT40) left side



U-NII-1 802.11n(HT40) Right side



U-NII-3 802.11n(HT40) left side

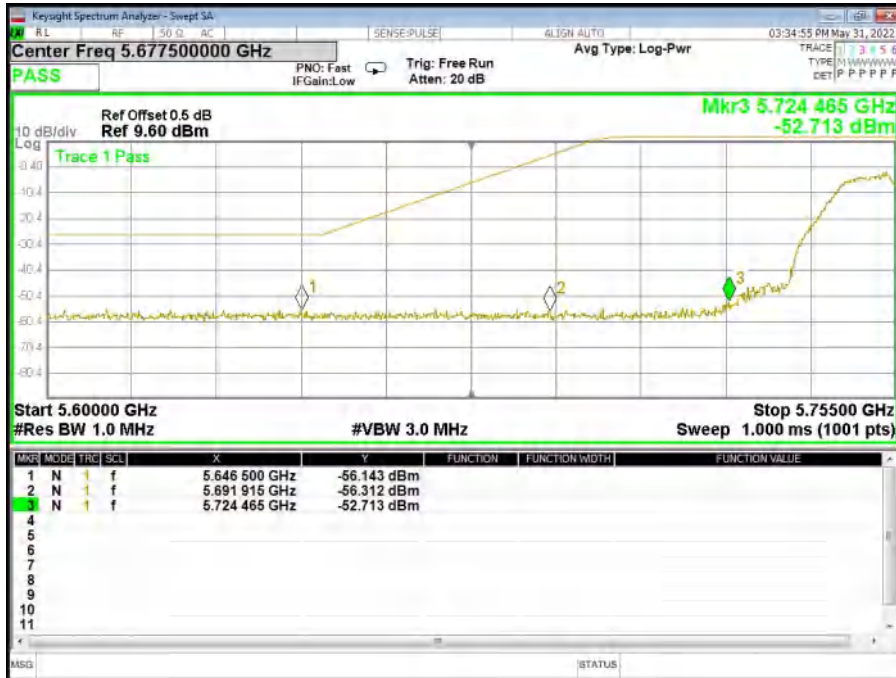

U-NII-3 802.11n(HT40) Right side

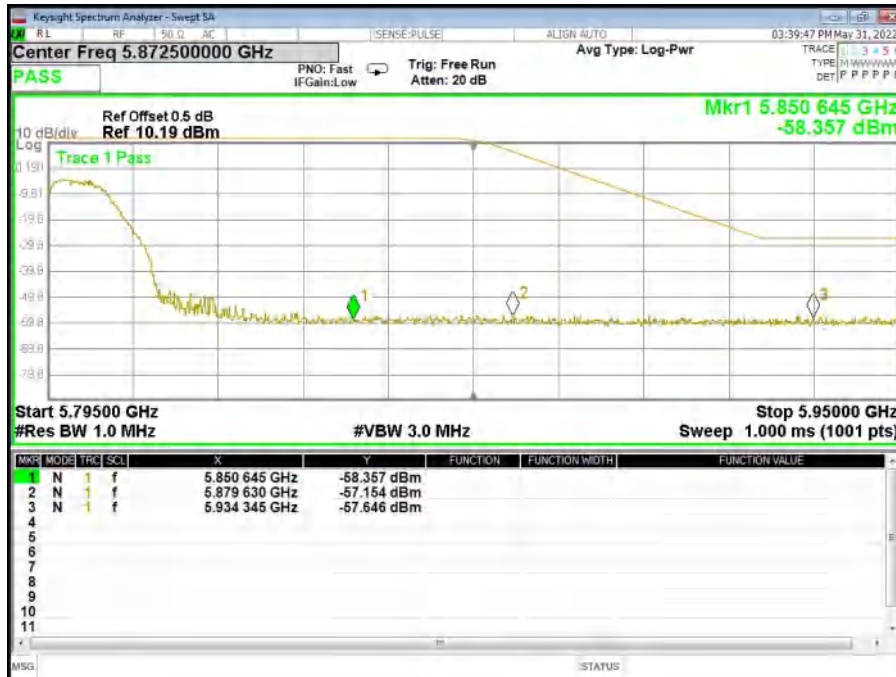

U-NII-1 802.11ac(HT20) left side



U-NII-1 802.11ac(HT20) Right side



U-NII-3 802.11ac(HT20) left side



U-NII-3 802.11ac(HT20) Right side



U-NII-1 802.11ac(HT40) left side

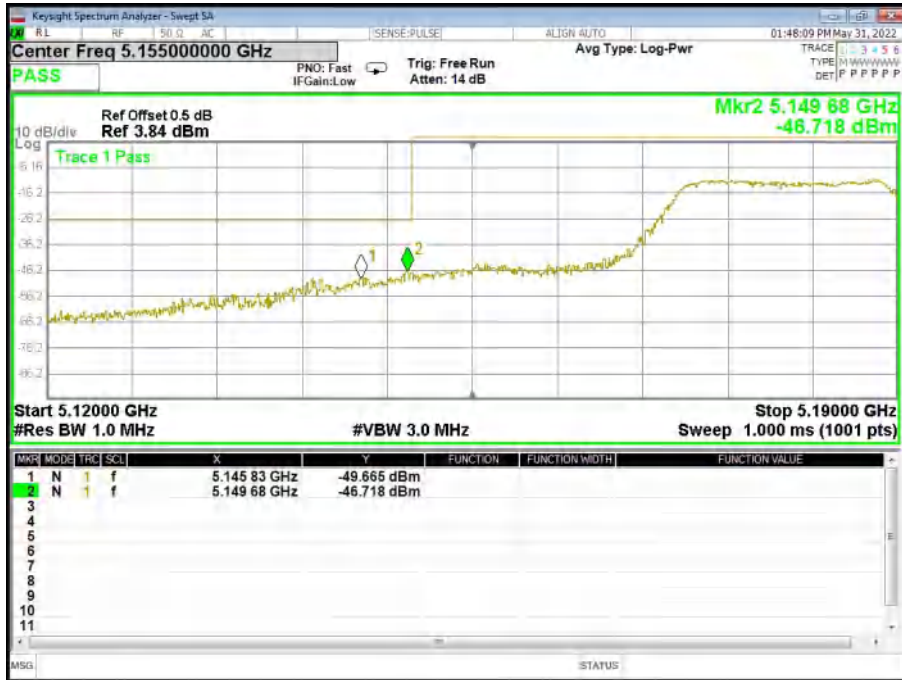

U-NII-1 802.11ac(HT40) Right side



U-NII-3 802.11ac(HT40) left side



U-NII-3 802.11ac(HT40) Right side



U-NII-1 802.11ac(HT80) left side



U-NII-1 802.11ac(HT80) Right side

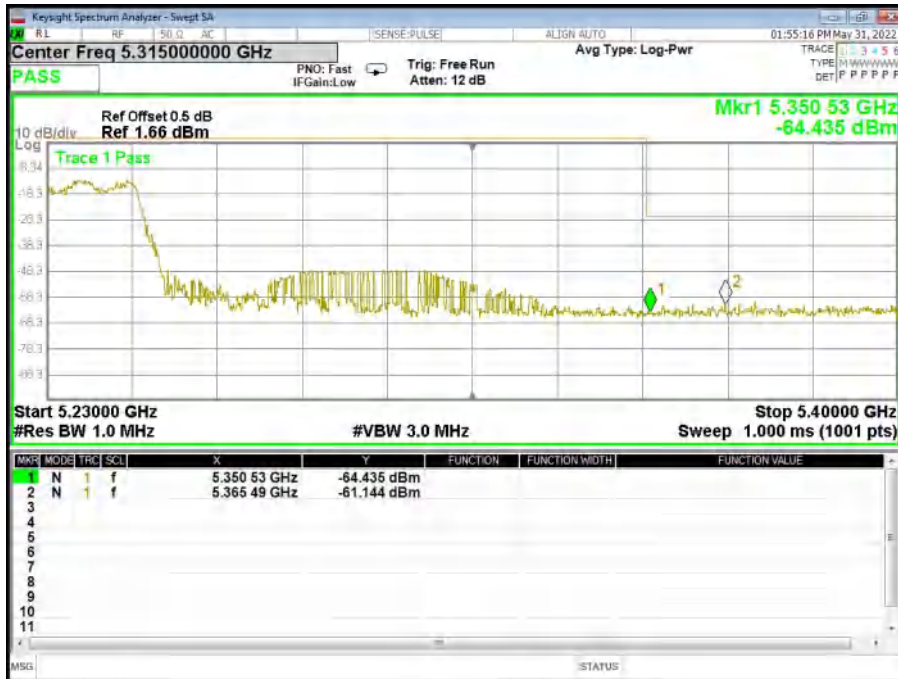

U-NII-3 802.11ac(HT80) left side



U-NII-3 802.11ac(HT80) Right side



conducted spurious

U-NII-1 802.11a Low CH

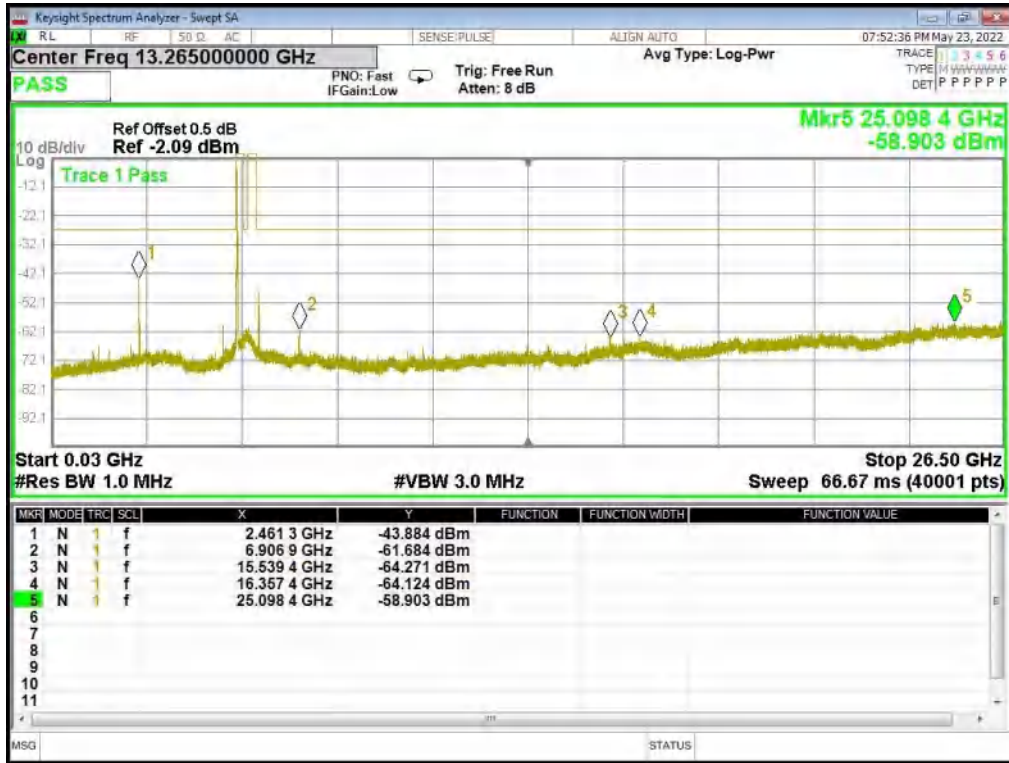

U-NII-1 802.11a Middle CH

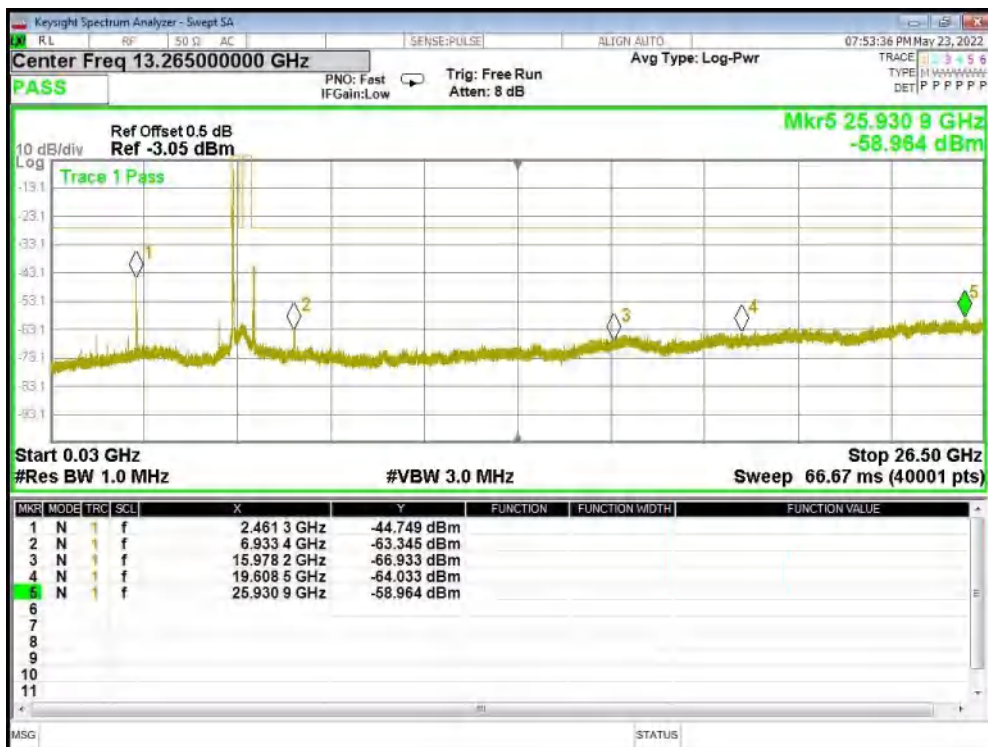

U-NII-1 802.11a High CH

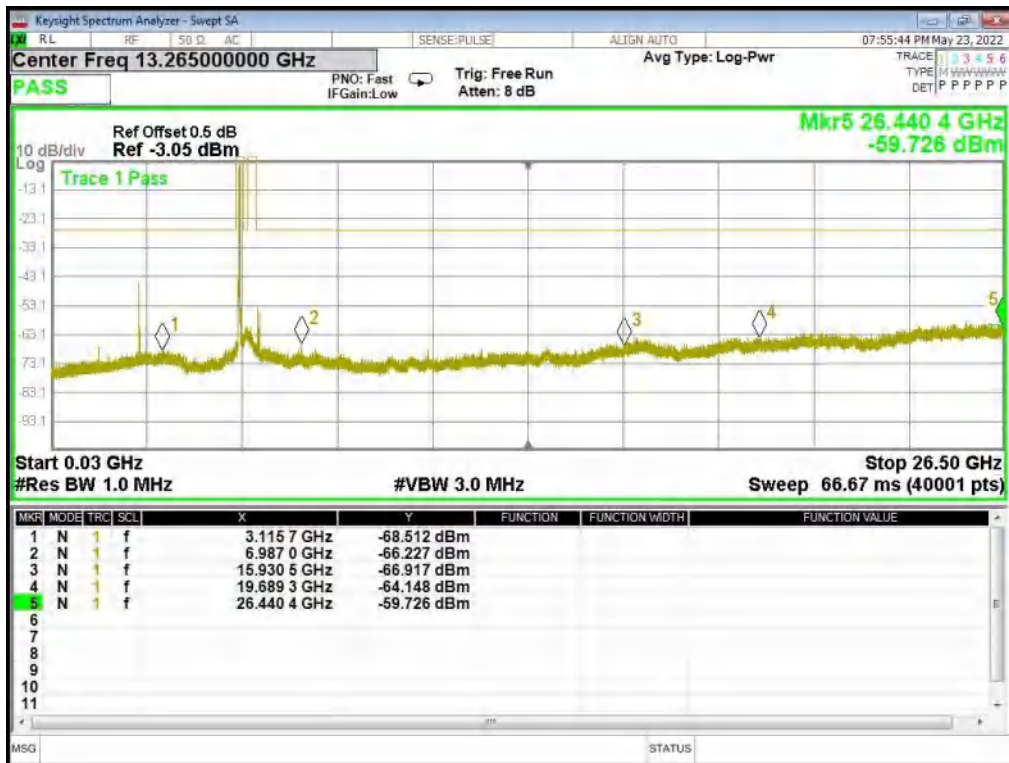

U-NII-1 802.11n(HT20) Low CH

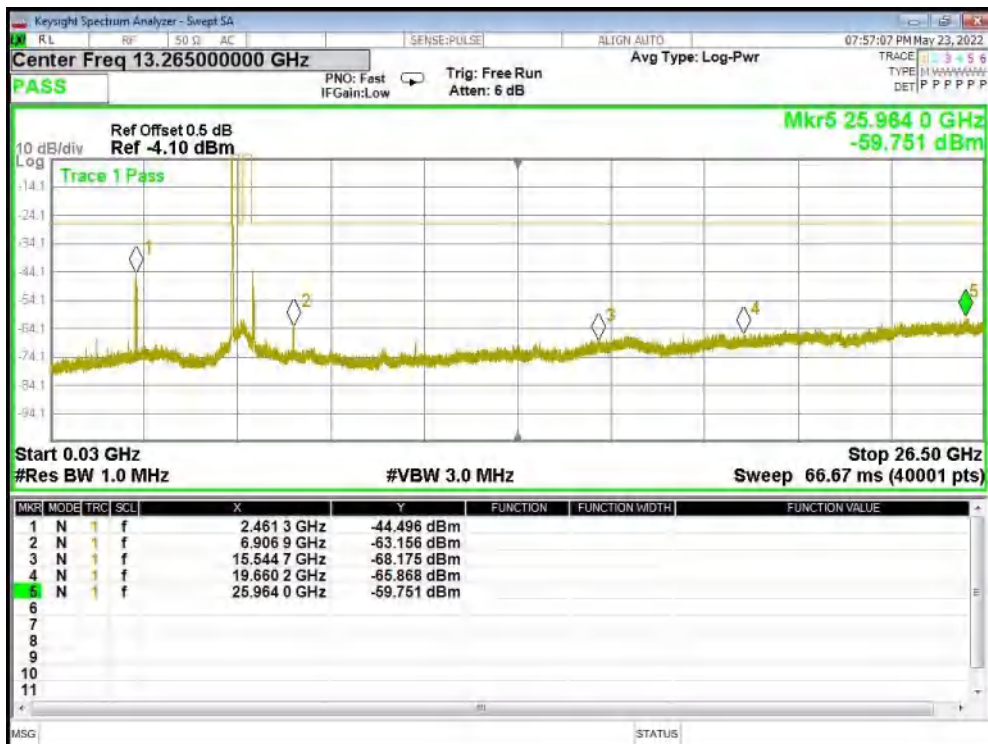

U-NII-1 802.11n(HT20) Middle CH

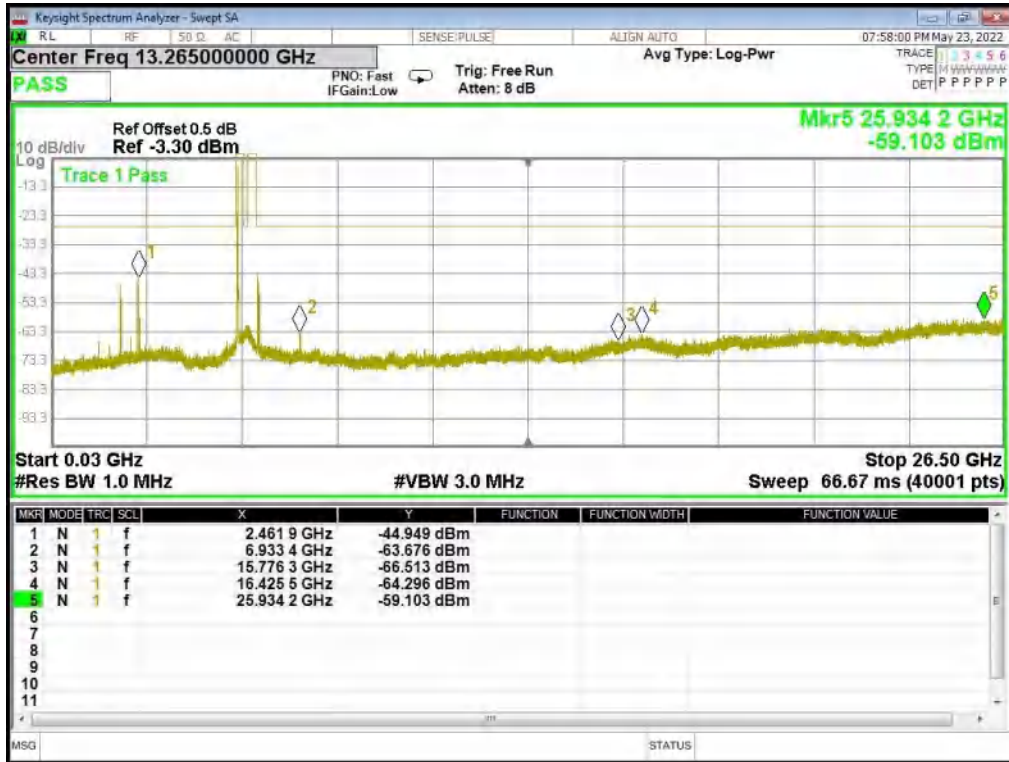

U-NII-1 802.11n(HT20) High CH

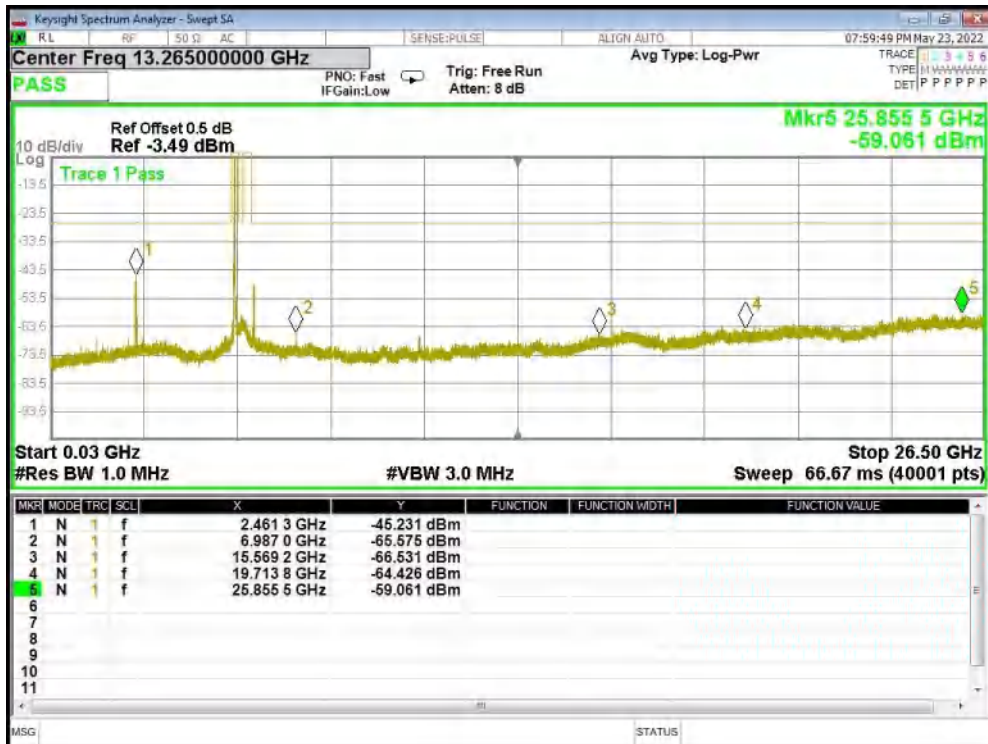

U-NII-1 802.11ac(HT20) Low CH

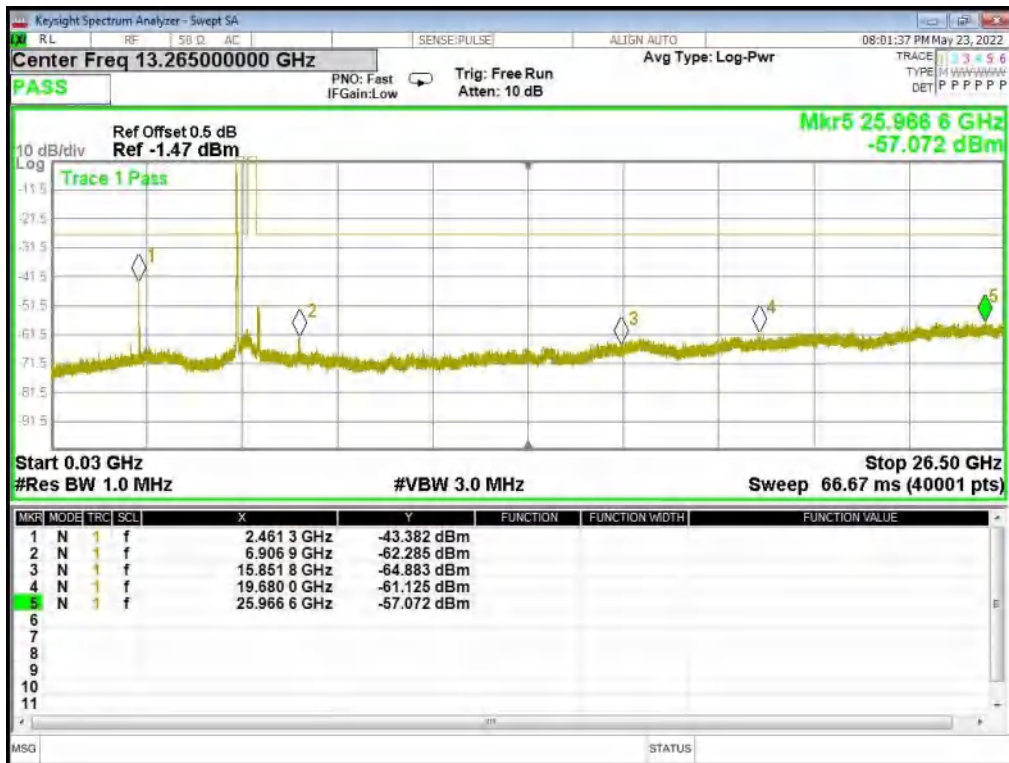

U-NII-1 802.11ac(HT20) Middle CH

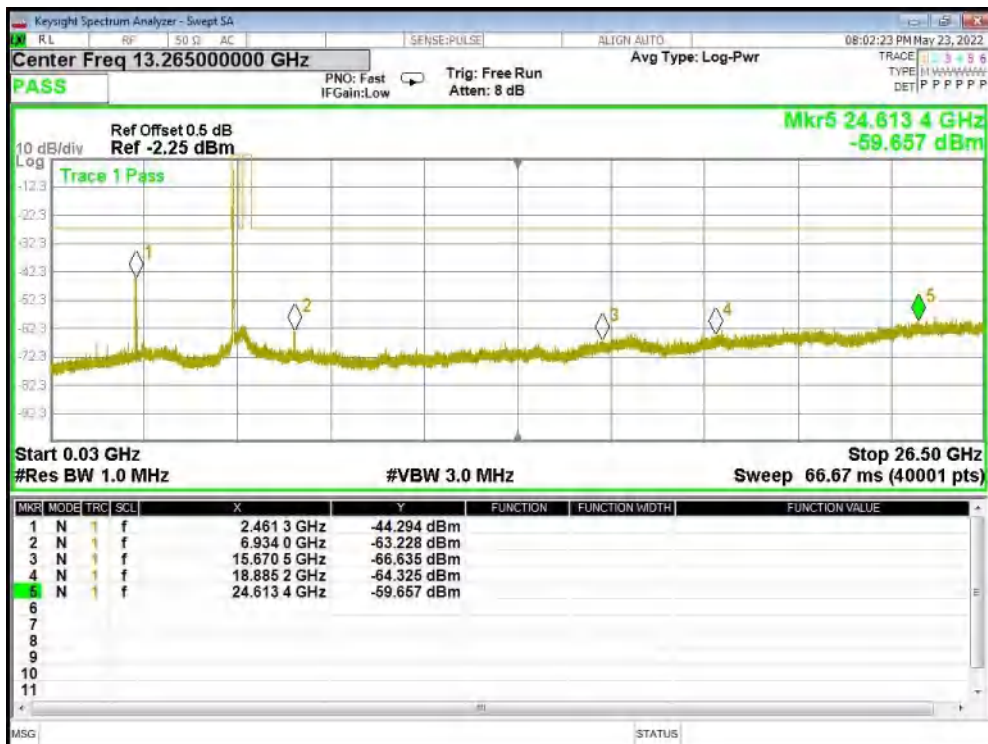

U-NII-1 802.11ac(HT20) High CH



U-NII-1 802.11n(HT40) Low CH

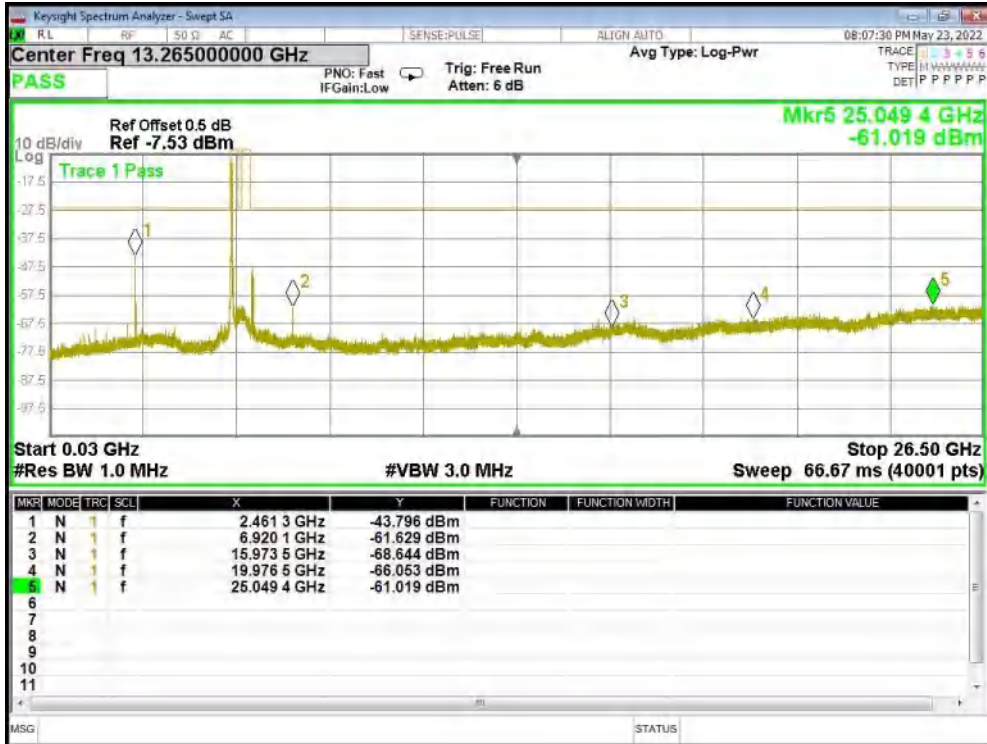

U-NII-1 802.11n(HT40) High CH

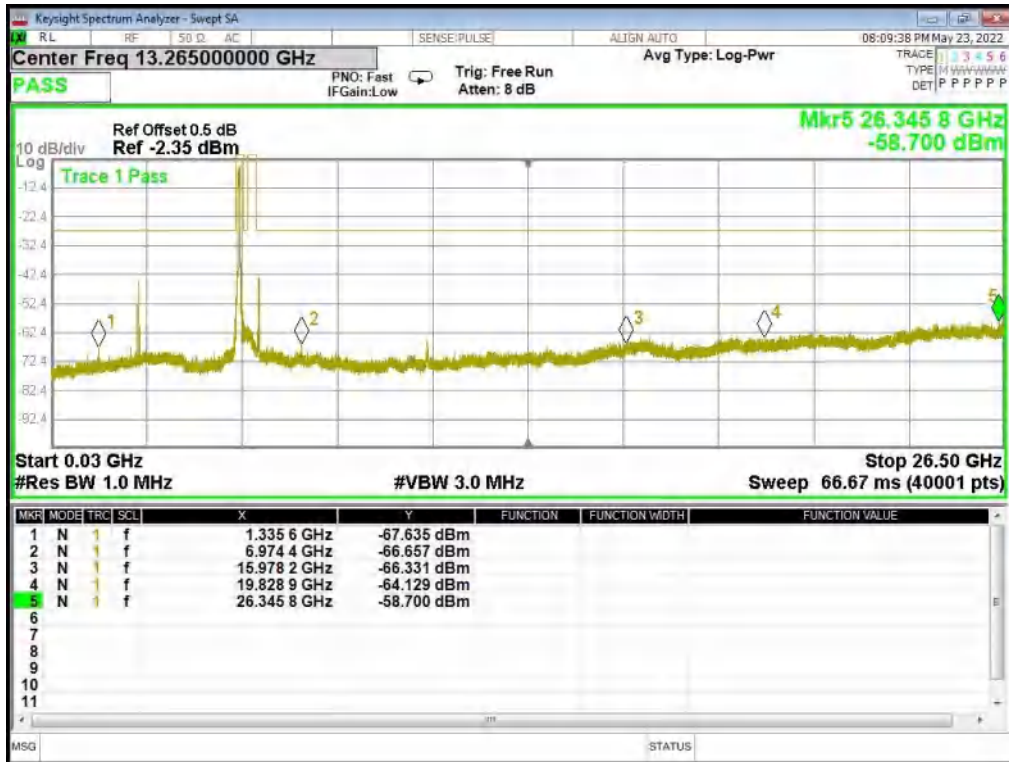

U-NII-1 802.11ac(HT40) Low CH



U-NII-1 802.11ac(HT40) High CH

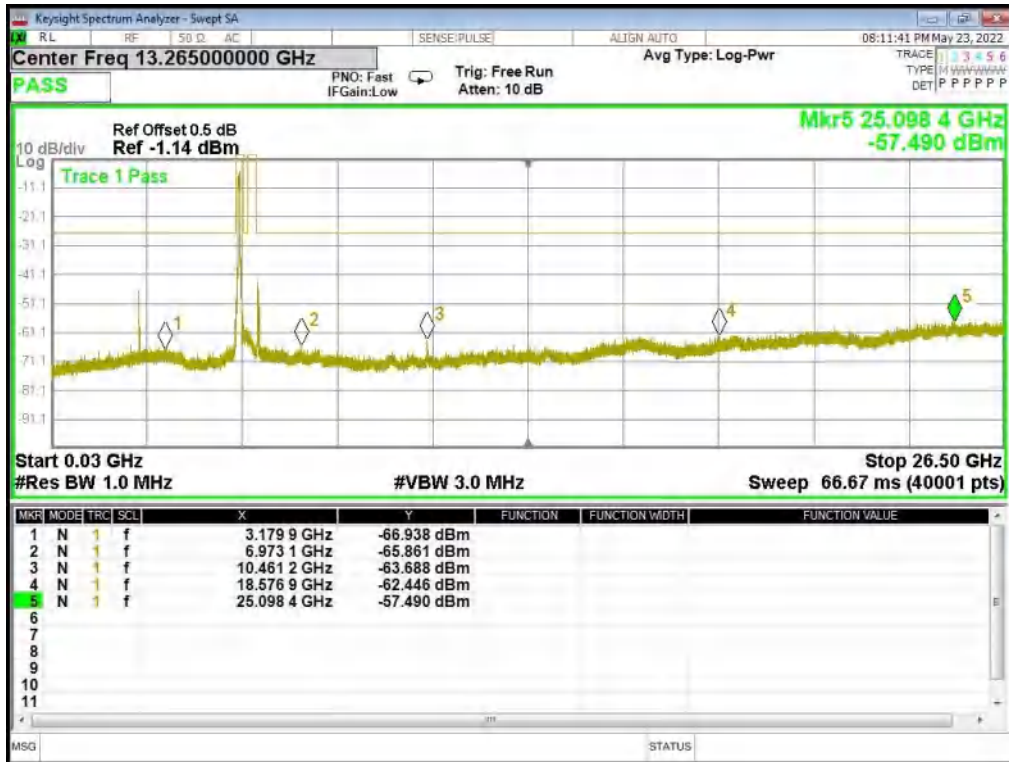

U-NII-1 802.11ac(HT80) Middle CH

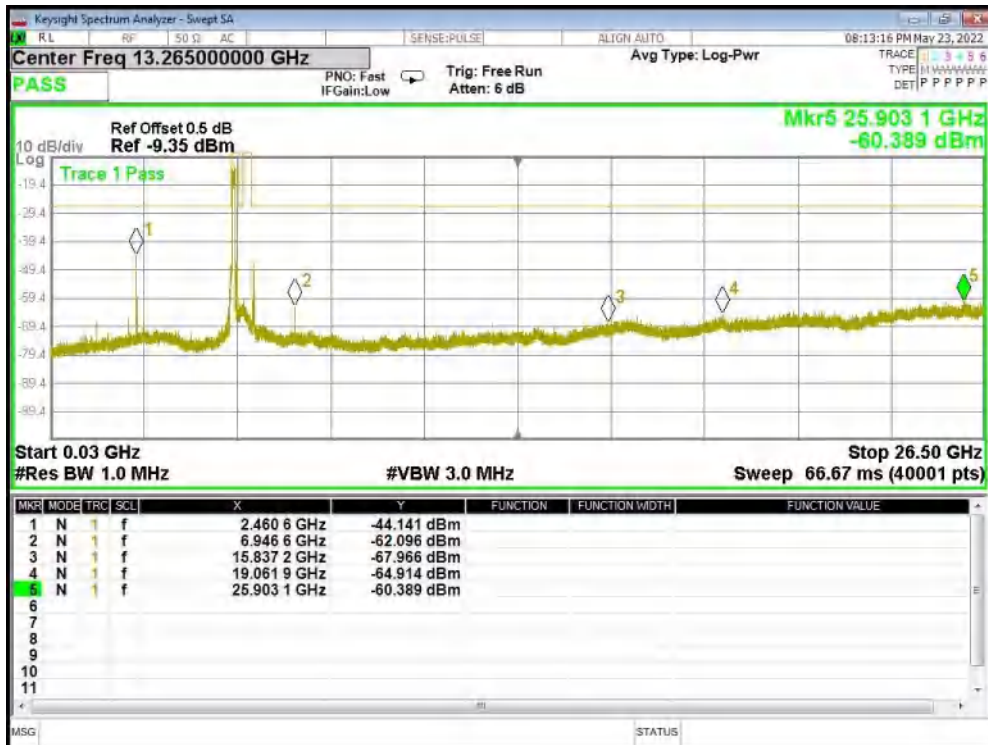

U-NII-3 802.11a Low CH



U-NII-3 802.11a Middle CH

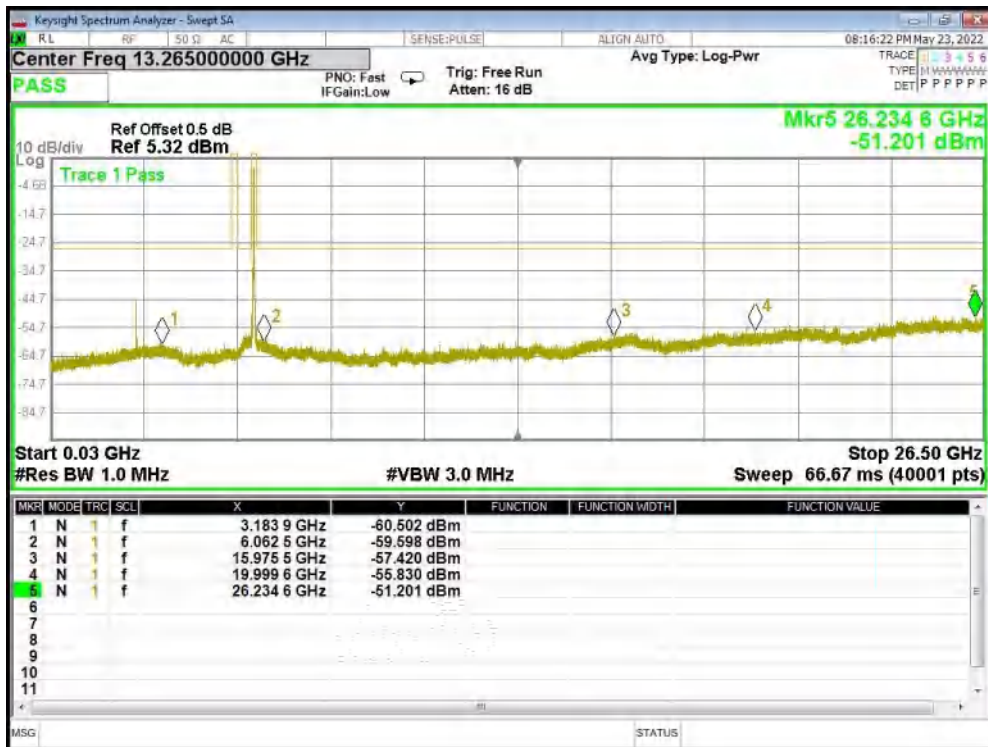

U-NII-3 802.11a High CH

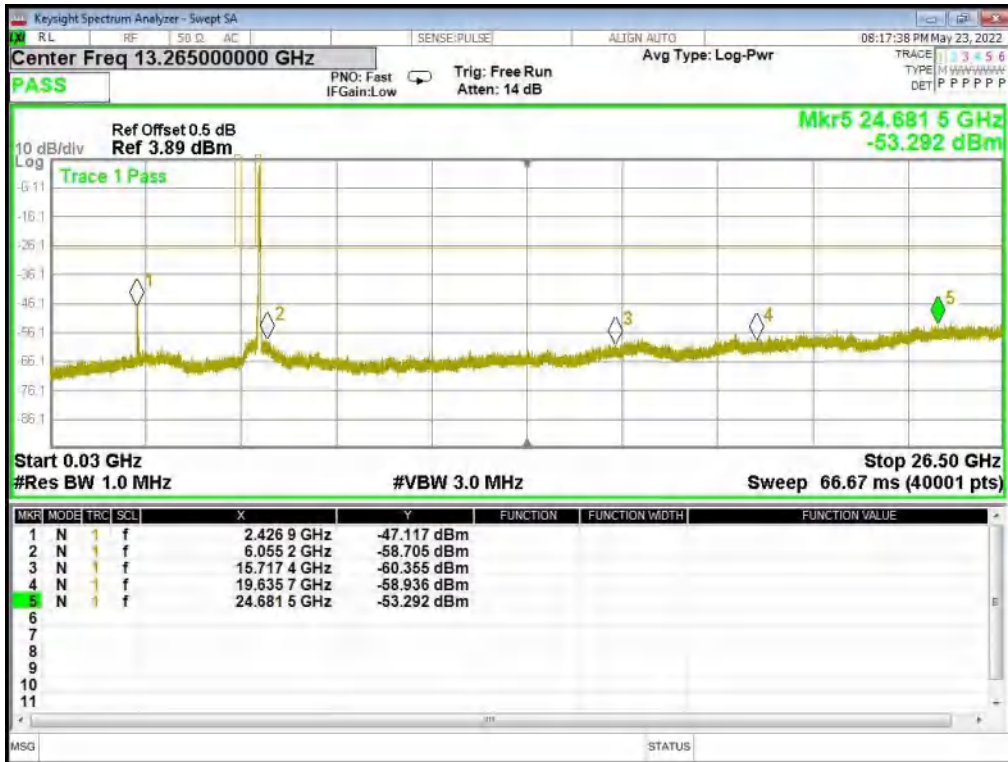

U-NII-3 802.11n(HT20) Low CH

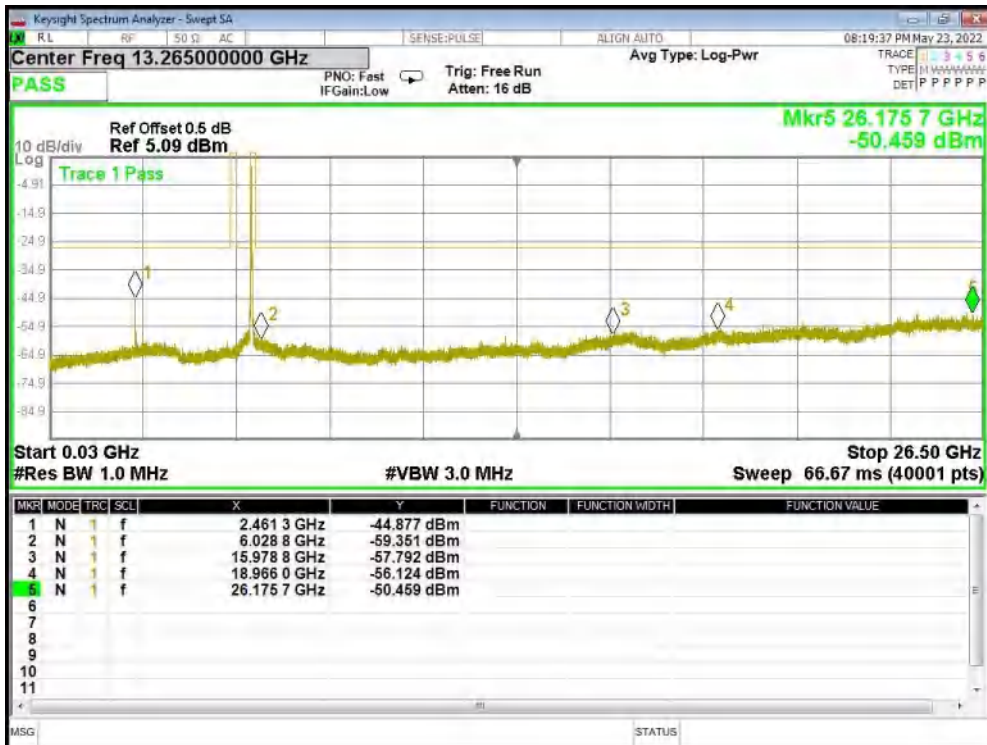

U-NII-3 802.11n(HT20) Middle CH

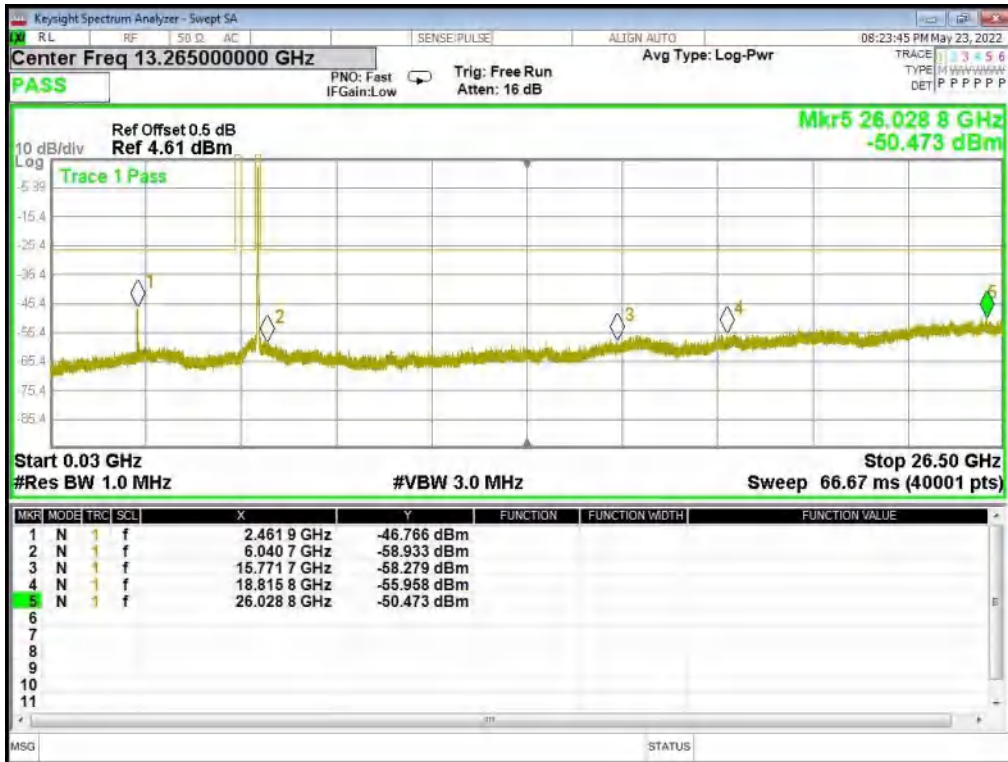

U-NII-3 802.11n(HT20) High CH

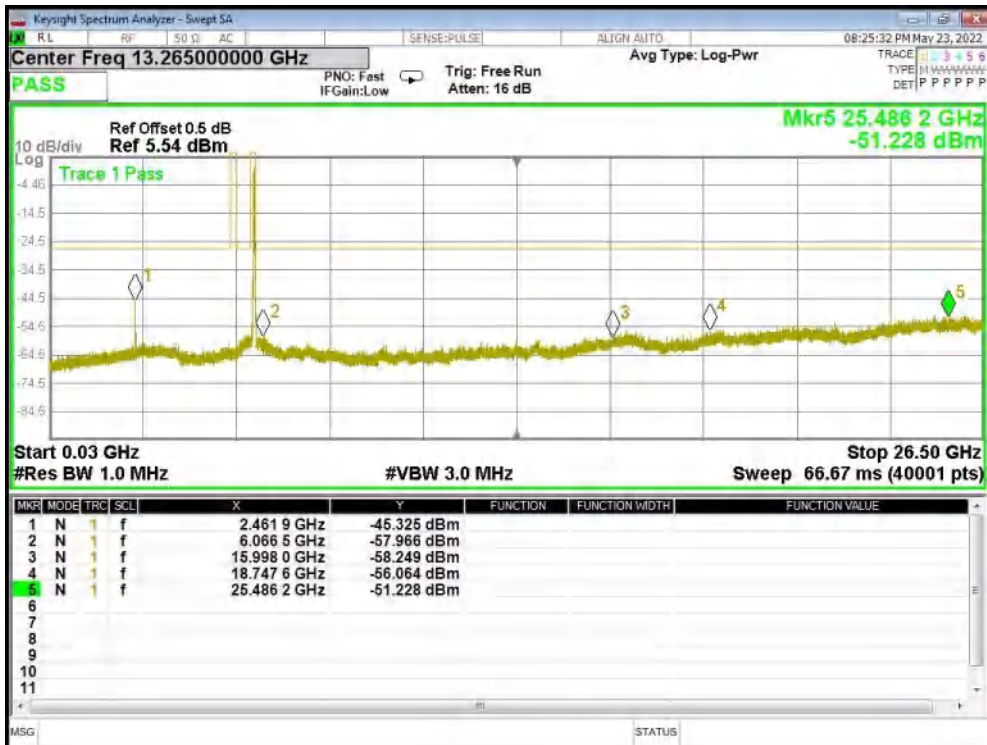

U-NII-3 802.11ac(HT20) Low CH



U-NII-3 802.11ac(HT20) Middle CH

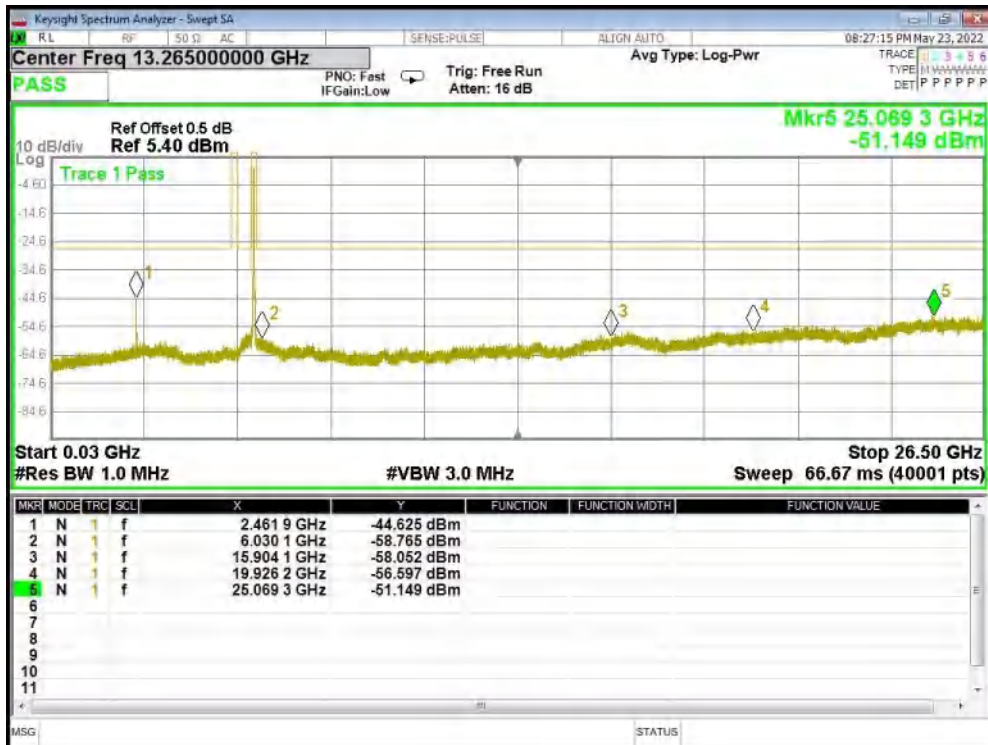

U-NII-3 802.11ac(HT20) High CH



U-NII-3 802.11n(HT40) Low CH



U-NII-3 802.11n(HT40) High CH

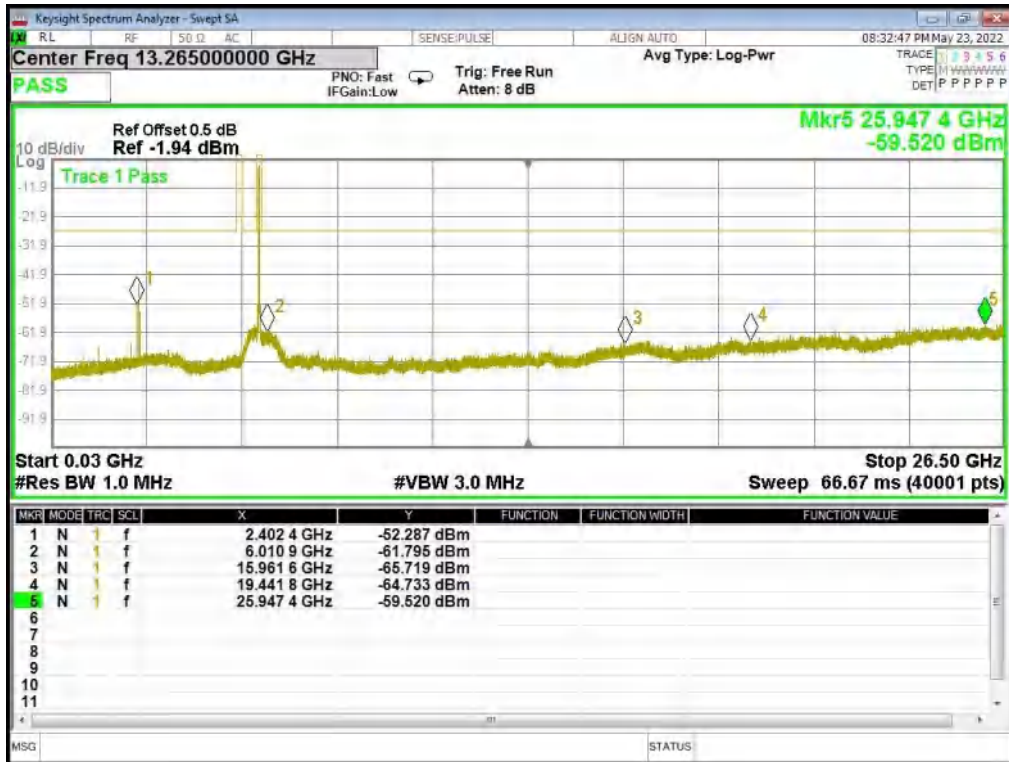

U-NII-3 802.11ac(HT40) Low CH



U-NII-3 802.11ac(HT40) High CH

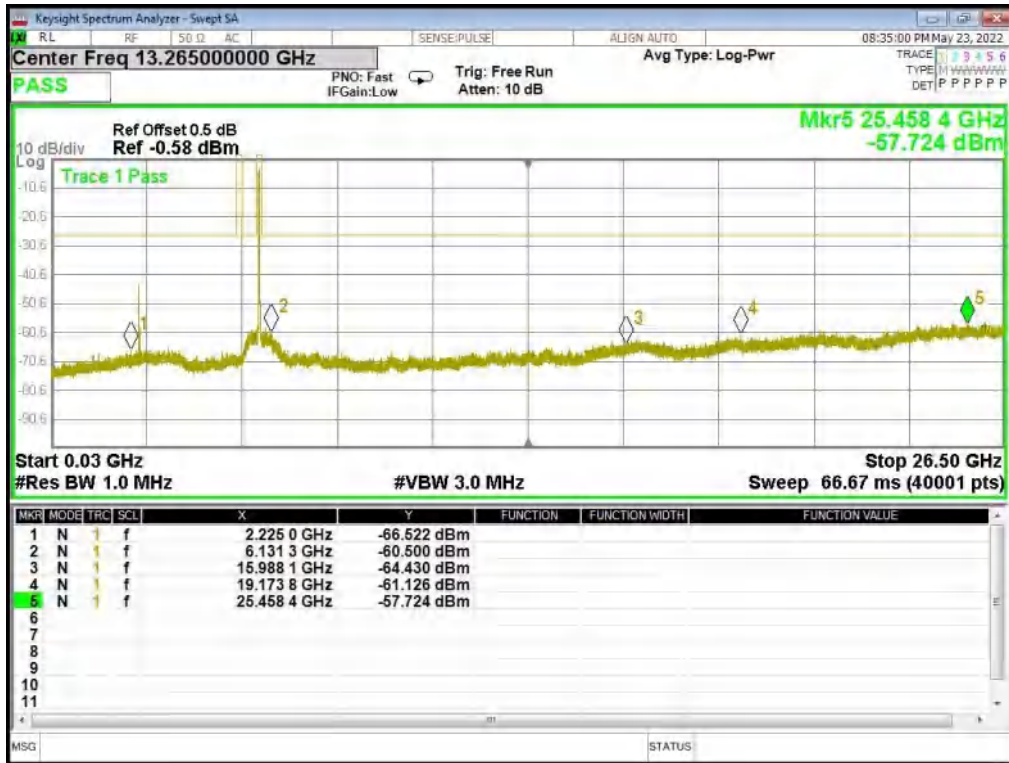

U-NII-3 802.11ac(HT80) Middle CH

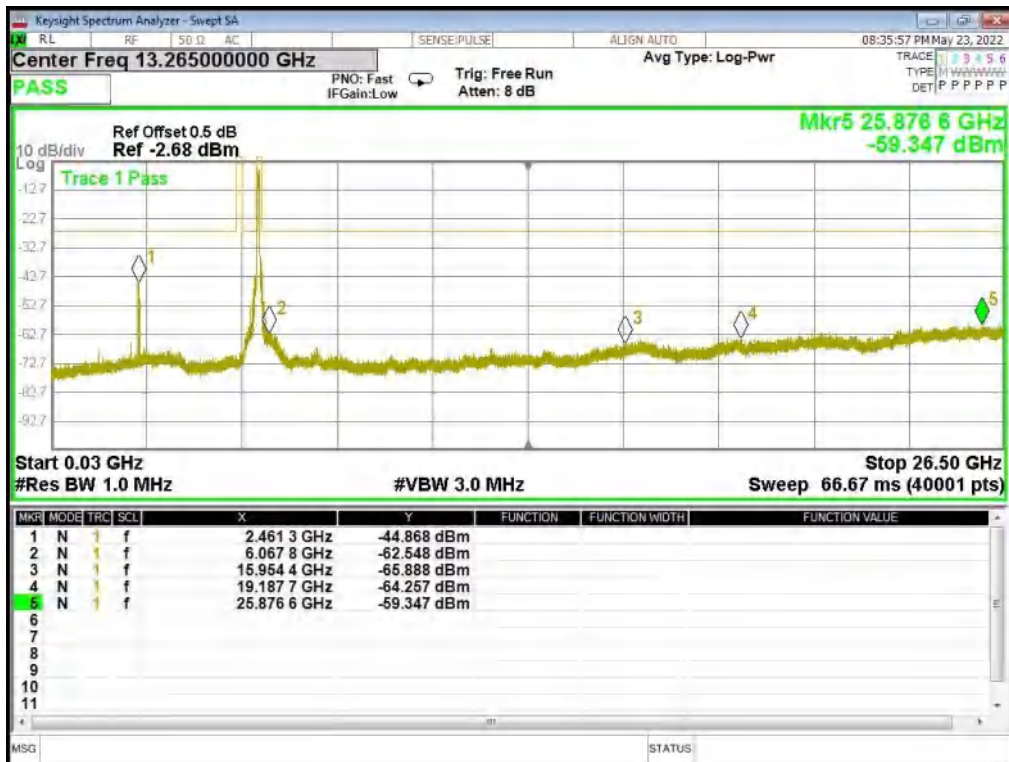

Note:1.The emission levels of other frequencies were less than 20dB margin against the limit.

8. Duty Cycle

8.1 TEST REQUIREMENT

47 CFR Part 15C 15.407 and 789033 D02 General UNII Test

Procedures New Rules v02r01(December 14, 2017), Section (B)

ANSI C63.10: 2013

8.2 TEST PROCEDURE

(1) Connect EUT's antenna output to spectrum analyzer by RF cable.

7.3 TEST SETUP

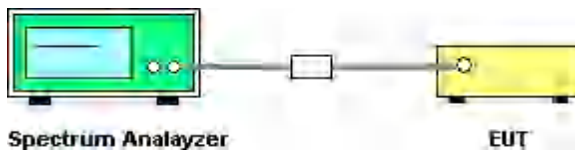

8.4 TEST RESULTS

802.11a mode			
channel	On time(ms)	Period(ms)	Duty Cycle(%)
36	100	100	100
52	100	100	100
149	100	100	100
802.11n(HT20) mode			
channel	On time(ms)	Period(ms)	Duty Cycle(%)
36	100	100	100
52	100	100	100
149	100	100	100
802.11n(HT40) mode			
channel	On time(ms)	Period(ms)	Duty Cycle(%)
38	100	100	100
54	100	100	100
151	100	100	100
802.11ac(HT20) mode			
channel	On time(ms)	Period(ms)	Duty Cycle(%)
36	100	100	100
52	100	100	100
149	100	100	100
802.11ac(HT40) mode			
channel	On time(ms)	Period(ms)	Duty Cycle(%)
38	100	100	100
54	100	100	100
151	100	100	100
802.11ac(HT80) mode			
channel	On time(ms)	Period(ms)	Duty Cycle(%)
42	100	100	100
58	100	100	100
155	100	100	100

9 RADIATED EMISSION MEASUREMENT

9.1 RADIATED EMISSION LIMITS

In any 100 kHz bandwidth outside the operating frequency band. In case the emission fall within the Restricted band specified on Part15.205(a)&209(a) limit in the table and according to ANSI C63.10-2013 below has to be followed

LIMITS OF RADIATED EMISSION MEASUREMENT (0.009MHz - 1000MHz)

Frequencies (MHz)	Field Strength (micorvolts/meter)	Measurement Distance (meters)
0.009~0.490	2400/F(KHz)	300
0.490~1.705	24000/F(KHz)	30
1.705~30.0	30	30
30~88	100	3
88~216	150	3
216~960	200	3
Above 960	500	3

For Radiated Emission

Spectrum Parameter	Setting
Attenuation	Auto
Detector	Peak/AV
Start Frequency	1000 MHz(Peak/AV)
Stop Frequency	10th carrier hamonic(Peak/AV)
RB / VB (emission in restricted band)	PK=1MHz / 1MHz, AV=1 MHz /10 Hz



9.2 TEST PROCEDURE

- a. The measuring distance of at 3 m shall be used for measurements at frequency 0.009MHz up to 1GHz, and above 1GHz.
- b. The EUT was placed on the top of a rotating table 0.8 meters (above 1GHz is 1.5 m) above the ground at a 3 meter anechoic chamber test site. The table was rotated 360 degrees to determine the position of the highest radiation.
- c. The height of the equipment shall be 0.8 m (above 1GHz is 1.5 m); the height of the test antenna shall vary between 1 m to 4 m. horizontal and vertical polarizations of the antenna are set to make the measurement.
- d. The initial step in collecting conducted emission data is a spectrum analyzer peak detector mode pre-scanning the measurement frequency range. Significant peaks are then marked and then QuasiPeak detector mode re-measured.
- e. If the Peak Mode measured value compliance with and lower than Quasi Peak Mode Limit, the EUT shall be deemed to meet QP Limits and then no additional QP Mode measurement performed.
- f. For the actual test configuration, please refer to the related Item –EUT Test Photos.

Note:

Both horizontal and vertical antenna polarities were tested and performed pretest to three orthogonal axis. The worst case emissions were reported

9.3 TESTSETUP

(A) Radiated Emission Test-Up Frequency Below 30MHz

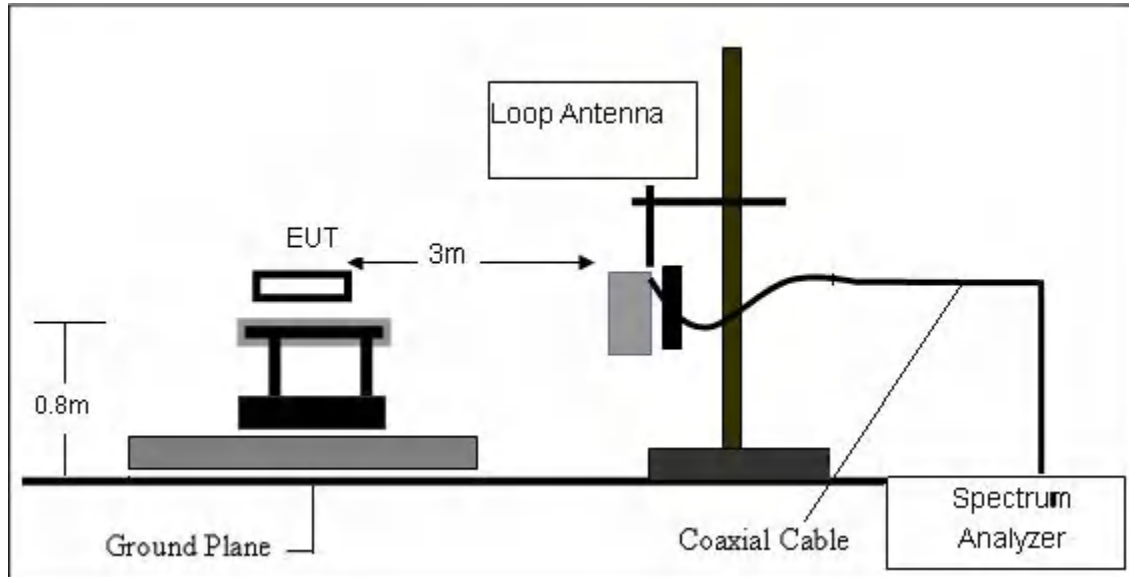

(B) Radiated Emission Test-Up Frequency 30MHz~1GHz

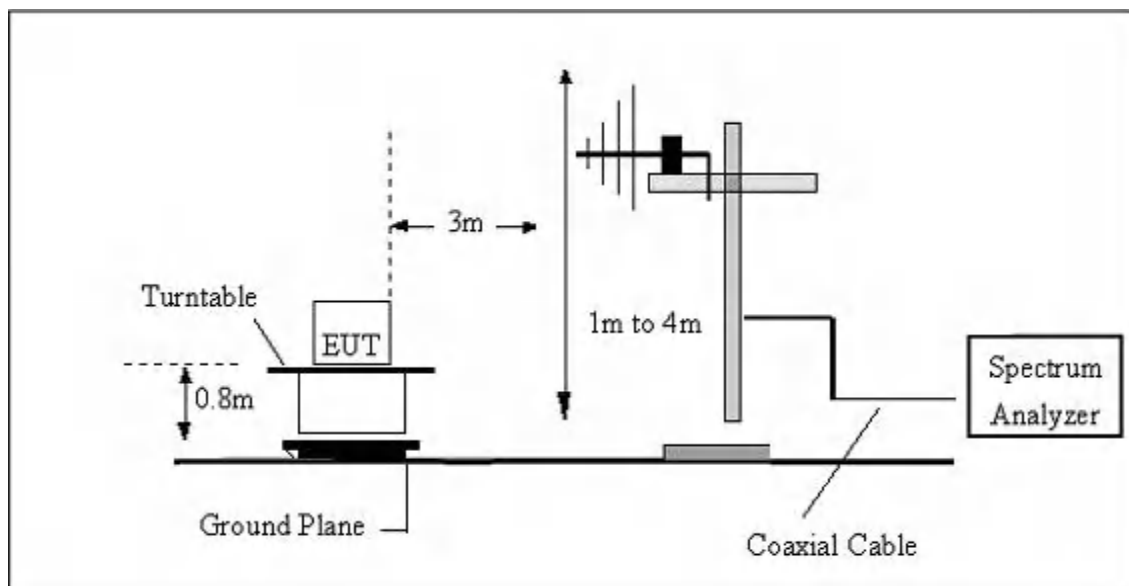

(C) Radiated Emission Test-Up Frequency Above 1GHz

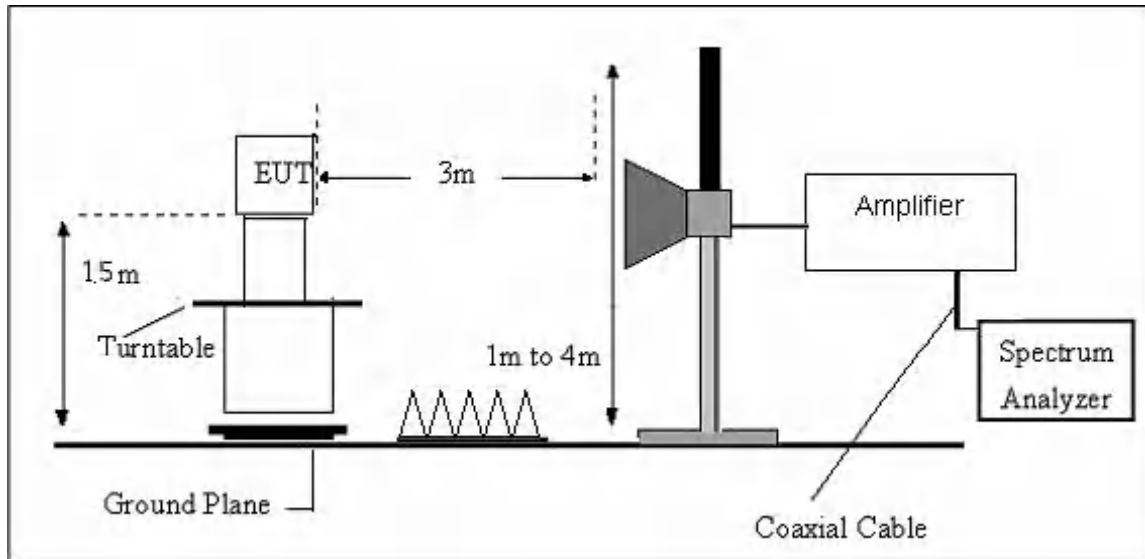



9.4. TEST RESULTS

(9KHz-30MHz)

Note:

The amplitude of spurious emissions which are attenuated by more than 20dB below the permissible value has no need to be reported.

(30MHz~40GHz) Restricted band and Spurious emission Requirements

Frequency (MHz)	Receiver Reading (dBµV)	Detector (PK/QP/Ave)	Turn table Angle Degree	RX Antenna		Corrected Factor (dB)	Corrected Amplitude (dBµV/m)	FCC Part 15.407/209/205	
				Height (m)	Polar (H/V)			Limit (dBµV/m)	Margin (dB)
802.11a U-NII-1 Low Channel 5180MHz									
223.45	39.99	QP	242	1.2	H	-11.62	28.37	46.00	-17.63
223.45	35.21	QP	57	1.3	V	-11.62	23.59	46.00	-22.41
4500.37	49.00	PK	109	1.8	H	-2.03	46.97	74.00	-27.03
4500.37	45.66	Ave	109	1.8	H	-2.03	43.63	54.00	-10.37
10360.00	41.87	PK	359	1.3	H	5.33	47.20	68.20	-26.80
10360.00	36.00	Ave	359	1.3	H	5.33	41.33	54.00	-12.67
802.11a U-NII-1 Middle channel 5200MHz									
223.45	40.79	QP	286	1.2	H	-11.62	29.17	46.00	-16.83
223.45	34.59	QP	164	1.2	V	-11.62	22.97	46.00	-23.03
4531.52	50.05	PK	246	1.8	H	-1.94	48.11	74.00	-25.89
4531.52	44.98	Ave	246	1.8	H	-1.94	43.04	54.00	-10.96
10400.00	42.05	PK	110	1.6	H	5.21	47.26	68.20	-26.74
10400.00	36.17	Ave	110	1.6	H	5.21	41.38	54.00	-12.62
802.11a U-NII-1 High channel 5240MHz									
223.45	39.33	QP	308	1.5	H	-11.62	27.71	46.00	-18.29
223.45	35.16	QP	48	1.8	V	-11.62	23.54	46.00	-22.46
4502.74	49.98	PK	298	1.7	H	-2.24	47.74	74.00	-26.26
4502.74	43.84	Ave	298	1.7	H	-2.24	41.60	54.00	-12.40
10480.00	42.03	PK	118	1.4	H	5.14	47.17	68.20	-26.83
10480.00	35.42	Ave	118	1.4	H	5.14	40.56	54.00	-13.44

Frequency (MHz)	Receiver Reading (dBμV)	Detector (PK/QP/Ave)	Turn table Angle Degree	RX Antenna		Corrected Factor (dB)	Corrected Amplitude (dBμV/m)	FCC Part 15.407/209/205	
				Height (m)	Polar (H/V)			Limit (dBμV/m)	Margin (dB)
802.11a U-NII-3 Low Channel 5745MHz									
223.45	39.11	QP	339	1.4	H	-11.62	27.49	46.00	-18.51
223.45	33.84	QP	97	2.0	V	-11.62	22.22	46.00	-23.78
4504.10	49.22	PK	114	1.3	H	-2.06	47.16	74.00	-26.84
4504.10	44.02	Ave	114	1.3	H	-2.06	41.96	54.00	-12.04
11490.00	43.05	PK	327	1.5	H	5.93	48.98	74.00	-25.02
11490.00	37.22	Ave	327	1.5	H	5.93	43.15	54.00	-10.85
802.11a U-NII-3 Middle channel 5785MHz									
223.45	37.86	QP	197	1.2	H	-11.62	26.24	46.00	-19.76
223.45	33.33	QP	359	1.1	V	-11.62	21.71	46.00	-24.29
4505.68	49.64	PK	301	1.1	H	-2.03	47.61	74.00	-26.39
4505.68	44.19	Ave	301	1.1	H	-2.03	42.16	54.00	-11.84
11570.00	42.39	PK	67	1.2	H	5.81	48.20	74.00	-25.80
11570.00	37.03	Ave	67	1.2	H	5.81	42.84	54.00	-11.16
802.11a U-NII-3 High channel 5825MHz									
223.45	36.43	QP	134	1.3	H	-11.62	24.81	46.00	-21.19
223.45	33.58	QP	238	1.1	V	-11.62	21.96	46.00	-24.04
4506.47	49.90	PK	27	1.2	H	-1.84	48.06	74.00	-25.94
4506.47	45.26	Ave	27	1.2	H	-1.84	43.42	54.00	-10.58
11650.00	40.65	PK	188	1.5	H	5.84	46.49	74.00	-27.51
11650.00	36.39	Ave	188	1.5	H	5.84	42.23	54.00	-11.77

Note:

All model are tested. Only show worst data on report.



10 CONDUCTED EMISSION TEST

10.1 POWER LINE CONDUCTED EMISSION LIMITS

Operating frequency band. In case the emission fall within the restricted band specified on Part 207(a) limit in the table below has to be followed.

FREQUENCY (MHz)	Conducted Emission limit (dBuV)	
	Quasi-peak	Average
0.15 -0.5	66 - 56 *	56 - 46 *
0.50 -5.0	56.00	46.00
5.0 -30.0	60.00	50.00

Note:

- (1) The tighter limit applies at the band edges.
- (2) The limit of " * " marked band means the limitation decreases linearly with the logarithm of the frequency in the range.

The following table is the setting of the receiver

Receiver Parameters	Setting
Attenuation	10 dB
Start Frequency	0.15 MHz
Stop Frequency	30 MHz
IF Bandwidth	9 kHz

10.2 TEST PROCEDURE

- a. The EUT was 0.8 meters from the horizontal ground plane and 0.4 meters from the vertical ground plane with EUT being connected to the power mains through a line impedance stabilization network (LISN). All other support equipments powered from additional LISN(s). The LISN provide 50 Ohm/ 50uH of coupling impedance for the measuring instrument.
- b. Interconnecting cables that hang closer than 40 cm to the ground plane shall be folded back and forth in the center forming a bundle 30 to 40 cm long.
- c. I/O cables that are not connected to a peripheral shall be bundled in the center. The end of the cable may be terminated, if required, using the correct terminating impedance. The overall length shall not exceed 1 m.
- d. LISN at least 80 cm from nearest part of EUT chassis.
- e. For the actual test configuration, please refer to the related Item –EUT Test Photos.

10.3 TEST SETUP

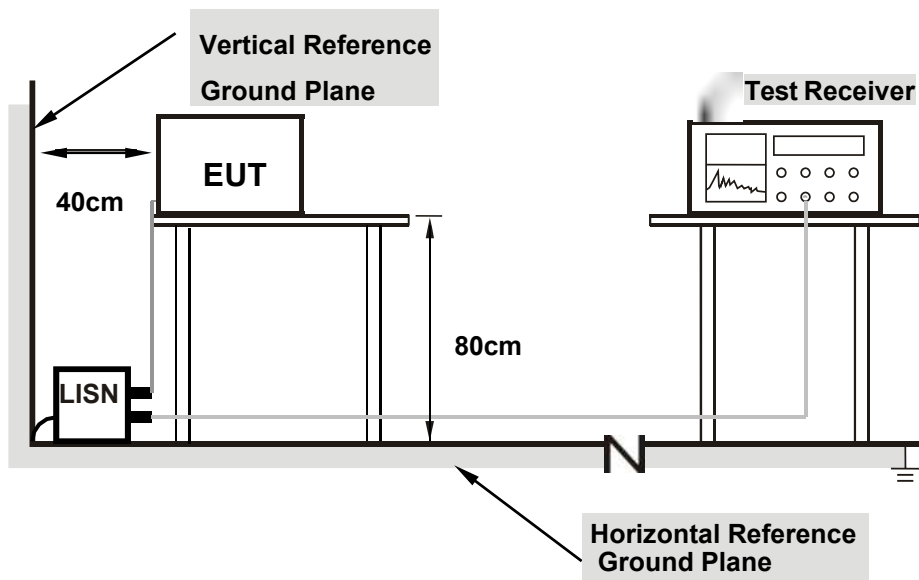

- Note: 1.Support units were connected to second LISN.**
2.Both of LISNs (AMN) are 80 cm from EUT and at least 80 from other units and other metal planes

10.4 TEST RESULT

Temperature:	22.1 °C	Relative Humidity:	56%
Test Voltage:	DC 5V	Phase:	L/N
Test Mode:	ON		

No.	Frequency (MHz)	Reading (dBuV)	Correct Factor(dB/m)	Result (dBuV/m)	Limit (dBuV/m)	Margin (dB)	Remark
1	0.4875	31.49	9.87	41.36	56.21	14.85	QP
2	0.4875	25.90	9.87	35.77	46.21	10.44	AVG
3	0.7080	31.66	9.89	41.55	56.00	14.45	QP
4	0.7080	22.04	9.89	31.93	46.00	14.07	AVG
5	3.7725	24.43	17.90	42.33	56.00	13.67	QP
6	3.7725	12.17	17.90	30.07	46.00	15.93	AVG
7	8.1555	27.25	20.00	47.25	60.00	12.75	QP
8	8.1555	12.33	20.00	32.33	50.00	17.67	AVG
9	11.5034	26.08	20.04	46.12	60.00	13.88	QP
10	11.5034	13.93	20.04	33.97	50.00	16.03	AVG
11	16.7685	23.90	20.13	44.03	60.00	15.97	QP
12	16.7685	12.82	20.13	32.95	50.00	17.05	AVG

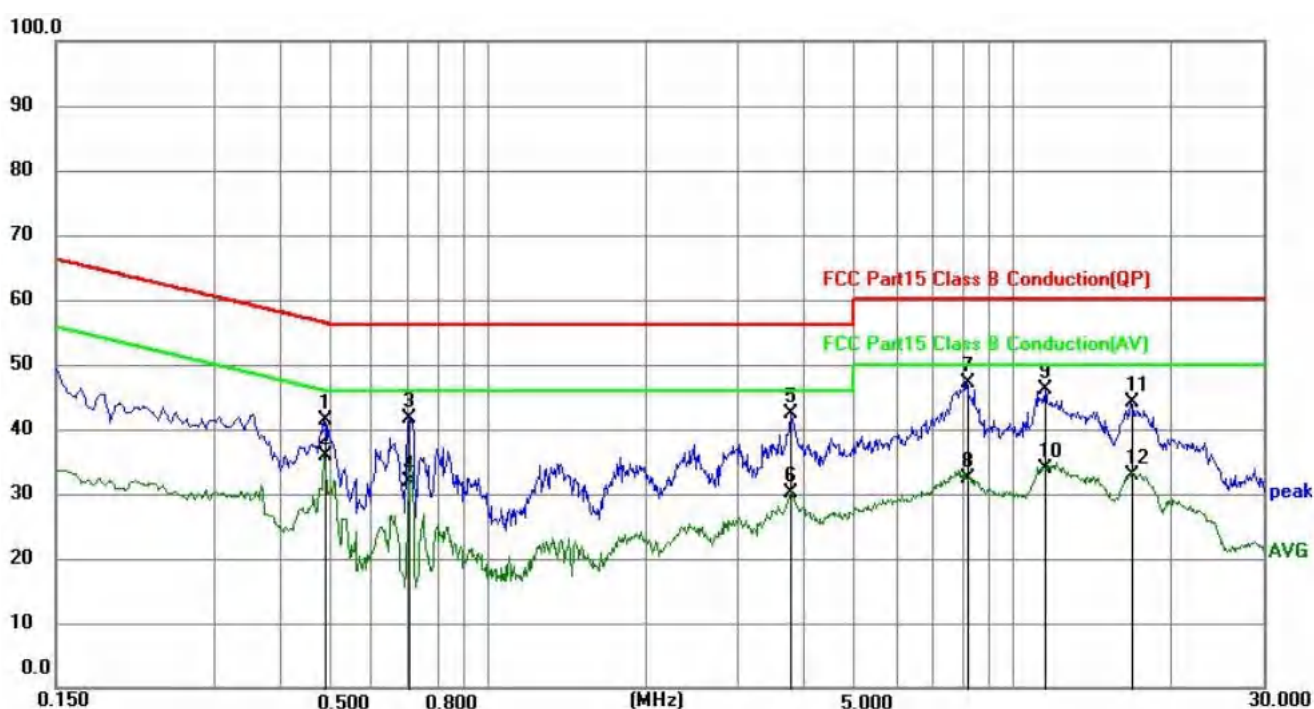

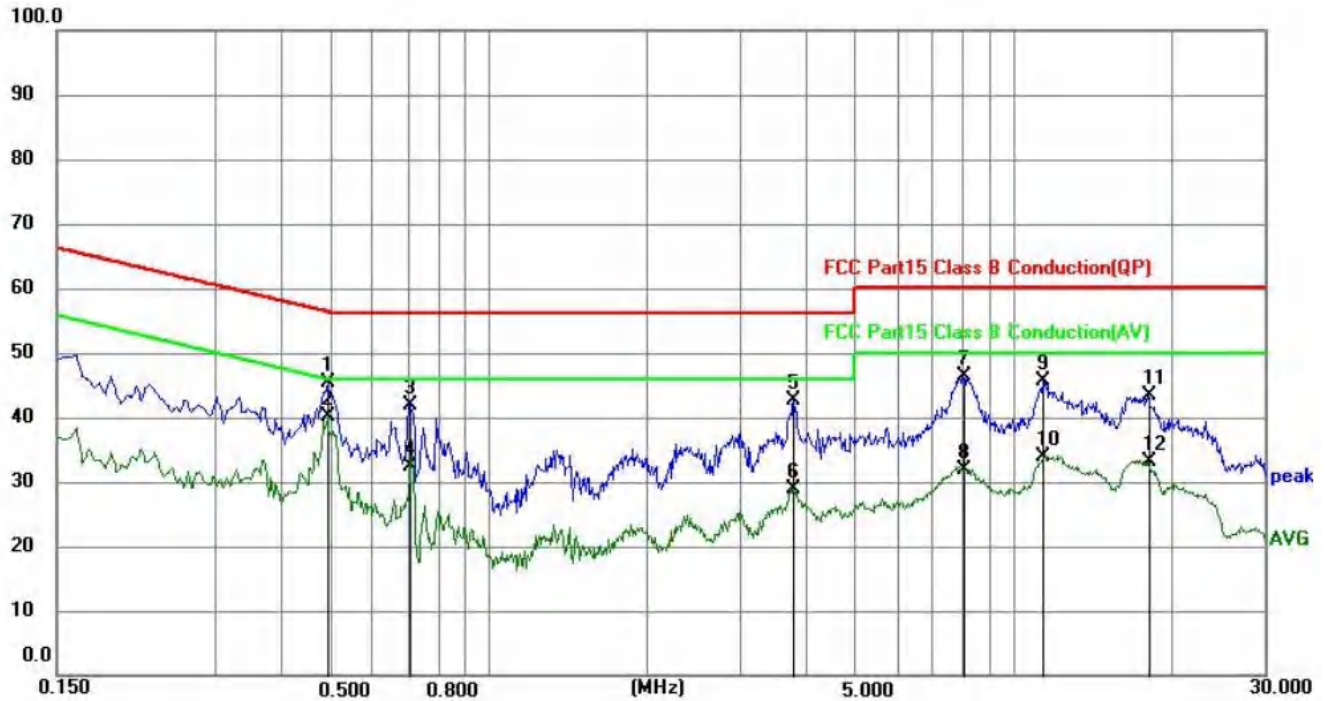

No.	Frequency (MHz)	Reading (dBuV)	Correct Factor(dB/m)	Result (dBuV/m)	Limit (dBuV/m)	Margin (dB)	Remark
1	0.4920	35.46	9.87	45.33	56.13	10.80	QP
2	0.4920	30.33	9.87	40.20	46.13	5.93	AVG
3	0.7080	32.01	9.89	41.90	56.00	14.10	QP
4	0.7080	22.38	9.89	32.27	46.00	13.73	AVG
5	3.8130	24.69	18.00	42.69	56.00	13.31	QP
6	3.8130	10.88	18.00	28.88	46.00	17.12	AVG
7	8.0070	26.35	20.14	46.49	60.00	13.51	QP
8	8.0070	11.80	20.14	31.94	50.00	18.06	AVG
9	11.3549	25.56	20.19	45.75	60.00	14.25	QP
10	11.3549	13.72	20.19	33.91	50.00	16.09	AVG
11	17.9790	23.14	20.24	43.38	60.00	16.62	QP
12	17.9790	12.79	20.24	33.03	50.00	16.97	AVG



11. ANTENNA REQUIREMENT

11.1 STANDARD REQUIREMENT

For intentional device, according to FCC 47 CFR Section 15.203, an intentional radiator shall be designed to ensure that no antenna other than that furnished by the responsible party shall be used with the device. And according to FCC 47 CFR Section 15.247 (b), if transmitting antennas of directional gain greater than 6dBi are used, the power shall be reduced by the amount in dB that the directional gain of the antenna exceeds 6dBi.

11.2 RESULT

The antennas used for this product are external antenna and other than that furnished by the responsible party shall be used with the device, the maximum peak gain of the transmit antenna is 1.0 dBi.

*****END OF THE REPORT*****