

# USER INSTRUCTIONS AND OPERATIONS GUIDE



**Mammotome revolve**  
dual vacuum-assisted biopsy system



[www.mammotome.com/ifu](http://www.mammotome.com/ifu)

eIFU number: **001413**

## Table of Contents

|                                                                |      |
|----------------------------------------------------------------|------|
| CHAPTER 1 INTRODUCTION .....                                   | 1-1  |
| Indications .....                                              | 1-1  |
| Contraindications .....                                        | 1-1  |
| Warnings .....                                                 | 1-1  |
| General.....                                                   | 1-2  |
| System.....                                                    | 1-2  |
| Control Module.....                                            | 1-3  |
| Holster.....                                                   | 1-3  |
| Probe.....                                                     | 1-3  |
| Training .....                                                 | 1-4  |
| System Components .....                                        | 1-4  |
| CHAPTER 2 SYSTEM DESCRIPTION .....                             | 2-1  |
| Overview—System Description .....                              | 2-1  |
| Control Module.....                                            | 2-3  |
| Cart .....                                                     | 2-3  |
| EX Holders (Cart Detachable Component).....                    | 2-4  |
| ST Probe and Vacuum Tube Set.....                              | 2-4  |
| U/S Probe and Vacuum Tube Set.....                             | 2-7  |
| EX Probe, Vacuum Tube Set, and Sleeve .....                    | 2-9  |
| Input Devices .....                                            | 2-11 |
| Detachable Components .....                                    | 2-19 |
| System Software .....                                          | 2-20 |
| CHAPTER 3 INITIAL INSTALLATION AND GETTING STARTED.....        | 3-1  |
| Preventative Maintenance.....                                  | 3-1  |
| Unpacking/Assembling the Mammutome revolve Control Module..... | 3-1  |
| Unpacking the Cart.....                                        | 3-2  |
| Unpacking the EX Holder (Cart Detachable Component) .....      | 3-2  |
| Placing the Control Module on the Cart .....                   | 3-2  |
| Unpacking the Holster.....                                     | 3-3  |
| Unpacking the Remote Footswitch.....                           | 3-3  |
| Unpacking the Remote Keypad.....                               | 3-3  |
| Setup .....                                                    | 3-3  |

|                                                                                                           |            |
|-----------------------------------------------------------------------------------------------------------|------------|
| 1. Powering on the Control Module .....                                                                   | 3-3        |
| 2. Connecting the Holster to the Control Module.....                                                      | 3-4        |
| 3. (OPTIONAL) Attaching the EX Holder (Cart Detachable Component) to the Cart.....                        | 3-6        |
| 4. (OPTIONAL) Connecting the Remote Footswitch to the Control Module .....                                | 3-6        |
| 5. (OPTIONAL) Connecting the Remote Keypad to the Control Module.....                                     | 3-6        |
| 6. Connecting the Vacuum Canister to the Control Module .....                                             | 3-6        |
| 7. (OPTIONAL – EX ONLY) Connecting the Sleeve to the Mammotome revolve EX Holster .....                   | 3-7        |
| 8. Loading the Mammotome revolve Probe onto the Mammotome revolve Holster.....                            | 3-8        |
| 9. Connecting the Probe Vacuum Tube Set to the Mammotome revolve Dual Vacuum-Assisted Biopsy System ..... | 3-13       |
| 10. Holster/Probe Assembly Initialization .....                                                           | 3-15       |
| 11. Select Side of Holster and Ready for Procedure (ST Only) .....                                        | 3-16       |
| <b>Chapter 4 STEREOTACTIC (ST) INSTRUCTIONS FOR USE .....</b>                                             | <b>4-1</b> |
| Overview .....                                                                                            | 4-1        |
| Mammotome revolve ST Probe and ST Holster.....                                                            | 4-1        |
| Preparation for Use.....                                                                                  | 4-3        |
| Instructions for Use.....                                                                                 | 4-3        |
| Steps for Tissue Sampling .....                                                                           | 4-3        |
| Other Instructions.....                                                                                   | 4-7        |
| Disassembling the Mammotome revolve Dual Vacuum-Assisted Biopsy System.....                               | 4-9        |
| Shutting down the Mammotome revolve Dual Vacuum-Assisted Biopsy System .....                              | 4-11       |
| <b>Chapter 5 ULTRASOUND (U/S) INSTRUCTIONS FOR USE.....</b>                                               | <b>5-1</b> |
| Overview .....                                                                                            | 5-1        |
| Mammotome revolve U/S Probe and U/S Holster .....                                                         | 5-1        |
| Preparation for Use.....                                                                                  | 5-2        |
| Instructions for Use.....                                                                                 | 5-3        |
| Steps for Tissue Sampling .....                                                                           | 5-3        |
| Other Instructions.....                                                                                   | 5-5        |
| Disassembling the Mammotome revolve Biopsy System.....                                                    | 5-7        |
| Disconnecting Input Devices.....                                                                          | 5-8        |
| Shutting Down the Mammotome revolve Dual Vacuum-Assisted Biopsy System.....                               | 5-8        |
| <b>Chapter 6 EX INSTRUCTIONS FOR USE .....</b>                                                            | <b>6-1</b> |
| Overview .....                                                                                            | 6-1        |
| Mammotome revolve EX Probe and EX Holster .....                                                           | 6-1        |
| Preparation for Use.....                                                                                  | 6-2        |

|                                                                                 |      |
|---------------------------------------------------------------------------------|------|
| Instructions for Use.....                                                       | 6-2  |
| Steps for Tissue Sampling .....                                                 | 6-2  |
| Other Instructions.....                                                         | 6-5  |
| Disassembling the Mammotome revolve Biopsy System.....                          | 6-7  |
| Shutting Down the Mammotome revolve Dual Vacuum-Assisted Biopsy System.....     | 6-10 |
| CHAPTER 7 CLEANING AND DISINFECTION .....                                       | 7-1  |
| Introduction .....                                                              | 7-1  |
| Cleaning Instructions for the Control Module, Cart, and Remote Footswitch ..... | 7-1  |
| Cleaning and Disinfection Instructions for the Holsters and Remote Keypad.....  | 7-2  |
| Cleaning the ST or U/S Holster: Option 1 .....                                  | 7-2  |
| Cleaning the ST or U/S Holster: Option 2 .....                                  | 7-2  |
| Disinfecting the ST or U/S Holster: Option 1 .....                              | 7-3  |
| Disinfecting the ST or U/S Holster: Option 2 .....                              | 7-3  |
| Cleaning the EX Holster.....                                                    | 7-4  |
| Disinfecting the EX Holster .....                                               | 7-4  |
| Cleaning the Holster Holder.....                                                | 7-4  |
| Cleaning the Remote Keypad: Option 1.....                                       | 7-5  |
| Cleaning the Remote Keypad: Option 2.....                                       | 7-5  |
| Disinfecting the Remote Keypad: Option 1 .....                                  | 7-5  |
| Disinfecting the Remote Keypad: Option 2 .....                                  | 7-6  |
| Chapter 8 SOFTWARE DESCRIPTION.....                                             | 8-1  |
| Touchscreens and Screen Button Functions.....                                   | 8-1  |
| Device Confirmation and Initialization Screens .....                            | 8-1  |
| ST and U/S Procedure Screens.....                                               | 8-3  |
| EX Procedure Screens .....                                                      | 8-9  |
| Standby Screens.....                                                            | 8-13 |
| Utilities Screens .....                                                         | 8-14 |
| CHAPTER 9 SERVICE AND TROUBLESHOOTING .....                                     | 9-1  |
| Service.....                                                                    | 9-1  |
| Contact Information.....                                                        | 9-8  |
| Chapter 10 SYSTEM SPECIFICATIONS .....                                          | 10-1 |
| Classification .....                                                            | 10-1 |
| Storage/Operating Conditions .....                                              | 10-2 |
| Electrical Specifications.....                                                  | 10-2 |
| System Specifications.....                                                      | 10-5 |

|                                                                      |      |
|----------------------------------------------------------------------|------|
| RFID Frequency Information .....                                     | 10-6 |
| WEEE (The Waste Electrical and Electronic Equipment Directive) ..... | 10-7 |
| All Other Symbol and Labeling Information.....                       | 10-7 |
| How Supplied .....                                                   | 10-7 |
| Responsibility of the Manufacturer .....                             | 10-7 |
| Calling for Service.....                                             | 10-8 |
| Requesting a Paper Copy of the Information for Use (IFU) .....       | 10-8 |
| Additional Product Information .....                                 | 10-8 |
| Chapter 11 WARRANTY.....                                             | 11-1 |
| Chapter 12 STEREOTACTIC (ST) HOLSTER STATES.....                     | 12-1 |

## Chapter 1 INTRODUCTION

---

*Please read all information carefully.*

**WARNING: FAILURE TO FOLLOW THE INSTRUCTIONS MAY LEAD TO SERIOUS SURGICAL CONSEQUENCES.**

**All information in this guide applies to Stereotactic Guided Procedures (ST) and Ultrasound Guided Procedures (U/S, EX) unless otherwise stated.**

**IMPORTANT:** This document is designed to provide instructions for use of the Mammotome revolve Dual Vacuum-Assisted Biopsy System. It is not a reference to surgical technique. Access to the internet and a .pdf viewer is required to view the full electronic Instructions for Use.

**NOTE:** The information in this guide is subject to change without notice.

### Indications

---

The Mammotome revolve Dual Vacuum Assisted Biopsy (VAB) System is indicated to provide tissue samples for diagnostic sampling of breast abnormalities.

- The Mammotome revolve Dual Vacuum Assisted Biopsy (VAB) System is intended to provide breast tissue for histologic examination with partial or complete removal of the imaged abnormality.
- The Mammotome revolve Dual Vacuum Assisted Biopsy (VAB) System is intended to provide breast tissue for histologic examination with partial removal of a palpable abnormality.

The extent of a histologic abnormality cannot always be readily determined from palpation or imaged appearance. Therefore, the extent of removal of the palpated or imaged evidence of an abnormality does not predict the extent of removal of a histologic abnormality, e.g., malignancy. When the sampled abnormality is not histologically benign, it is essential that the tissue margins be examined for completeness of removal using standard surgical procedures.

In instances when a patient presents with a palpable abnormality that has been classified as benign through clinical and/or radiological criteria (e.g., fibroadenoma, fibrocystic lesion), the Mammotome revolve Dual Vacuum Assisted Biopsy (VAB) System may also be used to partially remove such palpable lesions. Whenever breast tissue is removed, histological evaluation of the tissue is the standard of care. When the sampled abnormality is not histologically benign, it is essential that the tissue margins be examined for completeness of removal using standard surgical procedures.

### Contraindications

---

- This device is not intended for use except as indicated.
- The instrument is contraindicated for those patients where increased risk or complications may be associated with the percutaneous removal of tissue samples based upon the physician's judgment. Patients receiving anticoagulant therapy or who may have bleeding disorders may be at increased risk.

### Warnings

---

Please read all the contents of the User Instructions and Operations Guide for your Mammotome revolve Dual Vacuum-Assisted Biopsy System prior to installation and operation. Follow all warnings and instructions as stated in this guide and retain this guide for future reference.

## General

- the Mammotome revolve Dual Vacuum-Assisted Biopsy System is used in the presence of flammable anesthetics. Avoid at all costs.
- As with any medical procedure, there is potential risk for infection.
- Minimally invasive instruments may vary in dimensions (e.g., diameter) from manufacturer to manufacturer. When minimally invasive instruments and accessories from different manufacturers are employed together in a procedure, verify compatibility prior to initiation of the procedure.
- Minimally invasive procedures should be performed only by persons having adequate training and familiarity with minimally invasive techniques. Consult medical literature relative to techniques, complications, and hazards prior to performance of any minimally invasive procedure.

## System

- To avoid the risk of electrical shock, this equipment must only be connected to a supply mains with protective earth.
- Changes or modifications not expressly approved by the party responsible for compliance could void the user's authority to operate the equipment.
- This medical device emits electromagnetic energy that may interfere with other nearby medical devices, which may cause those devices to malfunction or seriously harm the patient.
- Do not use the Mammotome revolve Dual Vacuum-Assisted Biopsy System in an oxygen-rich environment due to a small risk of fire. Avoid at all costs.
- Do not use this instrument in conjunction with Magnetic Resonance Imaging (MRI).
- This instrument should be used only by physicians trained in percutaneous needle techniques for tissue collection.
- Do not attempt to sterilize the holsters, control module, cart, remote keypad, or remote footswitch through autoclave, ethylene oxide, radiation, or plasma sterilization procedures. Do not spray with fluids or submerge in fluids; this may damage the instrument. Improper cleaning may void the warranties.
- Do not process the device through an automated washer-disinfect or ultrasound bath.
- Minimally invasive procedures should be performed only by persons having adequate training and familiarity with minimally invasive techniques. Consult medical literature relative to techniques, complications, and hazards prior to performance of any minimally invasive procedure.
- Do not immerse electrosurgical instruments in liquid unless the instruments are designed and labeled to be immersed.
- The Mammotome revolve Dual Vacuum Assisted Biopsy System is not suitable for use in environments that contain a mixture of flammable anesthetic and air or oxygen and nitrous oxide.
- Do not remove the vacuum tubing from the vacuum canister when the vacuum is being used by the system.
- Products manufactured or distributed by companies not authorized by Devicor Medical Products, Inc. may not be compatible with the Mammotome revolve Dual Vacuum-Assisted Biopsy System. Use of such products may lead to unanticipated results and possible injury to the user or patient.

- Attempts to disassemble or service any Mammotome product other than in the manner described in the product's accompanying labeling, or by anyone other than a qualified technician, may cause injury because of electrical shock.
- All appropriate surgical room safety precautions should be observed and implemented before and during the tissue sampling procedure.
- Inspect the power cords on the holster, remote footswitch, and remote keypad for fraying or damage prior to each use. Do not use the component if it shows signs of damage or wear.
- Do not touch exposed parts of connectors on the control module, holster, or touchscreen while simultaneously contacting the patient, as safety hazards may exist.
- Ensure that all cords are clear of the cart wheels prior to transporting the system.
- Do not attempt to open or access internal components of the Mammotome revolve Dual Vacuum-Assisted Biopsy System, as safety hazards may exist.
- No modification of this equipment is allowed.
- Do not modify this equipment without the manufacturer's authorization. If this equipment is modified, appropriate inspection and testing must be conducted to ensure the continued safe use of equipment.
- The pressure differential created in the canister during the procedure can cause blood discharge.
- This medical device emits electromagnetic energy that may interfere with other nearby medical devices, which may cause those devices to malfunction or serious injury to patient.

#### **Control Module**

- To ensure adequate ventilation, position the control module at least 6" (15.24 cm) from all walls. Do not block the exhaust fan at the rear of the control module. Do not position the device where it is difficult to operate the mains disconnect device. The power switch is used for mains disconnect.
- Do not use if the Control Module is damaged. Electric shock is possible.
- To avoid the risk of electrical shock, this equipment must only be connected to a supply mains with protective earth."

#### **Holster**

- When system power is on, keep the holster cavity clear of all foreign objects.
- During use, ensure the electric cable is not pinched or bound. The cable should be free of kinks or stress for proper operation.

#### **Probe**

- Do not reuse, reprocess, or resterilize the probe. The device is packaged and sterilized for single use only. Reuse, reprocessing, or resterilization may compromise the structural integrity of the device and/or lead to device failure, which may result in patient injury, illness, or death. In addition, reprocessing or resterilization of single use devices may create a risk of contamination and/or cause patient infection or cross-infection, including, but not limited to, the transmission of infectious disease(s) from one patient to another. Contamination of the device may lead to injury, illness, or death of the patient.
- Ensure that the connection tubes are not placed over the docked handpiece.



- Avoid scraping of the needle tip against the protective sleeve should remain on the probe needle until you are ready to perform the tissue sampling procedure.
- and injury while removing the protective sleeve.
- Disconnect the saline spike from the saline bag. Discard the saline bag using standard medical techniques after each patient use.
- Keep hands clear of the sample aperture and probe needle tip at all times.
- Do not probe tubing pathways should be free from debris during use.
- Take special care to avoid bending or twisting the probe.
- If the probe is bent, do not use. Dispose of the probe in the appropriate container.
- Instruments or devices that come into contact with bodily fluids may require special disposal handling to prevent biological contamination.
- When placing or removing the holster/probe assembly to or from the docking station on the cart, ensure no contact is made between sterile and non-sterile surfaces (e.g., needle tip to cart surfaces or control module).

## Training

---

### New Installations

In-service training is provided at the customer's site.

### Repeat Training and Clinical Application Consultation

Repeat of in-service training and clinical application consultation is available at the customer's request. (See [Chapter 9, Service and Troubleshooting, Contact Information.](#))

## System Components

---

Only the devices identified below are designed for compatible functionality with the system. The Mammotome revolve Biopsy System comprises the following components:

### Mammotome revolve EX System (for Ultrasound Guided Procedures)

- Mammotome revolve Control Module
- Mammotome revolve Cart
- Mammotome revolve EX Holster
- Mammotome revolve EX Probe (provided with or without Holster sleeve)
- Mammotome revolve Remote Footswitch
- Mammotome revolve Remote Keypad
- Mammotome revolve System Software
  - The Mammotome revolve EX Holster and EX Probes are only compatible with Mammotome revolve System Software.
- Bemis 800cc Vacuum Canister (Manufactured for use with the Mammotome revolve dual Vacuum-Assisted Biopsy System)
- Mammotome revolve EX Holders (Cart Detachable Component)

### Mammotome revolve ST System (for Stereotactic Guided Procedures)

- Mammotome revolve Control Module

- Mammotome revolve Cart
- Mammotome revolve ST Holster
- Mammotome revolve ST Probe (with attached Specimen Management System and Vacuum Tube Set)
- Mammotome revolve Remote Footswitch
- Mammotome revolve Remote Keypad
- Mammotome revolve System Software
  - The Mammotome revolve ST Holster and ST Probes are only compatible with Mammotome revolve System Software.
- Bemis 800cc Vacuum Canister (Manufactured for use with the Mammotome revolve dual Vacuum-Assisted Biopsy System)
- Mammotome revolve Specimen Management System(s)
- Mammotome revolve Probe Guide(s)

**Mammotome revolve U/S System (for Ultrasound Guided Procedures)**

- Mammotome revolve Control Module
- Mammotome revolve Cart
- Mammotome revolve U/S Holster
- Mammotome revolve U/S Probe (with attached Specimen Management System and Vacuum Tube Set)
- Mammotome revolve Remote Footswitch
- Mammotome revolve Remote Keypad
- Mammotome revolve System Software
  - The Mammotome revolve U/S Holster and U/S Probes are only compatible with Mammotome revolve System Software.
- Bemis 800cc Vacuum Canister (Manufactured for use with the Mammotome revolve Biopsy System)
- Mammotome revolve Specimen Management System(s)

## Chapter 2 SYSTEM DESCRIPTION

---

*All information in this guide applies to ST, U/S, and EX modalities, unless otherwise stated.*

### Overview—System Description

---

The Mammotome revolve Dual Vacuum-Assisted Biopsy System allows the user to sample breast tissue that has been identified as suspicious under imaging guidance. Multiple tissue samples can be taken without removing the needle. The user may identify the tissue as it is collected to correspond with the imaging display.

The Mammotome revolve Dual Vacuum-Assisted Biopsy System comprises three primary subsystems:

1. **Control Module:** a reusable control module, containing the vacuum pump, power supply, valve actuators, user touchscreen interface, and control electronics.
2. **Holster:** a reusable holster, containing the drive motors, gear trains, and user activation buttons.
3. **Probe:** a disposable single-patient use probe, containing the biopsy needle, specimen management system, and vacuum tube set.

In addition, several optional reusable detachable components are available including a transport cart, remote footswitch, and remote keypad controls. Disposable detachable components required include a vacuum canister (ST, U/S, and EX), probe guides (ST only) and a probe and holster holder (EX only). A disposable Holster Sleeve (EX only) for single-patient use, provided with a packaged EX Probe, is intended to provide a barrier between the user's gloved hand and reusable Holster.

**NOTE:** The *usable* volume of the canister is 800cc.

Fluids can be delivered through the Mammotome revolve probe for managing selected patient/procedure requirements.

Biopsy site identifiers may be used in conjunction with the ST and U/S probes to radiographically mark the location of the biopsy procedure. In the event of removal of evidence of the abnormality, it is strongly recommended that a biopsy site identifier or other marking device be placed to mark the biopsy site (in case follow-up is required).

**NOTE:** Biopsy site identifiers are not intended to be placed through the EX probe. Alternative methods should be used if placement of a biopsy site identifier is required.

**NOTE:** Refer to the Biopsy Site Identifier Instructions for Use for compatibility, confirmed fit, function, and length with the Mammotome revolve Dual Vacuum-Assisted Biopsy System.

The Mammotome revolve Dual Vacuum-Assisted Biopsy System comprises the following components and input devices:

**Figure 1. Mammotome revolve Dual Vacuum-Assisted Biopsy System Components**



## Control Module

The Control Module is an electronic device that runs the software necessary to operate the Mammotome revolve Dual Vacuum-Assisted Biopsy System. The device also houses the vacuum pump, power supply, valve actuators, user touchscreen interface, and control electronics.

**Figure 2. Control Module Illustration and Nomenclature**

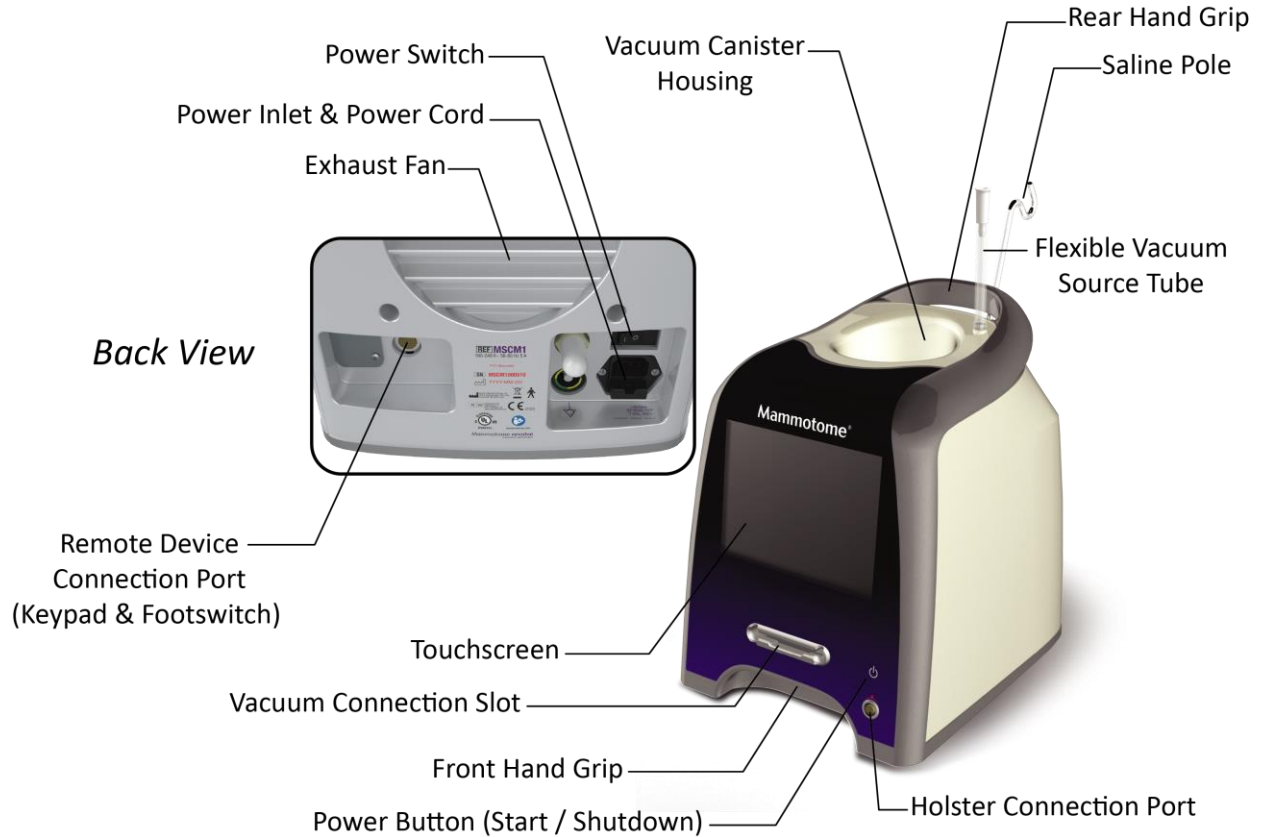

## Cart

The cart is designed exclusively for use with Mammotome revolve Dual Vacuum-Assisted Biopsy System and is used for moving the control module in the clinical environment.

**NOTE:** The working load of the Mammotome revolve cart is equivalent to the mass of the Mammotome revolve components (control module, footswitch, remote control, ST holster and holder, EX holster and holder), which is 34 lbs. The total mass of the Mammotome revolve cart loaded with the Mammotome revolve system is 75 lbs.

**Figure 3. Cart Illustration and Nomenclature**

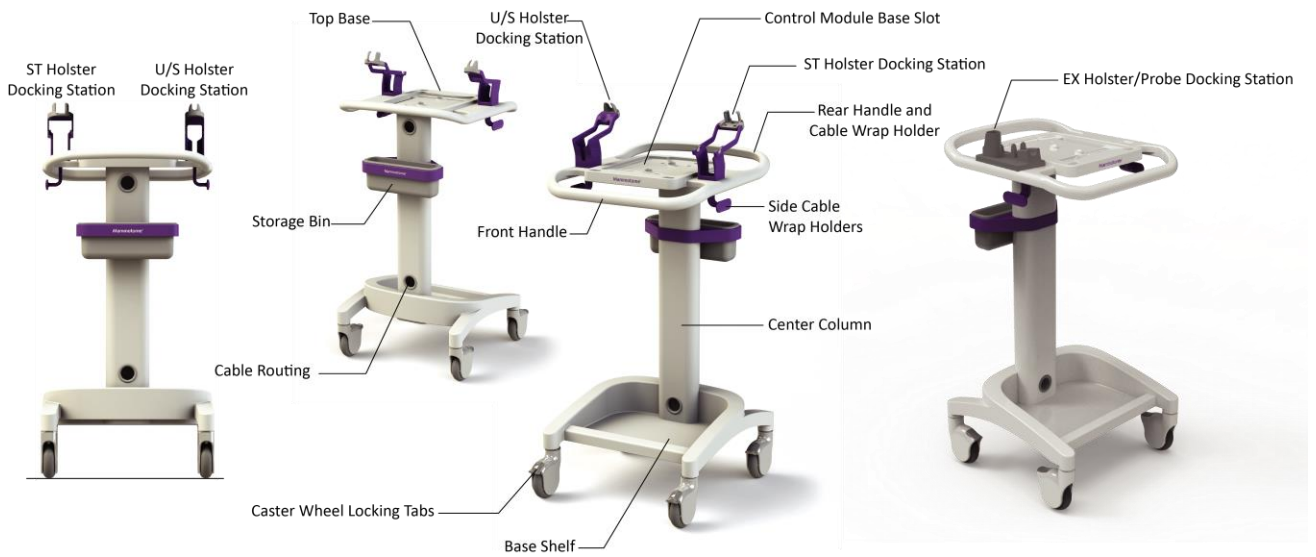

**EX Holders (Cart Detachable Component)**

The EX holders are designed exclusively for use with the Mammotome revolve Cart to contain the Mammotome revolve EX Holster and/or EX Probe in the clinical environment.

**Figure 4.: EX Holders Illustration**

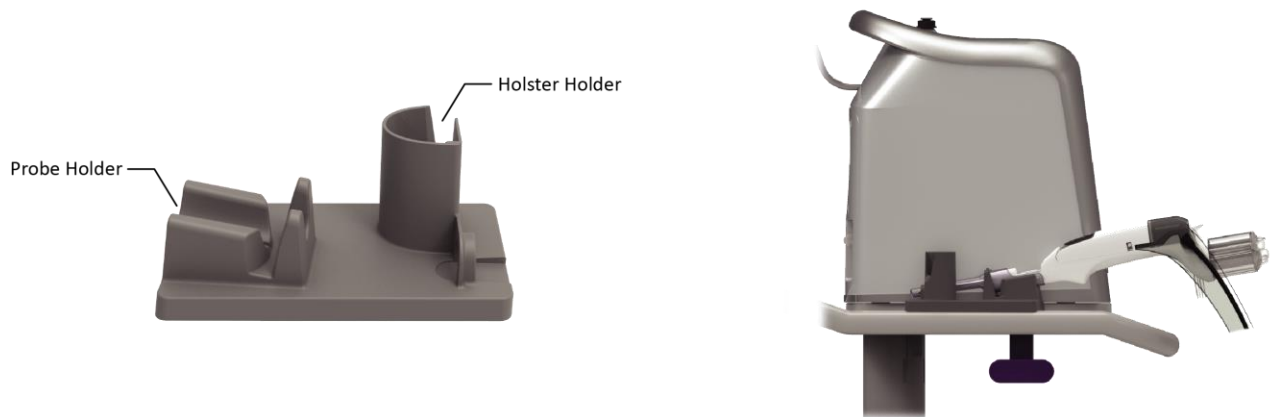

**ST Probe and Vacuum Tube Set**

The ST Probe (along with its integrated components: Specimen Management System and Vacuum Tube Set) is a sterile, single-patient use device that may be used with imaging guidance to excise a tissue sample for diagnosis. The probe is designed to be loaded onto the ST holster. The body of the probe contains locking tabs to secure the probe to the ST holster. The probe consists of an outer trocar shaft and an inner cutter in a distal sample aperture. The sample aperture can be rotated to the desired orientation using either the probe's aperture rotation thumbwheel or the ST Holster aperture rotation knobs.

The probe comes packaged with an attached vacuum tube set. The vacuum tube set connects the probe to a vacuum source through the surgical side of a vacuum canister and allows fluid collected from the probe to be drained into the canister. The tube set has three points of attachment: 1) to the

control module vacuum connection slot, 2) to the vacuum canister port, and 3) to a saline bag.

For further convenience, the probe includes a Specimen Management System consisting of 12 proximal specimen collection chambers. Each collection chamber is designed to capture and hold excised tissue. The specimen collection chambers are designed to be removed from the fluid management manifold in two separate trays (of six chambers each). If desired, the tissue can remain in the chambers to be directly imaged in the post-biopsy specimen radiograph.

A biopsy site identifier may be used in conjunction with the Mammotome revolve probes to radiographically mark the location of the biopsy procedure. In the event of removal of evidence of abnormality, it is strongly recommended that a marking device be placed to mark the biopsy site in case follow-up is required.

**Figure 5. ST Probe and Vacuum Tube Set Illustration and Nomenclature**

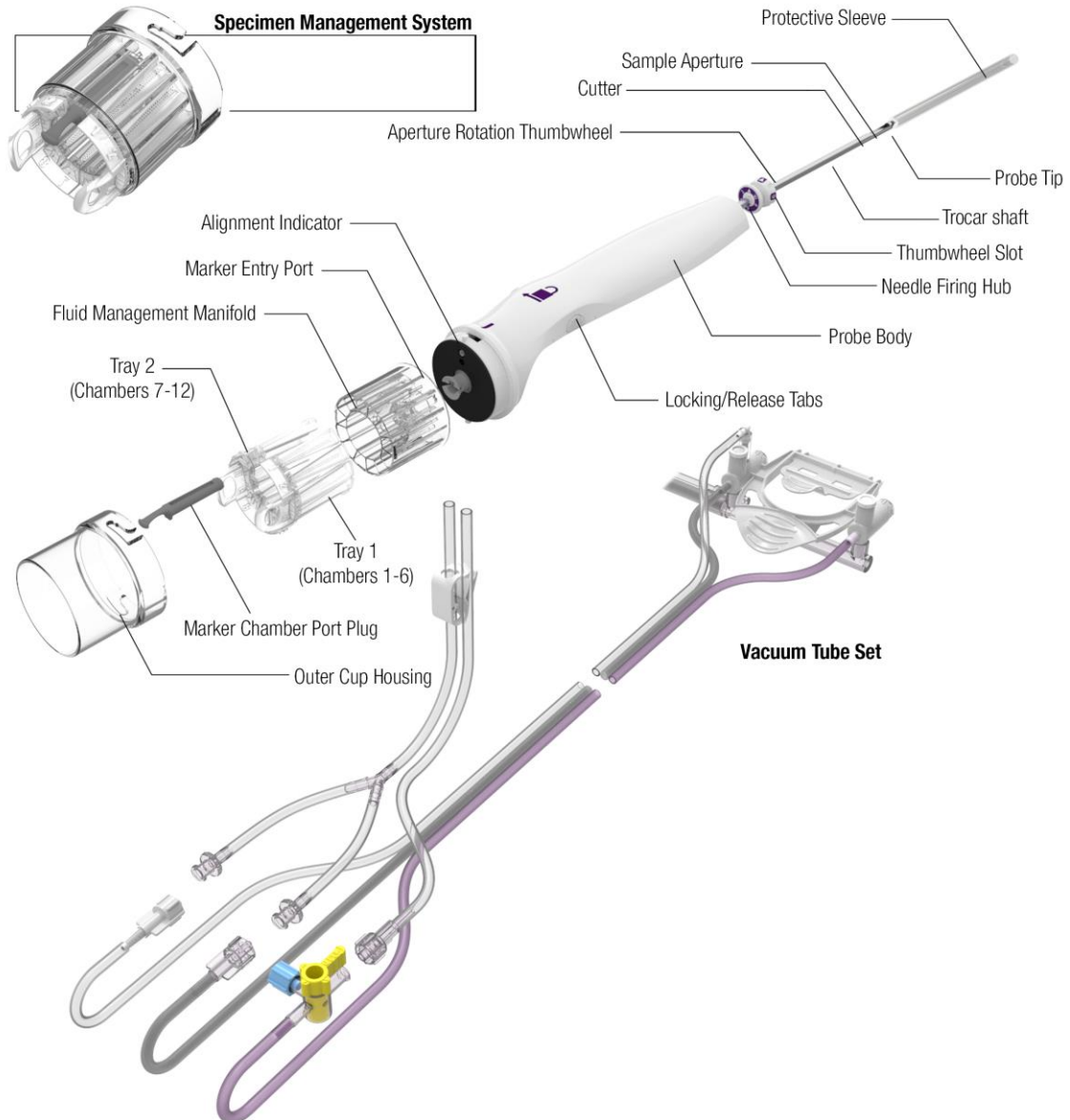



**Figure 6. Vacuum Tube Set Illustration and Nomenclature**

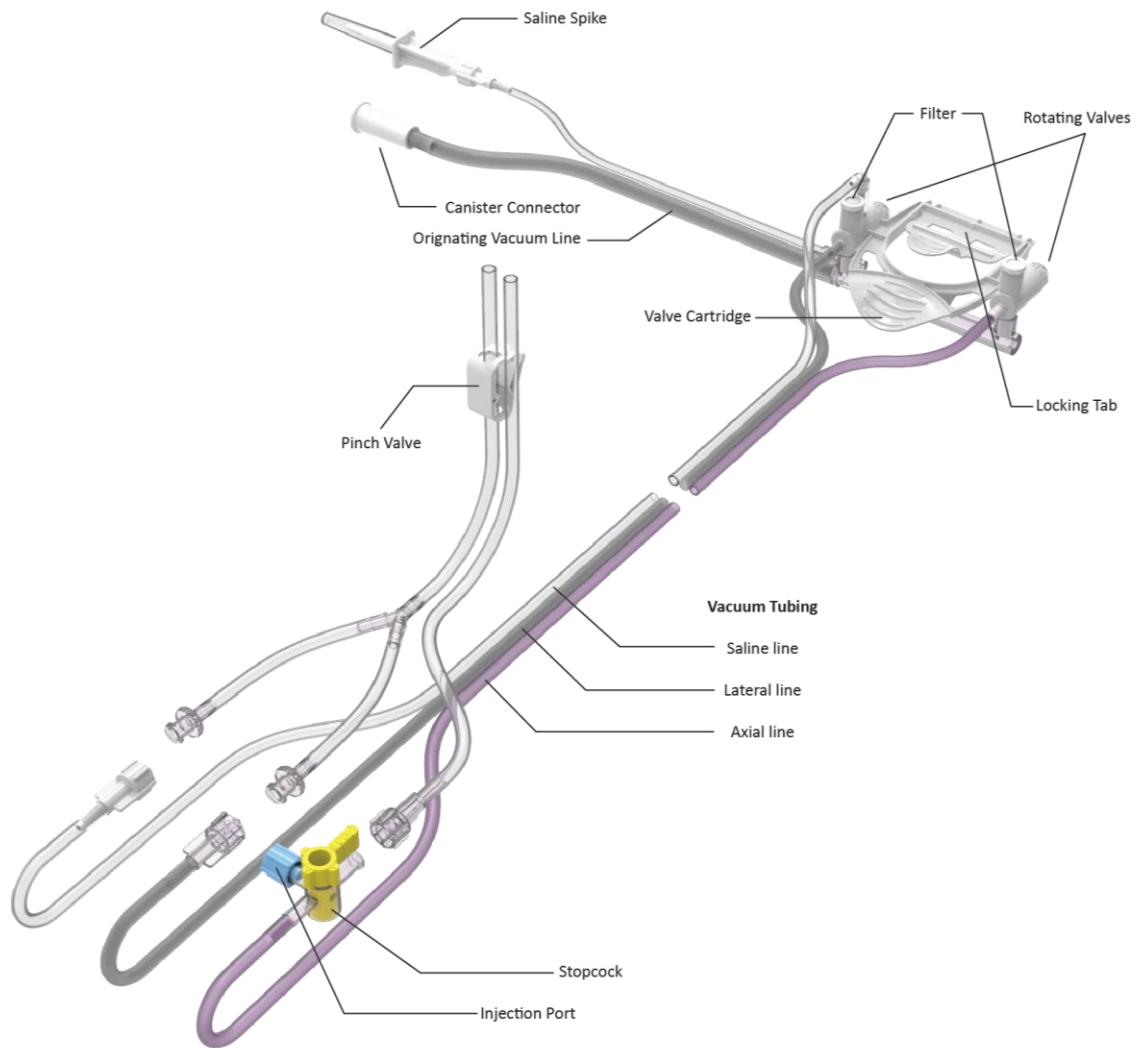
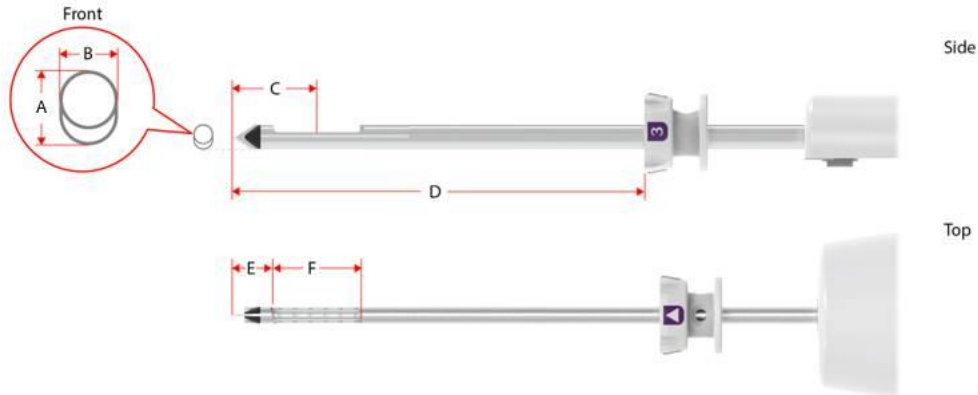

**Table 1. Mammotome revolve ST Probe Specifications**

| <i>Dimension (mm)</i>       | <i>8G 9cm<br/>MST0809</i> | <i>8G 12cm<br/>MST0812</i> | <i>8G 15cm<br/>MST0815</i> | <i>10G 9cm<br/>MST1009</i> | <i>10G 12cm<br/>MST1012</i> | <i>10G 15cm<br/>MST1015</i> |
|-----------------------------|---------------------------|----------------------------|----------------------------|----------------------------|-----------------------------|-----------------------------|
| <b>A: Needle Height</b>     | 5.6                       | 5.6                        | 5.6                        | 4.9                        | 4.9                         | 4.9                         |
| <b>B: Needle Width</b>      | 4.4                       | 4.4                        | 4.4                        | 3.45                       | 3.45                        | 3.45                        |
| <b>C: Tip to Center</b>     | 21.0                      | 21.0                       | 21.0                       | 17.5                       | 17.5                        | 17.5                        |
| <b>D: Tip to Thumbwheel</b> | 91.5                      | 121.5                      | 151.5                      | 90.0                       | 120.0                       | 150.0                       |
| <b>E: Dead Space</b>        | 9.5                       | 9.5                        | 9.5                        | 8.0                        | 8.0                         | 8.0                         |
| <b>F: Aperture Length</b>   | 23.0                      | 23.0                       | 23.0                       | 19.05                      | 19.05                       | 19.05                       |
| <b>Fill Volume (cc)</b>     | 9                         | 9                          | 10                         | 8                          | 8                           | 8                           |
| <b>Firing Distance</b>      | 19.3                      | 19.3                       | 19.3                       | 19.3                       | 19.3                        | 19.3                        |



**Figure 7. Mammotome revolve ST Probe Illustrations**



### **U/S Probe and Vacuum Tube Set**

The U/S Probe (along with its integrated components: Specimen Management System and Vacuum Tube Set) is a sterile, single-patient use device that may be used with imaging guidance to excise a tissue sample for diagnosis. The probe is designed to be loaded onto the U/S holster. The body of the probe contains a locking tab to secure the probe to the U/S holster. The probe consists of an outer trocar shaft and an inner cutter in a distal sample aperture. The sample aperture can be manually rotated by using the wrist to rotate the probe/holster assembly to the desired orientation.

The probe comes packaged with an attached vacuum tube set. The vacuum tube set connects the probe to a vacuum source through the surgical side of a vacuum canister. This allows fluid collected from the probe to be drained into the canister. The tube set has three points of attachment: 1) to the control module vacuum connection slot, 2) to the vacuum canister port, and 3) to a saline bag.

For further convenience, the probe includes a Specimen Management System consisting of 12 proximal specimen collection chambers. Each collection chamber is designed to capture and hold excised tissue. The specimen collection chambers are designed to be removed from the fluid management manifold in two separate trays (of six chambers each). If desired, the tissue can remain in the chambers to be directly imaged in the post-biopsy specimen radiograph.

A biopsy site identifier may be used in conjunction with the Mammotome revolve U/S probes to mark the location of the biopsy procedure. In the event of removal of evidence of abnormality, it is strongly recommended that a marking device be placed to mark the biopsy site in case follow-up is required.

**Figure 8. U/S Probe and Vacuum Tube Set Illustration and Nomenclature**

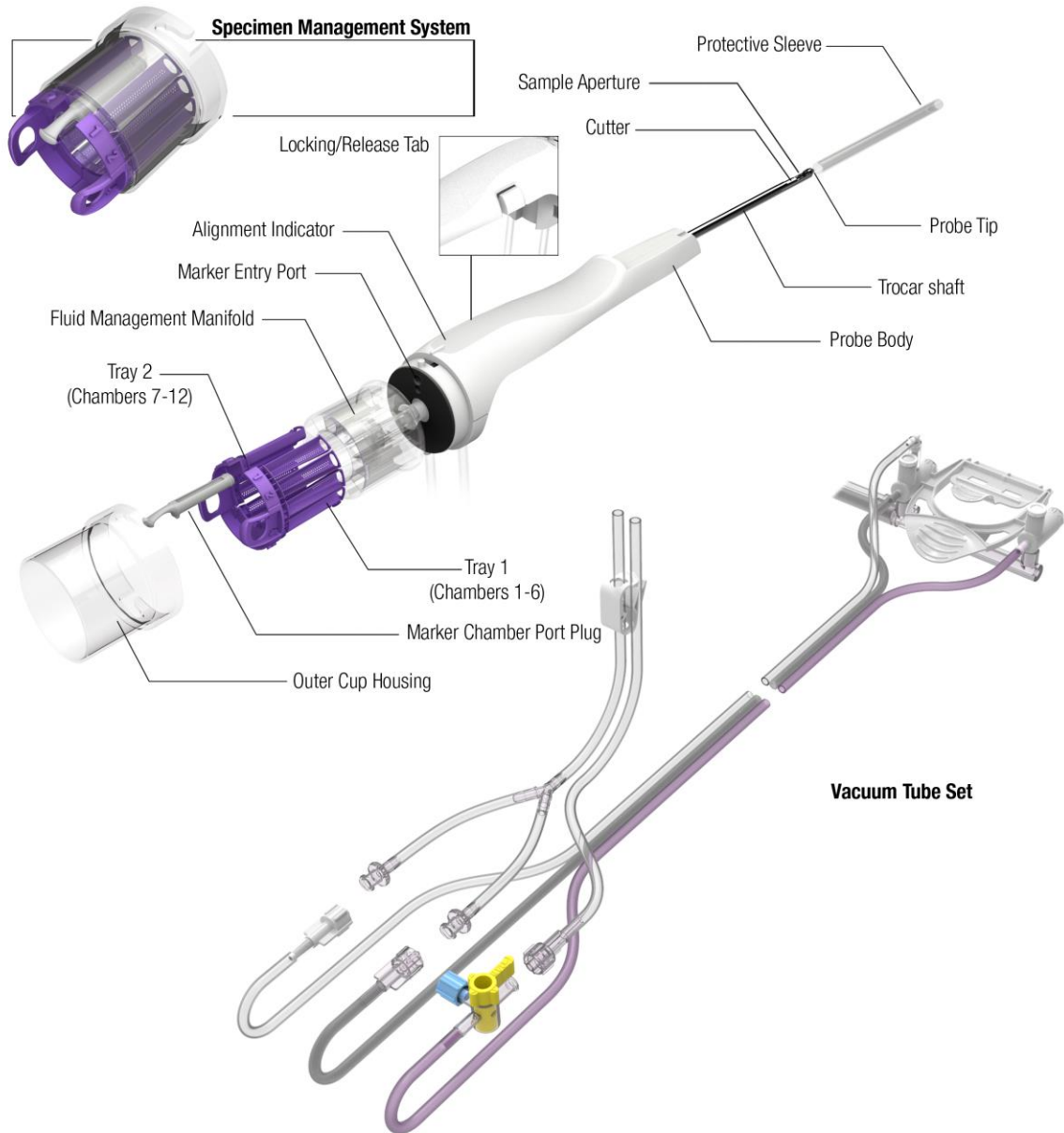

**Table 2. Mammotome revolve U/S Probe Specifications**

| <i>Dimension (mm)</i>     | <b>8G<br/>MHUS08</b> | <b>10G<br/>MHUS10</b> |
|---------------------------|----------------------|-----------------------|
| <b>A: Needle Height</b>   | 5.6                  | 4.9                   |
| <b>B: Needle Width</b>    | 4.4                  | 3.45                  |
| <b>C: Tip to Center</b>   | 21.0                 | 17.5                  |
| <b>D: Needle Length</b>   | 123.55               | 124.04                |
| <b>E: Dead Space</b>      | 9.5                  | 8.0                   |
| <b>F: Aperture Length</b> | 23.0                 | 19.05                 |
| <b>Fill Volume (cc)</b>   | 9                    | 8                     |

**Figure 9. Mammotome revolve U/S Probe Illustrations**

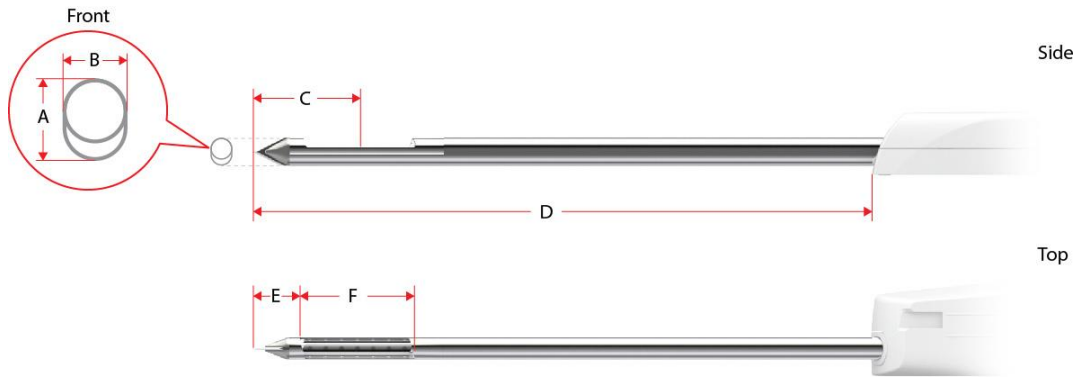

### **EX Probe, Vacuum Tube Set, and Sleeve**

The EX Probe (along with its integrated components: Specimen Management System, Vacuum Tube Set, and Optional Sleeve) is a sterile, single-patient use device that may be used with imaging guidance to excise a tissue sample for diagnosis. The probe is designed to be loaded onto the EX holster. The body of the probe contains a locking tab to secure the probe to the EX holster. The probe consists of an outer trocar shaft and an inner cutter in a distal sample aperture. The sample aperture can be manually rotated by using the wrist to rotate the probe/holster assembly to the desired orientation.

The probe comes packaged with an attached vacuum tube set. The vacuum tube set connects the probe to a vacuum source through the surgical side of a vacuum canister. This allows fluid collected from the probe to be drained into the canister. The tube set has three points of attachment: 1) to the control module vacuum connection slot, 2) to the vacuum canister port, and 3) to a saline bag.

For further convenience, the probe includes a Specimen Management System consisting of 4 proximal specimen collection chambers. Each collection chamber is designed to capture and hold excised tissue. The specimen collection chambers are designed to be removed from the fluid management manifold in four separate trays, three large and one single tray.

The MHEX08S EX probe comes packaged with a Holster sleeve. The sleeve connects to the holster and covers the reusable EX Holster and a portion of the Holster cable.

**Figure 10. EX Probe, Vacuum Tube Set, and Sleeve Illustrations and Nomenclature**

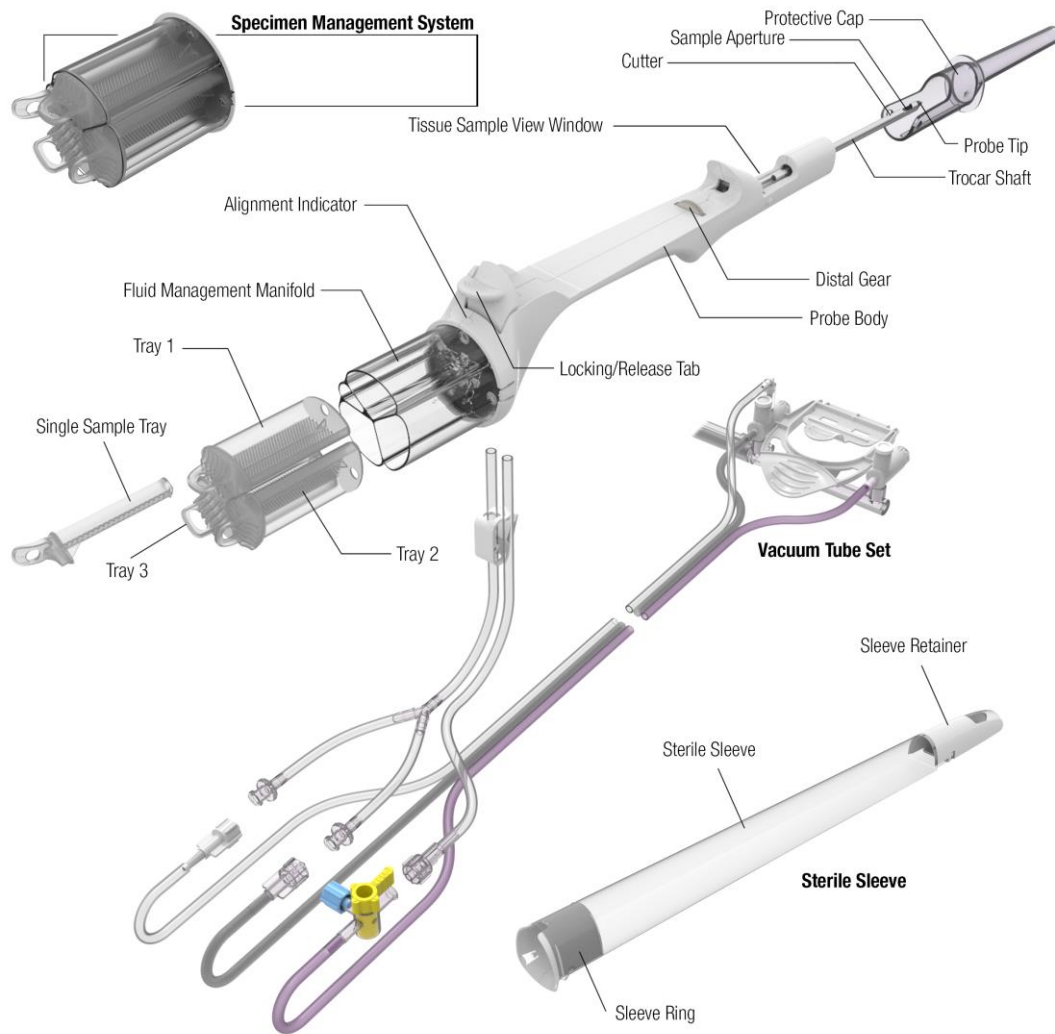

**Table 3. Mammotome revolve EX Probe Specifications**

| <i>Dimension (mm)</i>     | <b>8G<br/>MHEX08 AND MHEX08S</b> |
|---------------------------|----------------------------------|
| <b>A: Needle Height</b>   | 5.99 mm (6.0)                    |
| <b>B: Needle Width</b>    | 4.26 mm (4.3)                    |
| <b>C: Tip to Center</b>   | 23.3 mm                          |
| <b>D: Needle Length</b>   | 92 mm                            |
| <b>E: Dead Space</b>      | 10.8 mm                          |
| <b>F: Aperture Length</b> | 25.0 mm                          |
| <b>Fill Volume (cc)</b>   | 9                                |

**Figure 11. Mammotome revolve EX Probe Illustrations**

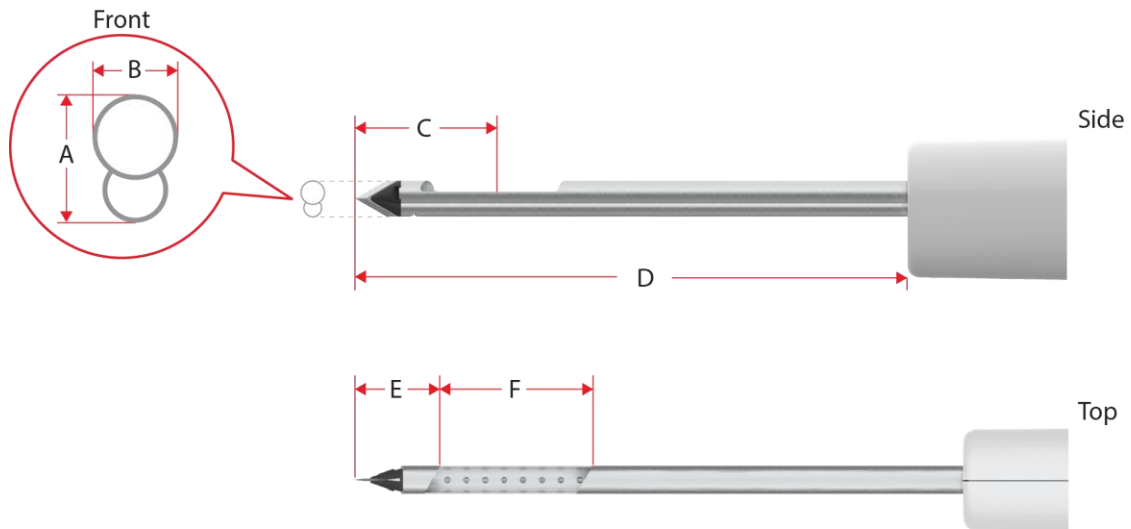

### **Input Devices**

The buttons used to activate the clinical functions of the Mammotome revolve Dual Vacuum-Assisted Biopsy System are located on an input device. Three input devices are available for use with the system:

1. Holster (ST or U/S or EX)
2. Remote Footswitch (optional)
3. Remote Keypad (optional)

Except for arming and firing the holster/probe assembly, only one input device can be active at a time. Although a remote footswitch or remote keypad can be used, arming and firing the device (ST only) can only be done using the ST holster buttons. An input device can be connected to the control module before or after powering on the system.

**NOTE:** For U/S and EX only: Use the remote footswitch when experiencing difficulty (e.g., muscle strain) after repeated use of the holster buttons.

### ***ST Holster***

The Mammotome revolve ST Holster is a non-sterile, reusable instrument with one electrical cable for transmitting information to the control module. The ST Holster communicates with the control module and ST probe to drive the basic functionality for the procedure, including the rotation, advancement and retraction of the cutting mechanism, and specimen management system rotation. The aperture rotation knobs can be used to manually turn and orient the sample aperture as desired. Five fingertip-operable buttons on the ST Holster control the functions of the Mammotome revolve Dual Vacuum-Assisted Biopsy System and are identical on each side of the holster.

**Figure 12. ST Holster Illustration and Nomenclature**

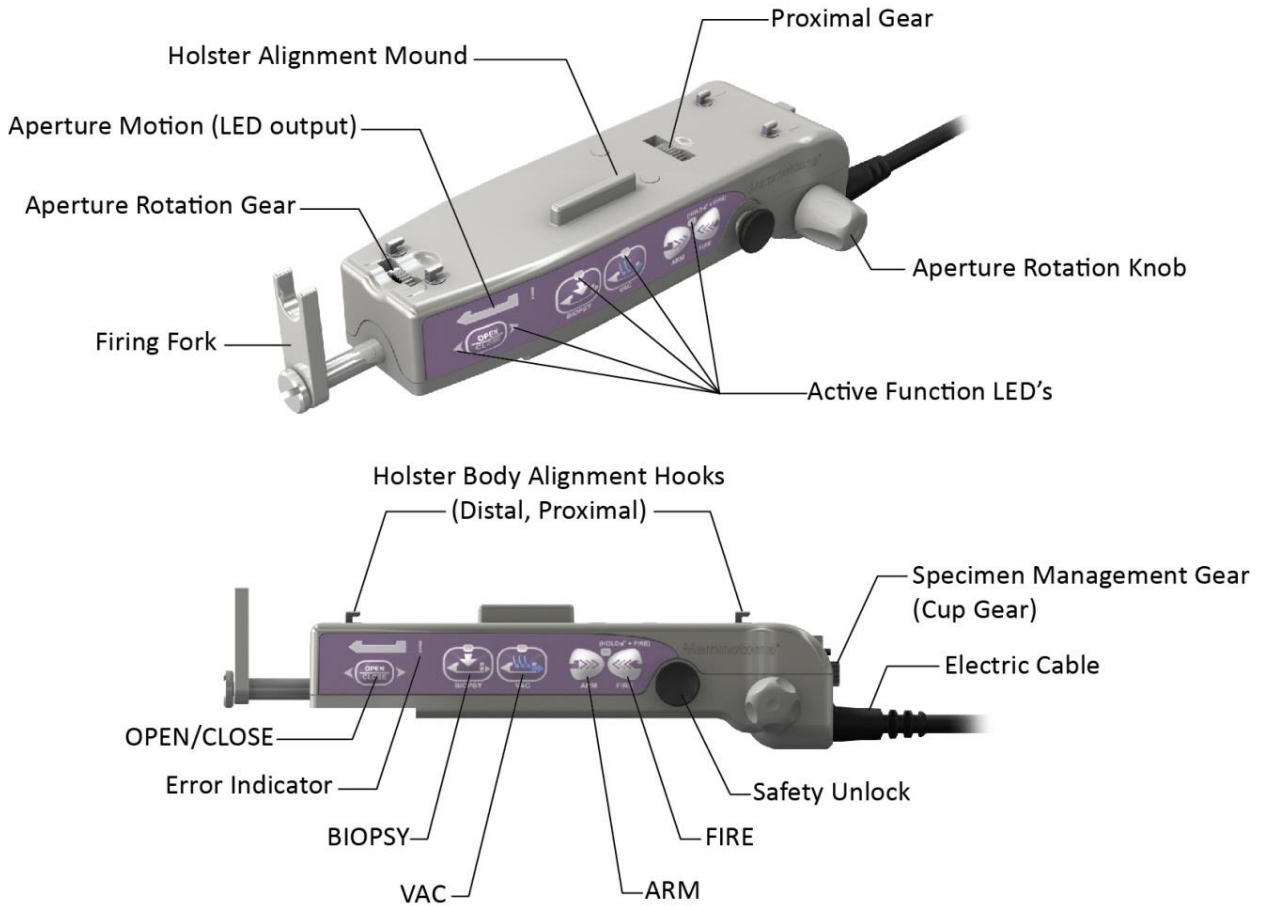

**NOTE:** Figure 12 shows the left-hand side of the holster. The placement of the holster buttons on the right-hand side of the holster is directly opposite those on the left-hand side.

### ***U/S Holster***

The Mammotome revolve U/S Holster is a non-sterile, reusable instrument with one electrical cable for transmitting information to the control module. The U/S Holster communicates with the control module and U/S probe to drive the basic functionality for the procedure, including the advancement and retraction of the cutting mechanism and specimen management system rotation. The sample aperture can be manually rotated by using the wrist to rotate the probe/holster assembly to the desired orientation. Three fingertip-operable buttons on the U/S Holster control the functions of the Mammotome revolve Dual Vacuum-Assisted Biopsy System.

**Figure 13. U/S Holster Illustration and Nomenclature**

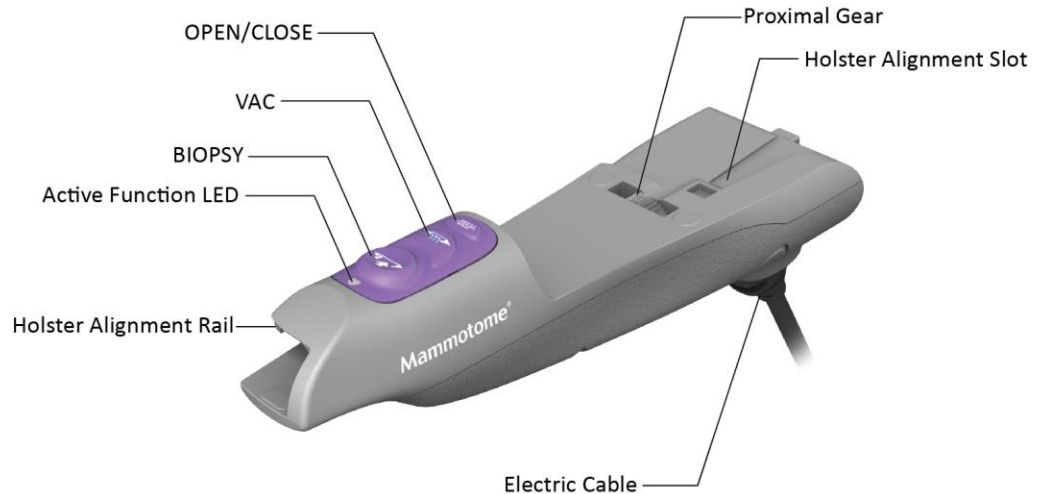

***EX Holster***

The Mammotome revolve EX Holster is a non-sterile, reusable instrument with one electrical cable for transmitting information to the control module. The EX Holster communicates with the control module and EX probe to drive the basic functionality for the procedure, including the advancement and retraction of the cutting mechanism. The sample aperture can be manually rotated by using the wrist to rotate the probe/holster assembly to the desired orientation. Three fingertip-operable buttons on the EX Holster control the functions of the Mammotome revolve Dual Vacuum-Assisted Biopsy System.

**Figure 14. EX Holster Illustration**

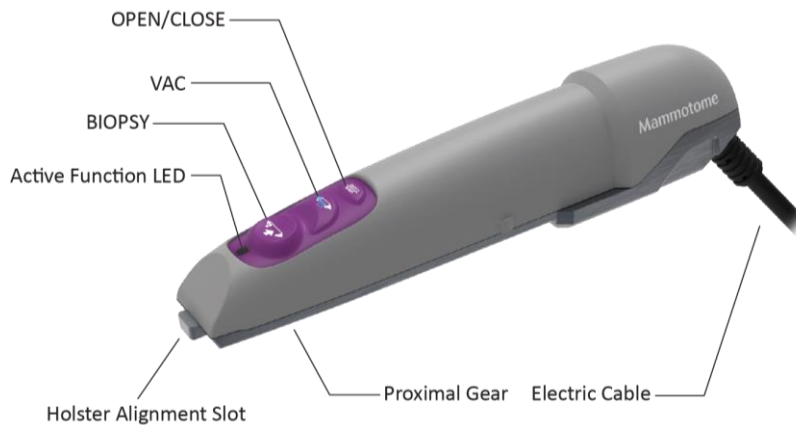

***EX Specific Holster Functions***

- **OPEN/CLOSE** button. Opens and closes the cutter location in the aperture.
  - Post-Biopsy activation transfers the tissue sample from the viewing window to the collection chamber.
- **BIOPSY** button. Activates the cutter for tissue sampling.
  - Press and release for single specimen acquisition.
  - Press and hold for continuous sampling.

**NOTE:** The sample aperture can be manually rotated by using the wrist to rotate the probe/holster assembly to the desired orientation.

**NOTE:** The sample collection area can be manually rotated by holding the outside of the sample collection area to move to next desired chamber.

- **VACUUM (VAC)** button. Activates vacuum aspiration and probe clearing.
  - Press and hold to activate vacuum aspiration for the duration of the press. The cutter retracts and vacuum is applied for up to 15 seconds.
  - Press and immediately release to activate a short vacuum and saline pulse. If a specimen is not transported into its chamber, use this function to bring the clogged tissue or fluid into that chamber, rather than indexing to the next sequential chamber.

**NOTE:** Post-Biopsy activation will transfer the tissue sample from the viewing window to the collection chamber.

### **Remote Footswitch**

The remote footswitch is a non-sterile, reusable device with a power cord to transmit information to the control module. It provides three activation buttons for clinical functions.

**Figure 15. Remote Footswitch Illustration and Nomenclature**

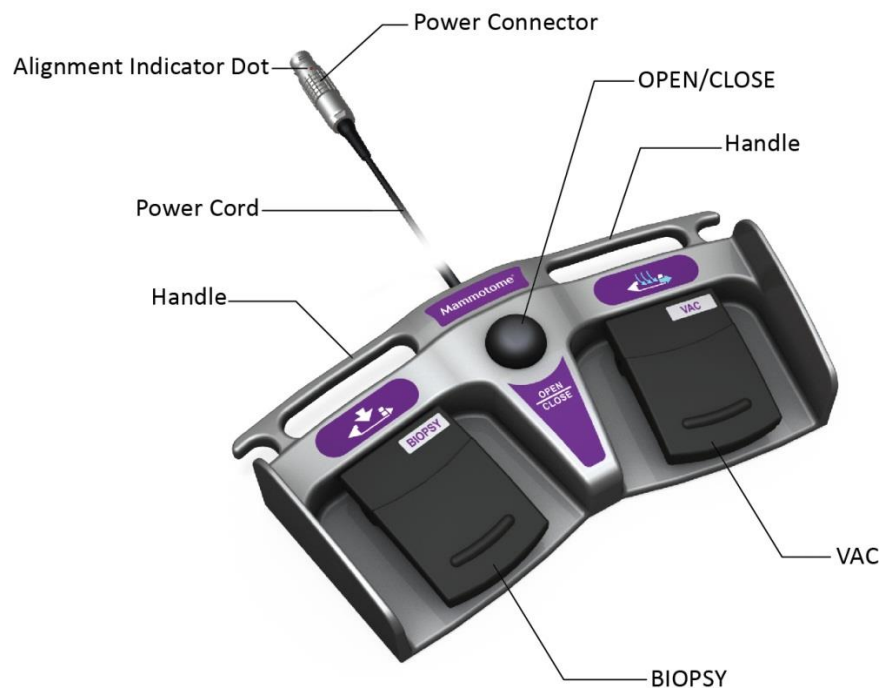

### **Remote Keypad**





The remote keypad is a non-sterile, reusable device that uses a power cord to transmit information to the control module. It features three finger-tip operable buttons for clinical functions.

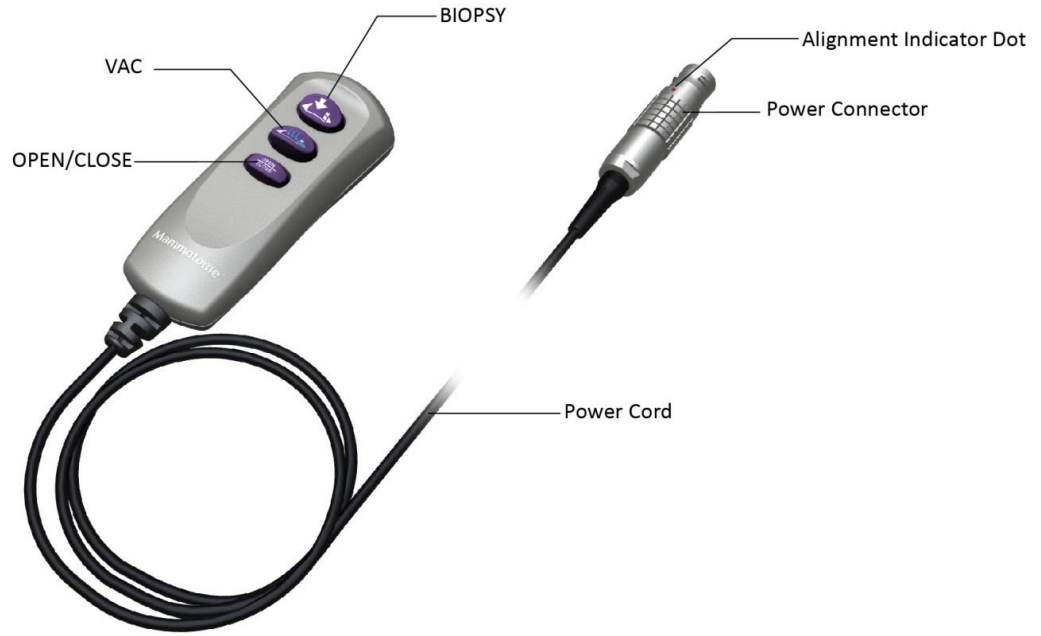



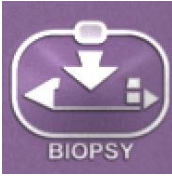





**Figure 16. Remote Keypad Illustration and Nomenclature**







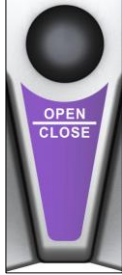



**Table 4. Input Device Button Operations for ST and U/S Only**



| <i>Button</i>        | <i>Description</i>                                                                                                                                                                                                                                                                                                                                                                                                                                                                                                                                                                                                                                                                                                                | <i>ST Holster</i>                                                                 | <i>U/S Holster</i>                                                                 | <i>Remote Footswitch</i>                                                            | <i>Remote Keypad</i>                                                                |
|----------------------|-----------------------------------------------------------------------------------------------------------------------------------------------------------------------------------------------------------------------------------------------------------------------------------------------------------------------------------------------------------------------------------------------------------------------------------------------------------------------------------------------------------------------------------------------------------------------------------------------------------------------------------------------------------------------------------------------------------------------------------|-----------------------------------------------------------------------------------|------------------------------------------------------------------------------------|-------------------------------------------------------------------------------------|-------------------------------------------------------------------------------------|
| <p><b>BIOPSY</b></p> | <p>Activates tissue sampling.</p> <p>When the BIOPSY button is depressed, the specimen management system first indexes to the next available chamber, to receive the attempted specimen.</p> <ul style="list-style-type: none"> <li>• Press and release for single specimen acquisition.</li> <li>• Press and hold for continuous sampling.</li> </ul> <p><b>ST NOTE:</b> The sample aperture is oriented by manually rotating the ST holster aperture rotation knob or the ST probe aperture rotation thumbwheel to the desired position around the sample aperture.</p> <p><b>U/S NOTE:</b> The sample aperture can be manually rotated by using the wrist to rotate the probe/holster assembly to the desired orientation.</p> |  |  |  |  |

| <b>Button</b>                | <b>Description</b>                                                                                                                                                                                                                                                                                                                                                                                                                                                                                                     | <b>ST Holster</b>                                                                   | <b>U/S Holster</b>                                                                   | <b>Remote Footswitch</b>                                                              | <b>Remote Keypad</b>                                                                  |
|------------------------------|------------------------------------------------------------------------------------------------------------------------------------------------------------------------------------------------------------------------------------------------------------------------------------------------------------------------------------------------------------------------------------------------------------------------------------------------------------------------------------------------------------------------|-------------------------------------------------------------------------------------|--------------------------------------------------------------------------------------|---------------------------------------------------------------------------------------|---------------------------------------------------------------------------------------|
| <b>VAC</b><br>(VACUUM)       | <p>Activates vacuum aspiration and probe clearing.</p> <ul style="list-style-type: none"> <li>Press and hold to activate vacuum aspiration for the duration of press. The cutter retracts and vacuum is applied for up to 15 seconds.</li> <li>Press and immediately release to activate a short vacuum and saline pulse. If a specimen is not transported into its chamber, use this approach to bring the clogged tissue or fluid into that chamber, rather than indexing to the next sequential chamber.</li> </ul> |    |    |    |    |
| <b>OPEN/</b><br><b>CLOSE</b> | <p>Opens and/or closes the cutter in the sample aperture.</p> <p><b>NOTE (ST only):</b> If the holster is the active input device, the blue LED arrow indicates the direction in which the cutter moves when the OPEN/CLOSE button is selected.</p>                                                                                                                                                                                                                                                                    |  |  |  |  |

**Table 5. Input Device Operations for EX Only**

| <i>Button</i>       | <i>Description</i>                                                                                                                                                                                                                                                                                                                                                                                                                                                                                                                                                                                                | <i>EX Holster</i>                                                                    | <i>Remote Footswitch</i>                                                              | <i>Remote Keypad</i>                                                                  |
|---------------------|-------------------------------------------------------------------------------------------------------------------------------------------------------------------------------------------------------------------------------------------------------------------------------------------------------------------------------------------------------------------------------------------------------------------------------------------------------------------------------------------------------------------------------------------------------------------------------------------------------------------|--------------------------------------------------------------------------------------|---------------------------------------------------------------------------------------|---------------------------------------------------------------------------------------|
| <b>BIOPSY</b>       | <p>Activates tissue sampling.</p> <p>When the BIOPSY button is pressed, the previous specimen advances to sample collection area.</p> <ul style="list-style-type: none"> <li>• Press and release for single specimen acquisition.</li> <li>• Press and hold for continuous sampling.</li> </ul>                                                                                                                                                                                                                                                                                                                   |    |    |    |
| <b>VAC (VACUUM)</b> | <p>Activates vacuum aspiration and probe clearing.</p> <ul style="list-style-type: none"> <li>• Press and hold to activate vacuum aspiration for the duration of press. The cutter retracts and vacuum is applied for up to 15 seconds.</li> <li>• Press and immediately release to activate a short vacuum and saline pulse. If a specimen is not transported into its chamber, use this approach to bring the clogged tissue or fluid into that chamber.</li> </ul> <p><b>NOTE:</b> If a biopsy has been attempted before button press, the previous specimen will transport to the sample collection area.</p> |   |   |  |
| <b>OPEN/ CLOSE</b>  | <p>Opens and/or closes the cutter in the sample aperture.</p> <p><b>NOTE:</b> If a biopsy has been attempted before button press, the previous specimen will transport to the sample collection area.</p>                                                                                                                                                                                                                                                                                                                                                                                                         |  |  |  |

**Table 6. Input Device Button Operations for ST Holster Only**

| <i>Button</i>                 | <i>Description</i>                                                                                                                                                                                                                                | <i>ST Holster</i>                                                                   |
|-------------------------------|---------------------------------------------------------------------------------------------------------------------------------------------------------------------------------------------------------------------------------------------------|-------------------------------------------------------------------------------------|
| <b>ARM</b>                    | <p>Retracts the trocar shaft (needle).</p> <ul style="list-style-type: none"> <li>Press and hold ARM until blue LEDs flash (about 1 second) to automatically retract the trocar shaft to the pre-fire position.</li> </ul>                        |  |
| <b>SAFETY UNLOCK and FIRE</b> | <p>Fires the trocar shaft (needle).</p> <ul style="list-style-type: none"> <li>Press and hold the mechanical safety unlock button while simultaneously pressing the FIRE button to advance the trocar shaft to the post-fire position.</li> </ul> |  |

**Detachable Components**

The Bemis 800cc **vacuum canister** is a non-sterile, single-patient use device used with the Mammotome revolve Dual Vacuum-Assisted Biopsy System to collect fluid from a biopsy procedure. Refer to [Chapter 4 \(ST only\)](#), [Chapter 5 \(U/S only\)](#), or [Chapter 6 \(EX only\)](#) for instructions for use during a procedure based on procedure type.

**Figure 17. Vacuum Canister Detachable Component**



The Mammotome revolve **probe guide (ST only)** is a sterile, single-patient use device used with a Mammotome revolve ST probe during a stereotactic procedure. It is designed to guide and stabilize the probe trocar shaft. Refer to [Chapter 4: Stereotactic \(ST\) Instructions for Use](#) for instructions for use during a procedure.

**Figure 18. Fork-Style Probe Guide**



**Figure 19. Button-Style Probe Guide**



## **System Software**

The Mammotome revolve Dual Vacuum-Assisted Biopsy System arrives loaded with applicable system software. System software functions are described in [Chapter 8: Software Description](#).

## Chapter 3 INITIAL INSTALLATION AND GETTING STARTED

**Please read all information carefully. Failure to properly follow the instructions may lead to serious surgical consequences.**

**All information in this guide applies to ST, U/S, and EX modalities unless otherwise stated.**

**PRECAUTION:** Inspect each item (e.g., Control Module, Cart, etc.) for damage before use. Do not use a damaged item.

**NOTE:** It is recommended that the original shipping box and protective wrapping for each item be saved for future storage and/or transport of the item.

### Preventative Maintenance

The following table provides a visual guide for standard preventative maintenance activities.

| PM Activity                                      | Minimum Frequency |         |          |
|--------------------------------------------------|-------------------|---------|----------|
|                                                  | Each Use          | Monthly | Annually |
| Vacuum Tube on Top of Control Module             | X                 |         |          |
| Cables and Connectors                            | X                 |         |          |
| Front Shoulder Screw (ST only)                   | X                 |         |          |
| Cart Caster Locks                                | X                 |         |          |
| Control Module Securement to Cart                |                   | X       |          |
| Electrical Safety Checks (e.g., leakage current) |                   |         | X        |

- **Control Module:** Before each use, inspect the flexible vacuum source tube and connector for damage. Do not use the vacuum source tube if it shows signs of damage.
- **Cart:** Before starting the procedure, set the locks on the wheels and verify the cart is secure by pushing and pulling on the handle.
- **Assembly:** At least once a month, inspect the thumbscrews that attach the control module to the cart. Ensure the screws are properly tightened.
- **Holster:** Before use, inspect the holster electrical cable and cable connector for damage. Do not use the holster if wires are exposed or the outer cover is broken. After cleaning and disinfection per the included instructions in [Chapter 7: Cleaning and Disinfection](#), ensure the front shoulder screw is tight. If necessary, tighten the screw with a coin.

### Unpacking/Assembling the Mammotome revolve Control Module

- To unpack, lift the control module from the box and remove the protective wrapping.
- Items included in shipping box:
  - Mammotome revolve Dual Vacuum-Assisted Biopsy Control Module
  - Safety Information Booklet
  - Power Cord
  - Saline Pole
  - Flexible Vacuum Source Tube

## Unpacking the Cart

---

The cart comes fully assembled.

- Remove cart from packaging.
- The cart comes assembled with the Stereotactic Holster Docking Station on the right side of the cart and the Ultrasound Docking Station on the left side. To switch docking station locations, use a 4mm hex key to remove and reattach each docking station.
- Items included in the shipping box:
  - Cart
  - Two (2) Thumbscrews attached to the Cart

## Unpacking the EX Holder (Cart Detachable Component)

---

The EX Holder comes assembled.

- Remove EX Holder from packaging.
- The EX Holder will need to be attached to the cart, replacing the holder (docking station) on the left side of the cart. To switch docking stations, follow the instructions provided in the EX Holder box.
- Items included in the shipping box:
  - EX Holder (Holster Holder and Probe Holder)
  - Four (4) Screws (with washers)
  - 4mm Hex Key Tool
  - Removal and Attachment Instructions

## Placing the Control Module on the Cart

---

1. Place the Mammotome revolve Control Module on the cart, ensuring the feet of the control module are positioned in the recesses of the cart top base.
2. Secure the control module to the cart by tightening the two thumbscrews attached to the cart. The thumbscrews are positioned under the recess of the cart top base.
3. Thread the power cord through the center column of the cart.

**NOTE:** Before transporting the system, ensure the wheels are unlocked and that all cords and tubes are clear of the cart wheels.

**NOTE:** Before transporting the system, ensure that the footswitch, keypad, and holster are located on the designated position on the cart to ensure that nothing falls from the cart.

**WARNING:** To ensure adequate ventilation, position the control module at least 6" (15.24 cm) from all walls. Do not block the exhaust fan at the rear of the control module. Do not position the device where it is difficult to operate the mains disconnect device. The power switch is used for mains disconnect.

**NOTE:** When removing the Control Module from the cart, unplug the power cord, untighten the two thumbscrews, and lift the Control Module by the handle and beneath the vacuum connection slot.

**NOTE:** Use care in placing the Control Module on the cart to ensure accurate performance.



## Unpacking the Holster

---

Lift the holster from the box and remove the protective wrapping.

- Items included in the shipping box:
  - ST Holster with attached electrical cable
  - OR**
  - U/S Holster with attached electrical cable
  - OR**
  - EX Holster with attached electrical cable

**WARNING:** Before using the holster, inspect its electric cable for fraying or damage. Do not use the instrument if the cable shows signs of damage or wear or if the enclosure is broken.

## Unpacking the Remote Footswitch

---

Lift the device from the box and remove the protective wrapping.

- Items included in the shipping box:
  - Remote Footswitch with attached power cord.

## Unpacking the Remote Keypad

---

Lift the device from the box and remove the protective wrapping.

- Items included in the shipping box:
  - Remote Keypad with attached power cord.

## Setup

---

### 1. Powering on the Control Module

**NOTE:** If using the cart and control module as a unit, ensure they have been properly assembled and set up before attempting to power on the control module.

**WARNING:** To prevent any possibility of electrical shock, **do not use** the Control Module if it shows any signs of damage.

- a. Ensure that the power to the control module is off (**O**) before making electrical connections.

**NOTE:** Verify that the outlet provides the correct voltage for the Control Module before making any electrical connections.

- b. Plug the power cord into the grounded electrical outlet at the back of the control module. Plug the opposite end of the power cord into a grounded wall.

**WARNING:** To avoid the risk of electrical shock, this equipment must only be connected to a supply mains with protective earth.

**NOTE:** The Potential Equalization Conductor (identified by an inverted triangle) on the rear of the control module provides a direct connection between the electrical equipment and the potential equalization busbar of the electrical installation. This Potential Equalization Conductor is provided in accordance with requirements of section 8.6.7 of IEC 60601-1 Edition 3.1.

- c. Flip the On/Off switch at the back of the control module to the ON (I) position. Once the switch is in the ON position, the power button in the front illuminates **amber**, indicating the machine is receiving power but the control module is not active.
- d. Press the **amber** power button on the front of the control module until it illuminates GREEN. The title screen appears on the display and the system proceeds to the first software screen prompt.

**WARNING: DO NOT** touch exposed cord connectors or cord connector ports when the control module power is on (I).

**WARNING:** Do not touch exposed parts of connectors on the control module, holster, or touchscreen while simultaneously contacting the patient, as safety hazards may exist.

**WARNING:** To ensure adequate ventilation, position the control module at least 6" (15.24 cm) from all walls. Do not block the exhaust fan at the rear of the control module. Do not position the device where it is difficult to operate the mains disconnect device. The power switch is used for mains disconnect.

**NOTE:** Never use a sharp object to activate the touchscreen.

- e. If a holster has already been attached, the control module recognizes the device and displays a screen prompt to attach a probe. (See Step 6: Loading the Mammotome revolve Probe onto the Mammotome revolve Holster.) If no holster has been attached, the touchscreen interface on the control module displays prompt:



A holster must be attached via the holster connection port to proceed with setup.

## 2. Connecting the Holster to the Control Module

**NOTE:** Do not connect the holster to the control Module when the power is **On**.

- a. Align the red indicator mark on the holster electrical cable connector with the connection port on the front of the control module.
- b. Push the electrical cable connector into the connection port until an audible click is heard. Proper connection of the holster to the control module advances the software to the next screen prompt, "Attach Probe".

**NOTE:** Do not force the holster cable connector into its receptacle (Control Module connection port). If the holster cable connector is difficult to attach, ensure proper alignment to the receptacle before re-attempting to insert.



c. Place the holster in its designated docking station:

ST Side

U/S Side

EX Side

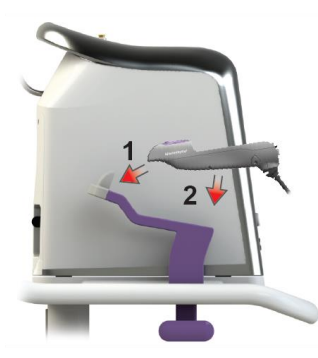

**NOTE:** To ensure the holster is secure in its docking station on the cart, ensure the probe tubing (if a probe is attached to the holster) and holster electric cable are out of the way and do not obstruct placement.

**WARNING:** Use care when placing the holster in its docking station, to ensure it does not slip out of its cradle.

**NOTE:** The cart arrives with the U/S docking station on the left side and the ST docking station on the right side. The two can be switched if desired. (See instructions for unpacking the cart.) The EX Holder (docking station) arrives **not** attached to the cart. Removal and Installation instructions and tools are provided in the EX Holder packaging.

3. (OPTIONAL) Attaching the EX Holder (Cart Detachable Component) to the Cart (Refer to the attachment instructions that are delivered with the EX Holder.)
4. (OPTIONAL) Connecting the Remote Footswitch to the Control Module

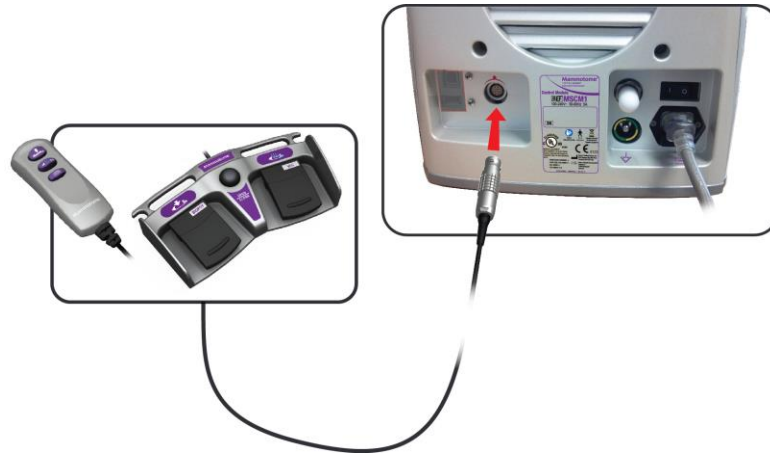

**NOTE:** See optional Step 4, above, and optional Step 5, below.

- a. Align the remote footswitch's power connector with the control module's remote device connection port (at the back of the control module) and push in until an audible click is heard.
- b. Place the remote footswitch on the cart's base (bottom) shelf for later use.

**NOTE:** Connecting the remote footswitch to the remote device connection port disables the buttons on the attached holster (except for arm/fire on the ST holster only). Disconnect the remote footswitch if the buttons on the holster or remote keypad are intended to be used.

#### 5. (OPTIONAL) Connecting the Remote Keypad to the Control Module

- a. Align the remote keypad's power connector with the control module's remote device connection port (at the back of the control module) and push in until an audible click is heard.
- b. Place the remote keypad in the storage bin at the back of the cart for later use.

**PRECAUTION:** Connecting the remote keypad to the remote device connection port disables the buttons on the attached holster (except for arm/fire on ST only). Disconnect the remote keypad if the buttons on the holster or remote footswitch are intended to be used.

#### 6. Connecting the Vacuum Canister to the Control Module

- a. Inspect the vacuum canister before use. Ensure the lid is free of any cracks and is tightly sealed onto the vacuum canister.

**NOTE:** The canister is single-use **only**.

- b. Place the assembled vacuum canister in the well at the top of the Mammotome revolve Control Module.

**NOTE:** Ensure that the canister and lid are correctly assembled to prevent a vacuum error. Incorrect assembly can prevent the system from completing initialization.

- c. Connect the control module's flexible vacuum source tube to the center vacuum port on the vacuum canister lid.
- d. Rotate the canister clockwise to pull the canister tube tightly against the Control Module to ensure the tube cannot touch the probe when docking and undocking.



- e. Visually inspect the control module's flexible vacuum source tube for signs of moisture, blood, or tissue inside the tube.

**WARNING:** The pressure differential created in the canister during the procedure can cause blood discharge.

**NOTE:** If any moisture, fluid, foam, or solid material is visible in the control module's flexible vacuum source tube, complete the procedure immediately, stop use of the control module immediately, and contact your local representative for assistance.

- f. Close off the other vacuum canister ports, except the patient port, with the attached covers.

#### 7. (OPTIONAL – EX ONLY) Connecting the Sleeve to the Mammotome revolve EX Holster

- a. Ensure the Mammotome revolve EX Holster is placed in the corresponding docking station.
- b. Remove the sleeve assembly from Mammotome revolve EX Probe packaging by holding the collar and rigid portion of the sleeve assembly.
- c. Press the sleeve firmly over the Mammotome revolve EX Holster while on the docking station, ensuring that the flat surface of the Sleeve aligns with the flat surface of the Holster.

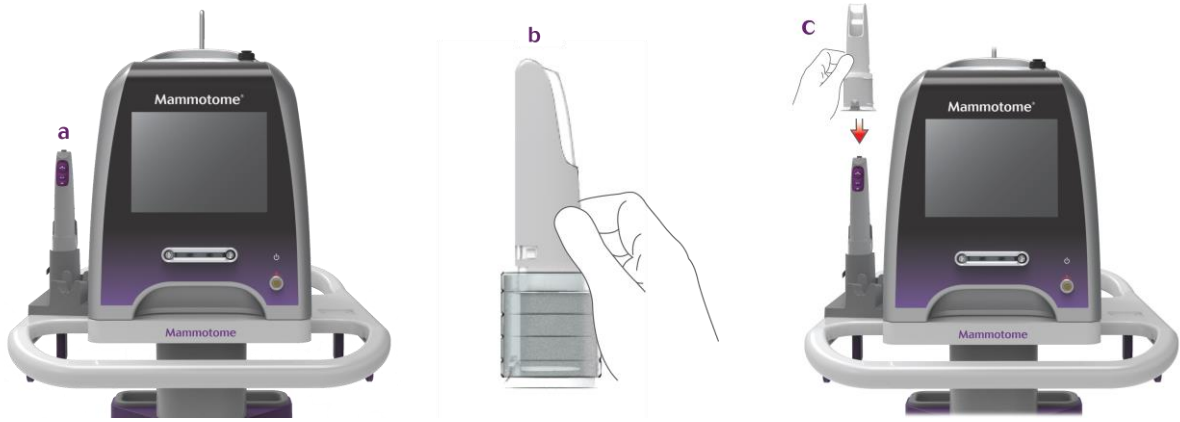

- d. When the sleeve is fully engaged with Mammotome revolve EX Holster, vertically lift them off the docking station. With the second hand, pull the assembly collar down the length of the Mammotome revolve EX Holster cable until the folded material on the collar has reached its full length, partially down the EX Holster cable.

**NOTE:** Ensure that the sleeve extends as far down the cable as its length allows.



**NOTE:** Ensure that the holster-probe assembly does not touch the cart during undocking and docking.

**NOTE:** If the holster portion of the EX docking station (holder) is not used to attach the sleeve to the holster and the attachment is performed by two hands, take care to prevent the holster from being dropped. Dropping the holster may damage the holster.

## 8. Loading the Mammotome revolve Probe onto the Mammotome revolve Holster

Note: Prior to use, inspect the protective packaging and device to verify that neither was damaged during shipment. If it appears the device has been compromised, do not use it. If a probe has been attached, the control module recognizes the device and proceeds to the system initialization screen. If no probe has been attached, the touchscreen interface displays a prompt:

# Attach Probe

- At this point, the user must attach a probe to the attached holster to proceed.

1. Instructions for attaching probe to holster (ST).
2. Instructions for attaching probe to holster (U/S).
3. Instructions for attaching probe to holster (EX).

**NOTE:** Do not attempt to attach the probe to the holster when the holster is still docked.

- This is a standby state, confirming to the user which devices are detected (attached). If an alternate input device is attached (such as a remote footswitch or remote keypad) it appears at the base (bottom) of the screen.

**NOTE:** All applicable input devices should be connected to the control module before loading the probe onto the holster. Ensure all connections are secure before loading the probe.

**NOTE:**

- Only the Mammotome revolve probes with the letters “ST” in the product code should be used with the Mammotome revolve ST Holster.
- Only the Mammotome revolve probes with the letters “US” in the product code should be used with the Mammotome revolve U/S Holster.
- Only the Mammotome revolve probes with the letter “EX” in the product code should be used with the Mammotome revolve EX Holster.

**NOTE:** Ensure a new, sterile probe is used to begin each procedure.

- The control module can be either in the on or off state when loading or removing a probe from the holster. If the control module is on, the touchscreen interface graphics confirm the probe is detected as attached to the holster and provide a prompt to proceed to initialization. (See [Chapter 8: Software Description](#) for software screen descriptions.)

**To load the probe, please follow the instructions below:**

- a. Before opening the probe packaging, inspect for the following items:
  - The label for the expiration date; do not use the device if the expiration date has passed.
  - The label to ensure the selected probe matches the holster and system to be used.

**WARNING:** Inspect the package and device to verify that each was not damaged during shipment. Do not use the device if the device or package appear compromised.

**NOTE:** Take special care to avoid dropping the probe packaging and possibly damaging the probe while transporting from storage.

- b. To open the sterile package, firmly grasp the plastic or rigid portion of the packaging. Where the arrows are placed, pull in the direction the arrow is pointing.
  - For ST and US Probe sterile packaging, remove the internal rigid plastic to access the ST or US Probe.
  - For EX Probe sterile packaging, unfold the internal folder to access the EX probe (and the sleeve, if included).
- c. Using sterile technique, remove the probe from the package. To avoid damage, do not flip the probe into the sterile field.

**NOTE:** Do not use the probe sleeve when the package/sterility of the sleeve is compromised.

**NOTE:** The probe is packaged with a protective sleeve (tip protector) over the trocar shaft. It is recommended that the protective sleeve remain on the trocar shaft until the user is ready to perform the tissue sampling procedure. Take care to avoid injury when removing the protective sleeve.

**NOTE:** Before use, remove and discard any retainers that secure the probe or tubing.

**NOTE:** Steps d. through g. below are specific to each probe:

- *ST Probe*
- or
- *U/S Probe*
- or
- *EX Probe*

### **ST Probe Only**

**NOTE:** Ensure the holster's firing fork is securely tightened before attempting to load the probe. If it is loose, use a coin to tighten it. **DO NOT OVER-TIGHTEN.**



- d. Before the probe is attached to the holster, ensure that the Specimen Management System's marker port is aligned with the alignment indicator on the probe body, as shown below. Ensure the SMS is fully seated on the probe, and that the tissue strips are fully seated in the SMS chambers.



**NOTE:** Ensure the probe's vacuum tubing is to the right of the holster electrical cable when loading the probe onto the holster.

- e. Grasp the probe body and engage the probe thumbwheel slot with the holster firing fork, then engage the probe alignment slot with the holster alignment mount.
- f. To attach, align the needle hub, press down, and forward. Do not force. Take care to avoid pinching the vacuum lines in the holster.



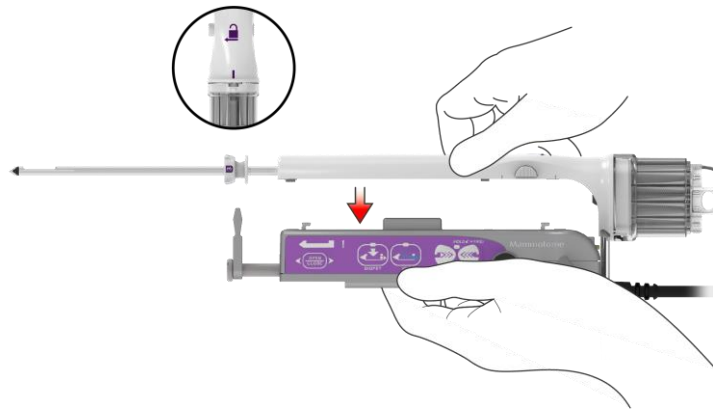

The locking mechanism engages to confirm attachment.

- g. Carefully place holster/probe assembly on the cart's ST docking station until you are ready to initiate the tissue sampling procedure.

***U/S Probe Only***

- d. Before the probe is attached to the holster, ensure that the Specimen Management System's marker port is aligned with the alignment indicator on the probe body, as shown below. Ensure the SMS is fully seated on the probe, and that the tissue strips are fully seated in the SMS chambers.



- e. Grasp the probe and slide the end of the probe body under the holster keypad (buttons).



- f. Push the probe body forward (distal) onto the holster until a click is heard, indicating the locking tab on the probe has engaged to the holster. Do not force. Take care to avoid pinching the vacuum lines in the holster.

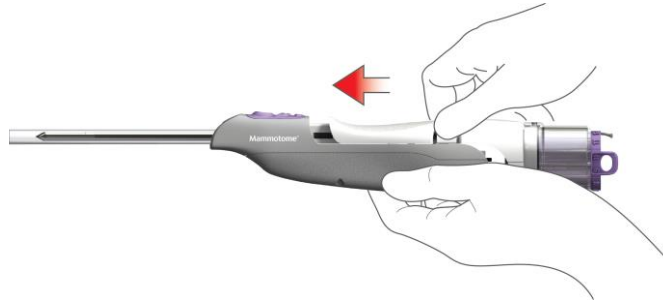

- g. Carefully place the holster/probe assembly on the cart's U/S docking station until the tissue sampling procedure is ready to be initiated.

**WARNING:** When placing or removing the holster/probe assembly to or from the docking station on the cart, ensure no contact is made between sterile and non-sterile surfaces (e.g., needle tip to cart surfaces or control module).

**EX Probe Only**

- d. Grasp the holster (with or without sleeve attached) and move toward the middle of the probe body.
- e. Align the front tab of MammoTome revolve EX Holster/Sleeve assembly with the front tab slot of MammoTome revolve EX Probe and push forward.

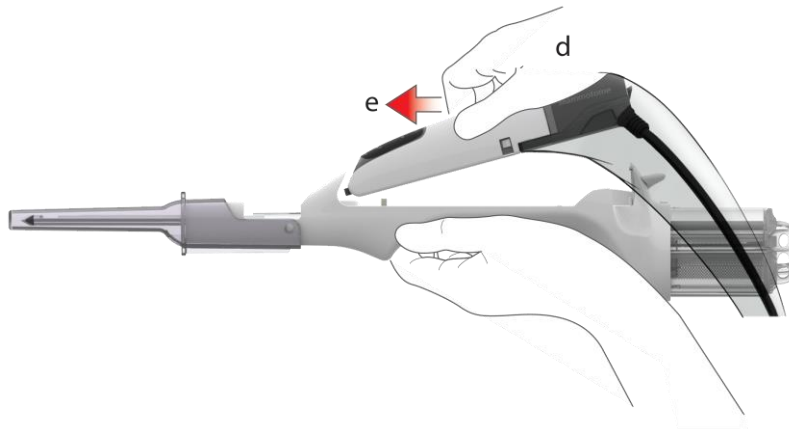

**NOTE:** The holster cable should be aligned with the cable slot on the left side of the probe.

- f. With the tab and tab slot aligned, rock the holster, pivoting on the tab, so that the back surface of the holster engages with the latching mechanism of the probe. An audible click may be heard, indicating the probe is attached to the holster.

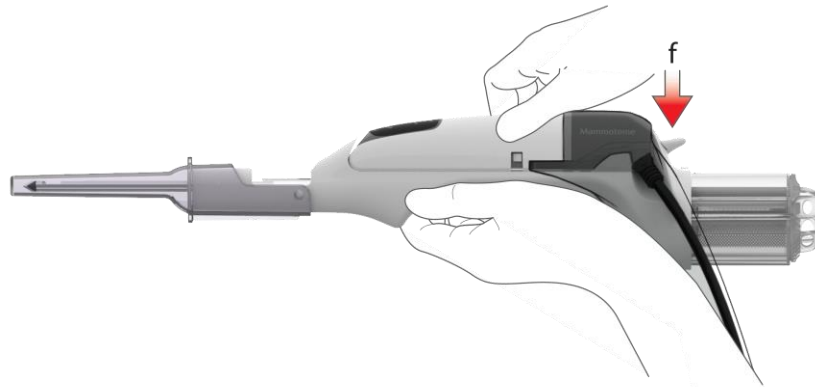

**NOTE:** Care should be taken to prevent the holster from being dropped during probe attachment. Dropping the holster may damage the holster.

- g. Carefully place the holster/probe assembly on the cart's EX Holder (docking station) for the probe until the tissue sampling procedure is ready to be initiated.
  - i. Place the tip of the sleeve protector (tip protector) into the semi-circular opening;
  - ii. Align the sleeve protector tab to the slot in the EX holder;
  - iii. Rock the holster/probe assembly downward, pivoting on the sleeve protector, until the holster/probe assembly is held by the holder.

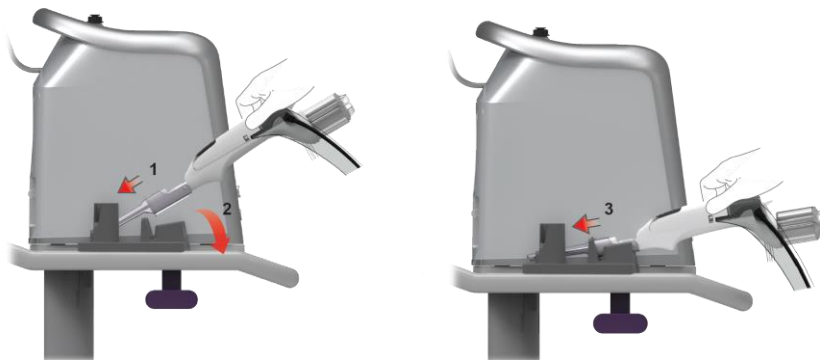

**WARNING:** When placing or removing the holster/probe assembly to or from the docking station on the cart, ensure no contact is made between sterile and non-sterile surfaces (e.g., Needle tip to cart surfaces or Control Module).

## 9. Connecting the Probe Vacuum Tube Set to the Mammotome revolve Dual Vacuum-Assisted Biopsy System

### a. Connecting the Vacuum Tube Set to the Saline Bag

- i. Remove the saline spike cover from the saline spike.

**NOTE:** Saline shall be used for the procedure for consistent tissue transport to collection area(s).

- ii. Connect the tubing line with the saline connection spike to a saline bag using standard technique.

**NOTE:** While connecting, removing, or transporting the saline bag, ensure to avoid spillage of saline onto the floor, control module, and in the keypad storage receptacle because

slippage or device damage can occur.

**NOTE:** Do not disconnect the tubing while the system is on.

- iii. Hang the saline bag on the saline pole at the back of the control module by moving the bag around the right side of the control module to the back.



**PRECAUTION:** The saline spike should be below the saline bag when the bag is hung on the saline pole, ensuring the spike tubing is not kinked. Separate the tubing lines between the canister connector and the saline spike if more tubing is needed.

**b. Connecting the Vacuum Tube Set to the Vacuum Canister**

Connect the canister connector on the originating vacuum line to the patient port of the vacuum canister lid by moving the connector around the left side of the control module to the lid.

*Control Module's flexible source tube to vacuum port (Step 5.c.)*

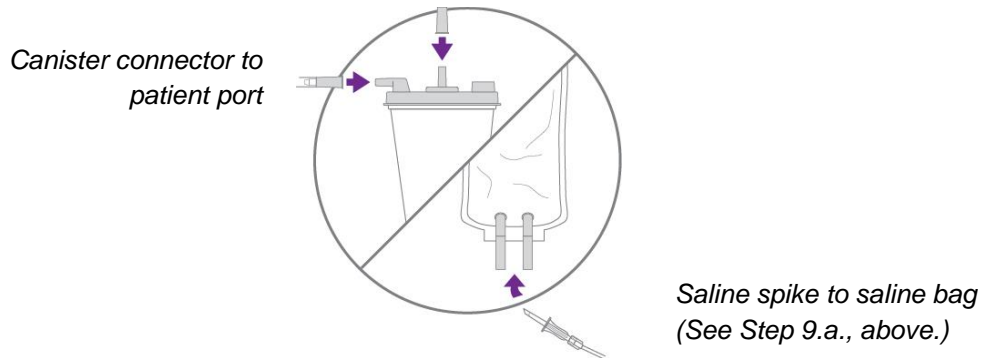

### c. Connecting the Vacuum Tube Set to the Control Module

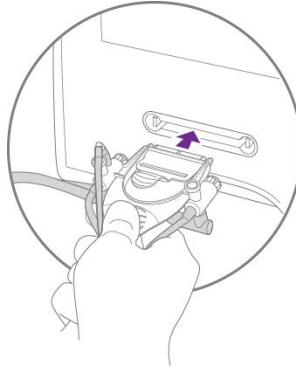

- i. Using sterile technique, remove the vacuum tube set from the probe package. To avoid damage, do not flip the device into the sterile field.

**Note:** Prior to use, remove and discard the retainers that secure the vacuum lines in the packaging.

- ii. Align the valve cartridge with the vacuum connection slot on the front of the control module, making sure the locking tab is facing up and the filters are above the tab.
- iii. Push the valve cartridge into the control module until it locks into place. Pull back on the valve cartridge to ensure that it is engaged.

**NOTES:** Follow tube set assembly notes, below:

**PRECAUTION:** Ensure that the connection tubes are not placed over the control module screen.

- Avoid pinching the vacuum lines during assembly to the control module.
- Do not force. Take care to avoid using excessive force when attaching the tube set.
- If using the cart, ensure the wheels are locked so the cart remains stable during use.
- Once the vacuum tube set has been connected, **do not** disconnect until ready to discard both the probe and the vacuum tube set.

**WARNING:** Ensure that the connection tubes are not placed over the docked handpiece.

## 10. Holster/Probe Assembly Initialization

- When the probe and vacuum tubing have been attached, the Touchscreen interface displays the initialization prompt:



- This prompt appears when the control module has been turned on and the system detects a probe is attached to a holster. If the system is booted up with a holster and probe attached, the startup process automatically proceeds to this screen.

**To initialize the system:**

- a. Touch the forward arrow on the touchscreen interface to proceed with initialization. When initialization is complete, the Touchscreen interface instructs the user to select an operating side at the holster (ST Only). For Ultrasound guided procedures (U/S and EX), the software goes directly from Initialization to the Ready Screen.

**NOTE:** Avoid pressing multiple buttons at once.

**PRECAUTION:** Leave the protective sleeve on the probe and keep hands away from the device during initialization to avoid injury.

**PRECAUTION:** Ensure that no connection tubes are placed over the control module to ensure safety, sterility, and correct operation.

**11. Select Side of Holster and Ready for Procedure (ST Only)**

- After the system proceeds through all initializations (cutter initialization, specimen management system initialization, vacuum initialization), the touchscreen interface of the control module displays a prompt advising the user to take action at the ST holster:

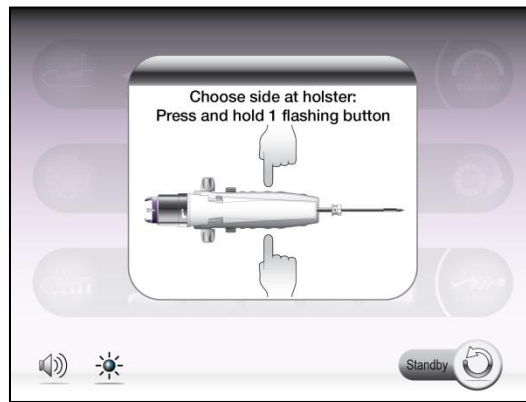

- The system displays this screen when the system is initialized, prompting the user to select which side of the ST holster will be used during the procedure. When this screen is displayed on the control module, the ST holster's LEDs slowly flash blue, prompting the user to touch any flashing button on either side of the holster to identify the desired operating side.

**To select the operating side of the ST holster:**

- a. Press and hold (~2 seconds) any flashing illuminated button on the **desired** operating side of the holster to continue.

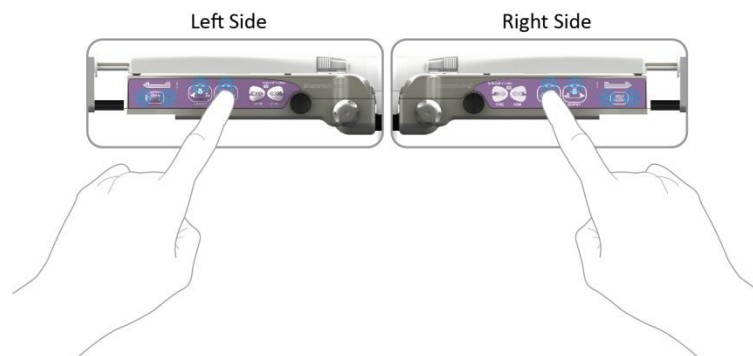

**NOTE:** The placement of the holster buttons on the right-hand side of the holster is opposite of those

on the left-hand side.

**To change the selected operating side of the ST holster:**

- a. Press and hold (~2 seconds) any button on the **opposite** side of the holster to prompt the system to change sides. The blue LEDs on both sides of the holster flash slowly, prompting the user to touch any button on either side of the holster to identify the desired operating side.

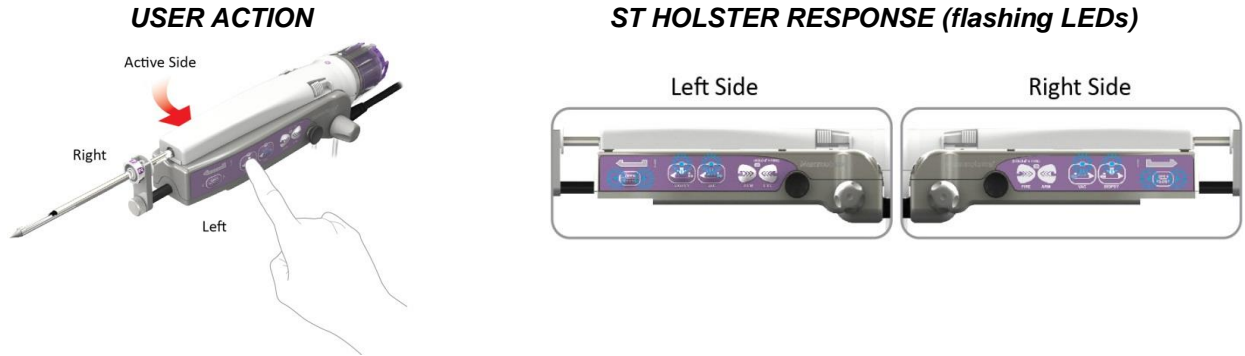

- b. Press and hold (~ 2 seconds) any illuminated (flashing) button on the **desired** operating side of the holster to continue.

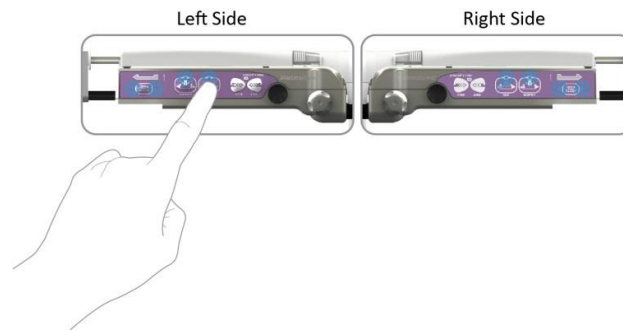

**NOTE:** After the ST probe has been loaded onto the ST holster and initialization has completed, take care to avoid the buttons on the holster until you are ready to perform the tissue sampling procedure.

**Once a side of the holster is selected (ST only), the touchscreen interface on the control module displays the Ready Screen (ST, U/S, and EX):**

- These screens are displayed on the control module when the system is fully initialized and ready to perform clinical functions. During tissue sampling or other clinical functions, the image on the screen graphically reflects the active function being performed by the system.

### ST and U/S



### EX Only

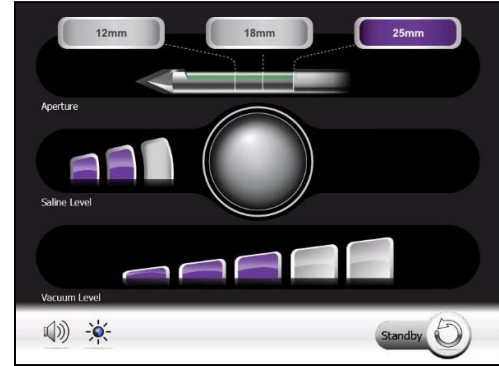

- On these screens, the user can adjust the default settings or continue with tissue sampling as described in [Chapter 4 \(ST\)](#), [Chapter 5 \(U/S\)](#), or [Chapter 6 \(EX\)](#).



## Chapter 4 STEREOTACTIC (ST) INSTRUCTIONS FOR USE

---

### Overview

---

This chapter provides a step-by-step description for collecting tissue samples using the Mammotome revolve Dual Vacuum-Assisted Biopsy System for a Stereotactic Guided Procedure.

### Mammotome revolve ST Probe and ST Holster

---

#### Summary Description

The Mammotome revolve ST Probe and ST Holster are used together to perform a stereotactic breast biopsy procedure.

- The holster is a non-sterile, reusable instrument with one electrical cable for transmitting information to the control module. The holster communicates with the control module and ST probe to drive basic functionality for the procedure. Buttons on the holster control the functions of the Mammotome revolve Dual Vacuum-Assisted Biopsy System.
- The ST Probe is a sterile, single-patient-use device that may be used with imaging guidance to excise a tissue sample for diagnosis. The probe is designed to be loaded onto the ST holster. The probe consists of an outer trocar shaft and an inner cutter in a distal sample aperture. The sample aperture can be rotated to the desired orientation using either the probe's aperture rotation thumbwheel or the ST Holster aperture rotation knobs. The probe comes packaged with an attached vacuum tube set to connect the probe to a vacuum source. The tube set has three points of attachment: 1) the control module vacuum connection slot, 2) the vacuum canister port, and 3) a saline bag. For further convenience, the probe includes a Specimen Management System consisting of 12 proximal specimen collection chambers. Each collection chamber is designed to capture and hold excised tissue. The specimen collection chambers are designed to be removed from the fluid management manifold in two separate trays (of six chambers each). If desired, the tissue can remain in the chambers to be directly imaged in the post-biopsy specimen radiograph.

**NOTE:** ST Probe and Holster Illustrations and Nomenclature are described in [Chapter 2: System Description](#).

#### ST Holster Button Description



- **OPEN/CLOSE** button. Opens and closes the cutter location in the aperture.
- **BIOPSY** button. Activates the cutter for tissue sampling.
  - Press and release for single specimen acquisition.
  - Press and hold for continuous sampling.

**NOTE:** When the BIOPSY button is pressed, the specimen management system first automatically indexes to the next available chamber to receive the attempted specimen.

**NOTE:** The sample aperture is oriented by manually rotating the ST holster aperture rotation knob or the ST probe aperture rotation thumbwheel to the desired position around the sample aperture.

- **VACUUM (VAC)** button. Activates vacuum aspiration and probe clearing.
  - Press and hold to activate vacuum aspiration for the duration of press. The cutter retracts, and vacuum is applied for up to 15 seconds.
  - Press and immediately release to activate a short vacuum and saline pulse. If a specimen is not transported into its chamber, use this approach to bring the clogged tissue or fluid into that chamber, rather than indexing to the next sequential chamber.
- **ARM** button. Retracts the trocar shaft (needle).
  - Press and hold ARM until the blue LEDs flash (about 1 second) to automatically retract the trocar shaft to the pre-fire position.
- **SAFETY UNLOCK** and **FIRE** buttons. Fire the trocar shaft (needle).
  - Press and hold the mechanical safety unlock button while simultaneously pressing the FIRE button to fire the trocar shaft.

**NOTE:** ST LED Holster states are described in [Chapter 12: Stereotactic \(ST\) Holster States](#).

**Figure 20. ST Holster LED Functions**

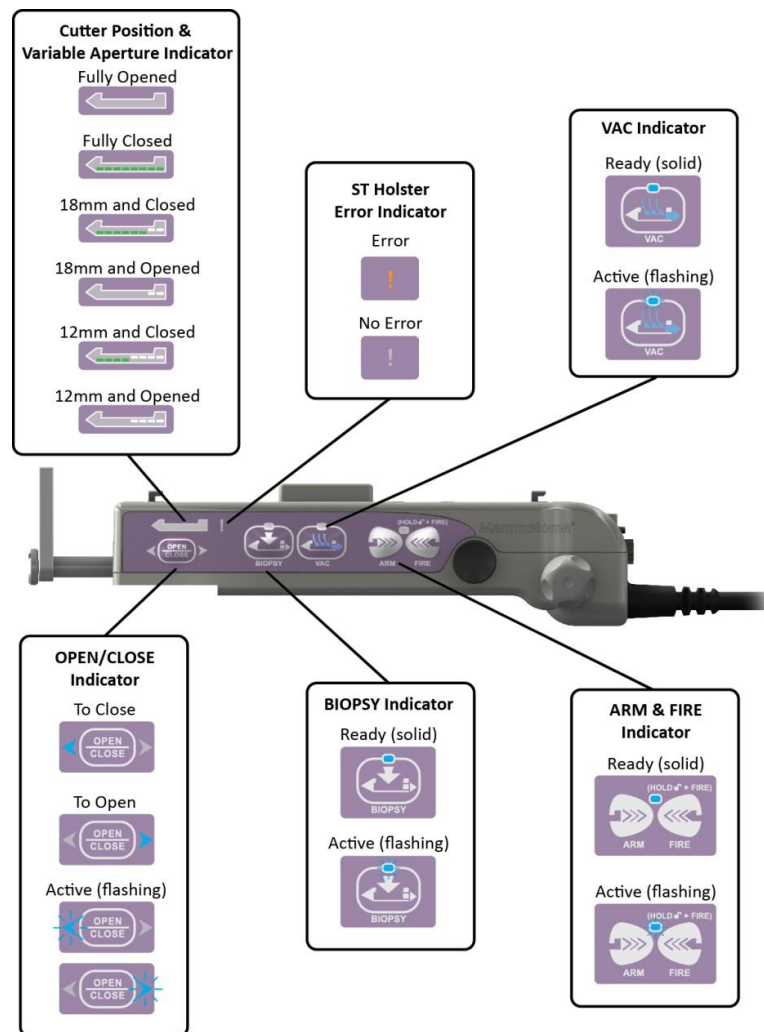

**NOTE:** Buttons on the opposite side of the holster are reversed.

**NOTE:** If a remote input device is attached (e.g. remote footswitch, remote keypad), the **blue** LEDs for BIOPSY, VAC, and OPEN/CLOSE on the holster illuminate in the Active (flashing) state only.

## Preparation for Use

---

To prepare the Mammotome revolve Dual Vacuum-Assisted Biopsy System for tissue sampling, refer to [Chapter 3: Initial Installation and Getting Started](#).

## Instructions for Use

---

### Steps for Tissue Sampling

1. Using sterile technique, insert a Mammotome revolve probe guide into the probe guide holder.
2. Manually rotate the probe guide, in the holder, as necessary to ensure that the peak on the probe guide is aligned with the 12 o'clock position on the probe's aperture rotation thumbwheel.

This ensures that the probe passes freely through the probe guide and orients the sample aperture to allow correct position alignment.
3. Remove the protective sleeve from the probe tip.

**WARNING:** Take care to avoid scraping of the needle tip against the protective sleeve and injury while removing the protective sleeve.
4. After aligning the probe trocar shaft with the probe guide, mount and secure the device assembly to the stereotactic stage.
5. Insert the probe into the probe guide by sliding the probe guide holder toward the aperture rotation thumbwheel, ensuring the trocar shaft is inserted smoothly through the probe guide.

**NOTE:** Do not force the trocar shaft through the probe guide. Rotate the probe guide as necessary.
6. Prepare the percutaneous site in accordance with standard surgical technique prior to insertion of the probe. Incise the selected area adequately to accommodate the trocar shaft.

**NOTE:** Ensure that you incise the selected area before penetrating the breast with the probe.

**NOTE:** Ensure that the patient and the probe are in the correct location for tissue biopsy.

**PRECAUTION:** Avoid positioning the aperture too close to the patient's skin.

**PRECAUTION:** Take care to avoid inadvertently hitting a blood vessel or vein.
7. Before entering the percutaneous site, the device should be "Engaged" or ARMED: Press and hold the ARM button on the holster to retract the cutter and trocar shaft. Ensure the trocar shaft is supported by the probe guide after the holster is armed.
  - The **blue** LED above the ARM button on the holster flashes to confirm the holster is responding. All other **blue** LEDs turn off, indicating they are not available.
  - The cutter retracts, then the trocar shaft retracts to the engaged position.
  - The aperture position indicator's **green** LEDs shows the aperture opening and closing as the probe completes the arming sequence.
  - At this time, the touchscreen interface on the control module displays a message confirming the system is ENGAGED.

**NOTE:** The sample aperture is in the CLOSED position after arming.

**NOTE:** The holster cannot operate the ARM/FIRE clinical functions in the variable aperture setting. The aperture must be set to the full (open) setting for the ARM/FIRE clinical function to be activated.

**WARNING:** Ensure that no hard material is forced into the aperture.

8. Once the device is ARMED (the “Engaged” message appears on the touchscreen interface), the probe may be inserted into the percutaneous site by following one of two methods: the “Pierce” method or the “Push-In” method.

**NOTE:** Take care to avoid the probe needle tip during this procedure. Failure to follow this instruction could lead to patient or operator injury.

**NOTE:** The ST holster only operates and allows tissue sampling with the probe in the post-fire (fully extended) position.

---

### ***“Pierce” Method***

- a. Introduce the probe through the incision and position the probe tip in the target area. Imaging guidance should be used as appropriate.
- b. To fire the probe, press and hold the mechanical safety release button; then press and hold the FIRE button on the active side of the holster at the same time. Imaging guidance should be used as appropriate to verify the probe is in the correct location for tissue biopsy.

**NOTE:** The sample aperture is in the OPEN position immediately after firing.

---

### ***“Push-In” Method***

- a. Before the probe has been inserted into the incision, first perform the DISARM function to slowly disengage the trocar shaft to its fully extended position.

**NOTE:** The sample aperture is in the OPEN position immediately after disarming.

- b. With the ST holster and probe in the post-fire position, ensure the ST probe cutter is CLOSED by pressing the OPEN/CLOSE button on the input device (green LEDs on the distal end of the holster indicate the cutter position).
- c. Introduce the probe through the incision.
- d. Position the probe tip in the desired position. Imaging guidance should be used as appropriate to verify the probe is in the correct location for tissue biopsy.

---

### ***Disarm***

- a. If the device is in the ARMED state but firing is not needed, or if using the push-in method as previously described:

Press and hold the ARM button on the holster until the blue LED above the ARM button begins to flash. The trocar shaft and holster firing fork slowly move to the post-fire (fully extended) position.

**NOTE:** Immediately after the trocar shaft has disengaged, the sample aperture is in the fully open position. If you wish to have the sample aperture closed, press the open/close button on the input device to move the cutter to the closed position.

**After the probe has been introduced into the percutaneous site using either of the methods listed above, the device is ready for tissue biopsy:**

9. Orient the sample aperture to the desired position by manually rotating the ST holster aperture rotation knobs or the ST probe aperture rotation thumbwheel; then press the BIOPSY button on the active input device (holster, remote footswitch, or remote keypad) to acquire a tissue sample.

**NOTE:** Pressing and releasing the BIOPSY button produces a single tissue sample, while pressing and holding the button produces continuous sampling when the user is holding down the button. If Continuous Sampling is desired, refer to [Other Instructions: Continuous Sampling](#).

#### *Biopsy Function Description*

- The biopsy cycle proceeds automatically.
- The specimen management system indexes to the next available chamber to receive the specimen.
- The inner cutter cannula retracts, lateral and axial vacuum are applied, tissue is drawn into the sample aperture, and the hollow inner cutter rotates and translates forward, cutting tissue.
- When the cutter reaches the distal end of the sample aperture, it stops moving.
- The probe then uses vacuum and a small amount of saline to transport the sample to the active specimen collection chamber.

**NOTE:** When the vacuum canister is full of fluid, the overflow protection system is activated and the vacuum stops operating. Replace the vacuum canister.

- The BIOPSY Indicator LED continuously flashes **blue**, and the motor is audible during the sampling and tissue collection process.
- At the end of the biopsy cycle, an audible tone sounds, the vacuum turns off, and the Biopsy Indicator LED illuminates solid **blue**.

**PRECAUTION:** The system must be primed with saline before use. Ensure that saline is used for the procedure. The absence of saline may cause a decrease in tissue transport to the chamber.

- A biopsy counter on the touchscreen interface keeps track of attempted samples. It appears as a number in the center of the SMS graphic, representing the number of attempted samples. (See [Chapter 8: Software Description](#).)

**PRECAUTION:** Collect no more than one sample in each tissue collection chamber.

- The biopsy cycle can be interrupted to avoid unnecessary injury or visualize the location of the sample aperture via imaging. (Refer to [Other Instructions: Sample Interrupt](#).)
- Do not remove the specimen collection chambers during tissue acquisition.

**PRECAUTION:** Keep hands clear of the device during the biopsy cycle, unless using continuous sampling.

**NOTE:** Only the ST holster operates and allows tissue sampling with the probe in the post-fire position.

**NOTE:** Refer to [Chapter 8: Software Description](#) for more information about the clinical function buttons and the touchscreen interface.

10. When the biopsy cycle is complete, as defined above, rotate the aperture rotation thumbwheel on the probe or aperture rotation knobs on the holster to the desired position for the next sample acquisition.
11. Repeat steps 9-10 as necessary to obtain additional tissue specimens.

**NOTE:** One Specimen Management System is designed to take up to 12 individual samples. If more than 12 samples are desired, replace the SMS with a new one and reset the chambers to continue. (See [Chapter 8: Software Description](#) for information on resetting the chambers.)

12. When the needed amount of tissue has been acquired, clear the sample aperture of any remaining tissue or fluids as described in [Other Instructions: Clearing a Clogged Probe](#).

**NOTE:** Tissue samples can be visually inspected through the sample management system.

13. When the needed amount of tissue has been acquired, tissue specimens can be removed from the specimen management system using one of two methods:

*a. Entire Cup Assembly (Sample Management System) Removal*

- Grasp the outer cup housing and rotate counterclockwise to remove the entire cup assembly from the probe. There are two groups of six chambers each in the cup, identified by radiopaque numbers 1-12.
- The specimen collection chambers can then be removed from the fluid management manifold, one group of six at a time, by grasping the pull tab to slide the chambers and tissue out of the manifold (1).

**NOTE:** Ensure the open area of the tissue chambers is facing up when removing them from the fluid management manifold.

**OR**

*b. Group of Chambers Removal*

- With the specimen management system still attached to the probe, one group of chambers can be removed at a time by grasping the pull tab to slide the chambers and tissue out of the manifold (1).

**NOTE:** Ensure the open area of the tissue chambers is facing up when removing from the fluid management manifold.

Once removed, each group of chambers can be flattened for further inspection or imaging (e.g., radiograph) by pressing in the middle of the group, above the pull tab (2).

**NOTE:** Do not place tissue chambers back into the specimen management system.

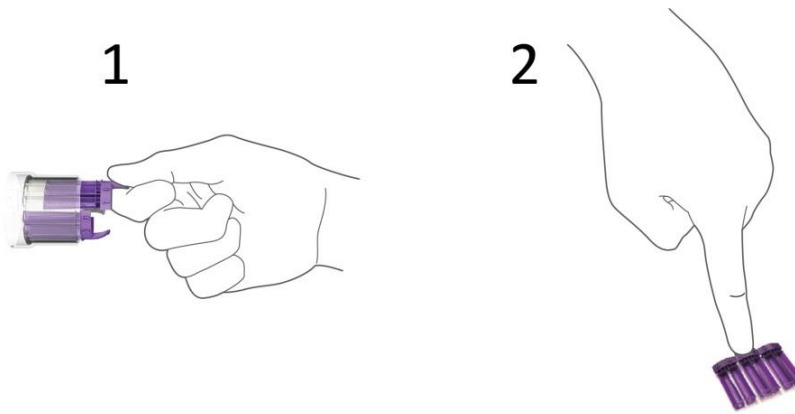

14. Perform post biopsy imaging of the patient and specimens as necessary.
15. Place a biopsy site identifier, if desired, by pressing the OPEN/CLOSE button on the input device to Open the aperture.  
**NOTE:** Do not activate the probe cutter or other clinical functions while a marker is inserted in the probe. If a marker was inserted in the probe without having the cutter opened, please remove the marker, open the cutter and then re-insert the marker. Take care to completely remove the marker from the probe before activating any of the holster's clinical functions.
16. Before removing the probe from the percutaneous site, ensure the sample aperture is closed off either by a biopsy site identifier applicator or a fully advanced cutter. Press the OPEN/CLOSE button on the input device to Close the aperture, as needed.
17. Remove the probe from the biopsy site by pulling the holster and probe back together as a unit.  
**NOTE:** Take care to avoid accidentally pressing the holster buttons. Do not unintentionally actuate cutter motion while the probe is in the patient. Failure to follow this instruction could lead to patient or operator injury.
18. The control module can be placed into standby at this time. (Refer to [Chapter 8: Software Description](#).)

---

## Other Instructions

### **Continuous Sampling**

When acquiring multiple tissue samples, the user may wish to use continuous sampling.

- a. Perform the **Steps for Tissue Sampling** through **Step 8**. At this point, the device is fully prepared for tissue biopsy.
- b. Press and hold the BIOPSY button on the active input device for as long as sampling is desired or until all specimen collection chambers are used. Each tissue sample is deposited into a dedicated specimen collection chamber.
  - i. During continuous sampling, the specimen management system automatically indexes to the next available chamber, and the system then proceeds to acquire the next specimen. Each tissue sample is deposited into a dedicated specimen collection chamber.

- ii. During sampling, when the cutter reaches the distal end of the sample aperture, it stops moving momentarily and a tone sounds, indicating the biopsy cycle is complete. The **green** LEDs on the holster interface illuminate to indicate the position of the cutter.
  - iii. Rotate the aperture rotation thumbwheel on the probe or aperture rotation knobs on the holster to orient the sample aperture for the next sample acquisition.
- c. Continue the biopsy procedure at Step 12 when ready to remove the specimen collection chambers from the device.

### **Sample Interrupt**

The biopsy cycle may be interrupted to avoid unnecessary injury.

- a. To interrupt the biopsy cycle, push any button other than biopsy (or the arm/fire buttons for ST) when the cutter is retracting from position 1 to 3 or when the cutter is advancing from 3 to 2. When the biopsy cycle is interrupted, the cutter retracts to position 3 (Open).

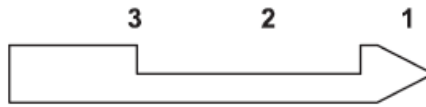

- b. The BIOPSY Indicator LED flashes **blue**.
- c. To complete the interrupted biopsy cycle, push the BIOPSY button again.

### **Fluid Delivery**

- a. Ensure the sample aperture is in the OPEN position prior to delivering fluid.

**NOTE:** Ensure that the collection chamber is attached to probe before saline or fluid delivery.

**NOTE:** The sample collection chamber must be aligned with the sample tube during saline or fluids delivery.

- b. Attach a standard threaded syringe, with the fluid to be delivered, to the injection port.
- c. Rotate the stopcock so the OFF indicator is pointing toward the tubing leading to the control module.
- d. Slowly inject fluid until it appears in the probe's tubing line on the other side of the probe, near where the pinch clip is.

**NOTE:** The fluid space of the axial vacuum line and inner lumen of the probe is approximately 9 cc for MST0809, 9 cc for MST0812, 10 cc for MST0815, 8 cc for MST1009, 8 cc for MST1012, and 8 cc for MST1015.

- e. Move the clamp (pinch clip) on the tubing line as close to the probe as possible and close it to pinch the line.
- f. Inject the necessary volume of fluids.
- g. Release the clamp once fluids are delivered to the biopsy site.
- h. Remove the syringe.



- i. Rotate the stopcock so the OFF indicator is pointing toward the injection port.

**PRECAUTION:** Failure to have the stopcock in the OFF position may produce a partial tissue sample or tissue sample of poor quality.

- j. Press the VAC button for up to 15 seconds to clear fluids from the probe.
- k. Continue the biopsy procedure, if desired.

### **Clearing a Clogged Probe**

**WARNING:** The pressure differential created in the canister during the procedure can cause blood discharge.

**NOTE:** If tissue, blood, or any other fluid clogs or fills the probe during the procedure, attempt to clear the probe by pressing and immediately releasing the VAC button on the active input device (holster, remote footswitch, or remote keypad) to initiate cutter movement and a vacuum pulse.

**NOTE:** The specimen management system needs to be attached to the probe for this function to be performed properly.

**NOTE:** Press and hold the VAC button to activate on-demand VACUUM for the duration of the button press (up to 15 seconds). Quickly pressing and releasing the VAC button commands the system to clear the probe.

Continue the biopsy procedure, if desired.

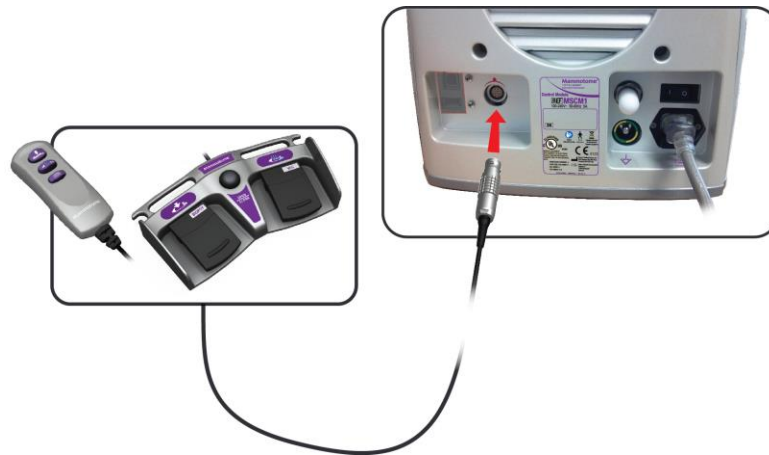

---

### **Disassembling the MammoTome revolve Dual Vacuum-Assisted Biopsy System**

When the tissue sampling procedure is complete, the user must discard the disposable system components.

#### **Disconnecting the ST Probe and Vacuum Tube Set**

- a. Using standard medical technique, remove the probe guide from the probe guide holder. Discard the probe guide in the appropriate container after use.
- b. Disconnect the saline spike on the vacuum tube set from the saline bag.

**WARNING:** Discard the saline bag using standard medical technique.

**NOTE:** Take care to ensure that no saline is spilled. Spills can damage the control module and/or the keypad storage receptacle.

- c. Disconnect the vacuum tube set line from the vacuum canister.

**NOTE:** Ensure the system is in standby before removing the vacuum tube set lines from the vacuum canister. Do **not** disconnect tubing while system is at the Ready screen.

- d. Disconnect the valve cartridge from the front of the control module.

- e. Optional: Connect the probe's two lateral vacuum tube set lines to each other and pinch the pinch valve, if desired, for disposal.

**PRECAUTION:** Do not remove the vacuum tubing from the vacuum canister if vacuum is being used.

- f. To remove the probe from the holster, press the locking button to the unlocked position.

**NOTE:** Do not reinstall the probe's protective sleeve. Doing so may cause injury to the user.

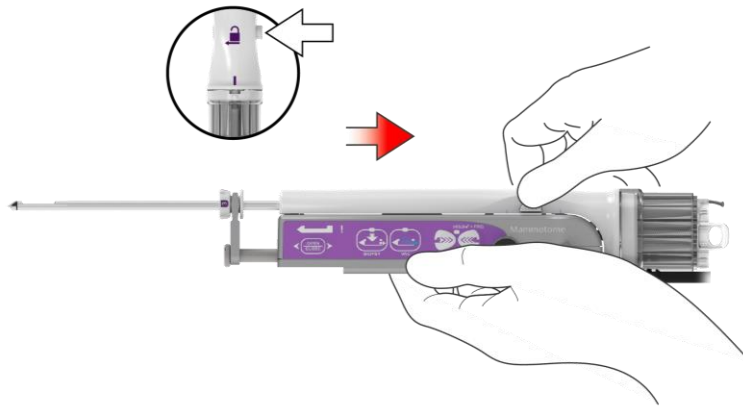

- g. While maintaining the button in the unlocked position, slide the probe back and lift up.

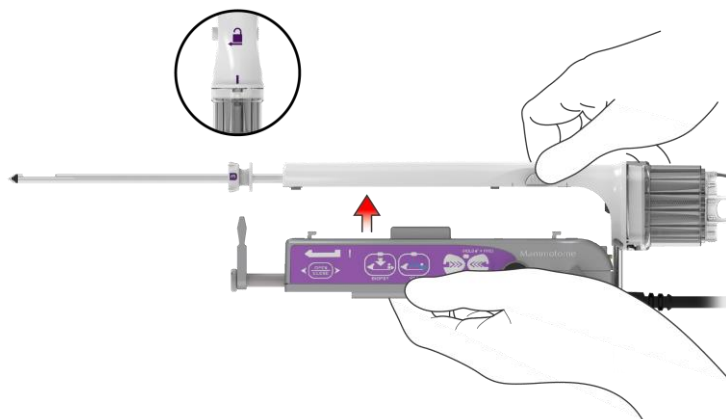

The probe disconnects from the holster.

- h. Discard the probe and vacuum tubing in the appropriate container(s) after use.

- i. If a new probe is used to continue sampling, follow Steps 6-9 in [Chapter 3: Initial Installation and Getting Started, Setup](#) to load a new probe.

### ***Disconnecting Input Devices***

- a. Remove the power connector for the remote footswitch or remote keypad from the control module's remote device connection port.

**NOTE:** Input devices can be disconnected from the control module at any time.

- b. Clean and/or disinfect the input device for later use as described in [Chapter 7: Cleaning and Disinfection](#).

### ***Disconnecting the Vacuum Canister***

- a. Disconnect the control module's flexible vacuum source tube from the center port of the lid.
- b. Close all ports at the top of the vacuum canister.
- c. Discard the vacuum canister in the appropriate container after use.

---

## **Shutting down the Mammotome revolve Dual Vacuum-Assisted Biopsy System**

1. To shut down the system, select the **green** POWER button on the front of the control module. A prompt on the screen asks the user to confirm the intended shutdown.
2. Touch YES to proceed to shut down.
  - o When YES is selected, the **green** POWER button on the front of the control module turns **amber**, indicating the system has shut down.
  - o Touch NO to return to the previous screen.
3. Turn the control module off at the back of the system (On/Off power switch).
4. Unplug the power cord from the grounded wall outlet.
5. Before disconnecting the holster's electrical cable from the control module, ensure the probe has been removed from the holster.
6. Disconnect the holster electrical cable from the control module.
7. Clean and disinfect the holster for later use as described in [Chapter 7: Cleaning and Disinfection](#).

**NOTE:** The Mammotome revolve Dual Vacuum-Assisted Biopsy System should be shut down once per day.

## Chapter 5 ULTRASOUND (U/S) INSTRUCTIONS FOR USE

---

### Overview

---

This chapter provides a step-by-step description for collecting tissue samples using the Mammotome revolve Dual Vacuum-Assisted Biopsy System for an Ultrasound (U/S) Guided Procedure.

### Mammotome revolve U/S Probe and U/S Holster

---

#### Summary Description

The Mammotome revolve U/S Probe and U/S Holster are used together to perform an ultrasound-guided breast biopsy procedure.

- The holster is a non-sterile, reusable instrument with one electrical cable for transmitting information to the control module. The holster communicates with the control module and U/S probe to drive the basic functionality for the procedure. Buttons on the holster control the functions of the Mammotome revolve Dual Vacuum-Assisted Biopsy System.
- The U/S Probe (with its integrated components) is a sterile, single-patient-use device that may be used with imaging guidance to excise a tissue sample for diagnosis. The probe is designed to be loaded onto the U/S holster. The probe consists of an outer trocar shaft and an inner cutter in a distal sample aperture. The sample aperture can be manually rotated by using the wrist to rotate the probe/holster assembly to the desired orientation. The probe comes packaged with an attached vacuum tube set to connect the probe to a vacuum source. The tube set has three points of attachment: 1) the control module vacuum connection slot, 2) the vacuum canister port, and 3) a saline bag. For further convenience, the probe includes a Specimen Management System consisting of 12 proximal specimen collection chambers. Each collection chamber is designed to capture and hold excised tissue. The specimen collection chambers are designed to be removed from the fluid management manifold in two separate trays (of six chambers each). If desired, the tissue can remain in the chambers to be directly imaged in the post-biopsy specimen radiograph.

**NOTE:** U/S Probe and Holster Illustrations and Nomenclature are described in [Chapter 2: System Description](#).

**Figure 21. U/S Holster Illustrated Nomenclature**

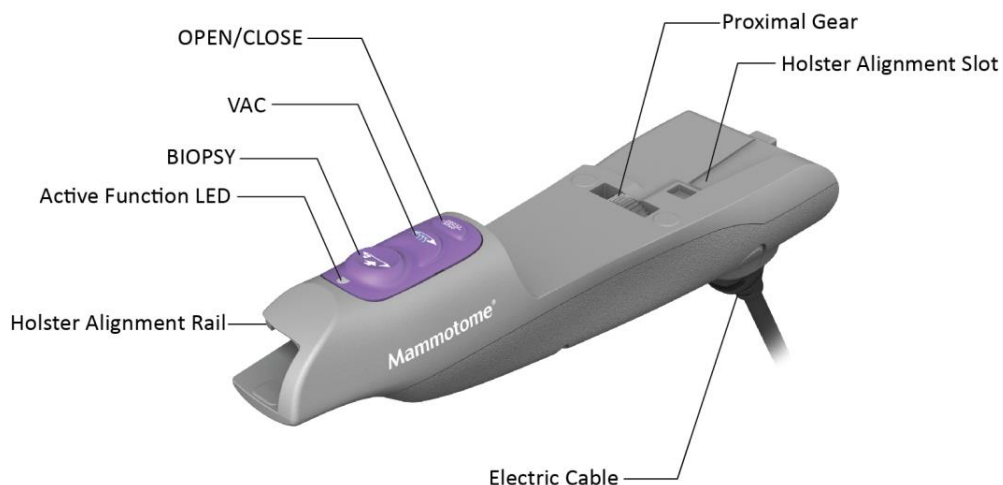

- **OPEN/CLOSE** button. Opens and closes the cutter location in the aperture.
- **VACUUM (VAC)** button. Activates vacuum aspiration and probe clearing.
  - Press and hold to activate vacuum aspiration for the duration of the press. The cutter retracts, and vacuum is applied for up to 15 seconds.
  - Press and immediately release to activate a short vacuum and saline pulse. If a specimen is not transported into its chamber, use this function to bring the clogged tissue or fluid into that chamber, rather than indexing to the next sequential chamber.
- **BIOPSY** button. Activates the cutter for tissue sampling.
  - Press and release for single specimen acquisition.
  - Press and hold for continuous sampling.

**NOTE:** When the BIOPSY button is depressed, the specimen management system first automatically indexes to the next available chamber to receive the attempted specimen.

**NOTE:** The sample aperture can be manually rotated by using the wrist to rotate the probe/holster assembly to the desired orientation.

**Figure 22. U/S HOLSTER LED Functions**



**NOTE:** If a remote input device is attached (e.g. remote footswitch, remote keypad), the blue LED on the U/S holster illuminates in the Active (flashing) state only.

### Preparation for Use

To prepare the Mammotome revolve Dual Vacuum-Assisted Biopsy System for tissue sampling, refer to [Chapter 3: Initial Installation and Getting Started](#).

### Steps for Tissue Sampling

1. Prepare the percutaneous site in accordance with standard surgical technique prior to insertion of the probe. Incise the selected area adequately to accommodate the trocar shaft.

**NOTE:** Ensure that you incise the selected area before penetrating the breast with the probe.

**NOTE:** Ensure that the patient and the probe are in the correct location for tissue biopsy.

**PRECAUTION:** Avoid positioning the aperture too close to the patient's skin.

**PRECAUTION:** Take care to avoid inadvertently hitting a blood vessel or vein.

2. Remove and discard the protective sleeve from the probe tip.

**WARNING:** Take care to avoid scraping of the needle tip against the protective sleeve and injury while removing the protective sleeve.

3. Introduce the probe into the percutaneous site through the skin incision.

4. With the system in the READY state, orient the sample aperture to the desired position; then press the BIOPSY button on the active input device (holster, remote footswitch, or remote keypad) to acquire a tissue sample.

**NOTE:** Pressing and releasing the BIOPSY button produces a single tissue sample, while pressing and holding the button produces continuous sampling if the user is holding down the BIOPSY button. If continuous sampling is desired, refer to [Other Instructions, Continuous Sampling](#).

#### *Biopsy Function Description*

- The biopsy cycle proceeds automatically.
- The specimen management system automatically indexes to the next available chamber to receive the specimen.
- The inner cutter cannula of the probe is retracted, lateral and axial vacuum are applied, tissue is drawn into the sample aperture and the hollow inner cutter rotates and translates forward, cutting tissue.
- When the cutter reaches the distal end of the sample aperture, it stops moving and uses vacuum and a small amount of saline to transport the sample to the active specimen collection chamber.

**NOTE:** When the vacuum canister is full of fluid, the overflow protection system is activated and the vacuum stops operating. Replace the vacuum canister.

- The BIOPSY Indicator LED continuously flashes **blue**, and the motor is audible during the sampling and tissue collection process.
- At the end of the biopsy cycle, a tone sounds, the vacuum turns off, and the Biopsy Indicator LED illuminates solid **blue**.

**PRECAUTION:** The system must be primed with saline before use. Ensure that saline is used for the procedure. The absence of saline may cause a decrease in tissue transport to the chamber.

- A biopsy counter on the touchscreen interface keeps track of attempted samples. A number in the center of the SMS graphic represents the number of attempted samples. See [Chapter 8: Software Description](#).

- The biopsy cycle can be interrupted to avoid unnecessary injury or visualize the location of the sample aperture via imaging, if desired. (Refer to [Other Instructions: Sample Interrupt.](#))
- Do not remove the specimen collection chambers during tissue acquisition.

**NOTE:** Do not move the probe during the biopsy cycle, as defined above.

**NOTE:** Refer to [Chapter 8: Software Description](#) for more information about operation of the clinical function buttons and the control module's touchscreen interface.

5. When the biopsy cycle is complete, as defined above, rotate the aperture to the desired position for the next sample acquisition.
6. Repeat Steps 4-5 as necessary to obtain additional tissue specimens.

**NOTE:** One Specimen Management System is designed to take up to 12 individual samples. If more than 12 samples are desired, replace the SMS with a new one and reset chambers to continue. See [Chapter 8: Software Description](#) for instructions on resetting chambers.

7. When the needed amount of tissue has been acquired, clear the sample aperture of any remaining tissue or fluids as described in [Other Instructions: Clearing a Clogged Probe.](#)

**NOTE:** Tissue samples can be visually inspected through the sample management system.

8. When the needed amount of tissue has been acquired, tissue specimens can be removed from the specimen management system using one of two methods:

*a. Entire Cup Assembly (Sample Management System) Removal*

- Grasp the outer cup housing and rotate counterclockwise to remove the entire cup assembly from the probe. There are two groups of six chambers each in the cup, identified by radiopaque numbers 1-12.
- The specimen collection chambers can be removed from the fluid management manifold, one group of six at a time, by grasping the pull tab to slide the chambers and tissue out of the manifold (1).

**PRECAUTION:** Ensure that no more than one (1) sample is collected in each collection chamber.

**NOTE:** Ensure the open area of the tissue chambers is facing up when removing them from the fluid management manifold.

**OR**

*b. Group of Chambers Removal*

- With the specimen management system remaining on the probe, one group of chambers can be removed at a time by grasping the pull tab and sliding the chambers with tissue out of the manifold (1).

**NOTE:** Ensure the open area of the tissue chambers is facing up when removing them from the fluid management manifold.

Once removed, each group of chambers can be flattened for further inspection or imaging (e.g., radiograph) by pressing in the middle of the group with the open area of the chambers facing up, above the pull tab (2).

**NOTE:** Do not replace the tissue chambers in the specimen management system.

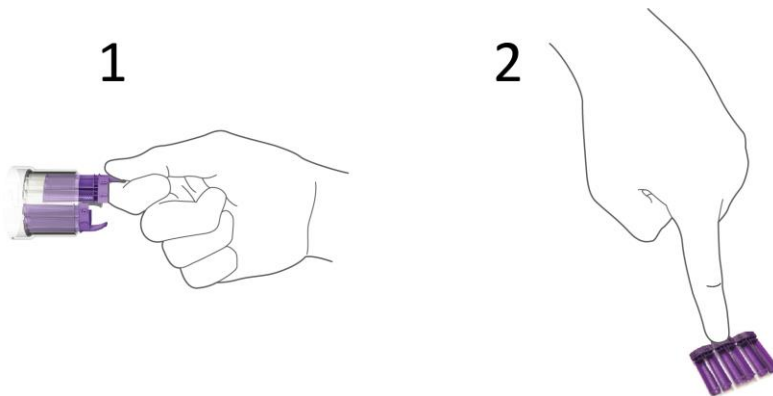

9. Perform post-biopsy imaging of the patient and specimens as necessary.
10. Place a biopsy site identifier if desired, by pressing the OPEN/CLOSE button on the input device to Open the aperture.  
**NOTE:** Do not activate the probe cutter or other clinical functions while a marker is inserted in the probe. If a marker was inserted in the probe without having the cutter opened, please remove the marker, open the cutter and then re-insert the marker. Take care to completely remove the marker from the probe before activating any of the holster's clinical functions.
11. Before removing the probe from the percutaneous site, ensure the sample aperture is closed off, either by a biopsy site identifier applicator or a fully closed cutter. Press the OPEN/CLOSE button on the input device to Close the aperture, as needed.
12. Remove the probe from the biopsy site by pulling the holster and probe back together as a unit.  
**NOTE:** Take care to avoid pressing holster buttons during removal. Do not unintentionally actuate cutter motion while the probe is in the patient. Failure to follow this instruction could lead to patient or operator injury.
13. The control module can be placed into standby at this time. (Refer to [Chapter 8: Software Description](#).)

---

## Other Instructions

### ***Continuous Sampling***

When acquiring multiple tissue samples, the user may wish to employ continuous sampling.

- a. Perform the Steps for Tissue Sampling through Step 3. At this point, the device is fully prepared for tissue biopsy.
- b. Press and hold the BIOPSY button on the active input device for as long as sampling is needed, or until all specimen collection chambers are used. Each tissue sample is deposited into a dedicated specimen collection chamber.
  - i. During continuous sampling, the specimen management system automatically indexes to the next available chamber, and the system then proceeds to acquire the next specimen. Each tissue sample is deposited into a dedicated specimen collection chamber.
  - ii. During sampling, when the cutter reaches the distal end of the sample aperture, it stops moving momentarily and a tone sounds, indicating the biopsy cycle is complete.



- iii. Rotate the probe/holster assembly to orient the sample aperture for the next sample acquisition.
- c. Continue the biopsy procedure at Step 7, removal of the specimen collection chambers from the device.

### **Sample Interrupt**

The biopsy cycle may be interrupted to avoid unnecessary injury.

- a. To interrupt the biopsy cycle, push any button other than BIOPSY when the cutter is retracting from position 1 to 3 or when the cutter is advancing from 3 to 2. When the biopsy cycle is interrupted, the cutter retracts to position 3 (Open).

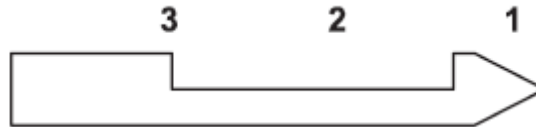

- b. The BIOPSY Indicator LED flashes blue.
- c. To complete the biopsy cycle, push the BIOPSY button again.

### **Delivering Fluid to Biopsy Site**

- a. Ensure the sample aperture is in the OPEN position prior to deliver fluid.
  - NOTE:** Ensure that the collection chamber is attached to probe before saline or fluid delivery.
  - NOTE:** The sample collection chamber must be aligned with the sample tube during saline or fluids delivery.
- b. Attach a standard threaded syringe, with the fluid to be delivered, to the injection port.
- c. Rotate the stopcock so the OFF indicator is pointing toward the tubing leading to the control module.
- d. Slowly inject fluid until it appears in the probe's tubing line on the other side of the probe, near where the pinch clip is.
  - NOTE:** The fluid space of the axial vacuum line and inner lumen of the U/S probe is approximately 9 cc for MHUS08 and 8 cc for MHUS10.
- e. Move the clamp (pinch clip) on the tubing line as close to the probe as possible and close it to pinch the line.
- f. Inject the needed volume of fluids.
- g. Release the clamp once the fluids are delivered to the biopsy site.
- h. Remove the syringe.
- i. Rotate the stopcock so the OFF indicator is pointing toward the injection port.
  - PRECAUTION:** Failure to have the stopcock in the OFF position may produce a partial tissue sample or tissue sample of poor quality.
- j. Press the VAC button for up to 15 seconds to clear fluids from the probe.

- k. Continue the biopsy procedure, if desired.

### **Clearing a Clogged Probe**

**WARNING:** The pressure differential created in the canister during the procedure can cause blood discharge.

**NOTE:** If tissue, blood, or any other fluid clogs or fills the probe during the procedure, attempt to clear the probe by pressing and immediately releasing the VAC button on the active input device (holster, remote footswitch, or remote keypad) to initiate cutter movement and a vacuum pulse.

**NOTE:** The specimen management system needs to be attached to the probe for this function to be performed properly.

**NOTE:** Press and hold the VAC button to activate on-demand VACUUM for the duration of the button press (up to 15 seconds). Quickly pressing and releasing the VAC button commands the system to clear the probe.

Continue the biopsy procedure, if desired.

---

## **Disassembling the Mammotome revolve Biopsy System**

When the tissue sampling procedure is complete, the user must discard the disposable system components.

### **Disconnecting the U/S Probe and Vacuum Tube Set**

- a. Disconnect the saline spike from the saline bag. Discard the saline bag using standard medical technique.

- b. Disconnect the vacuum tube set lines from the vacuum canister.

**NOTE:** Ensure the system is in standby before removing the vacuum tube set lines from the vacuum canister. Do **not** disconnect tubing while system is at the Ready screen.

- c. Disconnect the valve cartridge from the front of the control module.

- d. Optional: Connect the probe's two lateral vacuum tube set lines to each other and pinch the pinch valve, if desired, for disposal.

**NOTE:** Do not remove vacuum tubing from the vacuum canister if vacuum is being used.

- e. To remove the probe from the holster, press in on the locking tab on the side of the probe body. Pull the probe backward about one inch and then to the right to disconnect it from the holster.

**NOTE:** **Do not** reinstall the probe's protective sleeve. Doing so may cause injury to the user.

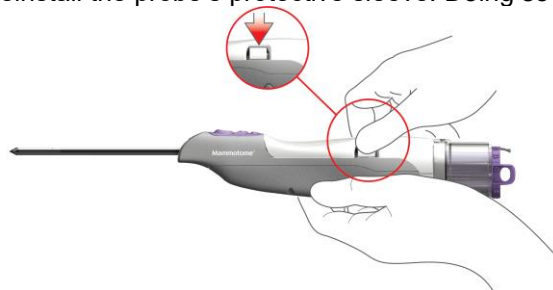

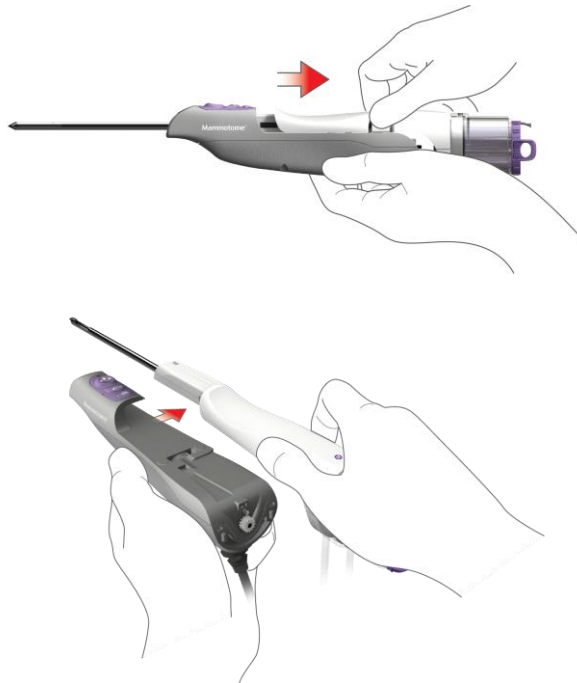

- f. Discard the probe and vacuum tubing in the appropriate container(s) after use.
- g. If additional sampling is planned, follow Steps 6-9 in [Chapter 3: Initial Installation and Getting Started, Setup](#) to install a new probe on the holster.

---

### Disconnecting Input Devices

- a. Disconnect the remote footswitch or remote keypad from the control module's remote device connection port.

**NOTE:** Input devices may be disconnected from the control module at any time.

- b. Clean and/or disinfect the input device for later use as described in [Chapter 7: Cleaning and Disinfection](#).

### *Disconnecting the Vacuum Canister*

- a. Disconnect the control module's flexible vacuum source tube from the center port of the lid.
- b. Close all the ports at the top of the vacuum canister.
- c. Discard the vacuum canister in the appropriate container after use.

---

### Shutting Down the Mammotome revolve Dual Vacuum-Assisted Biopsy System

1. To shut down the system, press the green power button on the front of the control module. A prompt appears on the screen, asking you to confirm the intended shutdown.
2. Touch YES to proceed to shut down.

- If YES is selected, the **green** POWER button on the front of the control module turns an **amber** color, indicating the system has shut down.
  - Touch NO to return to the previous screen.
3. Turn the control module off at the back of the system (On/Off power switch).
  4. Unplug the power cord from the grounded wall outlet.
  5. Before disconnecting the holster's electrical cable from the control module, ensure the probe has been removed from the holster.
  6. Disconnect the holster electrical cable from the control module.
  7. Clean and disinfect the holster for later use as described in [Chapter 7: Cleaning and Disinfection](#).

**NOTE:** The Mammotome revolve Dual Vacuum-Assisted Biopsy System should be shut down once per day.

## Chapter 6 EX INSTRUCTIONS FOR USE

---

### Overview

---

This chapter provides a step-by-step description for collecting tissue samples using the Mammotome revolve Dual Vacuum-Assisted Biopsy System for an EX Ultrasound Guided Procedure.

### Mammotome revolve EX Probe and EX Holster

---

#### Summary Description

The Mammotome revolve EX Probe and EX Holster are used together to perform an ultrasound-guided breast biopsy procedure.

- The EX holster is a non-sterile, reusable instrument with one electrical cable for transmitting information to the control module. The holster communicates with the control module and EX probe to drive the basic functionality for the procedure. Buttons on the holster control the functions of the Mammotome revolve Dual Vacuum-Assisted Biopsy System.
- The EX Probe (with its integrated components) is a sterile, single-patient-use device that may be used with imaging guidance to excise (a) tissue sample(s). The probe is designed to be loaded onto the EX holster. The probe consists of an outer trocar shaft and an inner cutter in a distal sample aperture. The sample aperture can be manually rotated by using the wrist to rotate the probe/holster assembly to the desired orientation. The probe comes packaged with an attached vacuum tube set to connect the probe to a vacuum source. The tube set has three points of attachment: 1) the control module vacuum connection slot, 2) the vacuum canister port, and 3) a saline bag. For further convenience, the probe includes a Specimen Management System consisting of four (4) proximal specimen collection chambers. Three (3) collection chambers are designed to capture and hold the excised tissue of a 25 mm lesion (approximate). One (1) chamber is designed to hold a single piece of excised tissue for removal and examination. The specimen collection chambers are designed to be removed from the fluid management manifold.

**NOTE:** Only the Mammotome revolve probes with the letters “EX” in the product code should be used with the Mammotome revolve EX Holster.

**NOTE:** EX Probe, Sleeve, and Holster Illustrations and Nomenclature are described in [Chapter 2: System Description](#).

## Figure 23. EX HOLSTER LED Functions

**NOTE:** If a remote input device is attached (e.g. remote footswitch, remote keypad), the blue LED on the EX holster illuminates in the Active (flashing) state only.

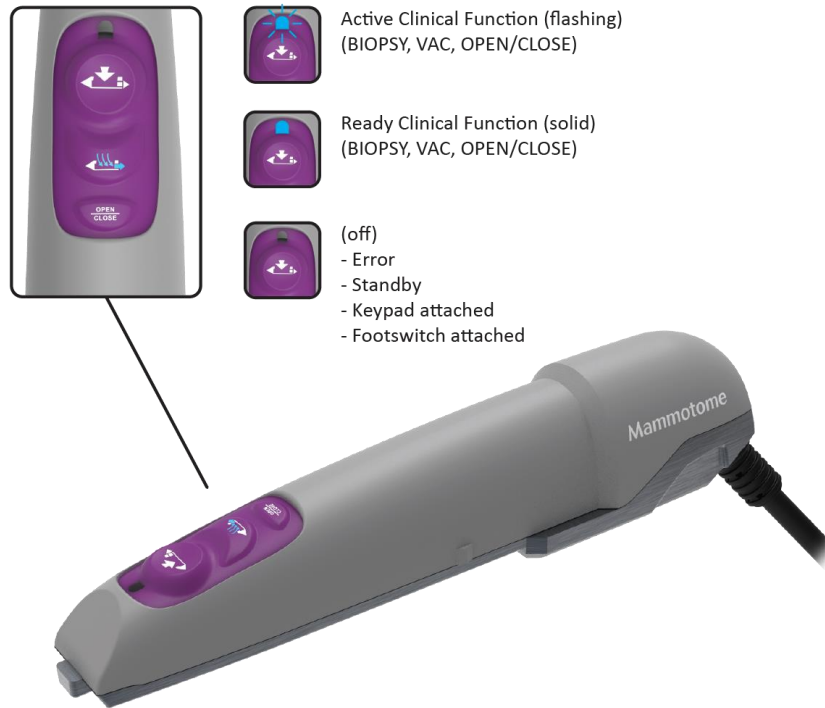

## Preparation for Use

To prepare the Mammotome revolve Dual Vacuum-Assisted Biopsy System for tissue sampling, refer to [Chapter 3: Initial Installation and Getting Started](#).

## Instructions for Use

### Steps for Tissue Sampling

1. Prepare the percutaneous site in accordance with standard surgical technique prior to insertion of the probe. Incise the selected area adequately to accommodate the trocar shaft.

**NOTE:** Ensure that you incise the selected area before penetrating the breast with the probe.

**NOTE:** Ensure that the patient and the probe are in the correct location for tissue biopsy.

**PRECAUTION:** Avoid positioning the aperture too close to the patient's skin.

**PRECAUTION:** Take care to avoid inadvertently hitting a blood vessel or vein.

2. Without lifting off the docking station, remove the tip protector (protective sleeve) from the probe tip by grasping the holster and probe assembly in the grip area and pulling the device out in line with the tip protector.

**WARNING:** Take care to avoid scrapping of the needle tip against the protective sleeve and injury while removing the protective sleeve.

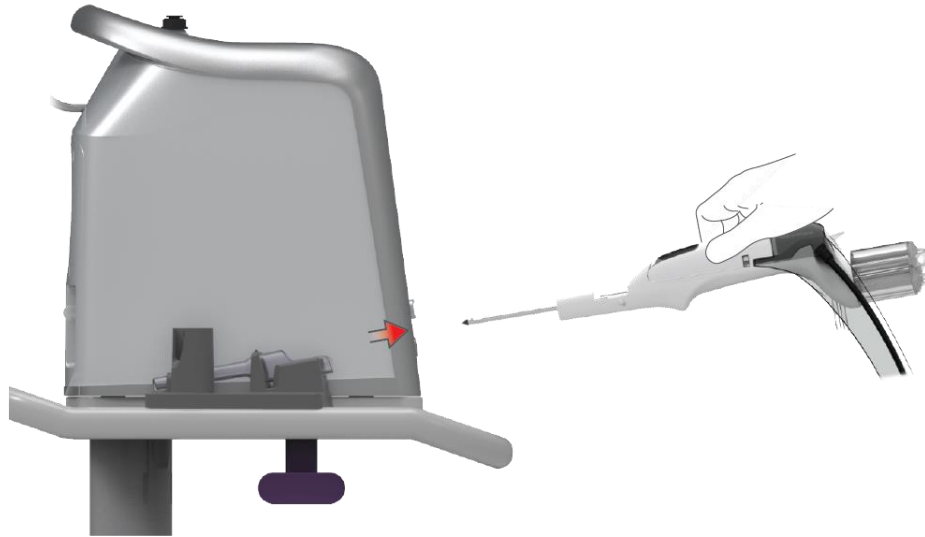

3. Introduce the probe into the percutaneous site through the skin incision.

**NOTE:** To introduce the probe from the percutaneous site, ensure the sample aperture is closed off, either by a biopsy site identifier applicator or a fully closed cutter.

**NOTE:** Ensure that sample management system chambers are attached to the MHEX08S probe [with or without sleeve] before beginning sample acquisition.

4. With the system in the READY state, orient the sample aperture to the desired position, then press the BIOPSY button on the active input device (holster, remote footswitch, or remote keypad) to acquire a tissue sample.

**NOTE:** Pressing and releasing the BIOPSY button produces a single tissue sample, while pressing and holding the button produces continuous sampling when the user is holding down the BIOPSY button. If continuous sampling is desired, refer to [Other Instructions, Continuous Sampling](#).

#### *Biopsy Function Description*

- The biopsy cycle proceeds automatically.
- As the inner cutter cannula of the probe is retracted, the previous sample moves from the viewing window to the aligned chamber in the sample management system.
- After the inner cutter cannula of the probe is retracted, lateral and axial vacuum are applied, tissue is drawn into the sample aperture, and the hollow inner cutter rotates and translates forward, cutting tissue.
- When the cutter reaches the distal end of the sample aperture, it stops moving and uses vacuum and a small amount of saline to transport the sample to the sample viewing window.

**NOTE:** When the vacuum canister is full of fluid, the overflow protection system is activated and the vacuum stops operating. Replace the vacuum canister.

- The BIOPSY Indicator LED continuously flashes **blue**, and the motor is audible during the sampling and tissue collection process.
- At the end of the biopsy cycle, a tone sounds, the vacuum turns off and the Biopsy Indicator LED illuminates solid **blue**.

**PRECAUTION:** The system must be primed with saline before use. Ensure that saline is used for the procedure. The absence of saline may cause a decrease in tissue transport to the chamber.

**NOTE:** Tissue samples can be visually inspected through the viewing window.

- A biopsy counter on the touchscreen interface keeps track of attempted samples. A number in the center of the SMS graphic represents the number of attempted samples. (See [Chapter 8: Software Description](#).)
- The biopsy cycle can be interrupted to avoid unnecessary injury or visualize the location of the sample aperture via imaging, if desired. (Refer to [Other Instructions: Sample Interrupt](#).)
- Do not remove the specimen collection chambers during tissue acquisition unless the sample management system is oriented so that a new chamber is set to receive the tissue specimen.

**NOTE:** Do not move the probe during the biopsy cycle, as defined above.

**NOTE:** Refer to [Chapter 8: Software Description](#) for more information about operation of the clinical function buttons and the control module's touchscreen interface.

5. When the biopsy cycle is complete, as defined above, rotate the aperture to the desired position for the next sample acquisition.
6. Repeat Steps 4-5 as necessary to obtain additional specimens.

**NOTE:** One Large Specimen Management System chamber is designed to take up to 25 individual samples. If more than 25 samples are needed or if a second lesion is to be obtained, manually rotate the SMS to a new collection chamber. Reset specimen count, as desired, before continuing. See [Chapter 8: Software Description](#) for instructions on resetting specimen count.

**NOTE:** One Single Specimen Management System chamber is designed to hold one individual sample. If more than a single sample is needed, manually rotate the SMS to a new or large collection chamber.

**NOTE:** Ensure that the collection chamber is not rotated to an already full chamber.

**NOTE:** The chambers can be reinserted if additional samples are necessary. Ensure the chamber is fully inserted into the sample management system before acquiring additional samples .

7. When the needed amount of tissue has been acquired, clear the sample aperture of any remaining tissue or fluids as described in [Other Instructions: Clearing a Clogged Probe, Tissue Viewing Window, or Moving Sample to Sample Collection Area](#).
8. With the specimen management system remaining on the probe, grasp the probe with one hand. With the other hand, slowly pull the tray in two motions:
  - i. Gently break the seal.
  - ii. Fully withdraw the tray.



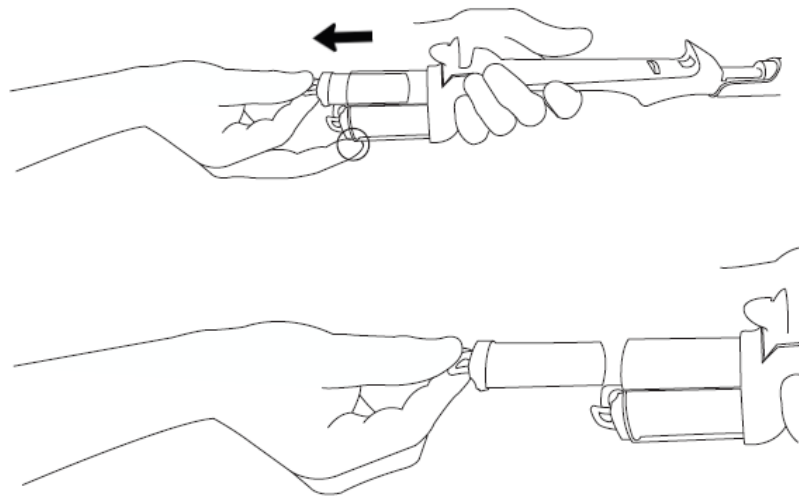

**PRECAUTION:** Remove the tray in a slow, controlled manner to prevent the possibility of spilling tissue and fluid.

**PRECAUTION:** Ensure the open area of the tray is facing up when removing it from the fluid management manifold.

9. Perform post-biopsy imaging of the patient and specimens as necessary.
10. Before removing the probe from the percutaneous site, ensure the sample aperture is closed. Press the OPEN/CLOSE button on the input device to Close the aperture, as needed.
11. Remove the probe from the biopsy site by pulling the holster and probe back together as a unit.

**NOTE:** Take care to avoid pressing holster buttons during removal. Do not unintentionally actuate cutter motion while the probe is in the patient. Failure to follow this instruction could lead to patient or operator injury.
12. The control module can be placed into Standby at this time. Refer to [Chapter 8: Software Description](#).

**NOTE:** If the last button pressed was BIOPSY, the aperture opens and transports the last tissue sample from the viewing window to the tissue sample chamber aligned.

---

## Other Instructions

### ***Continuous Sampling***

When acquiring multiple tissue samples, the user may wish to use continuous sampling.

- a. Perform the **Steps for Tissue Sampling** through **Step 3**. At this point, the device is fully prepared for tissue biopsy.
  - i. Press and hold the BIOPSY button on the active input device for continuous sampling. The device will stop sampling after 30 continuous tissue sample attempts; release the BIOPSY button and continuously press again to continue sampling, when the cutter reaches the distal end of the sample aperture, it stops moving momentarily and a tone sounds, indicating the biopsy cycle is complete.

- ii. Rotate the probe/holster assembly to orient the sample aperture for the next sample acquisition.

**NOTE:** Manual rotation of the specimen collection chambers is necessary for more than 25 tissue samples in a single large chamber.

- b. Continue the biopsy procedure at Step 8 removal of the specimen collection chambers from the device.

### **Sample Interrupt**

The biopsy cycle may be interrupted to avoid unnecessary injury.

- a. To interrupt the biopsy cycle, push any button other than BIOPSY when the cutter is retracting from position 1 to 3 or when the cutter is advancing from 3 to 2. When the biopsy cycle is interrupted, the cutter retracts to position 3 (Open).

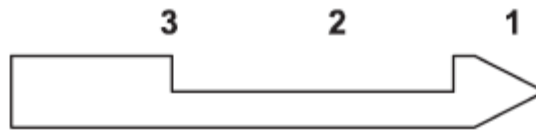

- b. The BIOPSY Indicator LED flashes blue.
- c. To complete the biopsy cycle, push the BIOPSY button again.

### **Delivering Fluid to Biopsy Site**

During the procedure, while the probe is in position, the stopcock on the axial vacuum line can be used to deliver fluids to the biopsy site.

- a. Ensure the sample aperture is in the OPEN position prior to deliver fluid.

**NOTE:** Ensure that the collection chamber is attached to probe before saline or fluid delivery.

**NOTE:** The sample collection chamber must be aligned with the sample tube during saline or fluids delivery.

- b. Attach a standard threaded syringe with the fluid to be delivered to the injection port.
- c. Rotate the stopcock so the OFF indicator is pointing toward the tubing leading to the control module.
- d. Slowly inject fluid until it appears in the probe's tubing line on the other side of the probe, near the pinch clip.

**NOTE:** The fluid space of the axial vacuum line and inner lumen of the EX probe is approximately 9 cc for MHEX08(S).

- e. Move the clamp (pinch clip) on the tubing line as close to the probe as possible and close it to pinch the line.
- f. Inject the required volume of fluids.
- g. Release the clamp after the fluids are delivered to the biopsy site.
- h. Remove the syringe.

- i. Rotate the stopcock so the OFF indicator is pointing toward the injection port.

**PRECAUTION:** Failure to have the stopcock in the OFF position may produce a partial tissue sample or tissue sample of poor quality.

- j. Press the VAC button for up to 15 seconds to clear fluids from the probe.
- k. Continue the biopsy procedure, if desired.

#### ***Clearing a Clogged Probe, Tissue Viewing Window, or Moving Sample to Sample Collection Area***

- a. If tissue is in the tissue viewing area and must be moved to the Sample Collection Area, attempt to move the tissue by pressing and releasing the VAC button, OPEN/CLOSE button, or BIOPSY button on the active input device (holster, remote footswitch, or remote keypad). Each begins with a cutter movement and vacuum pulse to move the tissue.

**PRECAUTION:** The specimen management system needs to be attached to the probe for this function to be performed properly.

**PRECAUTION:** Pressing and holding the VAC button activates on-demand vacuum for the duration of the button press (up to 15 seconds), while pressing and quickly releasing the VAC button commands the system to clear the probe.

- b. Continue the biopsy procedure, if needed.

#### ***Changing Input Devices***

To change the remote footswitch or remote keypad, grasp the connector and pull back to remove it from the remote device connection port. This can be done whether the control module is on or off.

**NOTE:** If the system is on, a chime sounds when the input device is connected or removed.

---

### **Disassembling the Mammotome revolve Biopsy System**

When the tissue sampling procedure is complete, the user must discard the disposable system components.

#### ***Disconnecting the EX Probe and Vacuum Tube Set***

**NOTE:** Place the holster/probe assembly on the holster/probe holder of the docking station by pushing the probe tip straight into the tip protector (protective sleeve) while holding the device in the grip area.

**NOTE:** Do not use two hands to install or remove the tip protector onto the probe. Using both hands increases the likelihood of probe puncture and contamination.

**WARNING:** Disconnect the saline spike from the saline bag. Discard the saline bag using standard medical techniques.

**NOTE:** Take care to ensure that no saline is spilled. Spills can damage the control module and/or the keypad storage receptacle.

- a. Disconnect the vacuum tube set lines from the vacuum canister.

**NOTE:** Ensure the system is in Standby before removing the vacuum tube set lines from the vacuum canister. **Do not** disconnect tubing while system is at the Ready screen.

- b. Disconnect the valve cartridge from the front of the control module.
- c. **Optional:** Connect the probe's two lateral vacuum tube set lines to each other and pinch the pinch valve, if desired, for disposal.

**NOTE:** Do not remove vacuum tubing from the vacuum canister if vacuum is being used (ON).

- d. To remove the probe from the holster, press down on the locking tab on the back of the probe body. Pull the holster upward about two inches and then backwards to disconnect it from the probe.

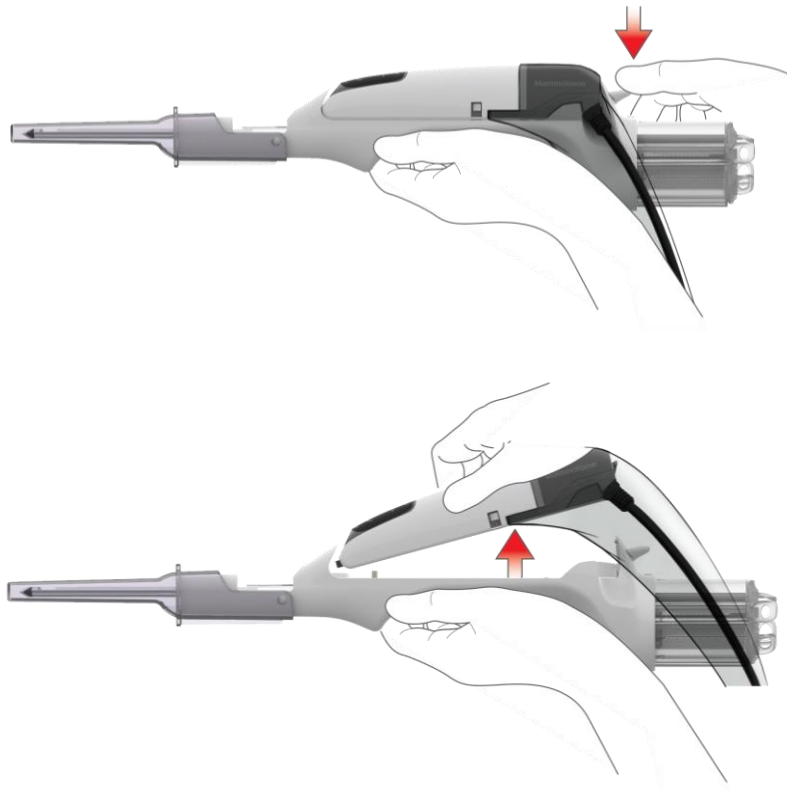

**NOTE:** If BIOPSY was the last button pressed before removal and the system has not been shut down or put into standby, the “Check Tissue” screen will be shown. (See [Chapter 9: Service and Troubleshooting](#) for further instruction.)

- e. When using the sleeve:
  - i., ii. Slide the sleeve up the cable, back over the holster.

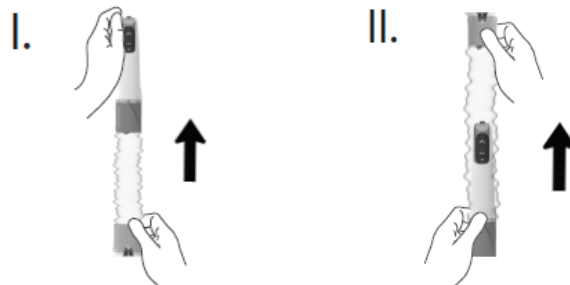

- iii. With two hands, pull the sleeve from the holster.

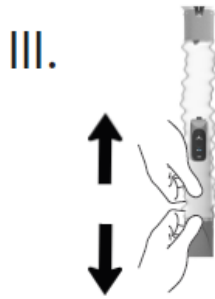

iv. Discard the removed sleeve.

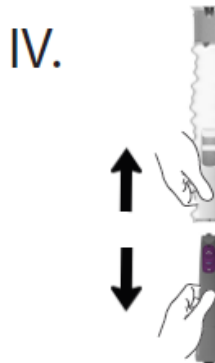

**NOTE:** **DO NOT** attempt to reinstall the probe's protective sleeve by hand. Doing so may cause injury to the user.

**PRECAUTION:** Discard the probe, sleeve (if used), and vacuum tubing in the appropriate container(s) after use.

- f. If additional sampling is planned, follow Steps 6-9 in [Chapter 3: Initial Installation and Getting Started, Setup](#) to install a new probe and sleeve onto the holster.

#### ***Disconnecting Input Devices***

- a. Disconnect the remote footswitch or remote keypad from the control module's remote device connection port.

**NOTE:** Input devices may be disconnected from the control module at any time.

- b. Clean and/or disinfect the input device for later use as described in [Chapter 7: Cleaning and Disinfection](#).

#### ***Disconnecting the Vacuum Canister***

- a. Disconnect the control module's flexible vacuum source tube from the center port of the lid.
- b. Close all ports at the top of the vacuum canister.
- c. Discard the vacuum canister in the appropriate container after use.

---

## Shutting Down the Mammotome revolve Dual Vacuum-Assisted Biopsy System

1. To shut down the system, press the **green** power button on the front of the control module. A prompt appears on the screen, asking you to confirm the intended shutdown.
2. Touch YES to proceed to shut down.
  - If YES is selected, the **green** POWER button on the front of the control module turns an **amber** color, indicating the system has shut down.
  - Touch NO to return to the previous screen.

**NOTE:** If the last button pressed was BIOPSY and the system hasn't been placed into Standby, the aperture will open and transport the last tissue sample from the viewing window to the tissue sample chamber aligned.

3. Turn the control module off at the back of the system (On/Off power switch).
4. Unplug the power cord from the grounded wall outlet.
5. Before disconnecting the holster's electrical cable from the control module, ensure the probe has been removed from the holster.
6. Disconnect the holster electrical cable from the control module.
7. Clean and disinfect the holster for later use, as described in [Chapter 7: Cleaning and Disinfection](#).

## Chapter 7 CLEANING AND DISINFECTION

---

**All information in this guide applies to ST, U/S, and EX modalities, unless otherwise noted.**

### Introduction

---

This chapter includes detailed cleaning and disinfection instructions for the Mammotome revolve Dual Vacuum-Assisted Biopsy System per ISO 17664.

Users in North America should also refer to appropriate sections of *AORN Standards & Recommended Practices* for additional guidance on cleaning and disinfection. All other localities should refer to appropriate guidelines.

The cleaning agents and disinfectants specified for use in these instructions have been validated for use with the Mammotome revolve Biopsy System. The use of cleaning agents or disinfectants other than those specified in these instructions should be assessed for equivalency before using. Technical data sheets are typically available through the cleaning/disinfection agent manufacturer's web pages to assist in this assessment. Any cleaning or disinfection process, including tools and solutions, may influence the wear of a device or equipment.

There are no limitations for time of storage of any disinfected device prior to use and no additional support systems are required.

**PRECAUTION:** Before cleaning or disinfecting the system, turn off the system and disconnect the power cord from the power source. No further disassembly required.

**NOTE:** After cleaning and disinfecting the system, refer to the "Preventative Maintenance" section for maintenance information. Inspect the devices for non-cosmetic damage prior to use, dispose or return device to the manufacturer if damage is found.

**WARNING:** Do not attempt to sterilize the holsters, control module, cart, remote keypad, or remote footswitch through autoclave, ethylene oxide, radiation, or plasma sterilization procedures; do not process the devices through an automated washer-disinfect or ultrasound bath; do not spray the devices with fluids or submerge in fluids; this may damage the instrument. If the devices are cleaned improperly, the warranties may be void. Do not transport the device in a container prior to cleaning.

### Cleaning Instructions for the Control Module, Cart, and Remote Footswitch

---

#### Cleaning the Control Module, Cart, and Remote Footswitch: Option 1

After each use, manually clean the control module, cart, and remote footswitch thoroughly utilizing a pH-neutral enzymatic detergent. Proceed with manual cleaning utilizing the following procedure:

1. Prepare a pH-neutral detergent or pH-neutral enzymatic detergent according to the manufacturer's directions.
2. Use a soft, clean cloth lightly moistened with the cleaning solution to manually clean all surfaces, including crevices.
3. To rinse, wipe thoroughly using a soft, clean cloth lightly moistened with lukewarm (27°C–44°C) tap water.
4. Dry with a clean, soft cloth. Do not expose the device to heat greater than 54°C.
5. Inspect the device for visible contamination. If contamination is present, repeat steps 1-5 until no visible contamination is present.

## Cleaning the Control Module, Cart, and Remote Footswitch: Option 2

Using Process Chemical Super Sani-Cloth (Manufacturer: PDI):

1. Use the specified wipe to wipe all external surfaces, including crevices to remove any debris.
2. Use the specified wipe to thoroughly wipe all external surfaces including cracks and crevices, ensuring that a wet surface is maintained for 2.5 minutes.

**Note:** Additional wipes may be used to maintain the 2.5 minute contact time.

3. Use additional wipe(s) to repeat steps 1-2, above.
4. Allow the Control Module, Cart, and Remote Footswitch to air dry.
5. Perform a visual check to ensure all visible contamination is removed from the surface. If contamination is present, repeat steps 1-3 until no visible contamination is present.

## Cleaning and Disinfection Instructions for the Holsters and Remote Keypad

---

### Cleaning the ST or U/S Holster: Option 1

Less than 45 minutes after each use, manually clean the holster thoroughly using a pH-neutral enzymatic detergent. Proceed with manual cleaning using the following procedure:

1. Prepare a pH-neutral detergent or pH-neutral enzymatic detergent according to the manufacturer's directions.
2. Use a soft, clean cloth lightly moistened with the cleaning solution to manually clean all surfaces (including crevices) that are exposed when the disposable probe is attached to the holster. **The gears on the holster should not be wiped with detergent.**
3. To rinse, wipe thoroughly using a soft, clean cloth lightly moistened with lukewarm (27°C – 44°C) tap water.

**Note:** To rinse the crevices, wipe thoroughly using a clean soft bristle, standard toothbrush moistened with lukewarm (27°C- 44°C) tap water.

4. Dry with a clean, soft cloth. Do not expose the device to heat greater than 54°C.
5. Inspect the device for visible contamination. If contamination is present, repeat steps 1-5 until no visible contamination is present.

### Cleaning the ST or U/S Holster: Option 2

Using Process Chemical Super Sani-Cloth (Manufacturer: PDI):

**Additional Cleaning Tool(s):** Soft Bristled Nylon Brush (brush head approximate dimensions: width 9 mm, length 40 mm, individual bristles 9 mm long)

1. Use the specified wipe to wipe all external surfaces including crevices.
2. Thoroughly scrub crevice areas with a clean, dry soft bristled nylon brush for a minimum of 1 minute 10 seconds.
3. Use the specified wipe to thoroughly wipe the device, including crevices, ensuring that a wet surface is maintained for 2.5 minutes.



**Note:** The gears and electronics on the underside of the Holster should not be wiped with the cleaner.

**Note:** Additional wipes may be used to maintain the 2.5 minute contact time.

4. Allow the holster to air dry.
5. Perform a visual check to ensure all visible contamination is removed from the surface. If contamination is present, repeat steps 1-4 until no visible contamination is present.

#### **Disinfecting the ST or U/S Holster: Option 1**

An intermediate-level disinfection process must follow the cleaning procedure. The following chemical disinfectants are approved for use with the holster:

- 50% Bleach (Sodium Hypochlorite) Solution (1 part bleach to 1 part purified or deionized water)

Disinfectants should be prepared and used according to the manufacturer's recommendations for use, concentration, and contact time. The use of other disinfectants, other than those specified in these instructions, should be assessed for equivalency before using. Technical data sheets are typically available through the disinfectant manufacturers' web pages to assist in this assessment. Any disinfection process, including tools and solutions, may influence the wear of a device or equipment.

1. Soak a clean cloth and a soft bristle toothbrush in the disinfectant solution. Squeeze the cloth thoroughly to remove all excess solution. Tap toothbrush to remove excess solution.
2. Thoroughly wipe down all surfaces of the holster that are visible when a probe is attached, ensuring that a slightly wet surface is maintained for five minutes. The gears of the holster should not be wiped with the disinfectant.
3. Thoroughly scrub crevice areas with the soft bristle, standard toothbrush, ensuring that a slightly wet surface is maintained for five minutes.
4. Sterile gauze or a clean, soft cloth moistened with purified water should be used to remove the disinfectant from the device. Repeat four additional times to thoroughly remove residue.
5. A clean, soft bristle standard toothbrush moistened with purified water should be used to remove the disinfectant from the crevices of the device. Repeat six additional times to thoroughly remove residue.
6. Wipe the holster with 70% Isopropyl Alcohol (IPA) applied to gauze. Ensure the gauze is inserted into the crevices of the device.
7. Allow the holster to air dry. Do not expose the device to heat greater than 54°C.

#### **Disinfecting the ST or U/S Holster: Option 2**

Using Process Chemical Super Sani-Cloth (Manufacturer: PDI):

1. Use the specified wipe to thoroughly wipe down all surfaces of the Holster that are exposed when probe is attached to the Holster ensuring that a slightly wet surface is maintained for 2 minutes. The gears and electronics on the underside of the Holster should not be wiped with disinfectant.

**Note:** Pay special attention to crevices.

**Note:** Additional wipes may be used to maintain the 2 minute contact time.

2. Allow the holster to air dry.

**NOTE:** In the applied decontamination process, ensure that detergent and disinfectant residuals are

sufficiently removed. Purified or deionized water should be used during final rinsing processes, where applicable. (Multiple rinses may be required.) Refer to the manufacturer's recommendations for the removal of disinfectant residue.

**NOTE:** Disinfected products should be stored in a dry clean environment, protected from contamination, direct sunlight, pests, and extreme temperature and humidity. Do not transport the device in a container prior to disinfection.

The Mammotome revolve ST and U/S holsters have an expected life of 500 reprocessing cycles.

### Cleaning the EX Holster

After each use, manually clean the EX holster thoroughly using one of the following wipes:

| Active Ingredients                                                                                                                                                                                                                        | Concentration                                                                       | Recommended Product                                                | Wet Contact Time |
|-------------------------------------------------------------------------------------------------------------------------------------------------------------------------------------------------------------------------------------------|-------------------------------------------------------------------------------------|--------------------------------------------------------------------|------------------|
| <ul style="list-style-type: none"> <li>Isopropanol</li> <li>Ethylene Glycol Monobutyl Ether (2-Butoxyethanol)</li> <li>Diisobutylphenoxyethoxyethyl dimethylbenzyl ammonium chloride</li> </ul>                                           | <ul style="list-style-type: none"> <li>17.2%</li> <li>1%</li> <li>0.28%</li> </ul>  | CaviWipes™ by Metrex® Research                                     | 3 minutes        |
| <ul style="list-style-type: none"> <li>Isopropyl Alcohol</li> <li>Alkyl (60% C14, 32% C16, 5% C12, 5% C18) dimethyl benzyl ammonium chlorides</li> <li>Alkyl (68% C12, 32% C14) dimethyl ethylbenzyl ammonium chloride (0.25%)</li> </ul> | <ul style="list-style-type: none"> <li>55%</li> <li>0.25%</li> <li>0.25%</li> </ul> | Super Sani-Cloth® Germicidal Disposable Wipe by Nice-Pak/PDI, Inc. | 2 minutes        |
| <ul style="list-style-type: none"> <li>Quaternary ammonium compounds, C12- 18-alkyl [(ethylphenyl) methyl] dimethyl, chlorides</li> <li>Benzyl-C12-18-alkyldimethyl ammonium chlorides</li> </ul>                                         | <ul style="list-style-type: none"> <li>0.14%</li> <li>0.14%</li> </ul>              | Sani-Cloth® AF3 Germicidal Disposable Wipe by Nice-Pak/PDI, Inc.   | 3 minutes        |

- Using a wipe specified above, wipe the holster to remove visible contamination.
- Repeat Step 1 until no visible contamination is present. Additional wipes may be necessary to remove all visible contamination.

### Disinfecting the EX Holster

A low-level disinfection process must follow the cleaning procedure. The disinfectant wipes approved for use with the EX holster are detailed in the "Cleaning the EX Holster" section.

- Using a new wipe, thoroughly wipe the holster to maintain the specified contact time, per the wipe manufacturer's instructions. (See the table above.) Additional wipes may be necessary to maintain the specified wet contact time.
- Allow the holster to air dry. Do not expose the device to heat greater than 54°C.

**NOTE:** Disinfected products should be stored in a dry clean environment, protected from contamination, direct sunlight, pests, and extreme temperature and humidity.

The Mammotome revolve EX holster has an expected life of 1,400 reprocessing cycles.

### Cleaning the Holster Holder

After each use, manually clean the holster holder using a commercial wipe.

1. Using a new wipe, thoroughly wipe the holster holder to maintain the specified contact time, per the wipe manufacturer's instructions. (See the table above.) Additional wipes may be necessary to maintain the specified wet contact time.
2. Allow the holster holder to air dry. Do not expose the device to heat greater than 54°C.

### **Cleaning the Remote Keypad: Option 1**

After each use, manually clean the remote keypad thoroughly using a pH-neutral enzymatic detergent. Proceed with manual cleaning:

1. Prepare a pH-neutral detergent or pH-neutral enzymatic detergent according to the manufacturer's directions.
2. Use a soft, clean cloth lightly moistened with the cleaning solution to manually clean all surfaces (including crevices).
3. To rinse, wipe thoroughly using a soft, clean cloth lightly moistened with lukewarm (27°C – 44°C) tap water.
4. Dry with a clean, soft cloth.
5. Inspect the device for visible contamination. If contamination is present, repeat steps 1-5 until no visible contamination is present.

### **Cleaning the Remote Keypad: Option 2**

Using Process Chemical Super Sani-Cloth; Sani-Prime Spray (Manufacturer: PDI):

**Additional Cleaning Tool(s):** Soft Bristled Nylon Brush (brush head approximate dimensions: width 9 mm, length 40 mm, individual bristles 9 mm long)

1. Use the specified wipe to wipe all external surfaces, including crevices.
2. Thoroughly scrub crevice areas with a clean, soft bristled nylon brush wetted with the specified spray, for a minimum of 1 minute 10 seconds.
3. Use the specified wipe to thoroughly wipe the device, including crevices, ensuring that a wet surface is maintained for 2.5 minutes.
4. Additional wipes may be used to maintain the 2.5 minute contact time.
5. Allow the keypad to air dry.
6. Perform a visual check to ensure all visible contamination is removed from the surface. If contamination is present, repeat steps 1-4 until no visible contamination is present.

### **Disinfecting the Remote Keypad: Option 1**

An intermediate-level disinfection process must follow the cleaning procedure. The following chemical disinfectants are approved for use with the remote keypad:

- 0.55% Ortho-Phthalaldehyde-based disinfectant (such as CIDEX-OPA)

Disinfectants should be prepared and used according to the manufacturer's recommendations for use, concentration, and contact time. The use of disinfectants other than those specified in these instructions should be assessed for equivalency before using. Technical data sheets are typically available through the manufacturers' web pages to assist in this assessment. Any disinfection process, including tools and

solutions, may influence the wear of a device or equipment.

1. Soak a clean cloth in the disinfectant solution. Squeeze the cloth thoroughly to remove all excess solution.
2. Thoroughly wipe down all surfaces (including crevices) of the remote keypad ensuring that a slightly wet surface is maintained for five minutes.
3. Sterile gauze or a clean, soft cloth moistened with purified water should be used to remove the disinfectant from the device. Repeat four additional times to thoroughly remove residue.
4. Dry the remote keypad with a clean, soft cloth and ensure the cloth is inserted into the crevices of the device.

### **Disinfecting the Remote Keypad: Option 2**

Using Process Chemical Super Sani-Cloth (Manufacturer: PDI):

1. Use the specified wipe to thoroughly wipe down the device, including crevices, ensuring that a wet surface is maintained for 2 minutes.

**Note:** Pay special attention to crevices.

**Note:** Additional wipes may be used to maintain the 2 minute contact time.

2. Allow the keypad to air dry.

**NOTE:** In the applied cleaning and disinfection process, ensure that detergent and disinfectant residuals are sufficiently removed. Purified or deionized water should be used during final rinsing processes; where applicable. (Multiple rinses may be required.) Refer to the manufacturer's recommendations for the removal of disinfectant residuals.

## Chapter 8 SOFTWARE DESCRIPTION

### Touchscreens and Screen Button Functions

The Mammotome revolve Dual Vacuum-Assisted Biopsy System software guides users through the following functions using touchscreens via Graphic User Interface (GUI) on the control module.

#### Device Confirmation and Initialization Screens

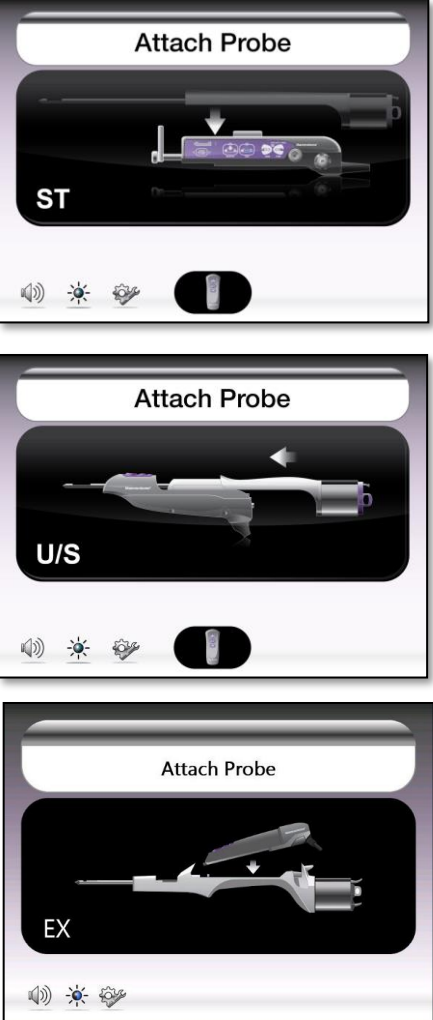
|                                                                                                                                                                                                                                                                                                                                                                                                                                                                                                                                                                                                                                            |                                                                                     |
|--------------------------------------------------------------------------------------------------------------------------------------------------------------------------------------------------------------------------------------------------------------------------------------------------------------------------------------------------------------------------------------------------------------------------------------------------------------------------------------------------------------------------------------------------------------------------------------------------------------------------------------------|-------------------------------------------------------------------------------------|
| <p><b>Searching for Holster Screen</b></p> <ul style="list-style-type: none"><li>• This screen is displayed when the control module has been turned on but a holster is not detected. A holster must be attached via the holster connection port to progress past this screen.</li><li>• If a remote input device is detected, such as a remote footswitch or remote keypad, it appears at the bottom of this screen.</li></ul>                                                                                                                                                                                                            |   |
| <p><b>Searching for Probe Screen</b></p> <ul style="list-style-type: none"><li>• This screen is displayed when the control module has been turned on and the system detects a holster, but no probe is attached. The user must attach a probe to the connected holster to proceed.</li><li>• This is also a standby state that confirms which devices are connected to the control module. If a remote input device is detected, its icon appears at the bottom of this screen.</li><li>• The holster description appears in the lower left-hand corner to confirm the type of holster that has been attached (ST or U/S or EX).</li></ul> |  |

### Proceed to Initialization Screen

- This screen is displayed when the control module has been turned on, and the system detects a probe attached to the holster.
- The user must touch the forward arrow button on the touchscreen to proceed to system initialization.
- If the system is turned on with a holster and probe attached, the start-up process takes the user to this screen.

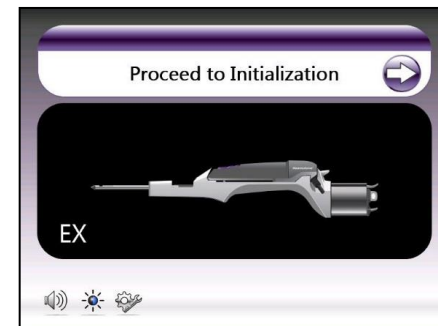
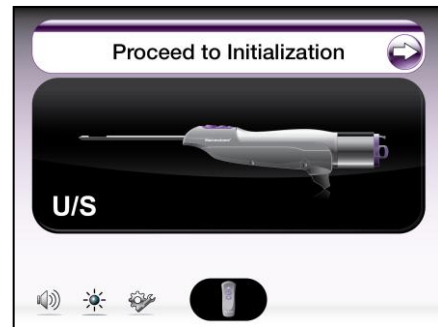

### Select Side of Holster Screen (ST only)

- This screen is displayed once the system is initialized, prompting the user to select the side of the holster that will be used during the procedure.
- When this screen is displayed on the control module, the ST holster displays flashing blue LEDs.
- The user can press and hold any flashing button on either side of the holster to select the desired side and move past this screen.

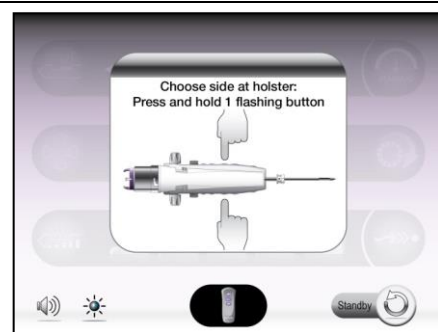

## ST and U/S Procedure Screens

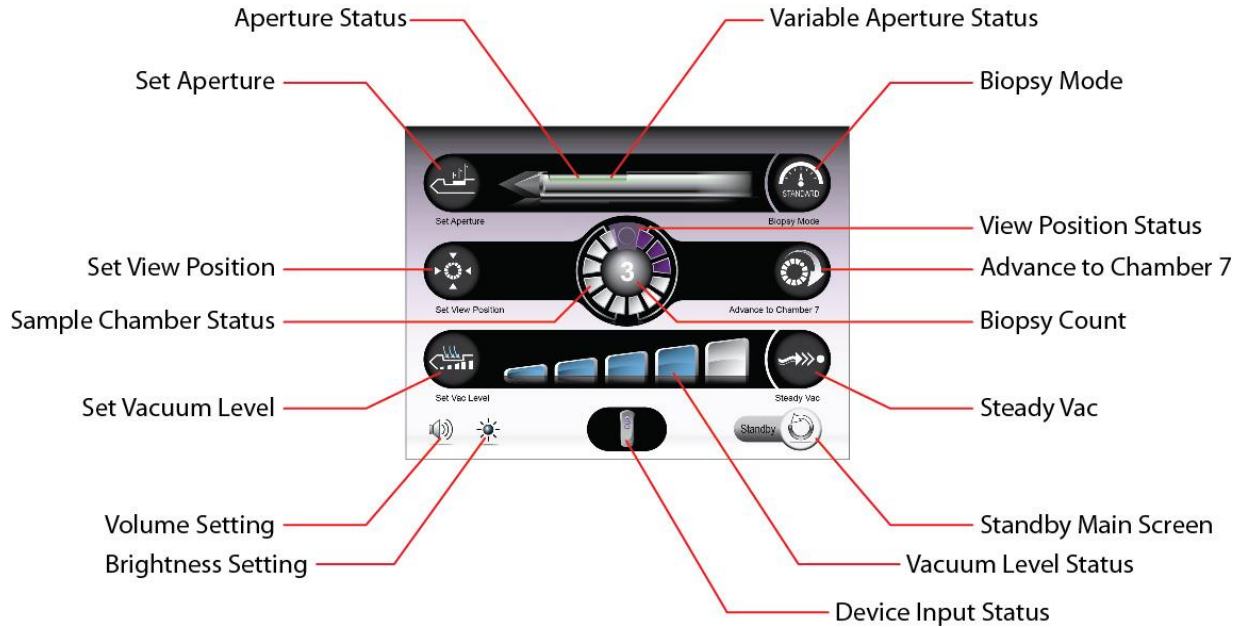

### Procedure Ready Screen

- This screen is displayed once the system is fully initialized and ready to perform clinical functions.
- In this screen, the user can adjust the following procedure settings:
  - Set Aperture
  - Adjust Biopsy Mode
  - Set Specimen View Position
  - Advance to Chamber 7/Reset Chambers
  - Set Vacuum Level
  - Turn SteadyVac ON/OFF
  - Volume
  - Screen Brightness
- During tissue sampling or other clinical functions, the graphics on the screen reflect the function being performed by the system. The touch buttons are lit when the setting they control is available to be adjusted. When the function is not available (i.e. during tissue sampling) the corresponding button is dim.

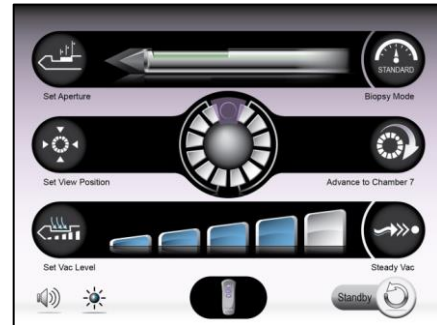

## Set Aperture



- On this Confirm Selection Screen, the user can select one of three options for the length of the sample aperture:
  - 12mm
  - 18mm
  - Full aperture
- At Full aperture settings, the 8G Mammotome revolve probe has a 23mm aperture, and the 10G Mammotome revolve probe has a 19mm aperture.
- *To adjust the setting:* First, touch the “Set Aperture” button. Then touch the desired aperture length shown on the screen.
- **Default Setting:** Full Aperture



## Adjust Biopsy Mode



- The user can toggle through one of three options for Biopsy Mode:
  - High Speed
  - Standard
  - Low Saline
- This setting adjusts the speed of the cutter rotation, translation, and vacuum dwell time at the sample aperture, affecting how fast the system takes a tissue sample. Standard Speed provides consistent sampling across a range of tissue types.
- System shutdown returns the biopsy mode to the default setting. However, initiating a new procedure from the standby state (i.e. not full shutdown) retains the speed setting.

**Default Setting:** Standard Speed



**Set View Position**



- On this Confirm Selection Screen, the user can select from four distinct viewing locations for the most recent tissue sample obtained to be presented for visual inspection.
- When a tissue sample is retrieved, it is always deposited into the “top” viewing position first (in line with the alignment indicator on the probe). If an alternate viewing position has been selected, the chambers then rotate to present the specimen to the user in the selected location.
- *To adjust the setting:* First, touch the “Set View Position” button. Then, touch the desired position setting that is available on the screen.

**Default Setting:** Aligned with Alignment Indicator on Probe Body.



## Advance to Chamber 7/Reset Chambers



## Advance to Chamber 7 / Reset Chambers

### Advance to Chamber 7

- The Advance to Chamber 7 function is used to skip the remaining chambers in the first set, to start acquiring tissue samples in the second set of chambers (7-12) in the specimen management system.
- The top center circle of the graphic depiction on the touchscreen represents the marker chamber. Chamber status is represented by three colors:
  - **Purple:** Attempted tissue sample
  - **Dark Grey:** Skipped/Advanced chamber
  - **Light Grey:** Available chamber

**NOTE:** If the first set of chambers (1-6) is removed during the procedure (e.g., for specimen radiograph), the system can continue to perform clinical functions and retrieve tissue samples into the second set of chambers (7-12) if “Advance to Chamber 7” is activated.

### Reset Chambers (continued)

- The Reset Chamber function resets the graphic image of the specimen management system on the Touchscreen interface.
- The Reset Chamber function is used when a new specimen management system is placed on the probe. Selecting “Reset Chambers” prompts the system to calibrate proper chamber location, as well as resetting the graphic representation of the number of samples attempted on the Touchscreen interface.

The system cannot detect when a specimen management system has been removed from or installed on the probe. Therefore, it is necessary to use the Reset Chambers button when a new specimen management system is installed on the probe.

### Advance to Chamber 7

(Example below: Three samples have been attempted. “Advance to Chamber 7” is available for activation.)

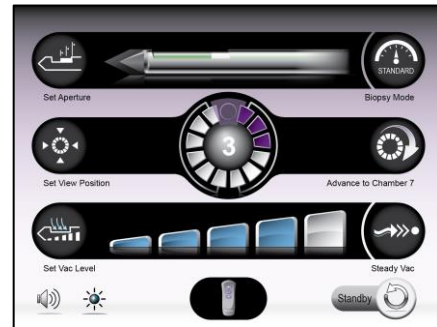

### Reset Chambers (continued)

(Example below: Three samples were attempted into chambers 1-3, then “Advance to Chamber 7” was activated to skip Chambers 4-6. The next sample will deposit in Chamber 7. The “Reset Chambers” function is now available for activation if a new Specimen Management System is installed.)

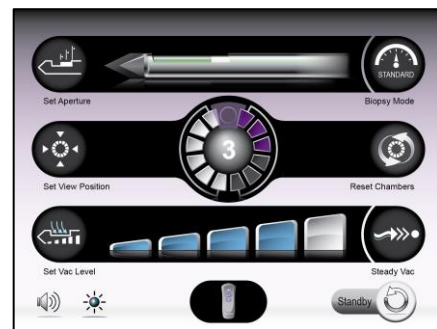

## Biopsy Counter

- This number is seen in the center of the SMS graphic and represents the number of attempted samples taken during the biopsy procedure for a single probe. The number increases as each sample is attempted for a single probe.
- The biopsy counter automatically resets when a probe is removed from the holster. The user may manually clear the count immediately after “Reset Chambers” is executed by pressing and holding the center of the SMS graphic for ~2 seconds.
- After probe initialization, as long as the probe remains attached to the holster and the user does not manually clear the count, the count tracks the number of times the BIOPSY function is executed, even if chambers have been advanced and/or reset, a new SMS cup has been placed on the original probe, or a probe has been placed in standby then returned to the procedure to continue sampling.

**NOTE:** Before any samples are attempted, no number shows on the biopsy counter. If manually cleared after sampling, the count clears to zero (0).

**NOTE:** This number tracks the number of times the BIOPSY function is executed. It **DOES NOT** represent the number of chambers in the SMS, or the number of the active SMS chamber.

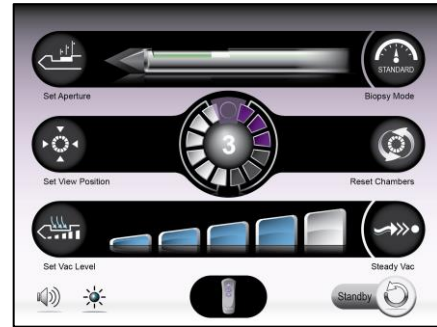

## Set Vacuum Level



- On this Confirm Selection Screen, the user can adjust the vacuum level of the system. The default vacuum level at startup is represented by the middle bar in the graphic. If ambient air pressure is too low for the pump to create the default vacuum, the graphic shows the highest attainable vacuum level as the first or second bar in the graphic.
- System shutdown returns the vacuum level to the default setting.
- *To adjust setting:* First, touch the “Set Vac Level” button. Then touch the desired vacuum level bar that is available on the screen.
- **Default Setting:** 24 in./Hg, or the closest attainable vacuum level.

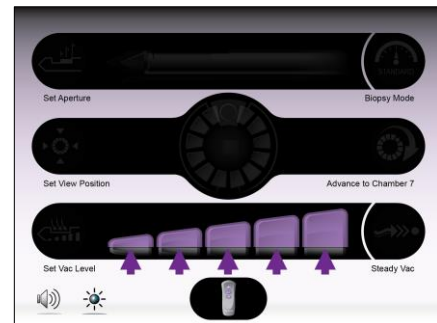

## SteadyVac



- This setting directs the system to apply a continuous and low-level vacuum to keep the biopsy cavity, probe, and tubing clear, to minimize clogging and incidence of hematoma at the biopsy cavity.
- Press the touchscreen icon once to turn the function on. Press again to turn it off.

Pressing a clinical function button (e.g. BIOPSY, VAC, Open/Close) while SteadyVac is on disables SteadyVac and returns the system to Ready state.

(Example below: SteadyVac is ON.)

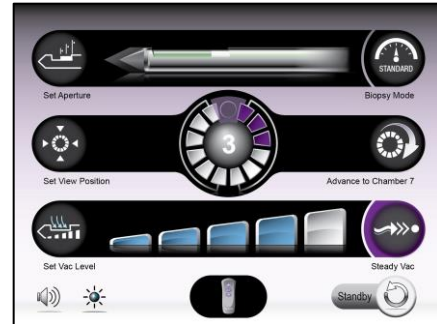

## Volume and Screen Brightness

- Volume and Brightness settings can be accessed from any screen and allow the user to adjust the system volume level and touchscreen brightness for better audible and visible feedback.
- Changes to the volume and screen brightness levels are saved on system shutdown and will return to the previously set level the next time the system is powered on.
- **First Time Use Default Setting:**
  - Volume: Medium
  - Screen Brightness: High

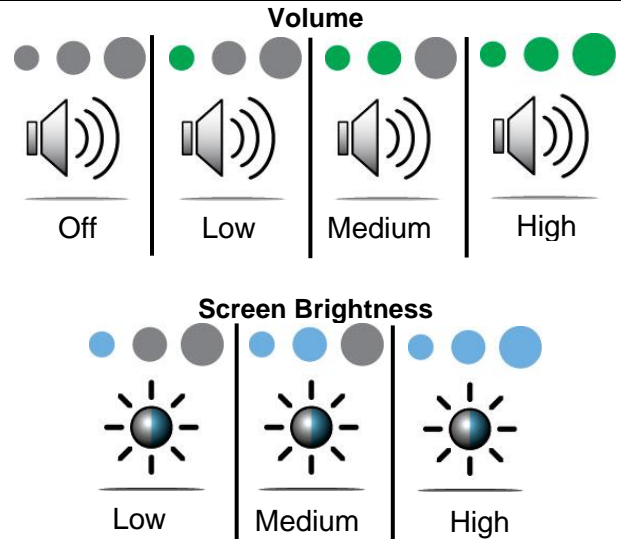

## EX Procedure Screens

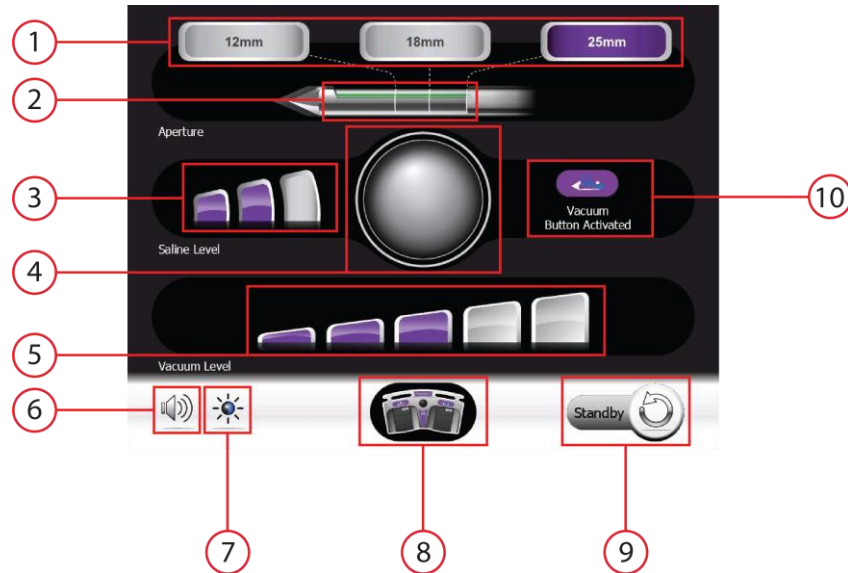

1. Set Aperture Buttons and Status
2. Aperture and Cutter Position Indicator
3. Saline Level Buttons and Status
4. Biopsy Count Location and Count Reset Button
5. Vacuum Level Buttons and Status
6. Volume Level Button
7. Brightness Level Button
8. Keypad/Footswitch Indicator
9. Standby Button
10. Button Activation Indicator

### **Procedure Ready Screen**

- This screen is displayed once the system is fully initialized and ready to perform clinical functions.
- In this screen, the user can adjust the following procedure settings:
  - Set Aperture
  - Adjust Saline Level
  - Adjust Vacuum Level
  - Volume
  - Screen Brightness
- During tissue sampling or other clinical functions, the graphics on the screen reflect the function being performed by the system. The touch buttons are lit when the setting they control are available to be adjusted. When the function is not available (i.e. during tissue sampling) the corresponding button is dim.

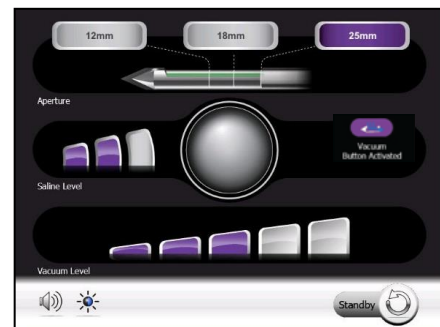

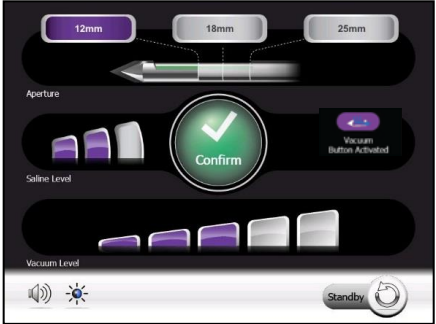
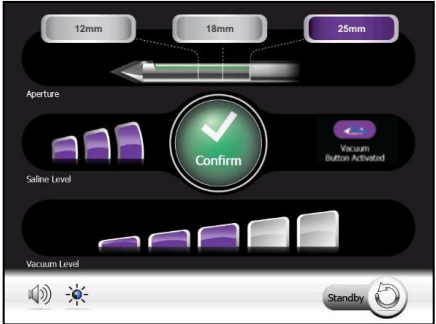
| <b>Set Aperture</b>                                                                                                                                                                                                                                                                                                                                                                                                                                                                                                                                              | 12mm                                                                                | 18mm | 25mm |
|------------------------------------------------------------------------------------------------------------------------------------------------------------------------------------------------------------------------------------------------------------------------------------------------------------------------------------------------------------------------------------------------------------------------------------------------------------------------------------------------------------------------------------------------------------------|-------------------------------------------------------------------------------------|------|------|
| <ul style="list-style-type: none"> <li>On this Confirm Selection Screen, the user can select one of three options for the length of the sample aperture: <ul style="list-style-type: none"> <li>12 mm</li> <li>18 mm</li> <li>25 mm (Full Aperture)</li> </ul> </li> <li><i>To adjust the setting:</i> First, touch the aperture size desired. Then touch the Confirm button shown on the screen.</li> <li>The Aperture length returns to the default setting after initialization of a probe.</li> <li><b>Default Setting:</b> 25 mm (Full Aperture)</li> </ul> |   |      |      |
| <b>Adjust Saline Level</b>                                                                                                                                                                                                                                                                                                                                                                                                                                                                                                                                       |                                                                                     |      |      |
| <ul style="list-style-type: none"> <li>The user can select one of three levels for usage during Biopsy: <ul style="list-style-type: none"> <li>Low</li> <li>Medium</li> <li>High</li> </ul> </li> <li>This setting adjusts the amount of saline to be used during the Biopsy cycle. A higher level provides more saline during sampling.</li> <li>The Saline Level returns to the default setting after initialization of a probe.</li> </ul> <p><b>Default Setting:</b> Low</p>                                                                                 |  |      |      |

### Biopsy Counter

- This number is seen in the center of the SMS graphic and represents the number of attempted samples taken during the biopsy procedure for a single probe. The number increases as each sample is attempted for a single probe.
- The biopsy counter automatically resets when a probe is removed from the holster. The user may manually clear the count by pressing and holding the center of the SMS graphic for ~2 seconds.
- After probe initialization, if the probe remains attached to the holster and the user does not manually clear the count, the count tracks the number of times the BIOPSY function is executed, even when a probe has been placed in standby then returned to the procedure to continue sampling.

**NOTE:** Before any samples are attempted, no number show on the biopsy counter. If manually cleared after sampling, the count clears to zero (0).

**NOTE:** This number tracks the number of times the BIOPSY function is executed. It **DOES NOT** represent the number of chambers in the SMS, or the number of the active SMS chamber



### Set Vacuum Level

- On this Confirm Selection Screen, the user can adjust the vacuum level of the system. The default vacuum level at startup is represented by the middle bar in the graphic. If ambient air pressure is too low for the pump to create the default vacuum, the graphic shows the highest attainable vacuum level as the first or second bar in the graphic.
- System shutdown returns the vacuum level to the default setting.
- *To adjust setting:* First, touch the available vacuum level bar desired. Then touch the Confirm button shown on the screen.
- **Default Setting:** Level 3, or the closest attainable vacuum level.

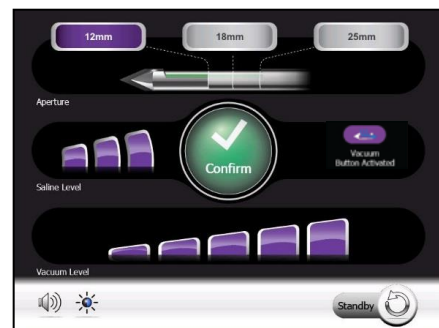

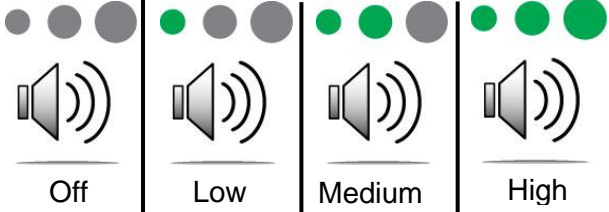
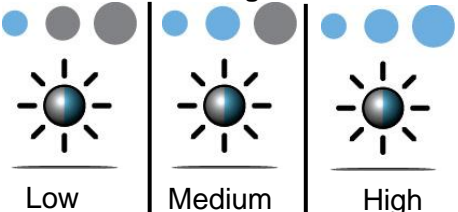
| <b>Volume and Screen Brightness</b>                                                                                                                                                                                                                                                                                                                                                                                                                                                                                                                                                 |                                                                                                                                                                                                                                                                                                                                                                                                           |
|-------------------------------------------------------------------------------------------------------------------------------------------------------------------------------------------------------------------------------------------------------------------------------------------------------------------------------------------------------------------------------------------------------------------------------------------------------------------------------------------------------------------------------------------------------------------------------------|-----------------------------------------------------------------------------------------------------------------------------------------------------------------------------------------------------------------------------------------------------------------------------------------------------------------------------------------------------------------------------------------------------------|
| <ul style="list-style-type: none"> <li>• Volume and Brightness settings can be accessed from any screen and allow the user to adjust the system volume level and touchscreen brightness for better audible and visible feedback.</li> <li>• Changes to the volume and screen brightness levels are saved on system shutdown and will return to the previously set level the next time the system is powered on.</li> <li>• <b>First Time Use Default Setting:</b> <ul style="list-style-type: none"> <li>○ Volume: Medium</li> <li>○ Screen Brightness: High</li> </ul> </li> </ul> | <div style="text-align: center;"> <p><b>Volume</b></p>  <p>Off      Low      Medium      High</p> </div> <div style="text-align: center; margin-top: 20px;"> <p><b>Screen Brightness</b></p>  <p>Low      Medium      High</p> </div> |



## Standby Screens

### Standby Main Screen



- This screen is displayed when the user places the system into an inactive state. The system displays the detected input devices and holster/probe attachment status. From this screen, a user can perform the following actions:
  - Remove the probe to end a procedure
  - Add a new probe for a new procedure
  - Change input devices (remote footswitch, remote keypad)
  - System shutdown
  - Access System Utilities
  - Adjust Volume and Screen Brightness
- Standby can be accessed any time after device initialization.

**NOTE:** Vacuum system is disabled in standby.

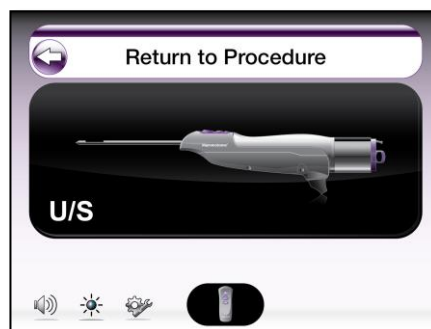

### Shutdown Screen

- To shut down the system, the user must select the green power button on the front of the control module.
- A prompt then appears on the screen to confirm the intended shutdown.
- Touch YES to proceed with shutdown.
  - If YES is selected, the green power button on the front of the control module turns to an **amber** color, indicating the system has shut down.
  - Pressing NO returns to previous screen.
- **NOTE:** When powering down the system, remember that if the power button on the front of the control module is an **amber** color, the system has been shut down but there is still power to the device. To completely turn off the system, complete the shutdown procedure above, then flip the switch at the back of the control module to the OFF position. The power button on the front of the control module is now off.



### Utilities Screens

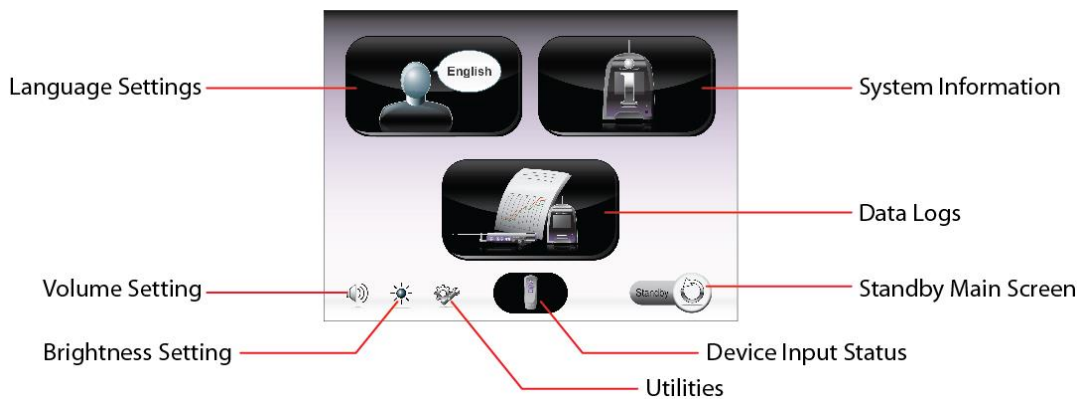

### Utilities Main Screen



- The main utilities screen allows the user to access system utility settings:
  - Change Language
  - Access Data Logs
  - Access System Information
- Utilities can be accessed from the Standby Screen and any time prior to initialization.



### Language Screen

- The Language screen allows the user to view the software screens in alternate languages.
- After a selection has been made, press the Utilities icon to exit the screen.
- Changes to the language setting is saved upon system shutdown and will return to the set language the next time the system is powered on.
- **Default Setting:** English



### Data Logs Screen

- The Data Logs Screen allows the user to view the usage of the control module and holster activities in terms of dates and times.
- After a selection has been made, press the Utilities icon to exit the screen.



### Access System Information Screen

- The Access System Information screen allows the user to view the software version of the control module and holster, as well as the serial number of the holster.
- Press the Utilities icon to exit the screen.



## Chapter 9 SERVICE AND TROUBLESHOOTING

*All information in this guide applies to ST, U/S, and EX unless otherwise stated.*

### Service

Do not attempt to disassemble the holster or electrical cable; doing so will void the product warranty. No user-serviceable parts are located inside the holsters. Refer servicing to qualified personnel or contact customer service through one of the phone numbers listed at the end of this chapter.

**Table 7. Mammotome revolve Dual Vacuum-Assisted Biopsy System Components Troubleshooting Tips**

| Symptom                        | Possible Cause                                          | Corrective Action                                                                                                                                                                                                                                                                                                                                                                                                                                                                           |
|--------------------------------|---------------------------------------------------------|---------------------------------------------------------------------------------------------------------------------------------------------------------------------------------------------------------------------------------------------------------------------------------------------------------------------------------------------------------------------------------------------------------------------------------------------------------------------------------------------|
| System is unresponsive.        | Holster error.                                          | <ul style="list-style-type: none"> <li>Detach the Holster. The system should display the “Attach Holster” prompt.</li> <li>If biopsy is underway, collect samples from the old probe, remove it, and install a new probe.</li> </ul>                                                                                                                                                                                                                                                        |
|                                | Probe error.                                            | <ul style="list-style-type: none"> <li>Detach probe. The system should display the “Attach Probe” prompt.</li> <li>If biopsy is underway, collect samples from the old probe.</li> <li>Attach a new probe to the holster and re-initialize the system.</li> </ul>                                                                                                                                                                                                                           |
|                                | System error.                                           | <ul style="list-style-type: none"> <li>Shut down the system using the on/off button on the front of the CM.</li> <li>If the on/off button is unresponsive, shut down the system using the switch on the rear of the CM.</li> <li>Remove the probe from the holster (collect the samples if biopsy is underway).</li> <li>Disconnect the holster from the CM.</li> <li>Reconnect the holster to the CM.</li> <li>Install a new probe on the holster.</li> <li>Restart the system.</li> </ul> |
| Probe attachment is difficult. | The probe is being loaded onto the holster at an angle. | <ul style="list-style-type: none"> <li>Keep the probe parallel to the holster (along the long axis) when attaching it.</li> </ul>                                                                                                                                                                                                                                                                                                                                                           |

| Symptom                                                                                                            | Possible Cause                                                            | Corrective Action                                                                                                                                                                                                                                                                                                                                                                                                                                                                                                                                                                                                                                                                                               |
|--------------------------------------------------------------------------------------------------------------------|---------------------------------------------------------------------------|-----------------------------------------------------------------------------------------------------------------------------------------------------------------------------------------------------------------------------------------------------------------------------------------------------------------------------------------------------------------------------------------------------------------------------------------------------------------------------------------------------------------------------------------------------------------------------------------------------------------------------------------------------------------------------------------------------------------|
| The Specimen Management System (SMS) collection chambers are not at the anticipated location after initialization. | Probe/holster did not initialize correctly.                               | <ul style="list-style-type: none"> <li>Remove the probe and manually rotate the specimen collection chambers to align with the alignment indicator on the probe, taking care not to pinch or dislodge the chambers. Take care not to pull chambers out of the SMS.</li> </ul> <p><b>NOTE:</b> The probe will make a clicking sound as the SMS chambers are rotated.</p> <ul style="list-style-type: none"> <li>Replace the probe on the holster and proceed through initializations. Once the Procedure Ready Screen appears, the next tissue sample will be deposited into Chamber 1. If Chamber 7 is desired for the next sample, select <i>Advance to Chamber 7</i> on the touchscreen interface.</li> </ul> |
|                                                                                                                    | SMS cup was misaligned prior to attaching the probe to the holster.       | <ul style="list-style-type: none"> <li>Remove the probe from the holster. If biopsy is underway, collect the samples taken, discard the probe, and prepare a new probe for attachment.</li> <li>Manually rotate the SMS cup chambers (not the outer cup) to align the 13<sup>th</sup> chamber with the sample port (marked by an 'M' on the probe body).</li> <li>Reinstall the probe on the holster.</li> <li>Reinitialize the system.</li> </ul>                                                                                                                                                                                                                                                              |
| Irregular gear noise during initialization.                                                                        | Probe is not correctly attached to the holster.                           | <ul style="list-style-type: none"> <li>Remove the probe and reattach it to the holster following instructions in <b>Chapter 3</b>.</li> <li>If noise occurs again, remove the probe and inspect the cutter gear on the probe. If it is not damaged, replace the probe on the holster and proceed through initialization. If the cutter gear is damaged, discard the damaged probe and continue with a new probe.</li> </ul>                                                                                                                                                                                                                                                                                     |
| Cutter remains stuck in the open aperture position.                                                                | A homing error may have occurred.                                         | <ul style="list-style-type: none"> <li>Remove the probe from the holster.</li> <li>Rotate the cutter gear on the bottom of the probe until the aperture is only 1/3 open.</li> <li>Reattach the probe to the holster and reinitialize the system.</li> </ul>                                                                                                                                                                                                                                                                                                                                                                                                                                                    |
| <b>ST Only:</b><br>Probe trocar shaft will not rotate.                                                             | Probe is not correctly attached to the holster.                           | <ul style="list-style-type: none"> <li>Check to ensure the probe is properly seated on the holster and that the aperture rotation thumbwheel is correctly seated in the holster firing fork.</li> </ul>                                                                                                                                                                                                                                                                                                                                                                                                                                                                                                         |
|                                                                                                                    | Holster firing fork screw is loose.                                       | <ul style="list-style-type: none"> <li>Remove the probe.</li> <li>Tighten the firing fork screw with a coin (do not over-tighten the screw).</li> </ul>                                                                                                                                                                                                                                                                                                                                                                                                                                                                                                                                                         |
|                                                                                                                    | Probe guide is installed upside-down or is not fully seated in its mount. | <ul style="list-style-type: none"> <li>Remove the holster from the table mount.</li> <li>Check the probe guide to ensure it is correctly aligned and fully seated in its mount.</li> </ul>                                                                                                                                                                                                                                                                                                                                                                                                                                                                                                                      |
|                                                                                                                    | Holster aperture                                                          | <ul style="list-style-type: none"> <li>Contact Customer Service.</li> </ul>                                                                                                                                                                                                                                                                                                                                                                                                                                                                                                                                                                                                                                     |

| Symptom                                                                                   | Possible Cause                                                                                                          | Corrective Action                                                                                                                                                                                                                                                                              |
|-------------------------------------------------------------------------------------------|-------------------------------------------------------------------------------------------------------------------------|------------------------------------------------------------------------------------------------------------------------------------------------------------------------------------------------------------------------------------------------------------------------------------------------|
|                                                                                           | rotation knobs are broken.                                                                                              |                                                                                                                                                                                                                                                                                                |
| <b>ST Only:</b><br>Trocar shaft rotation appears extremely uneven.                        | Misalignment of the probe guide peak or probe aperture rotation thumbwheel.                                             | <ul style="list-style-type: none"> <li>Remove the probe from the probe guide.</li> <li>Align the peak of the probe guide to align it with the 12.o'clock indicator on the probe's aperture rotation thumbwheel.</li> </ul>                                                                     |
| Specimen samples are not consistently transporting into the specimen collection chambers. | Lateral line pinch valve is engaged, preventing vacuum flow.                                                            | <ul style="list-style-type: none"> <li>Disengage the pinch valve on the lateral line.</li> </ul>                                                                                                                                                                                               |
|                                                                                           | Stopcock valve has closed off the axial vacuum line, preventing vacuum flow.                                            | <ul style="list-style-type: none"> <li>Turn the stopcock valve indicator to open the axial vacuum line.</li> </ul>                                                                                                                                                                             |
|                                                                                           | Valve cartridge is not properly seated in the control module vacuum connection slot.                                    | <ul style="list-style-type: none"> <li>Ensure the valve cartridge is properly attached to the control module.</li> </ul>                                                                                                                                                                       |
|                                                                                           | Vacuum canister is full of fluid. Overfill protection is active.                                                        | <ul style="list-style-type: none"> <li>Discard the vacuum canister in the appropriate container.</li> <li>Replace the vacuum canister.</li> </ul>                                                                                                                                              |
|                                                                                           | Aperture has not been rotated (indicated by fluid, but no sample, appearing in the SMS).                                | <ul style="list-style-type: none"> <li>Rotate the aperture to the next orientation between samples.</li> </ul>                                                                                                                                                                                 |
|                                                                                           | Saline bag is empty or improperly attached.                                                                             | <ul style="list-style-type: none"> <li>Check the saline bag for adequate saline.</li> <li>Check the saline tubing for kinks or damaged/undone connectors.</li> </ul>                                                                                                                           |
| Clear/Dry Tap function does not transport tissue or fluid into the SMS.                   | Vacuum button was pressed for too long or too quickly.                                                                  | <ul style="list-style-type: none"> <li>Press the Vacuum button quickly, but long enough to ensure it makes contact.</li> </ul>                                                                                                                                                                 |
|                                                                                           | No saline in the system.                                                                                                | <ul style="list-style-type: none"> <li>Check the saline bag for adequate saline.</li> <li>Check the saline tubing for kinks or damaged/undone connectors.</li> </ul>                                                                                                                           |
| A sample appears in a different chamber than where it is expected.                        | The SMS was misaligned before the probe was attached.                                                                   | <ul style="list-style-type: none"> <li>Note the location of the samples in relation to the expected position. If more samples are desired, remove the probe and install a new one, checking to ensure the new probe's SMS is properly aligned before it is attached to the holster.</li> </ul> |
|                                                                                           | The View Sample function is on, and the user is pressing and holding the Vacuum button. This could transport a specimen | <ul style="list-style-type: none"> <li>Note that the unexpected sample may be part of the previous sample attempted.</li> </ul>                                                                                                                                                                |

| Symptom                                                                                              | Possible Cause                                                                                 | Corrective Action                                                                                                                                                                                                                                                                                                                                                                                                                      |
|------------------------------------------------------------------------------------------------------|------------------------------------------------------------------------------------------------|----------------------------------------------------------------------------------------------------------------------------------------------------------------------------------------------------------------------------------------------------------------------------------------------------------------------------------------------------------------------------------------------------------------------------------------|
|                                                                                                      | into a different chamber than the expected one.                                                |                                                                                                                                                                                                                                                                                                                                                                                                                                        |
| Sample aperture is not fully closed after initialization.                                            | Probe/Holster did not initialize correctly.                                                    | <ul style="list-style-type: none"> <li>Disconnect the holster cable from the Control Module, reattach it, and proceed through initialization again.</li> </ul> <p style="text-align: center;"><b>OR</b></p> <ul style="list-style-type: none"> <li>Remove the probe from holster, reattach it and proceed through initialization again.</li> </ul>                                                                                     |
| Function buttons are not responding.                                                                 | The system executes a different function than the one expected when the user presses a button. | <ul style="list-style-type: none"> <li>Be sure to press the buttons for the proper duration for a desired function. Pressing a button for too long (or too quickly) can activate the wrong function.</li> <li>Remember that the function buttons on the holster, footswitch, and keypad are all in different order; do not look at the holster's buttons when trying to activate a function using the keypad or footswitch.</li> </ul> |
|                                                                                                      | The system is still executing a previous command.                                              | <ul style="list-style-type: none"> <li>Wait until the previous function has finished before pressing a button for the next function.</li> </ul>                                                                                                                                                                                                                                                                                        |
|                                                                                                      | The user bumped a feature button on the GUI, and the system is no longer in Ready mode.        | <ul style="list-style-type: none"> <li>Determine which feature button was pressed, then set that feature to the desired setting and confirm it. The system will return to Ready mode.</li> </ul>                                                                                                                                                                                                                                       |
| <b>ST Only:</b><br>Attempt to ARM the holster and probe, but the probe trocar shaft does not engage. | Arming motor failure.                                                                          | <ul style="list-style-type: none"> <li>Call Customer Service.</li> </ul>                                                                                                                                                                                                                                                                                                                                                               |
| <b>ST Only:</b><br>Holster/probe is ARMED but will not FIRE.                                         | Mechanical safety release and/or FIRE buttons are not fully pressed.                           | <ul style="list-style-type: none"> <li>Ensure the mechanical safety release and FIRE buttons are simultaneously and fully pressed.</li> </ul>                                                                                                                                                                                                                                                                                          |
|                                                                                                      | Arming motor failure.                                                                          | <ul style="list-style-type: none"> <li>Remove the holster and probe as a single unit from the biopsy site, then remove the probe from the holster.</li> </ul> <p style="text-align: center;"><b>AND</b></p> <p>Call Customer Service.</p>                                                                                                                                                                                              |
| Vacuum leak is audible during tissue sampling.                                                       | Specimen collection chambers are dislodged from the SMS.                                       | <ul style="list-style-type: none"> <li>Ensure the specimen collection chambers are seated correctly in the SMS.</li> <li>Check the vacuum tube set connections.</li> </ul>                                                                                                                                                                                                                                                             |
| Vacuum pump creates a loud noise when in operation.                                                  | Natural pump vibration could cause loud noise during operation.                                | <ul style="list-style-type: none"> <li>Check to ensure the control module is secured to the cart with the mounting thumbscrews (supplied with the cart).</li> </ul>                                                                                                                                                                                                                                                                    |

| Symptom                                                                                                                  | Possible Cause                                                                                                     | Corrective Action                                                                                                                                                                                                                                                                                                                                                                                                      |
|--------------------------------------------------------------------------------------------------------------------------|--------------------------------------------------------------------------------------------------------------------|------------------------------------------------------------------------------------------------------------------------------------------------------------------------------------------------------------------------------------------------------------------------------------------------------------------------------------------------------------------------------------------------------------------------|
| Fluid does not visibly move in the vacuum tubing when the Vacuum button is pressed and released.                         | Vacuum button is being held too long to trigger Clear/Dry Tap, but not long enough to trigger the Vacuum function. | <ul style="list-style-type: none"> <li>Adjust the length of time the user is pressing the button: faster for Clear/Dry Tap, longer for Vacuum.</li> </ul>                                                                                                                                                                                                                                                              |
| With the SMS removed from the probe, fluid is leaking from the probe's marker insertion port.                            | Probe is clogged.                                                                                                  | <ul style="list-style-type: none"> <li>Fully close the sample aperture and apply VACUUM.</li> </ul>                                                                                                                                                                                                                                                                                                                    |
| Cannot insert the valve cartridge into the control module's vacuum connection slot.                                      | Misalignment of the valve slots.                                                                                   | <ul style="list-style-type: none"> <li>Manually align the valve cartridge T-slots with the orientation of the control module valve actuators.</li> </ul> <p style="text-align: center;"><b>OR</b></p> <ul style="list-style-type: none"> <li>Proceed through initialization without the valve cartridge attached to reset the valve alignment, and then reattach the valve cartridge to the control module.</li> </ul> |
| Marker insertion is difficult.                                                                                           | If inserting the marker through the cup, the cup is not aligned.                                                   | <ul style="list-style-type: none"> <li>Gently nudge the SMS manifold until the 13<sup>th</sup> chamber is aligned with the sample port.</li> </ul>                                                                                                                                                                                                                                                                     |
|                                                                                                                          | Marker was inserted into the wrong SMS manifold chamber.                                                           | <ul style="list-style-type: none"> <li>Make sure the marker is inserted into the chamber aligned with the sample port.</li> </ul>                                                                                                                                                                                                                                                                                      |
|                                                                                                                          | The tip of the marker is running into the rear of the cutter.                                                      | <ul style="list-style-type: none"> <li>Make sure the marker is inserted straight into the probe. Pushing the marker in at an angle may cause it to catch on the cutter.</li> </ul>                                                                                                                                                                                                                                     |
| Marker will not insert to the correct depth.                                                                             | Sample was accidentally taken prior to marker insertion.                                                           | <ul style="list-style-type: none"> <li>Reinstall the SMS cup (if removed for marker insertion).</li> <li>Perform a Clear/Dry Tap function to clear the sample.</li> <li>Remove the SMS cup (if desired) and reinsert the marker.</li> </ul>                                                                                                                                                                            |
|                                                                                                                          | Incorrect needle length chosen/used.                                                                               | <ul style="list-style-type: none"> <li>Double-check measurements to ensure the correct needle was used for the procedure.</li> </ul>                                                                                                                                                                                                                                                                                   |
| For additional causes and corrections related to Mammotome revolve markers, refer to Deployment Guide of the marker IFU. |                                                                                                                    |                                                                                                                                                                                                                                                                                                                                                                                                                        |
| Cutter moves while the marker is in the probe.                                                                           | The user may have tapped the Vacuum button while rotating the needle, triggering a Clear/Dry Tap function.         | <ul style="list-style-type: none"> <li>If vacuum is desired while a marker is inserted, the user must be careful to press and hold the Vacuum button to activate the vacuum function.</li> </ul>                                                                                                                                                                                                                       |



**Table 8. Mammotome revolve Dual Vacuum-Assisted Biopsy System Software Troubleshooting Tips**

| <b>Symptom</b>                                                                                                            | <b>Possible Cause</b>                                                   | <b>Corrective Action</b>                                                                                                                                                                                                                                                                                                                                                                  |
|---------------------------------------------------------------------------------------------------------------------------|-------------------------------------------------------------------------|-------------------------------------------------------------------------------------------------------------------------------------------------------------------------------------------------------------------------------------------------------------------------------------------------------------------------------------------------------------------------------------------|
| System reports “Control Module Malfunction” when powered on.                                                              | Control module malfunction.                                             | <ul style="list-style-type: none"> <li>• Call Custom Service and report the error code displayed.</li> </ul>                                                                                                                                                                                                                                                                              |
| System reports “Vacuum Error”                                                                                             | Vacuum tubing is not connected.                                         | <ul style="list-style-type: none"> <li>• Ensure the vacuum tubing is connected to the probe and the vacuum canister, and that the valve cartridge is fully seated into the control module’s connection slot.</li> </ul>                                                                                                                                                                   |
|                                                                                                                           | Vacuum canister is cracked.                                             | <ul style="list-style-type: none"> <li>• Replace the canister. Check canisters for cracks prior to system startup.</li> </ul>                                                                                                                                                                                                                                                             |
|                                                                                                                           | Sample trays in the SMS are not fully seated in the cup.                | <ul style="list-style-type: none"> <li>• Gently push the sample trays into the SMS manifold.</li> </ul>                                                                                                                                                                                                                                                                                   |
| System reports holster is not compatible: <b>Error Code 203.</b>                                                          | The control module and the holster have incompatible software versions. | <ul style="list-style-type: none"> <li>• Use a holster that is compatible with the control module’s current software version.</li> <li>• Call Customer Service to request a software package update.</li> </ul>                                                                                                                                                                           |
| System fails to initialize the probe and reports error message: “Holster Malfunction” <b>Error Code 702, 802, or 902.</b> | Holster malfunction.                                                    | <ul style="list-style-type: none"> <li>• Call Customer Service and report the error code displayed.</li> </ul>                                                                                                                                                                                                                                                                            |
| System fails to initialize the probe and reports error message: “Check or Replace Cup” <b>Error Code 703 or 704.</b>      | Specimen management system is obstructed and cannot move.               | <ul style="list-style-type: none"> <li>• Check for obstructions that block the specimen management system from rotating.</li> <li>• Ensure the SMS assembly is fully locked onto the probe.</li> <li>• Remove the probe from the holster, reattach, and try initialization again.</li> <li>• If the problem persists, call Custom Service and report the error code displayed.</li> </ul> |

| Symptom (continued)                                                                                                                | Possible Cause (continued)                                                                                   | Corrective Action (continued)                                                                                                                                                                                                                                                                                                                                                                                                                 |
|------------------------------------------------------------------------------------------------------------------------------------|--------------------------------------------------------------------------------------------------------------|-----------------------------------------------------------------------------------------------------------------------------------------------------------------------------------------------------------------------------------------------------------------------------------------------------------------------------------------------------------------------------------------------------------------------------------------------|
| <p>System returns to Standby and reports error message: "Vacuum Error, Check Tubing Connections" <b>Error Code 400 or 402.</b></p> | <p>Vacuum canister leak, or vacuum pump is not working properly.</p>                                         | <ul style="list-style-type: none"> <li>• Ensure the vacuum tubing is connected as defined in <b>Chapter 3.</b></li> <li>• Check that all vacuum canister lid ports are sealed.</li> <li>• Repeat system initialization.</li> <li>• If the problem persists, call Customer Service and report the error code displayed.</li> </ul>                                                                                                             |
| <p><b>ST Only:</b><br/>System instructs the user to reinitialize the holster: <b>Error Code 904.</b></p>                           | <p>Holster firing fork has encountered an obstruction or there is an arming motor failure.</p>               | <ul style="list-style-type: none"> <li>• Check for and remove any obstructions that may impede the holster firing fork.</li> <li>• Reinitialize the holster.</li> <li>• If the problem persists, call Customer Service and report the error code displayed.</li> </ul>                                                                                                                                                                        |
| <p>System reports: "Check Holster and Probe Attachment" during function execution. <b>Error Codes 805 – 819.</b></p>               | <p>System is unable to move the cutter due to an obstruction or probe issue.</p>                             | <ul style="list-style-type: none"> <li>• Remove the probe from the patient (collect any samples obtained), disconnect the probe from the system, and replace the probe.</li> <li>• If the problem persists with a new probe, call Customer Service and report the error code displayed.</li> </ul>                                                                                                                                            |
| <p>System reports "Check or Replace Cup" during function execution: <b>Error Codes 705 – 720.</b></p>                              | <p>System is unable to move the specimen management system due to excessive tissue or coagulating blood.</p> | <ul style="list-style-type: none"> <li>• If the problem persists, replace the specimen management system.</li> </ul> <p>If the problem persists with a new specimen management system, replace the probe (collect any samples obtained from the original probe before disposal).</p> <ul style="list-style-type: none"> <li>• If the problem persists with a new probe, call Customer Service and report the error code displayed.</li> </ul> |

| Symptom (continued)                                                                                                                            | Possible Cause (continued)                                                                        | Corrective Action (continued)                                                                                                                                                                   |
|------------------------------------------------------------------------------------------------------------------------------------------------|---------------------------------------------------------------------------------------------------|-------------------------------------------------------------------------------------------------------------------------------------------------------------------------------------------------|
| System displays a message at bottom of the Touchscreen Interface during biopsy: "Probe leak detected." The biopsy function is still available. | Biopsy button was activated outside of the breast, or excessive usage was detected by the system. | <ul style="list-style-type: none"> <li>This is normal operation. The biopsy function will still be available.</li> </ul>                                                                        |
|                                                                                                                                                | Vacuum tubing connections at the probe are loose.                                                 | <ul style="list-style-type: none"> <li>Check/tighten all vacuum connections at the probe and canister.</li> </ul>                                                                               |
|                                                                                                                                                | Tissue strips in the SMS are loose.                                                               | <ul style="list-style-type: none"> <li>Ensure the tissue strips are fully inserted into the SMS.</li> </ul>                                                                                     |
| <b>EX Only:</b><br>System reports: "Probe Error-Reattach Probe" during function execution. <b>Error Code 453.</b>                              | Poor connection between the holster and probe.                                                    | <ul style="list-style-type: none"> <li>Remove the probe from the holster and reattach.</li> </ul>                                                                                               |
| <b>EX Only:</b><br>System reports: "Incompatible Probe – Replace Probe" during function execution. <b>Error Code 451.</b>                      | Incorrect type of probe attached.                                                                 | <ul style="list-style-type: none"> <li>Remove the probe attached to the holster and replace with a new probe.</li> </ul>                                                                        |
| <b>EX Only:</b><br>System reports: "Probe Error – Replace Probe" during function execution. <b>Error Codes 450, 452, 454, 455, 456.</b>        | Unable to connect or communicate the probe with the holster.<br><br>Exceeded biopsy count.        | <ul style="list-style-type: none"> <li>Remove the probe attached to the holster and replace with a new probe.</li> </ul>                                                                        |
| <b>EX Only:</b><br>System displays a message at the center of the Touchscreen Interface: "Check for Tissue"                                    | Biopsy button was activated last and unknown if tissue is remaining in Tissue Viewing Window      | <ul style="list-style-type: none"> <li>If tissue remains in the viewing window, reattach the probe to the holster and initialize to transfer the last tissue to the aligned chamber.</li> </ul> |

### Contact Information

If the symptoms specified in the previous section are inaccurate or the corrective actions are insufficient, consult a qualified hospital technician, call Customer Service at 1-877-926-2666, or email [us.customerservice@mammotome.com](mailto:us.customerservice@mammotome.com). If emailing, please include 1) your account name and number, 2) your contact information, and 3) your question. Once received, a member of the Customer Support Team will reply within one business day.

## Chapter 10 SYSTEM SPECIFICATIONS

### Classification



E350543

MEDICAL – GENERAL MEDICAL EQUIPMENT  
AS TO ELECTRICAL SHOCK, FIRE AND  
MECHANICAL HAZARDS ONLY IN  
ACCORDANCE WITH ANSI/AAMI ES60601-1  
(2005) + AMD 1 (2012), CAN/CSA-C22.2 No.  
60601-1 (2014), IEC 60601-1-6 (2010) + AMD 1  
(2013) AND IEC-62366 (2007) + AMD 1 (2014)

| Product Code(s)                                                                                          | Description                                                                                                                                                                                                                      | DISPOSABLE | REUSABLE |
|----------------------------------------------------------------------------------------------------------|----------------------------------------------------------------------------------------------------------------------------------------------------------------------------------------------------------------------------------|------------|----------|
| <b>MSCM1</b>                                                                                             | Mammotome revolve Control Module                                                                                                                                                                                                 |            | X        |
| <b>MCART1</b>                                                                                            | Mammotome revolve Cart                                                                                                                                                                                                           |            | X        |
| <b>MHEXHOLD1</b>                                                                                         | Mammotome revolve EX Ultrasound Holster Holder                                                                                                                                                                                   |            | X        |
| <b>MSTH1</b>                                                                                             | Mammotome revolve ST Holster                                                                                                                                                                                                     |            | X        |
| <b>MHUSH1</b>                                                                                            | Mammotome revolve U/S Holster                                                                                                                                                                                                    |            | X        |
| <b>MHEXH1</b>                                                                                            | Mammotome revolve EX Holster                                                                                                                                                                                                     |            | X        |
| <b>MST0809</b><br><b>MST0812</b><br><b>MST0815</b><br><b>MST1009</b><br><b>MST1012</b><br><b>MST1015</b> | Mammotome revolve ST Probe <ul style="list-style-type: none"> <li>• 8 gauge, 9 cm</li> <li>• 8 gauge, 12 cm</li> <li>• 8 gauge, 15 cm</li> <li>• 10 gauge, 9 cm</li> <li>• 10 gauge, 12 cm</li> <li>• 10 gauge, 15 cm</li> </ul> | X          |          |
| <b>MHUS08</b><br><b>MHUS10</b>                                                                           | Mammotome revolve U/S Probe <ul style="list-style-type: none"> <li>• 8 gauge</li> <li>• 10 gauge</li> </ul>                                                                                                                      | X          |          |
| <b>MHEX08</b>                                                                                            | Mammotome revolve EX Probe [without sleeve] <ul style="list-style-type: none"> <li>• 8 gauge</li> </ul>                                                                                                                          | X          |          |
| <b>MHEX08S</b>                                                                                           | Mammotome revolve EX Probe [with sleeve] <ul style="list-style-type: none"> <li>• 8 gauge</li> </ul>                                                                                                                             | X          |          |
| <b>MFOOT1</b>                                                                                            | Mammotome revolve Remote Footswitch (optional)                                                                                                                                                                                   |            | X        |
| <b>MHKEYP1</b>                                                                                           | Mammotome revolve Remote Keypad (optional)                                                                                                                                                                                       |            | X        |
| <b>MG08A</b>                                                                                             | 8G Mammotome revolve Disposable Probe Guide                                                                                                                                                                                      | X          |          |
| <b>MG08B</b>                                                                                             | 8G Mammotome revolve Disposable Probe Guide (for GE Upright Systems)                                                                                                                                                             | X          |          |
| <b>MG10A</b>                                                                                             | 10G Mammotome revolve Disposable Probe Guide                                                                                                                                                                                     | X          |          |
| <b>MG10B</b>                                                                                             | 10G Mammotome revolve Disposable Probe Guide                                                                                                                                                                                     | X          |          |

|                   |                                              |   |  |
|-------------------|----------------------------------------------|---|--|
|                   | (for GE Upright Systems)                     |   |  |
| <b>MCANISTER1</b> | Mammotome® revolve Canister                  | X |  |
| <b>MSMB1208</b>   | Mammotome revolve Specimen Management System | X |  |
| <b>MSMB1210</b>   | Mammotome revolve Specimen Management System | X |  |

### Storage/Operating Conditions

|                                           |                                                                                                                                                                                                       |
|-------------------------------------------|-------------------------------------------------------------------------------------------------------------------------------------------------------------------------------------------------------|
| <b>Shipping and Storage</b>               | -18°C to +54°C<br>10% to 95% Relative Humidity ( <b>MSCM1, MCART1, MSTH1, MHUSH1, MHEXH1</b> )<br>10% to 90% Relative Humidity ( <b>MFOOT1, MHKEYP1</b> )<br>500 hPa to 1060 hPa Atmospheric Pressure |
| <b>Environmental Operating Conditions</b> | 5°C to 32°C<br>30% to 75% Relative Humidity<br>810 hPa to 1060 hPa Atmospheric Pressure                                                                                                               |

### Electrical Specifications

|                                                                |                                                                                                                                                                                                                                                                                           |
|----------------------------------------------------------------|-------------------------------------------------------------------------------------------------------------------------------------------------------------------------------------------------------------------------------------------------------------------------------------------|
| <b>Classification</b>                                          | Class I<br>Applied Part Type: B (Mammotome revolve ST Probe)<br>Applied Part Type: B (Mammotome revolve U/S Holster and U/S Probe)<br>Applied Part Type: B (Mammotome revolve EX Probe)                                                                                                   |
| <b>Fluid Ingress</b>                                           | IPX8: Remote Footswitch<br>IPX2: U/S Holster<br>IPX2: EX Holster                                                                                                                                                                                                                          |
| <b>Equipment Operating Conditions</b>                          | <ul style="list-style-type: none"> <li>Voltage: 100 – 240 V~</li> <li>Current: 5A</li> <li>Frequency: 50-60 Hz</li> </ul>                                                                                                                                                                 |
| <b>Fuse Ratings</b>                                            | <ul style="list-style-type: none"> <li>250V</li> <li>5A L</li> <li>Time Lag</li> </ul>                                                                                                                                                                                                    |
| <b>Patient Isolation (Protection Against Electrical Shock)</b> | <ul style="list-style-type: none"> <li>CSA C22.2 No 60601-1 (2014)</li> <li>ANSI/AAMI ES60601-1 (2005+A2)</li> <li>CSA C22.2 No 60601.1 (2008)</li> <li>IEC 60601-1 (2012)</li> <li>UL 60601-1 (2003)</li> <li>CSA C22.2 No 601.1-M90 (2003)</li> <li>IEC 60601-1 (1988+A1+A2)</li> </ul> |
| <b>EMC Compliance</b>                                          | IEC 60601-1-2 (2004, 2007, 2014)                                                                                                                                                                                                                                                          |
| <b>Mode of Operation</b>                                       | Continuous                                                                                                                                                                                                                                                                                |

### Electromagnetic Compatibility (EMC), Guidance and Manufacturer Declarations

The Mammotome revolve Dual Vacuum-Assisted Biopsy System requires special precautions regarding electromagnetic compatibility (EMC) and must be installed and used in accordance with the EMC information provided in this installation guide.

**WARNING:** This medical device emits electromagnetic energy that may interfere with other nearby medical devices, which may cause those devices to malfunction or seriously harm the patient.

| <b>Guidance and Manufacturer's Declaration – Electromagnetic Emissions</b>                                                                                                                                                                                                                                                                                                                                                                                                                                                                                                                                                                                                                                                                                                                                                                                                                                                                                                                                                                                                                                                                                |                   |                                                                                                                                                                                                                                                 |
|-----------------------------------------------------------------------------------------------------------------------------------------------------------------------------------------------------------------------------------------------------------------------------------------------------------------------------------------------------------------------------------------------------------------------------------------------------------------------------------------------------------------------------------------------------------------------------------------------------------------------------------------------------------------------------------------------------------------------------------------------------------------------------------------------------------------------------------------------------------------------------------------------------------------------------------------------------------------------------------------------------------------------------------------------------------------------------------------------------------------------------------------------------------|-------------------|-------------------------------------------------------------------------------------------------------------------------------------------------------------------------------------------------------------------------------------------------|
| <p>The Mammotome revolve Dual Vacuum-Assisted Biopsy System is intended for use in the electromagnetic environments specified below. The customer or user of the Mammotome revolve Dual Vacuum-Assisted Biopsy System should assure that it is used in such an environment.</p>                                                                                                                                                                                                                                                                                                                                                                                                                                                                                                                                                                                                                                                                                                                                                                                                                                                                           |                   |                                                                                                                                                                                                                                                 |
| <b>Emission Test</b>                                                                                                                                                                                                                                                                                                                                                                                                                                                                                                                                                                                                                                                                                                                                                                                                                                                                                                                                                                                                                                                                                                                                      | <b>Compliance</b> | <b>Guidance</b>                                                                                                                                                                                                                                 |
| RF Emissions<br>CISPR 11                                                                                                                                                                                                                                                                                                                                                                                                                                                                                                                                                                                                                                                                                                                                                                                                                                                                                                                                                                                                                                                                                                                                  | Class A           | The Mammotome revolve Dual Vacuum-Assisted Biopsy System uses RF energy only for its internal function. Therefore, its RF emissions are very low and are not likely to cause any interference in nearby electronic equipment.                   |
| RF Emissions<br>CISPR 11                                                                                                                                                                                                                                                                                                                                                                                                                                                                                                                                                                                                                                                                                                                                                                                                                                                                                                                                                                                                                                                                                                                                  | Class A           | The Mammotome revolve Dual Vacuum-Assisted Biopsy System must emit electromagnetic energy to perform its intended function. Nearby electronic equipment may be affected.                                                                        |
| Harmonic Emissions<br>IEC 61000-3-2                                                                                                                                                                                                                                                                                                                                                                                                                                                                                                                                                                                                                                                                                                                                                                                                                                                                                                                                                                                                                                                                                                                       | Class A           | The Mammotome revolve Dual Vacuum-Assisted Biopsy System is suitable for use in non-domestic establishments.                                                                                                                                    |
| Voltage<br>fluctuations/flicker<br>emissions<br>IEC 61000-3-3                                                                                                                                                                                                                                                                                                                                                                                                                                                                                                                                                                                                                                                                                                                                                                                                                                                                                                                                                                                                                                                                                             | Class A           | The Mammotome revolve Dual Vacuum-Assisted Biopsy System is suitable for use in all non-domestic establishments and those directly connected to the public low-voltage power supply network that supplies buildings used for domestic purposes. |
| <p><b>EX Holster Only</b></p> <p><b>FCC Compliance Statement:</b><br/> <i>"This device complies with Part 15 of the FCC rules. Operation is subject to the following two conditions:</i></p> <ol style="list-style-type: none"> <li><i>1. This device may not cause harmful interference, and</i></li> <li><i>2. This device must accept any interference received, including interference that may cause undesired operation:</i></li> </ol> <p><i>"This portable transmitter with its antenna complies with FCC/IC RF exposure limits for general population / uncontrolled exposure."</i></p> <p><b>RSS-Gen. General Requirements for Compliance of Radio Apparatus</b><br/> <i>"This device contains licence-exempt transmitter(s)/receiver(s) that comply with Innovation, Science and Economic Development Canada's licence-exempt RSS(s). Operation is subject to the following two conditions:</i></p> <ol style="list-style-type: none"> <li><i>1. This device may not cause interference.</i></li> <li><i>2. This device must accept any interference, including interference that may cause undesired operation of the device."</i> </li></ol> |                   |                                                                                                                                                                                                                                                 |

| <b>Guidance and Manufacturer's Declaration – Electromagnetic Immunity</b>                                                                                                                                                                           |                                                                                                                                                                                                  |                         |                                                                                                                                                                                                                                                               |
|-----------------------------------------------------------------------------------------------------------------------------------------------------------------------------------------------------------------------------------------------------|--------------------------------------------------------------------------------------------------------------------------------------------------------------------------------------------------|-------------------------|---------------------------------------------------------------------------------------------------------------------------------------------------------------------------------------------------------------------------------------------------------------|
| The Mammutome revolve Dual Vacuum-Assisted Biopsy System is intended for use in the electromagnetic environments specified below. The customer or user of the Mammutome revolve Biopsy System should assure that it is used in such an environment. |                                                                                                                                                                                                  |                         |                                                                                                                                                                                                                                                               |
| <b>Immunity Test</b>                                                                                                                                                                                                                                | <b>IEC 60601-1-2:2014 Test Level</b>                                                                                                                                                             | <b>Compliance Level</b> | <b>Electromagnetic Environment - Guidance</b>                                                                                                                                                                                                                 |
| Electrostatic Discharge IEC 61000-4-2                                                                                                                                                                                                               | ± 8KV Contact<br>± 2KV, ± 4KV, ± 8KV,<br>±15KV Air                                                                                                                                               | PASS                    | Floors should be wood, concrete or ceramic tile. If floors are covered with synthetic material, the relative humidity should be at least 30%.                                                                                                                 |
| Electrical fast transient/burst IEC 61000-4-4                                                                                                                                                                                                       | ± 2KV for power supply lines, 100KHz<br>±1KV signal lines, 100KHz                                                                                                                                | PASS                    | Mains power quality should be that of a typical commercial or hospital environment.                                                                                                                                                                           |
| Surge IEC 61000-4-5                                                                                                                                                                                                                                 | ± 0.5 KV line(s) to lines<br>± 1 KV line(s) to lines<br>± 2 KV lines(s) to earth                                                                                                                 | PASS                    | Mains power quality should be that of a typical commercial or hospital environment.                                                                                                                                                                           |
| Voltage dips, short interruptions, and voltage variations on power supply input lines IEC 61000-4-11                                                                                                                                                | 0 for 0.5 cycle<br>(0,45,90,135,180, 225, 270, 315 degrees)<br>0% for 1 cycle<br>70% for 25 cycles (50 Hz)<br>70% for 30 cycles (60 Hz)<br>0% for 250 cycles (50 Hz)<br>0% for 300 cycles (60Hz) | PASS                    | Mains power quality should be that of a typical commercial or hospital environment. If the user requires continuous operation during power mains interruptions, it is recommended that the system be powered from an uninterruptible power supply or battery. |
| Power frequency (50/60 Hz) magnetic field IEC 61000-4-8                                                                                                                                                                                             | 30 A/m (50 and 60 Hz)                                                                                                                                                                            | PASS                    | Power frequency magnetic fields should be at levels characteristic of a typical location in a commercial or hospital environment.                                                                                                                             |

## System Specifications

| <b>Guidance and Manufacturer's Declaration – Electromagnetic Immunity</b>                                                                                                                                                                                    |                                                                                  |                         |                                                                                                                                                                                                                                                                                                                                                                                                                                                                                                                                                                                                                                                                                                                                                                                                                                                                                                                                                                                                                                                                                         |
|--------------------------------------------------------------------------------------------------------------------------------------------------------------------------------------------------------------------------------------------------------------|----------------------------------------------------------------------------------|-------------------------|-----------------------------------------------------------------------------------------------------------------------------------------------------------------------------------------------------------------------------------------------------------------------------------------------------------------------------------------------------------------------------------------------------------------------------------------------------------------------------------------------------------------------------------------------------------------------------------------------------------------------------------------------------------------------------------------------------------------------------------------------------------------------------------------------------------------------------------------------------------------------------------------------------------------------------------------------------------------------------------------------------------------------------------------------------------------------------------------|
| <p>The Mammotome revolve Dual Vacuum-Assisted Biopsy System is intended for use in the electromagnetic environments specified below. The customer or user of the Mammotome revolve Biopsy System should assure that it is used in such an environment.</p>   |                                                                                  |                         |                                                                                                                                                                                                                                                                                                                                                                                                                                                                                                                                                                                                                                                                                                                                                                                                                                                                                                                                                                                                                                                                                         |
| <b>Immunity Test</b>                                                                                                                                                                                                                                         | <b>IEC 60601 Test Level</b>                                                      | <b>Compliance Level</b> | <b>Electromagnetic Environment - Guidance</b>                                                                                                                                                                                                                                                                                                                                                                                                                                                                                                                                                                                                                                                                                                                                                                                                                                                                                                                                                                                                                                           |
| Conducted RF IEC 61000-4-6                                                                                                                                                                                                                                   | $6V_{rms}$ ISM Band<br>150 KHz to 80 MHz<br><br>$3 V_{rms}$<br>150 KHz to 80 MHz | PASS                    | <p>Portable and mobile RF communications equipment should be used no closer to any part of the Mammotome revolve Biopsy System, including cables, than the recommended separation distance calculated from the equation applicable to the frequency of the transmitter.*</p> <p><b>Recommended separation distance</b><br/> <math>d = [1.17]\sqrt{P}</math> 150 KHz to 80MHz<br/> <math>d = [1.17]\sqrt{P}</math> 80 MHz to 800 MHz<br/> <math>d = [2.33]\sqrt{P}</math> 800 MHz to 2.7 GHz<br/>           where P is maximum output power rating of the transmitter in watts (W) according to the transmitter manufacturer and d is the recommended separation distance in meters (m).<br/>           Field strength from fixed RF transmitters, as determined by an electromagnetic survey, <sup>a</sup> should be less than the compliance level in each frequency range.<sup>b</sup><br/>           Interference may occur in the vicinity of equipment marked with the following symbol:</p>  |
| Radiated RF IEC 61000-4-3                                                                                                                                                                                                                                    | $3 V/m$<br>80 MHz to 2.7 GHz                                                     | PASS                    |                                                                                                                                                                                                                                                                                                                                                                                                                                                                                                                                                                                                                                                                                                                                                                                                                                                                                                                                                                                                                                                                                         |
| Proximity Fields from RF Wireless equipment IEC 61000-4-3                                                                                                                                                                                                    | Per table 9 of IEC 60601-1-2:2014                                                | PASS                    |                                                                                                                                                                                                                                                                                                                                                                                                                                                                                                                                                                                                                                                                                                                                                                                                                                                                                                                                                                                                                                                                                         |
| <p><b>NOTE:</b> At 80 MHz and 800 MHz, the higher frequency range applies.<br/> <b>NOTE:</b> These guidelines may not apply in all situations. Electromagnetic propagation is affected by absorption and reflection from structures, objects and people.</p> |                                                                                  |                         |                                                                                                                                                                                                                                                                                                                                                                                                                                                                                                                                                                                                                                                                                                                                                                                                                                                                                                                                                                                                                                                                                         |



<sup>a</sup> Field strengths from fixed transmitters, such as base stations for radio (cellular/cordless) telephones and land mobile radios, amateur radio, AM and FM radio broadcast and TV broadcast cannot be predicted theoretically with accuracy. To assess the electromagnetic environment due to fixed RF transmitters, an electromagnetic site survey should be considered. If the measured field strength in the location in which the Mammotome revolve Biopsy System is used exceeds the applicable RF compliance level above, the Mammotome revolve Biopsy System should be observed to verify normal operation. If abnormal performance is observed, additional measures may be necessary, such as re-orienting or relocating the Mammotome revolve Biopsy System.

<sup>b</sup> Over the frequency range 150 kHz to 80 MHz, field strengths should be less than 3 V/m.

**Recommended Separation Distances Between Portable and Mobile RF Communications Equipment and the Mammotome revolve Dual Vacuum-Assisted Biopsy System**

The Mammotome revolve Dual Vacuum-Assisted Biopsy System is intended for use in an electromagnetic environment in which radiated RF disturbances are controlled. The customer or user can help prevent electromagnetic interference by maintaining a minimum distance between portable and mobile RF communications equipment (transmitters) and the system as recommended below, according to the maximum output power of the communications equipment.

| Rated maximum output power of transmitter<br>W | Separation distance according to frequency of transmitter<br>m |                                             |                                            |
|------------------------------------------------|----------------------------------------------------------------|---------------------------------------------|--------------------------------------------|
|                                                | 150 KHz to 80 MHz<br>$d = (3.5/v1)\sqrt{P}$                    | 80 MHz to 800 MHz<br>$d = (3.5/E1)\sqrt{P}$ | 800 MHz to 2.7 GHz<br>$d = (7/E1)\sqrt{P}$ |
| 0.01                                           | 0.12                                                           | 0.12                                        | 0.23                                       |
| 0.1                                            | 0.37                                                           | 0.37                                        | 0.74                                       |
| 1                                              | 1.17                                                           | 1.17                                        | 2.33                                       |
| 10                                             | 3.69                                                           | 3.69                                        | 7.38                                       |
| 100                                            | 11.67                                                          | 11.67                                       | 23.33                                      |

For transmitters rated at a maximum output power not listed above, the recommended separation distance *d* in meters (m) can be estimated using the equation applicable to the frequency of the transmitter, where *P* is the maximum output power rating of the transmitter in watts (W) according to the transmitter manufacturer.

**NOTE:** At 80 MHz and 800 MHz, the separation distance for the higher frequency range applies.

**NOTE:** These guidelines may not apply in all situations. Electromagnetic propagation is affected by absorption and reflection from structures, objects and people.

**RFID Frequency Information**

- Working frequencies:13553-13567kHz
- Magnetic field strength at 10 m:not greater than 42dB µA/m (quasi-peak detection).
- Frequency tolerance: <100×10-6.
- Radiated emission within special band: The magnetic field strength at 10 m deviated from 140 kHz frequency range at both ends of the band is not greater than 9dB µA/m (quasi-peak detection).

## WEEE (The Waste Electrical and Electronic Equipment Directive)

---



This symbol on the product(s) and / or accompanying documents means that used electrical and electronic products should not be mixed with general household waste. For proper treatment, recovery and recycling, please take this product(s) to designated collection points where it will be accepted free of charge.

Alternatively, in some countries you may be able to return your products to your local retailer upon purchase of an equivalent new product.

Disposing of this product correctly will help save valuable resources and prevent any potential negative effects on human health and the environment, which could otherwise arise from inappropriate waste handling.

Please contact your local authority for further details of your nearest designated collection point.

Penalties may be applicable for incorrect disposal of this waste, in accordance with your national legislation. For business users in the European Union:

If you wish to discard electrical and electronic equipment, please contact your dealer or supplier for further information.

### Information on Disposal in other Countries outside the European Union:

This symbol is only valid in the European Union. If you wish to discard this product please contact your local authorities or dealer and ask for the correct method of disposal.

## All Other Symbol and Labeling Information

---

For questions or additional information about symbols that appear in this document or on packaging labels, please see [www.mammotome.com](http://www.mammotome.com).

## How Supplied

---

The Mammotome revolve Probes, Specimen Management Systems, Vacuum Tubing Sets, Probe Guides, and Vacuum Canisters are for single-patient use. Discard into an appropriate container after use. All other system components are supplied non-sterile and should be disposed of in accordance with applicable local regulations. For information on material content, contact Devicor Medical Products, Inc.

## Responsibility of the Manufacturer

---

Devicor Medical Products, Inc. is responsible for the safety, reliability, and performance of this equipment only if:

- The person installing the device ensures that the installation, inspection, and any required testing are performed in accordance with the instructions in this manual.
- Persons authorized by Devicor Medical Products, Inc. carry out any and all service, repair, and upgrade operations.
- The equipment is used in accordance with the Mammotome revolve Dual Vacuum-Assisted Biopsy System Operator's Manual.

## Calling for Service

---

Call 1-877-926-2666 within the U.S. or contact your local representative.

Customer support is also available by emailing [us.customerservice@mammotome.com](mailto:us.customerservice@mammotome.com). Please include 1) your account name and number, 2) your contact information and 3) your question. Once received, a member of the Customer Support Team will reply within one business day.

## Requesting a Paper Copy of the Information for Use (IFU)

---

Call 1-877-926-2666 within the U.S. or contact your local representative.

After a request for a paper copy of the IFU is submitted, the paper copy will be sent to the requester within 24 hours.

## Additional Product Information

---

For a complete listing and description of available products for use with the Mammotome revolve Dual Vacuum-Assisted Biopsy System, visit our website: [www.mammotome.com](http://www.mammotome.com).

## Chapter 11 WARRANTY

---

Devicor Medical Products, Inc. warrants this product to be free from defects in material and workmanship under normal use and preventative maintenance for the respective warranty period shown below. Devicor Medical Products, Inc.'s obligation under this warranty is limited to the repair or replacement, at its option, of any product, or part thereof, which has been returned to Devicor Medical Products, Inc. or its distributor within the applicable time period shown below and which examination disclosed, to Devicor Medical Products, Inc.'s satisfaction, to be defective. This warranty does not apply to any product, or part thereof, that has been: 1) adversely affected due to use with devices manufactured or distributed by parties not authorized by Devicor Medical Products, Inc. 2) repaired or altered outside Devicor Medical Products, Inc.'s factory in a way so as to, in Devicor Medical Products, Inc.'s judgment, affect its stability or reliability, 3) subjected to improper use, negligence or accident, or 4) used other than in accordance with the design and use parameters, instructions and guidelines for the product or with functional, operational or environmental standards for similar products generally accepted in the industry. Preventative maintenance should be performed by qualified service personnel and is not covered by this warranty.

Devicor Medical Products, Inc.'s products are warranted for the following periods after delivery to the original purchaser:

- ST Holster: One (1) Year, Parts and Labor
- U/S Holster: One (1) Year, Parts and Labor
- EX Holster: One (1) Year, Parts and Labor
- Control Module: One (1) Year, Parts and Labor
- Remote Footswitch: One (1) Year, Parts and Labor
- Cart: One (1) Year, Parts and Labor
- EX Holders: One (1) Year, Parts and Labor
- Remote Keypad: One (1) Year, Parts and Labor
- Software Package: One (1) Year, Parts and Labor

***UNLESS SUPERCEDED BY APPLICABLE LOCAL LAW***, THIS WARRANTY IS IN LIEU OF ALL OTHER WARRANTIES, EXPRESS OR IMPLIED, INCLUDING THE WARRANTIES ***OF*** MERCHANTABILITY AND FITNESS FOR A PARTICULAR PURPOSE, AND OF ALL OTHER OBLIGATIONS OR LIABILITIES ON THE PART OF DEVICOR MEDICAL PRODUCTS, INC. AND IS A PURCHASER'S EXCLUSIVE REMEDY. IN NO EVENT SHALL DEVICOR MEDICAL PRODUCTS, INC. BE LIABLE FOR SPECIAL, INCIDENTAL, OR CONSEQUENTIAL DAMAGES INCLUDING, WITHOUT LIMITATION, DAMAGES RESULTING FROM LOSS OF USE, PROFITS, BUSINESS, OR GOODWILL OTHER THAN AS EXPRESSLY PROVIDED BY A SPECIFIC LAW.

Devicor Medical Products, Inc. neither assumes nor authorizes any other person to assume for it, any other liability in connection with the sale or use of any of Devicor Medical Products, Inc. products. There are no warranties that extend beyond the terms herein.

Devicor Medical Products, Inc. reserves the right to make changes to products built and/or sold by them at any time without incurring any obligation to make the same or similar changes on products previously built and/or sold by them.

**PRECAUTION:** Federal (USA) law restricts this device to sale by or on the order of a physician.

## Chapter 12 STEREOTACTIC (ST) HOLSTER STATES

| State and Aperture                                                                                 | Holster only without Variable Aperture | Remote (Keypad or Footswitch) without Variable Aperture |
|----------------------------------------------------------------------------------------------------|----------------------------------------|---------------------------------------------------------|
| <ul style="list-style-type: none"> <li>• Ready</li> <li>• Closed</li> </ul>                        |                                        |                                                         |
| <ul style="list-style-type: none"> <li>• Armed</li> <li>• Closed</li> </ul>                        |                                        |                                                         |
| <ul style="list-style-type: none"> <li>• Armed, Standby</li> <li>• Closed</li> </ul>               |                                        |                                                         |
| <ul style="list-style-type: none"> <li>• Just Fired</li> <li>• Open</li> </ul>                     |                                        |                                                         |
| <ul style="list-style-type: none"> <li>• Ready</li> <li>• Open</li> </ul>                          |                                        |                                                         |
| <ul style="list-style-type: none"> <li>• Ready</li> <li>• Open</li> </ul>                          |                                        |                                                         |
| <ul style="list-style-type: none"> <li>• 12<sup>th</sup> Sample Taken</li> <li>• Closed</li> </ul> |                                        |                                                         |

| State and Aperture                                                                                 | Remote (Keypad or Footswitch) with Variable Aperture ON |                                                                                                                                |
|----------------------------------------------------------------------------------------------------|---------------------------------------------------------|--------------------------------------------------------------------------------------------------------------------------------|
| <ul style="list-style-type: none"> <li>• Ready</li> <li>• Closed</li> </ul>                        |                                                         | System cannot ARM with Variable Aperture Set. Variable Aperture can be set after the system has completed the firing sequence. |
| <ul style="list-style-type: none"> <li>• Ready</li> <li>• Open</li> </ul>                          |                                                         |                                                                                                                                |
| <ul style="list-style-type: none"> <li>• 12<sup>th</sup> Sample Taken</li> <li>• Closed</li> </ul> |                                                         |                                                                                                                                |

**REF**

**MSCM1, MSTH1, MHUSH1, MHEXH1, MCART1, MHEXHOLD1, MHKEYP1, MFOOT1, MST0809, MST0812, MST0815, MST1009, MST1012, MST1015, MHUS08, MHUS10, MHEX08, MHEX08S, MG08A, MG08B, MG10A, MG10B, MCANISTER1, MSMB1208, MSMB1210**

---

©2020 Devicor Medical Products, Inc. All rights reserved.

Mammotome and Mammotome revolve are registered trademarks of Devicor Medical Products, Inc., part of Leica Biosystems, in USA and optionally in other countries.

Bemis is a registered trademark of Bemis Manufacturing Company.



AW001413 REV C

| <b>Mammotome revolve Dual Vacuum-Assisted Biopsy System User Instructions and Operations Guide</b>                                                                                                                                                                                                                                                         |              |                 |                   |             |
|------------------------------------------------------------------------------------------------------------------------------------------------------------------------------------------------------------------------------------------------------------------------------------------------------------------------------------------------------------|--------------|-----------------|-------------------|-------------|
| Mammotome revolve User Instructions and Operations Guide (English)                                                                                                                                                                                                                                                                                         |              |                 |                   |             |
| <b>ARTWORK NUMBER</b>                                                                                                                                                                                                                                                                                                                                      | <b>SCALE</b> | <b>REVISION</b> | <b>ECN NUMBER</b> | <b>DATE</b> |
| AW-001413                                                                                                                                                                                                                                                                                                                                                  | 1:1          | C               | ECN-002017        | 04/30/2020  |
| <b>PRODUCT CODE</b>                                                                                                                                                                                                                                                                                                                                        |              |                 | <b>DRAWN BY</b>   |             |
| MSCM1, MSTH1, MHUSH1, MCART1, MHKEYP1, MFOOT1, MST0809, MST0812, MST0815, MST1009, MST1012, MST1015, MHUS08, MHUS10, MG08A, MG08B, MG10A, MG10B, MCANISTER1, MSMB1208, MSMB1210, MHEXH1, MHEX08, MHEX08S, MHEXHOLD1                                                                                                                                        |              |                 | A. Storer         |             |
|  <p><b>PROPRIETARY AND CONFIDENTIAL</b><br/> THE INFORMATION CONTAINED IN THIS DRAWING IS THE SOLE PROPERTY OF DEVICOR MEDICAL PRODUCTS, INC. ANY REPRODUCTION IN PART OR AS A WHOLE WITHOUT THE WRITTEN PERMISSION OF DEVICOR MEDICAL PRODUCTS, INC. IS PROHIBITED.</p> |              |                 |                   |             |

**Notes:**

1. Translations: English, French, German, Italian, Spanish, Portuguese, Polish, Dutch, Czechoslovakian, Slovakian, Danish, Swedish, Norwegian, Croatian, Japanese, Korean, Finnish, Greek, Slovenian
2. All translations part of this eIFU is generated as its own file.