

## Partial FCC Test Report

### (PART 24)

**Report No.:** RF190514C12-1

**FCC ID:** 2ATM8EC25A

**Test Model:** EC25-A

**Received Date:** May 14, 2019

**Test Date:** May 27 ~ May 30, 2019

**Issued Date:** Jul. 26, 2019

**Applicant:** Hawkeye Tech Co., Ltd.

**Address:** 13F. No.736, Zhongzheng Rd., Zhonghe Dist., New Taipei City 235, Taiwan

**Issued By:** Bureau Veritas Consumer Products Services (H.K.) Ltd., Taoyuan Branch

**Lab Address:** No. 47-2, 14th Ling, Chia Pau Vil., Lin Kou Dist., New Taipei City, Taiwan  
( R.O.C)

**Test Location (1):** No.19, Hwa Ya 2nd Rd., Wen Hwa Vil., Kwei Shan Dist., Taoyuan City  
33383, TAIWAN (R.O.C.)

**Test Location (2):** B2F., No.215, Sec. 3, Beixin Rd., Xindian Dist., New Taipei City 231,  
Taiwan, R.O.C

**FCC Registration /** 788550 / TW0003

**Designation Number:** 427177 / TW0011



This report is for your exclusive use. Any copying or replication of this report to or for any other person or entity, or use of our name or trademark, is permitted only with our prior written permission. This report sets forth our findings solely with respect to the test samples identified herein. The results set forth in this report are not indicative or representative of the quality or characteristics of the lot from which a test sample was taken or any similar or identical product unless specifically and expressly noted. Our report includes all of the tests requested by you and the results thereof based upon the information that you provided to us. You have 60 days from date of issuance of this report to notify us of any material error or omission caused by our negligence, provided, however, that such notice shall be in writing and shall specifically address the issue you wish to raise. A failure to raise such issue within the prescribed time shall constitute your unqualified acceptance of the completeness of this report, the tests conducted and the correctness of the report contents. Unless specific mention, the uncertainty of measurement has been explicitly taken into account to declare the compliance or non-compliance to the specification. The report must not be used by the client to claim product certification, approval, or endorsement by TAF or any government agencies.

## Table of Contents

<b>Release Control Record .....</b>	<b>3</b>
<b>1 Certificate of Conformity .....</b>	<b>4</b>
<b>2 Summary of Test Results.....</b>	<b>5</b>
2.1 Measurement Uncertainty.....	5
2.2 Test Site and Instruments .....	6
<b>3 General Information .....</b>	<b>7</b>
3.1 General Description of EUT .....	7
3.2 Configuration of System under Test.....	8
3.2.1 Description of Support Units.....	8
3.3 Test Mode Applicability and Tested Channel Detail .....	9
3.4 EUT Operating Conditions .....	10
3.5 General Description of Applied Standards.....	10
<b>4 Test Types and Results .....</b>	<b>11</b>
4.1 Output Power Measurement.....	11
4.1.1 Limits of Output Power Measurement .....	11
4.1.2 Test Procedures.....	11
4.1.3 Test Setup.....	12
4.1.4 Test Results .....	13
4.2 Radiated Emission Measurement.....	17
4.2.1 Limits of Radiated Emission Measurement .....	17
4.2.2 Test Procedure .....	17
4.2.3 Deviation from Test Standard .....	17
4.2.4 Test Setup.....	18
4.2.5 Test Results .....	19
<b>5 Pictures of Test Arrangements.....</b>	<b>43</b>
<b>Appendix – Information of the Testing Laboratories .....</b>	<b>44</b>

### Release Control Record

Issue No.	Description	Date Issued
RF190514C12-1	Original Release	Jul. 26, 2019

## 1 Certificate of Conformity

**Product:** LTE Module  
**Brand:** Quectel  
**Test Model:** EC25-A  
**Sample Status:** Engineering Sample  
**Applicant:** Hawkeye Tech Co., Ltd.  
**Test Date:** May 27 ~ May 30, 2019  
**Standards:** FCC Part 24, Subpart E

The above equipment has been tested by **Bureau Veritas Consumer Products Services (H.K.) Ltd., Taoyuan Branch**, and found compliance with the requirement of the above standards. The test record, data evaluation & Equipment Under Test (EUT) configurations represented herein are true and accurate accounts of the measurements of the sample's RF characteristics under the conditions specified in this report.

Prepared by :  , Date: Jul. 26, 2019  
Lena Wang / Specialist

Approved by :  , Date: Jul. 26, 2019  
Dylan Chiou / Project Engineer

## 2 Summary of Test Results

Applied Standard: FCC Part 24 & Part 2			
FCC Clause	Test Item	Result	Remarks
2.1046 24.232	Effective Isotropic Radiated Power	Pass	Meet the requirement of limit.
2.1047	Modulation Characteristics	N/A	Refer to Note
2.1046 24.232(d)	Peak to Average Ratio	N/A	Refer to Note
2.1055 24.235	Frequency Stability	N/A	Refer to Note
2.1049	Occupied Bandwidth	N/A	Refer to Note
24.238	Band Edge Measurements	N/A	Refer to Note
2.1051 24.238	Conducted Spurious Emissions	N/A	Refer to Note
2.1053 24.238	Radiated Spurious Emissions	Pass	Meet the requirement of limit. Minimum passing margin is -27.89 dB at 5640 MHz.

### Note:

1. This report is a partial report. Therefore, only test item of Effective Isotropic Radiated Power and Radiated Spurious Emissions tests were performed for this report. Other testing data please refer to Bay Area Compliance Laboratories Corp.(Taiwan) report no.: RTWK160705001-00 for module (Brand: Quectel, Model: EC25-A)
2. Determining compliance based on the results of the compliance measurement, not taking into account measurement instrumentation uncertainty.

### 2.1 Measurement Uncertainty

Where relevant, the following measurement uncertainty levels have been estimated for tests performed on the EUT as specified in CISPR 16-4-2:

Measurement	Frequency	Expanded Uncertainty (k=2) (±)
Radiated Emissions up to 1 GHz	9 kHz ~ 30 MHz	3.0400 dB
	30 MHz ~ 200 MHz	2.0153 dB
	200 MHz ~ 1000 MHz	2.0224 dB
Radiated Emissions above 1 GHz	1 GHz ~ 18 GHz	1.0121 dB
	18 GHz ~ 40 GHz	1.1508 dB

## 2.2 Test Site and Instruments

Description & Manufacturer	Model No.	Serial No.	Date of Calibration	Due Date of Calibration
Test Receiver Agilent Technologies	N9038A	MY52260177	Aug. 20, 2018	Aug. 19, 2019
BILOG Antenna SCHWARZBECK	VULB9168	9168-616	Nov. 27, 2018	Nov. 26, 2019
HORN Antenna ETS-Lindgren	3117	00143293	Nov. 25, 2018	Nov. 24, 2019
HORN Antenna SCHWARZBECK	BBHA9170	9170-480	Nov. 25, 2018	Nov. 24, 2019
HORN Antenna SCHWARZBECK	BBHA 9120D	9120D-969	Nov. 25, 2018	Nov. 24, 2019
Fixed Attenuator Mini-Circuits	MDCS18N-10	MDCS18N-10-01	Apr. 15, 2019	Apr. 14, 2020
MXG Vector signal generator Agilent	N5182B	MY53050430	Nov. 19, 2018	Nov. 18, 2019
Preamplifier Agilent	310N	187226	Jun. 19, 2018	Jun. 18, 2019
Preamplifier Agilent	83017A	MY39501357	Jun. 19, 2018	Jun. 18, 2019
RF signal cable ETS-LINDGREN	5D-FB	Cable-CH1-01(RFC-SMS-100-SMS-120+RFC-SMS-100-SMS-400)	Jun. 19, 2018	Jun. 18, 2019
RF signal cable ETS-LINDGREN	8D-FB	Cable-CH1-02(RFC-SMS-100-SMS-24)	Jun. 19, 2018	Jun. 18, 2019
Boresight Antenna Fixture	FBA-01	FBA-SIP01	NA	NA
Software BV ADT	E3 8.130425b	NA	NA	NA
Antenna Tower MF	NA	NA	NA	NA
Turn Table MF	NA	NA	NA	NA
Antenna Tower & Turn Table Controller MF	MF-7802	NA	NA	NA
Communications Tester- Wireless Agilent	8960 Series 10	MY53201073	Jun. 28, 2017	Jun. 27, 2019
Radio Communication Analyzer Anritsu	MT8820C	6201300640	Aug. 16, 2017	Aug. 15, 2019

Note: 1. The calibration interval of the above test instruments is 12 / 24 months and the calibrations are traceable to NML/ROC and NIST/USA.

2. The test was performed in HsinTien Chamber 1.

### 3 General Information

#### 3.1 General Description of EUT

<b>Product</b>	LTE Module	
<b>Brand</b>	Quectel	
<b>Test Model</b>	EC25-A	
<b>Status of EUT</b>	Engineering Sample	
<b>Power Supply Rating</b>	3.8 Vdc (Host equipment)	
<b>Modulation Type</b>	WCDMA	QPSK
	LTE	QPSK, 16QAM
<b>Frequency Range</b>	WCDMA	1852.4 ~ 1907.6 MHz
	LTE Band 2 (Channel Bandwidth: 1.4 MHz)	1850.7 ~ 1909.3 MHz
	LTE Band 2 (Channel Bandwidth: 3 MHz)	1851.5 ~ 1908.5 MHz
	LTE Band 2 (Channel Bandwidth: 5 MHz)	1852.5 ~ 1907.5 MHz
	LTE Band 2 (Channel Bandwidth: 10 MHz)	1855.0 ~ 1905.0 MHz
	LTE Band 2 (Channel Bandwidth: 15 MHz)	1857.5 ~ 1902.5 MHz
	LTE Band 2 (Channel Bandwidth: 20 MHz)	1860.0 ~ 1900.0 MHz
<b>Max. EIRP Power</b>	WCDMA	115.88 mW
	LTE Band 2 (Channel Bandwidth: 1.4 MHz)	111.94 mW
	LTE Band 2 (Channel Bandwidth: 3 MHz)	112.72 mW
	LTE Band 2 (Channel Bandwidth: 5 MHz)	113.76 mW
	LTE Band 2 (Channel Bandwidth: 10 MHz)	114.82 mW
	LTE Band 2 (Channel Bandwidth: 15 MHz)	115.88 mW
	LTE Band 2 (Channel Bandwidth: 20 MHz)	116.68 mW
<b>Antenna Type</b>	Dipole Antenna with 1.5 dBi gain	
<b>Accessory Device</b>	N/A	
<b>Data Cable Supplied</b>	N/A	

Note:

- The EUT was installed in a specific End-product.

Product	Brand	Model	FCC ID
veeaHub		VHE10XXX (X=A-Z, 0-9, blank or "-")	2ARXKVHE10

- The End-product contains following accessory devices.

Product	Brand	Model	Description
AC Adapter	EDACPOWER ELEC.	EA1062SGR-480	I/P: 100-240 Vac, 50/60 Hz, 2.5 A O/P: 48 Vdc, 1.35 A 1.2m DC cable with 1 core

- The above EUT information is declared by manufacturer and for more detailed features description, please refers to the manufacturer's specifications or user's manual.

### 3.2 Configuration of System under Test

#### <Radiated Emission Test> & <E.I.R.P. Test>

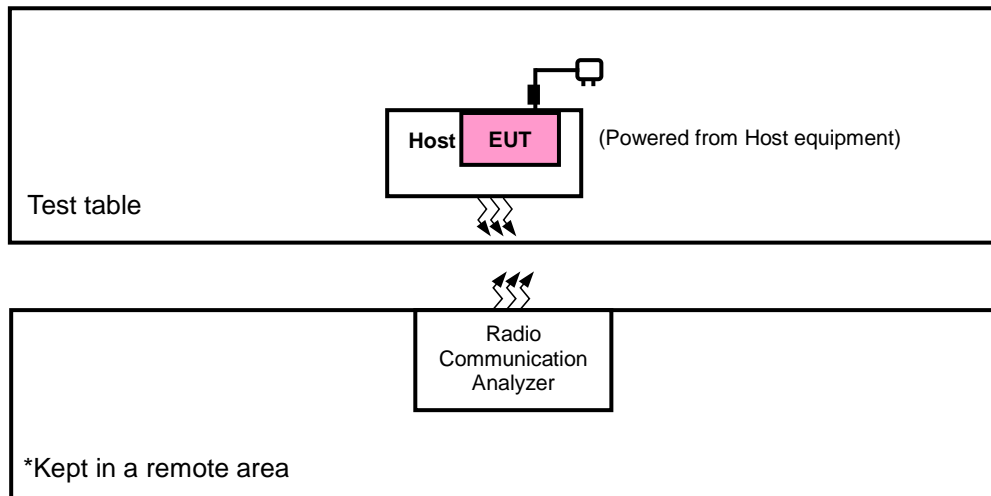

#### 3.2.1 Description of Support Units

The EUT has been tested as an independent unit together with other necessary accessories or support units.



### 3.3 Test Mode Applicability and Tested Channel Detail

Pre-Scan has been conducted to determine the worst-case mode from all possible combinations between available modulations, data rates, antenna degree 90° and 180°, and antenna ports.

The worst case was found when positioned as the table below. Following channel(s) was (were) selected for the final test as listed below:

Band	EIRP	Radiated Emission
WCDMA	90°	90°
LTE Band 2	90°	90°

#### WCDMA

EUT Configure Mode	Test Item	Available Channel	Tested Channel	Mode
-	EIRP	9262 to 9538	9262, 9400, 9538	WCDMA
-	Radiated Emission	9262 to 9538	9262, 9400, 9538	WCDMA

#### LTE Band 2

EUT Configure Mode	Test Item	Available Channel	Tested Channel	Channel Bandwidth	Modulation	Mode
-	EIRP	18607 to 19193	18607, 18900, 19193	1.4 MHz	QPSK, 16QAM	1 RB / 0 RB Offset
		18615 to 19185	18615, 18900, 19185	3 MHz	QPSK, 16QAM	1 RB / 0 RB Offset
		18625 to 19175	18625, 18900, 19175	5 MHz	QPSK, 16QAM	1 RB / 0 RB Offset
		18650 to 19150	18650, 18900, 19150	10 MHz	QPSK, 16QAM	1 RB / 0 RB Offset
		18675 to 19125	18675, 18900, 19125	15 MHz	QPSK, 16QAM	1 RB / 0 RB Offset
		18700 to 19100	18700, 18900, 19100	20 MHz	QPSK, 16QAM	1 RB / 0 RB Offset
-	Radiated Emission	18607 to 19193	18607, 18900, 19193	1.4 MHz	QPSK	1 RB / 0 RB Offset
		18625 to 19175	18625, 18900, 19175	5 MHz	QPSK	1 RB / 0 RB Offset
		18700 to 19100	18700, 18900, 19100	20 MHz	QPSK	1 RB / 0 RB Offset

#### Note:

1. This device was tested under all bandwidths, RB configurations and modulations. The worst case was found in QPSK modulation and RB configurations according to Module report worst maximum output power.
2. For radiated emission, according to 3GPP 36.521 Section 6.6.3.1.4, choose the lowest, 5 MHz & highest channel bandwidth for final test.

#### Test Condition:

Test Item	Environmental Conditions	Input Power	Tested By
EIRP	26 deg. C, 58 % RH	3.8 Vdc	Karl Lee
Radiated Emission	25 deg. C, 65 % RH	120 Vac, 60 Hz	Karl Lee

### **3.4 EUT Operating Conditions**

The EUT makes a call to the communication simulator. The communication simulator station system controlled a EUT to export maximum output power under transmission mode and specific channel frequency

### **3.5 General Description of Applied Standards**

The EUT is a RF Product. According to the specifications of the manufacturer, it must comply with the requirements of the following standards:

**FCC 47 CFR Part 2**

**FCC 47 CFR Part 24**

**KDB 971168 D01 Power Meas License Digital Systems v03r01**

**ANSI/TIA/EIA-603-E 2016**

**ANSI 63.26-2015**

**ANSI 63.2 -1996**

**NOTE:** All test items have been performed and recorded as per the above standards.

## 4 Test Types and Results

### 4.1 Output Power Measurement

#### 4.1.1 Limits of Output Power Measurement

Mobile / Portable station are limited to 2 watts e.i.r.p.

#### 4.1.2 Test Procedures

##### **EIRP / ERP Measurement:**

- a. All measurements were done at low, middle and high operational frequency range. RBW and VBW is 5 MHz for WCDMA and 10 MHz for LTE mode.
- b. Substitution method is used for E.I.R.P measurement. In the semi-anechoic chamber, EUT placed on the 0.8 m (below or equal 1 GHz) and/or 1.5 m (above 1 GHz) height of Turn Table, rotated the table around 360 degrees to search the maximum radiation power and receiver antenna shall be rotated vertical and horizontal polarization and moved height from 1 m to 4 m to find the maximum polar radiated power. The "Read Value" is the spectrum reading the maximum power value.
- c. The substitution horn antenna is substituted for EUT at the same position and signals generator export the CW signal to the substitution antenna via a tx cable. Rotated the Turn Table and moved receiving antenna to find the maximum radiation power. Adjust output power level of S.G to get a Value of spectrum reading equal to "Read Value" of step b. Record the power level of S.G.
- d.  $EIRP = \text{Output power level of S.G} - \text{TX cable loss} + \text{Antenna gain of substitution horn}$ . E.R.P power can be calculated form E.I.R.P power by subtracting the gain of dipole,  $E.R.P \text{ power} = E.I.R.P \text{ power} - 2.15 \text{ dB}$ .

##### **Conducted Power Measurement:**

The EUT was set up for the maximum power with WCDMA and LTE link data modulation and link up with simulator. Set the EUT to transmit under low, middle and high channel and record the power level shown on simulator.

4.1.3 Test Setup

**EIRP / ERP Measurement:**

**<Radiated Emission below or equal 1 GHz>**

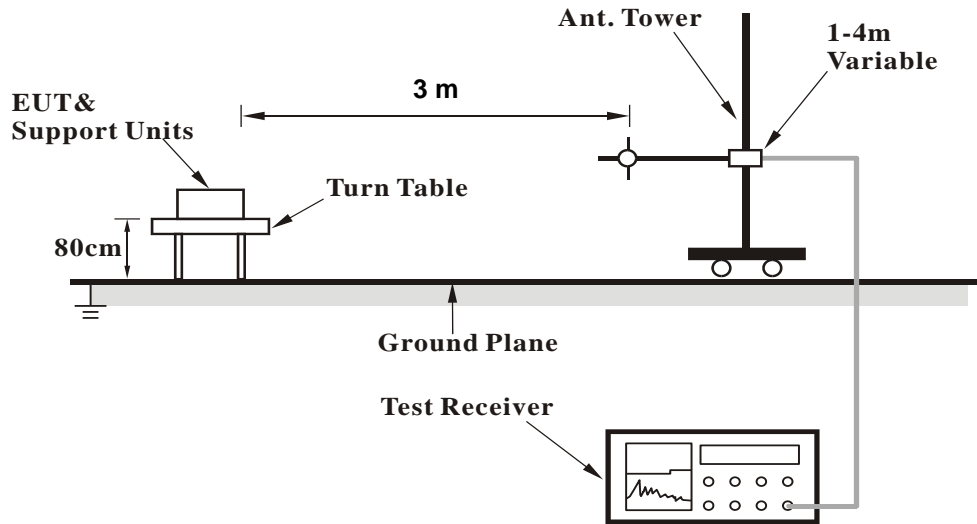

**<Radiated Emission above 1 GHz>**

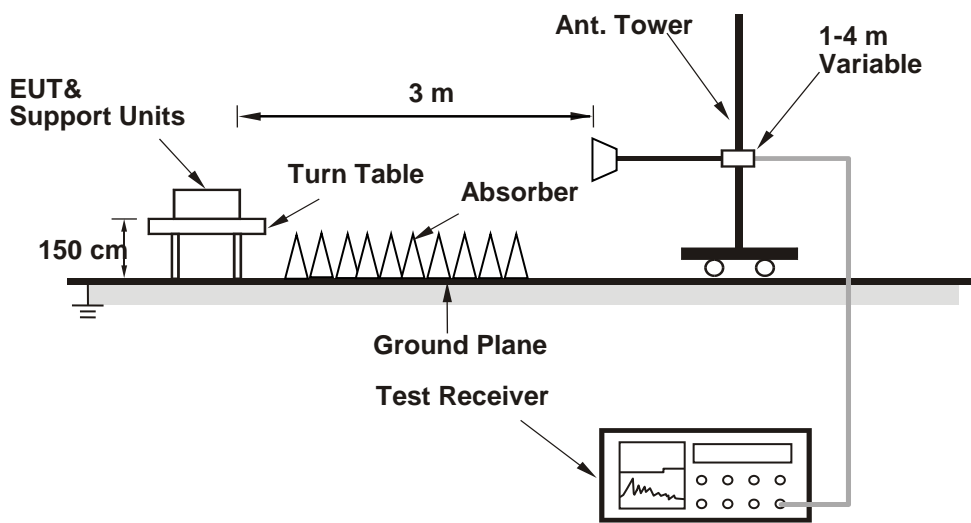

For the actual test configuration, please refer to the attached file (Test Setup Photo).

**Conducted Power Measurement:**

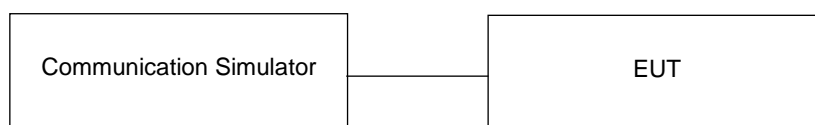

4.1.4 Test Results

**EIRP Power (dBm)**

WCDMA							
Plane	Channel	Frequency (MHz)	Reading (dBm)	Correction Factor (dB)	EIRP (dBm)	EIRP (mW)	Polarization (H/V)
90°	9262	1852.4	-17.60	38.19	20.59	114.55	H
	9400	1880.0	-18.06	38.70	20.64	115.88	
	9538	1907.6	-18.80	39.35	20.55	113.50	
	9262	1852.4	-21.87	38.48	16.61	45.81	V
	9400	1880.0	-21.92	38.59	16.67	46.45	
	9538	1907.6	-22.36	38.87	16.51	44.77	

Note: EIRP (dBm) = Reading (dBm) + Correction Factor (dB)

LTE Band 2							
Channel Bandwidth: 1.4 MHz / QPSK							
Plane	Channel	Frequency (MHz)	Reading (dBm)	Correction Factor (dB)	EIRP (dBm)	EIRP (mW)	Polarization (H/V)
90°	18607	1850.7	-24.21	44.70	20.49	111.94	H
	18900	1880.0	-24.33	44.70	20.37	108.89	
	19193	1909.3	-24.13	44.57	20.44	110.74	
	18607	1850.7	-27.76	44.27	16.51	44.77	V
	18900	1880.0	-28.52	44.87	16.35	43.15	
	19193	1909.3	-28.19	44.61	16.42	43.88	
Channel Bandwidth: 1.4 MHz / 16QAM							
90°	18607	1850.7	-25.22	44.70	19.48	88.72	H
	18900	1880.0	-25.34	44.70	19.36	86.30	
	19193	1909.3	-25.13	44.57	19.44	87.96	
	18607	1850.7	-28.77	44.27	15.50	35.48	V
	18900	1880.0	-29.52	44.87	15.35	34.28	
	19193	1909.3	-29.20	44.61	15.41	34.78	

Note: EIRP (dBm) = Reading (dBm) + Correction Factor (dB)

LTE Band 2							
Channel Bandwidth: 3 MHz / QPSK							
Plane	Channel	Frequency (MHz)	Reading (dBm)	Correction Factor (dB)	EIRP (dBm)	EIRP (mW)	Polarization (H/V)
90°	18615	1851.5	-24.18	44.70	20.52	112.72	H
	18900	1880.0	-24.30	44.70	20.40	109.65	
	19185	1908.5	-24.09	44.57	20.48	111.76	
	18615	1851.5	-27.72	44.27	16.55	45.19	V
	18900	1880.0	-28.48	44.87	16.39	43.55	
	19185	1908.5	-28.15	44.61	16.46	44.29	
Channel Bandwidth: 3 MHz / 16QAM							
90°	18615	1851.5	-25.19	44.70	19.51	89.33	H
	18900	1880.0	-25.31	44.70	19.39	86.90	
	19185	1908.5	-25.10	44.57	19.47	88.57	
	18615	1851.5	-28.72	44.27	15.55	35.89	V
	18900	1880.0	-29.49	44.87	15.38	34.51	
	19185	1908.5	-29.16	44.61	15.45	35.10	

Note: EIRP (dBm) = Reading (dBm) + Correction Factor (dB)

LTE Band 2							
Channel Bandwidth: 5 MHz / QPSK							
Plane	Channel	Frequency (MHz)	Reading (dBm)	Correction Factor (dB)	EIRP (dBm)	EIRP (mW)	Polarization (H/V)
90°	18625	1852.5	-24.14	44.70	20.56	113.76	H
	18900	1880.0	-24.27	44.70	20.43	110.41	
	19175	1907.5	-24.05	44.57	20.52	112.80	
	18625	1852.5	-27.68	44.27	16.59	45.60	V
	18900	1880.0	-28.44	44.87	16.43	43.95	
	19175	1907.5	-28.11	44.61	16.50	44.70	
Channel Bandwidth: 5 MHz / 16QAM							
90°	18625	1852.5	-25.14	44.70	19.56	90.36	H
	18900	1880.0	-25.27	44.70	19.43	87.70	
	19175	1907.5	-25.06	44.57	19.51	89.39	
	18625	1852.5	-28.69	44.27	15.58	36.14	V
	18900	1880.0	-29.45	44.87	15.42	34.83	
	19175	1907.5	-29.11	44.61	15.50	35.51	

Note: EIRP (dBm) = Reading (dBm) + Correction Factor (dB)

LTE Band 2							
Channel Bandwidth: 10 MHz / QPSK							
Plane	Channel	Frequency (MHz)	Reading (dBm)	Correction Factor (dB)	EIRP (dBm)	EIRP (mW)	Polarization (H/V)
90°	18650	1855.0	-24.10	44.70	20.60	114.82	H
	18900	1880.0	-24.23	44.70	20.47	111.43	
	19150	1905.0	-24.00	44.57	20.57	114.10	
	18650	1855.0	-27.64	44.27	16.63	46.03	V
	18900	1880.0	-28.40	44.87	16.47	44.36	
	19150	1905.0	-28.07	44.61	16.54	45.11	
Channel Bandwidth: 10 MHz / 16QAM							
90°	18650	1855.0	-25.11	44.70	19.59	90.99	H
	18900	1880.0	-25.23	44.70	19.47	88.51	
	19150	1905.0	-25.00	44.57	19.57	90.64	
	18650	1855.0	-28.65	44.27	15.62	36.48	V
	18900	1880.0	-29.41	44.87	15.46	35.16	
	19150	1905.0	-29.07	44.61	15.54	35.83	

Note: EIRP (dBm) = Reading (dBm) + Correction Factor (dB)

LTE Band 2							
Channel Bandwidth: 15 MHz / QPSK							
Plane	Channel	Frequency (MHz)	Reading (dBm)	Correction Factor (dB)	EIRP (dBm)	EIRP (mW)	Polarization (H/V)
90°	18675	1857.5	-24.06	44.70	20.64	115.88	H
	18900	1880.0	-24.20	44.70	20.50	112.20	
	19125	1902.5	-23.96	44.57	20.61	115.16	
	18675	1857.5	-27.60	44.27	16.67	46.45	V
	18900	1880.0	-28.36	44.87	16.51	44.77	
	19125	1902.5	-28.03	44.61	16.58	45.50	
Channel Bandwidth: 15 MHz / 16QAM							
90°	18675	1857.5	-25.07	44.70	19.63	91.83	H
	18900	1880.0	-25.21	44.70	19.49	88.92	
	19125	1902.5	-24.97	44.57	19.60	91.26	
	18675	1857.5	-28.61	44.27	15.66	36.81	V
	18900	1880.0	-29.37	44.87	15.50	35.48	
	19125	1902.5	-29.04	44.61	15.57	36.08	

Note: EIRP (dBm) = Reading (dBm) + Correction Factor (dB)

LTE Band 2							
Channel Bandwidth: 20 MHz / QPSK							
Plane	Channel	Frequency (MHz)	Reading (dBm)	Correction Factor (dB)	EIRP (dBm)	EIRP (mW)	Polarization (H/V)
90°	18700	1860.0	-24.03	44.70	20.67	116.68	H
	18900	1880.0	-24.16	44.70	20.54	113.24	
	19100	1900.0	-23.92	44.57	20.65	116.23	
	18700	1860.0	-27.56	44.27	16.71	46.88	V
	18900	1880.0	-28.32	44.87	16.55	45.19	
	19100	1900.0	-27.99	44.61	16.62	45.95	
Channel Bandwidth: 20 MHz / 16QAM							
90°	18700	1860.0	-25.04	44.70	19.66	92.47	H
	18900	1880.0	-25.16	44.70	19.54	89.95	
	19100	1900.0	-24.93	44.57	19.64	92.11	
	18700	1860.0	-28.56	44.27	15.71	37.24	V
	18900	1880.0	-29.33	44.87	15.54	35.81	
	19100	1900.0	-28.99	44.61	15.62	36.50	

Note: EIRP (dBm) = Reading (dBm) + Correction Factor (dB)



## 4.2 Radiated Emission Measurement

### 4.2.1 Limits of Radiated Emission Measurement

The power of any emission outside of the authorized operating frequency ranges must be attenuated below the transmitting power (P) by a factor of at least  $43 + 10 \log(P)$  dB. The emission limit is equal to -13 dBm.

### 4.2.2 Test Procedure

- a. Substitution method is used for E.I.R.P measurement. In the semi-anechoic chamber, EUT placed on the 0.8 m (below or equal 1 GHz) and/or 1.5 m (above 1 GHz) height of Turn Table, rotated the table around 360 degrees to search the maximum radiation power and receiver antenna shall be rotated vertical and horizontal polarization and moved height from 1 m to 4 m to find the maximum polar radiated power. The "Read Value" is the spectrum reading the maximum power value.
- b. The substitution horn antenna is substituted for EUT at the same position and signals generator export the CW signal to the substitution antenna via a TX cable. Rotated the Turn Table and moved receiving antenna to find the maximum radiation power. Adjust output power level of S.G to get a Value of spectrum reading equal to "Read Value" of step a. Record the power level of S.G.
- c. EIRP = Output power level of S.G – TX cable loss + Antenna gain of substitution horn.
- d. E.R.P power can be calculated form E.I.R.P power by subtracting the gain of dipole, E.R.P power = E.I.R.P power - 2.15 dB.

**NOTE:** The resolution bandwidth and video bandwidth of test receiver/spectrum analyzer is 1 MHz/3 MHz.

### 4.2.3 Deviation from Test Standard

No deviation.

#### 4.2.4 Test Setup

##### <Radiated Emission below or equal 1 GHz>

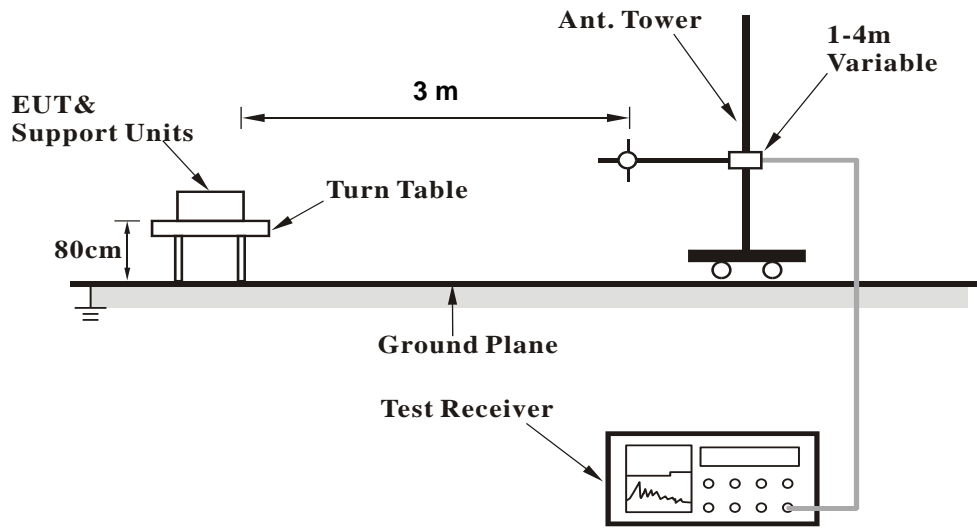

##### <Radiated Emission above 1 GHz>

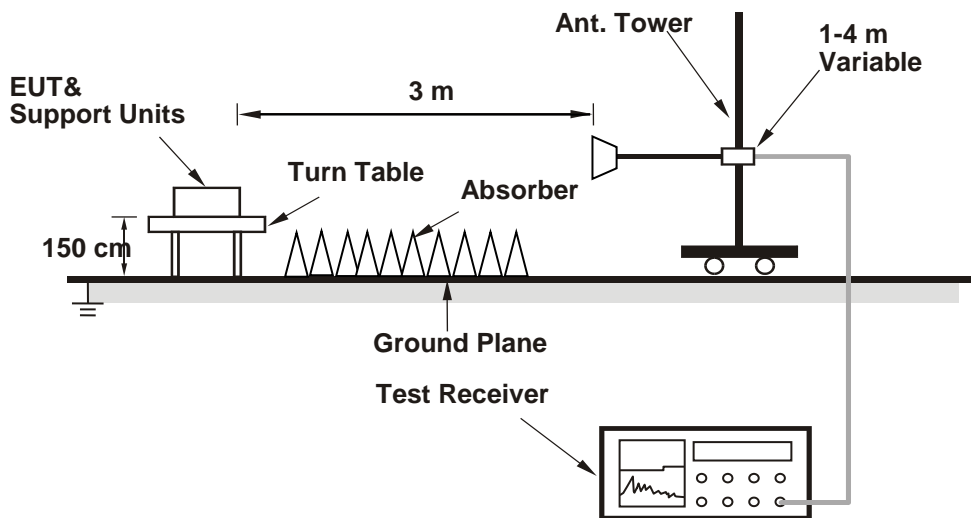

For the actual test configuration, please refer to the attached file (Test Setup Photo).

4.2.5 Test Results

WCDMA:

Low Channel



Bureau Veritas Consumer Products Services Ltd., Taoyuan Branch

A D T

Data: 9

Date: 2019-05-28

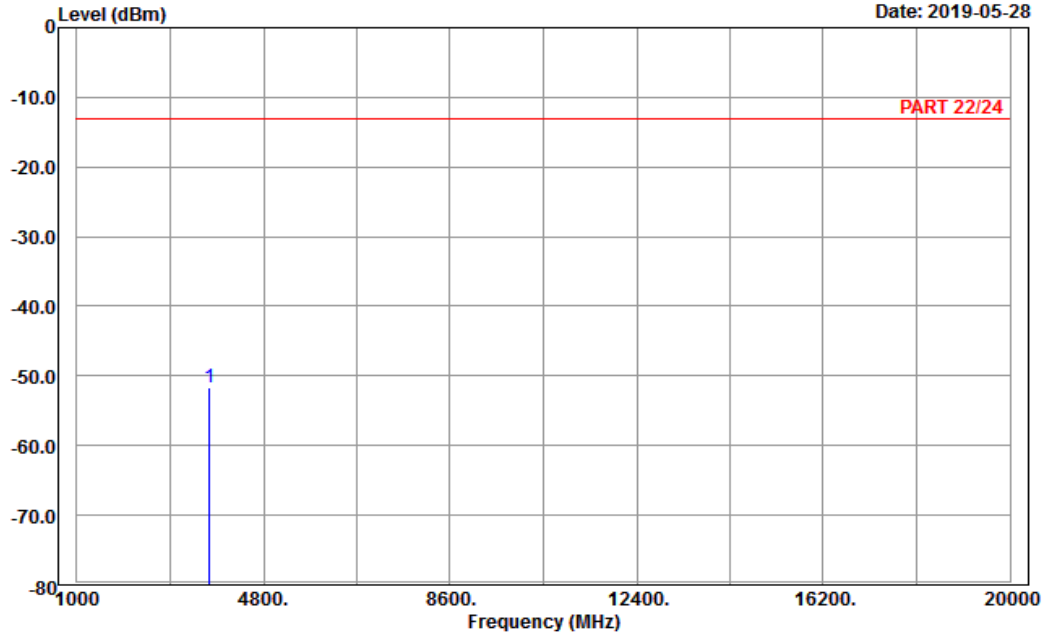

Site : 966 chamber 1  
 Condition: PART 22/24 Horizontal  
 Remark : Band II\_Link\_CH9262  
 Tested by: Karl Lee

	Freq	Level	Read Level	Factor	Limit Line	Over Limit	Remark
	MHz	dBm	dBm	dB	dBm	dB	
1 pp	3704.80	-51.56	-67.44	15.88	-13.00	-38.56	Peak



Bureau Veritas Consumer Products Services Ltd., Taoyuan Branch

A D T

Data: 10

Date: 2019-05-28

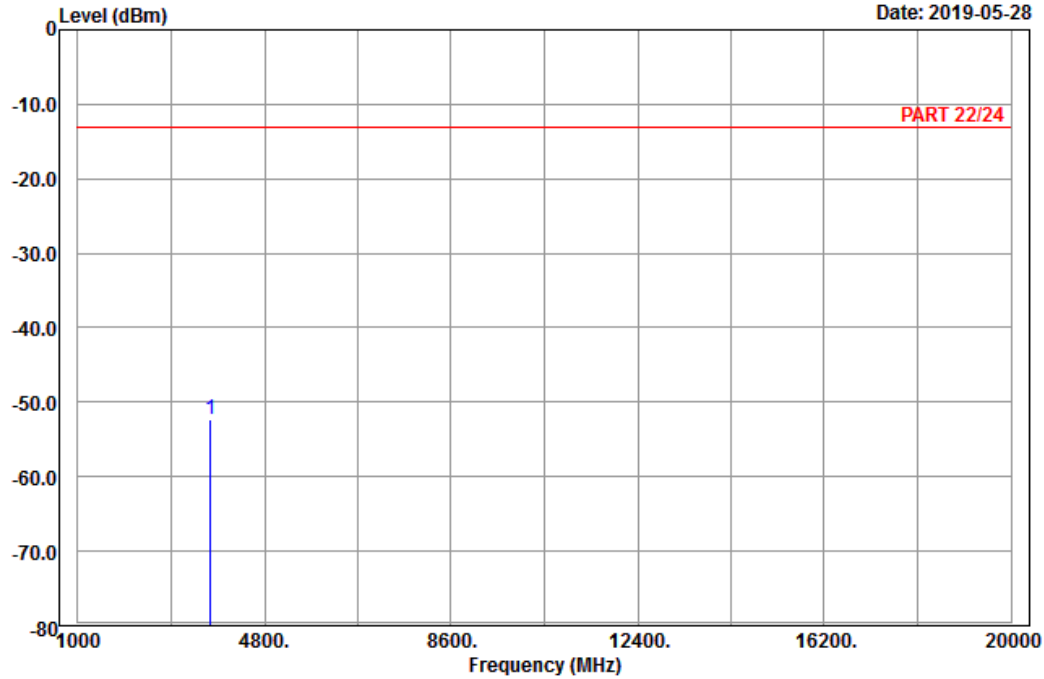

Site : 966 chamber 1  
 Condition: PART 22/24 Vertical  
 Remark : Band II\_Link\_CH9262  
 Tested by: Karl Lee

	Freq	Level	Read Level	Factor	Limit Line	Over Limit	Remark
	MHz	dBm	dBm	dB	dBm	dB	
1 pp	3704.80	-52.35	-68.23	15.88	-13.00	-39.35	Peak

Middle Channel



Bureau Veritas Consumer Products Services Ltd., Taoyuan Branch

A D T

Data: 13

Date: 2019-05-28

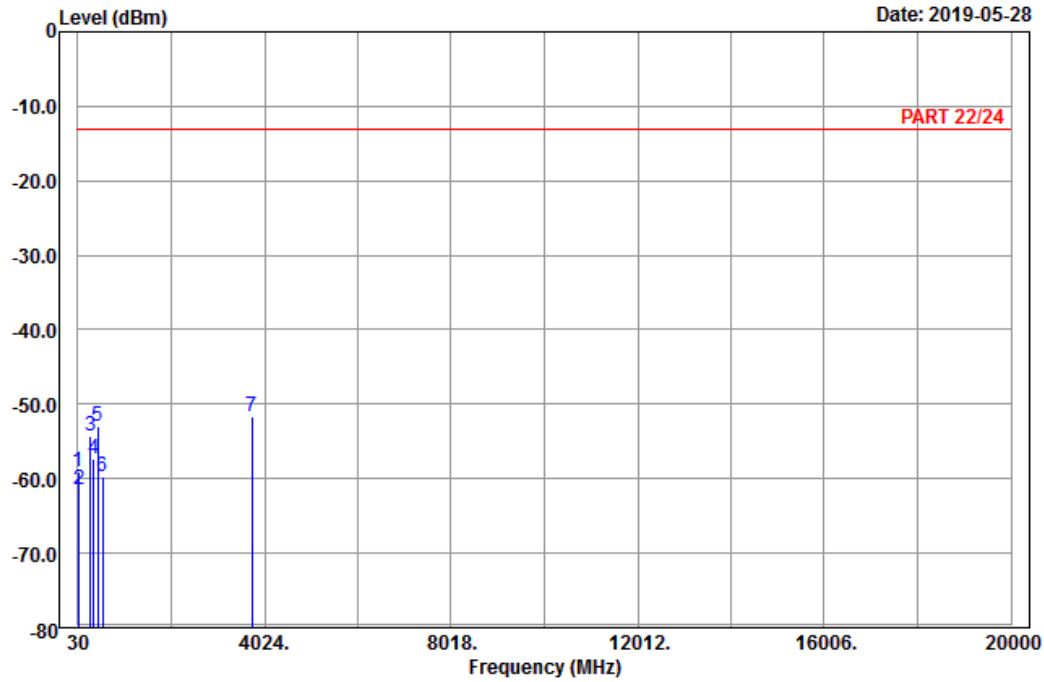

Site : 966 chamber 1  
 Condition: PART 22/24 Horizontal  
 Remark : Band II\_Link\_CH9400  
 Tested by: Karl Lee

	Freq	Level	Read Level	Factor	Limit Line	Over Limit	Remark
	MHz	dBm	dBm	dB	dBm	dB	
1	32.97	-59.04	-48.17	-10.87	-13.00	-46.04	Peak
2	59.16	-61.52	-47.46	-14.06	-13.00	-48.52	Peak
3	300.00	-54.32	-48.36	-5.96	-13.00	-41.32	Peak
4	371.40	-57.26	-53.02	-4.24	-13.00	-44.26	Peak
5	452.60	-52.94	-49.01	-3.93	-13.00	-39.94	Peak
6	568.10	-59.73	-58.83	-0.90	-13.00	-46.73	Peak
7 pp	3760.00	-51.67	-67.81	16.14	-13.00	-38.67	Peak



Bureau Veritas Consumer Products Services Ltd., Taoyuan Branch

A D T

Data: 14

Date: 2019-05-28

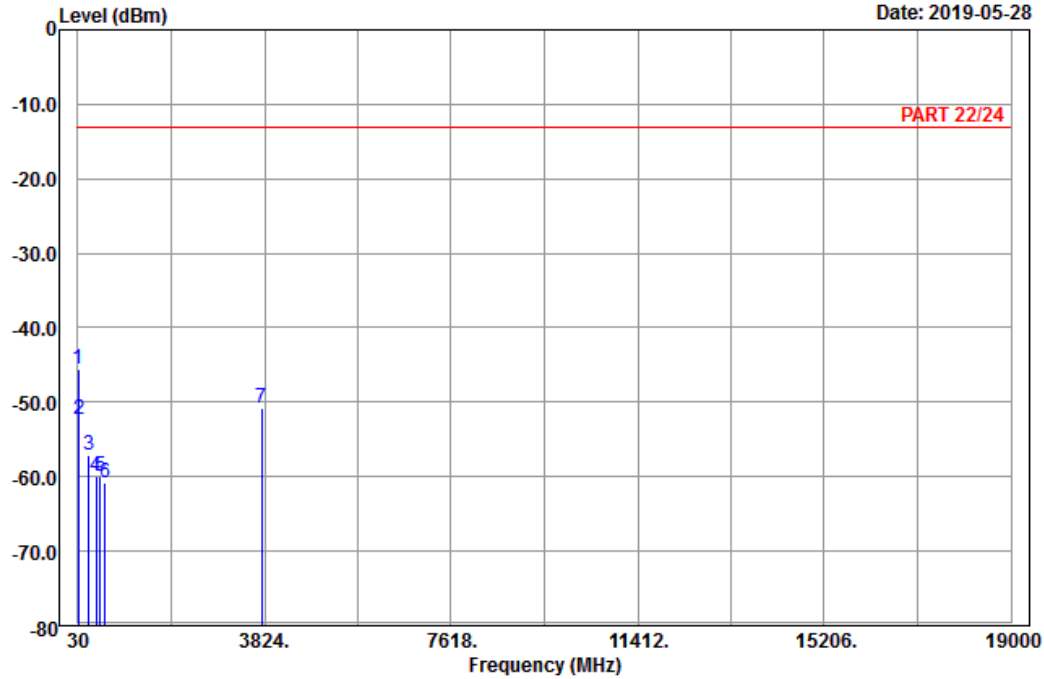

Site : 966 chamber 1  
 Condition: PART 22/24 Vertical  
 Remark : Band II\_Link\_CH9400  
 Tested by: Karl Lee

	Freq	Level	Read Level	Factor	Limit Line	Over Limit	Remark
	MHz	dBm	dBm	dB	dBm	dB	
1 pp	34.05	-45.54	-34.56	-10.98	-13.00	-32.54	Peak
2	60.78	-52.29	-38.36	-13.93	-13.00	-39.29	Peak
3	249.24	-57.21	-51.69	-5.52	-13.00	-44.21	Peak
4	407.10	-59.86	-56.95	-2.91	-13.00	-46.86	Peak
5	477.10	-60.05	-55.43	-4.62	-13.00	-47.05	Peak
6	583.50	-60.87	-60.61	-0.26	-13.00	-47.87	Peak
7	3760.00	-50.78	-66.92	16.14	-13.00	-37.78	Peak

High Channel



Bureau Veritas Consumer Products Services Ltd., Taoyuan Branch

A D T

Data: 9

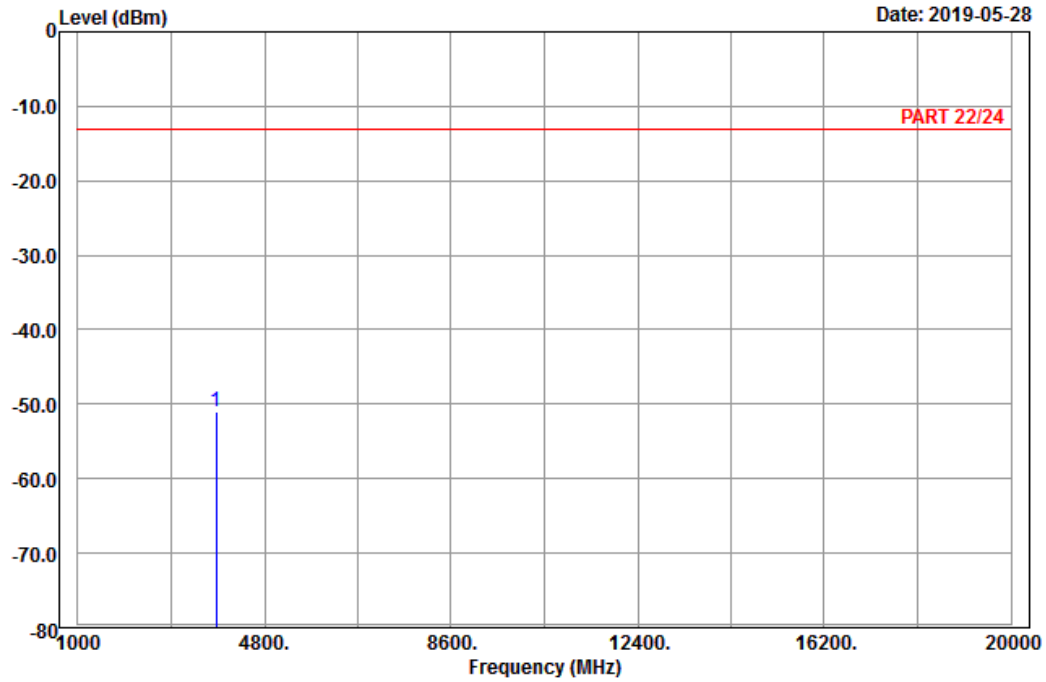

Site : 966 chamber 1  
 Condition: PART 22/24 Horizontal  
 Remark : Band II\_Link\_CH9538  
 Tested by: Karl Lee

Freq	Level	Read Level	Factor	Limit Line	Over Limit	Remark
MHz	dBm	dBm	dB	dBm	dB	
1 pp 3815.20	-51.11	-67.52	16.41	-13.00	-38.11	Peak



Bureau Veritas Consumer Products Services Ltd., Taoyuan Branch

A D T

Data: 10

Date: 2019-05-28

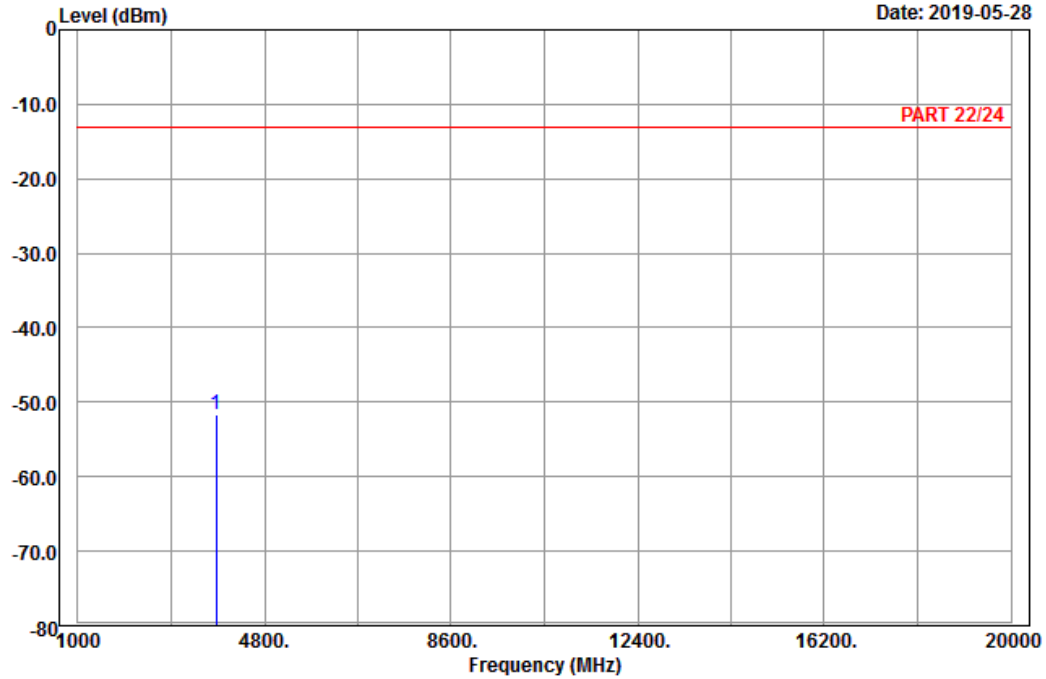

Site : 966 chamber 1  
 Condition: PART 22/24 Vertical  
 Remark : Band II\_Link\_CH9538  
 Tested by: Karl Lee

	Freq	Level	Read Level	Factor	Limit Line	Over Limit	Remark
	MHz	dBm	dBm	dB	dBm	dB	
1 pp	3815.20	-51.62	-68.03	16.41	-13.00	-38.62	Peak



LTE Band 2  
 Channel Bandwidth: 1.4 MHz / QPSK  
 Low Channel



Bureau Veritas Consumer Products Services Ltd., Taoyuan Branch

A D T

Data: 9

Date: 2019-05-27

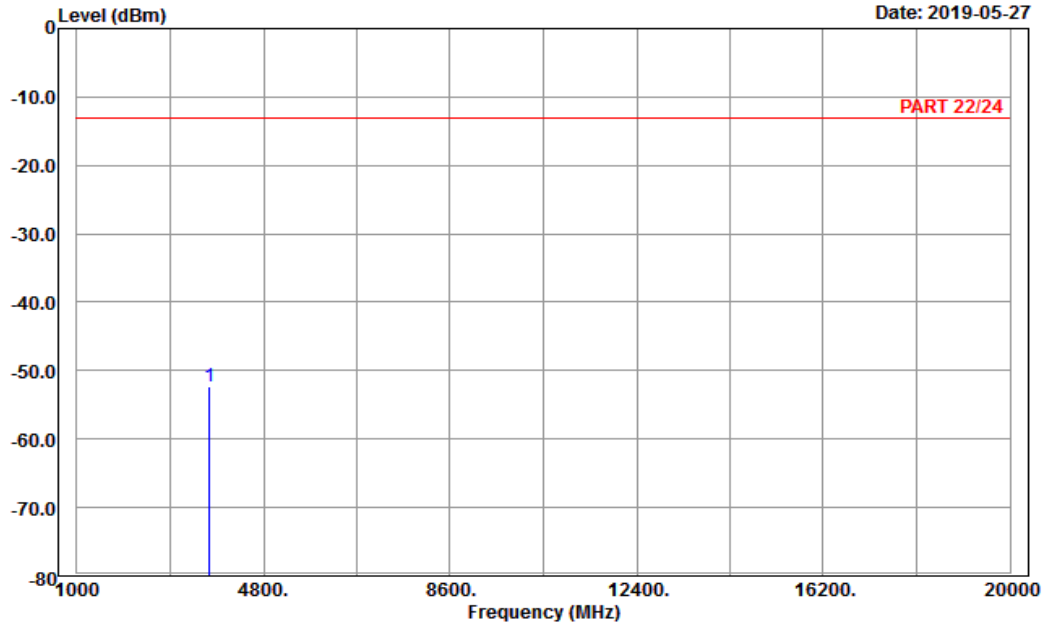

Site : 966 chamber 1  
 Condition: PART 22/24 Horizontal  
 Remark : LTE\_Band 2\_Link\_CH18607  
 Tested by: Karl Lee

	Freq	Level	Read Level	Factor	Limit	Over	Remark
	MHz	dBm	dBm	dB	dBm	dB	
1	pp	3701.40	-52.36	-68.24	15.88	-13.00	-39.36 Peak



Bureau Veritas Consumer Products Services Ltd., Taoyuan Branch

A D T

Data: 10

Date: 2019-05-27

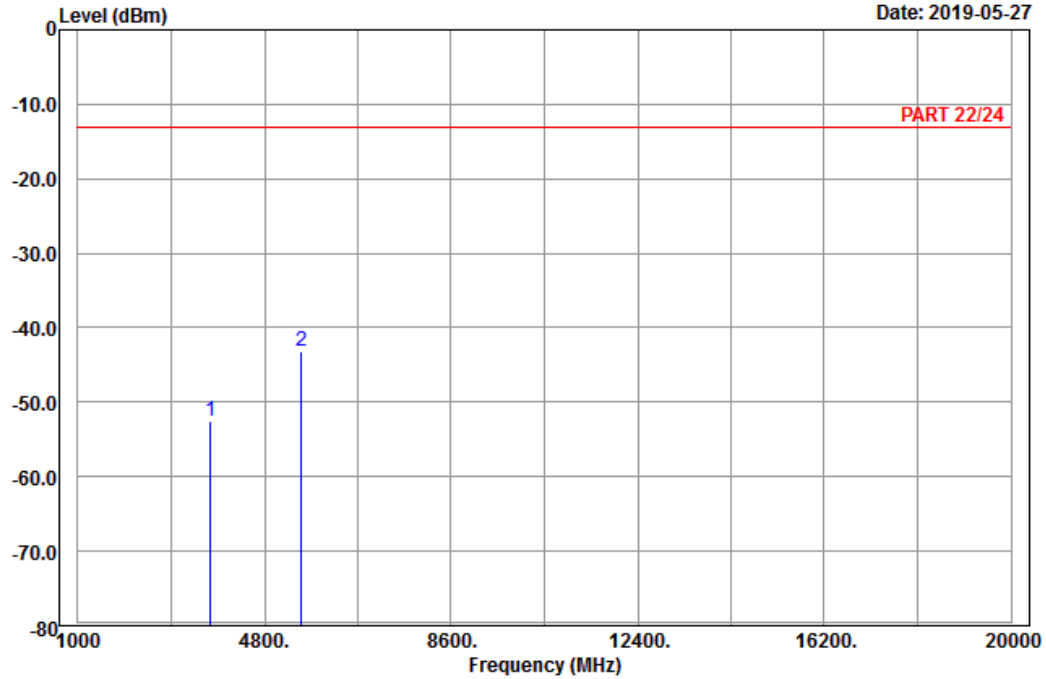

Site : 966 chamber 1  
 Condition: PART 22/24 Vertical  
 Remark : LTE\_Band 2\_Link\_CH18607  
 Tested by: Karl Lee

	Freq	Level	Read Level	Factor	Limit Line	Over Limit	Remark
	MHz	dBm	dBm	dB	dBm	dB	
1	3701.40	-52.53	-68.41	15.88	-13.00	-39.53	Peak
2 pp	5552.10	-43.26	-63.60	20.34	-13.00	-30.26	Peak

Middle Channel



Bureau Veritas Consumer Products Services Ltd., Taoyuan Branch

A D T

Data: 9

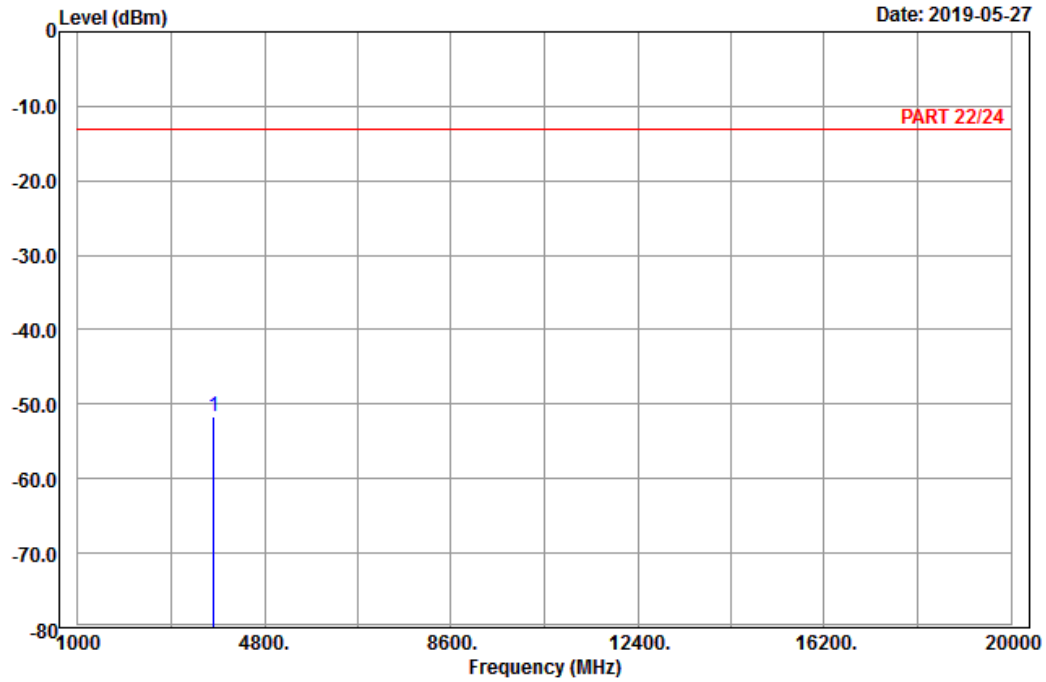

Site : 966 chamber 1  
 Condition: PART 22/24 Horizontal  
 Remark : LTE\_Band 2\_Link\_CH18900  
 Tested by: Karl Lee

Freq	Level	Read Level	Limit Factor	Limit Line	Over Limit	Remark
MHz	dBm	dBm	dB	dBm	dB	
1 pp 3760.00	-51.74	-67.88	16.14	-13.00	-38.74	Peak



Bureau Veritas Consumer Products Services Ltd., Taoyuan Branch

A D T

Data: 10

Date: 2019-05-27

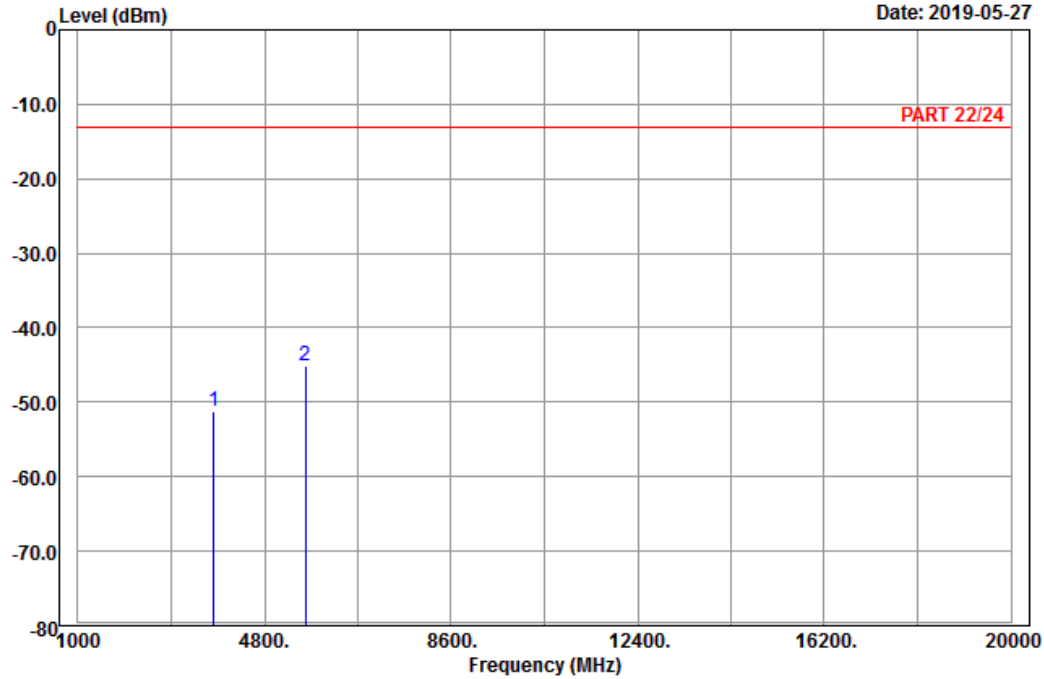

Site : 966 chamber 1  
 Condition: PART 22/24 Vertical  
 Remark : LTE\_Band 2\_Link\_CH18900  
 Tested by: Karl Lee

	Freq	Level	Read Level	Factor	Limit Line	Over Limit	Remark
	MHz	dBm	dBm	dB	dBm	dB	
1	3760.00	-51.28	-67.42	16.14	-13.00	-38.28	Peak
2 pp	5640.00	-45.22	-65.69	20.47	-13.00	-32.22	Peak

High Channel



Bureau Veritas Consumer Products Services Ltd., Taoyuan Branch

A D T

Data: 9

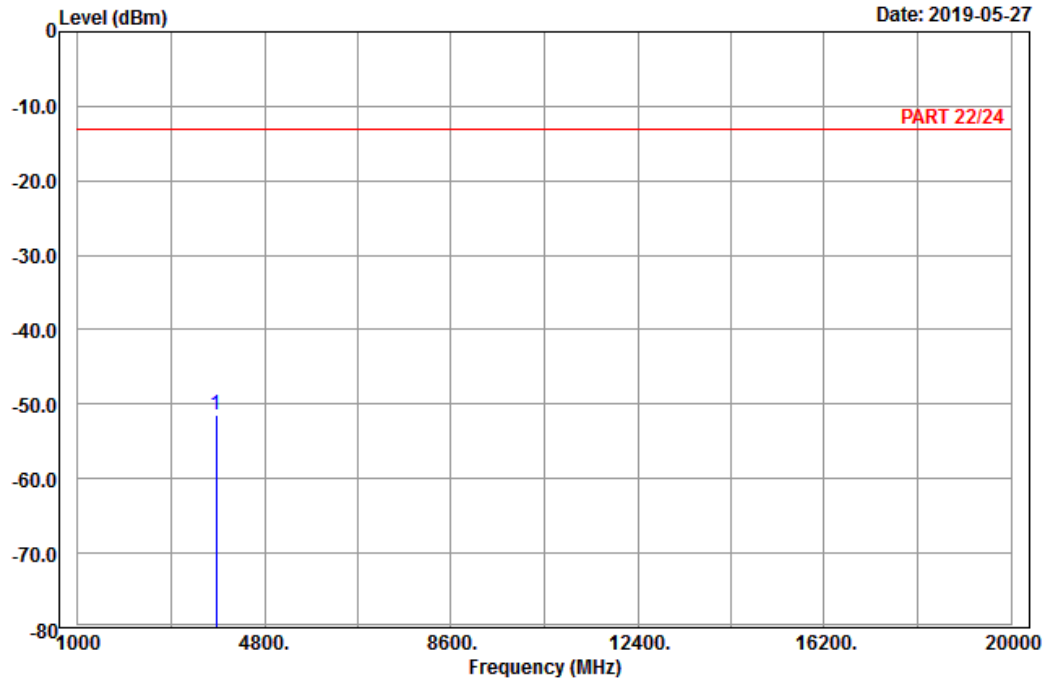

Site : 966 chamber 1  
 Condition: PART 22/24 Horizontal  
 Remark : LTE\_Band 2\_Link\_CH19193  
 Tested by: Karl Lee

Freq	Level	Read Level	Limit Factor	Limit Line	Over Limit	Remark
MHz	dBm	dBm	dB	dBm	dB	
1 pp 3818.60	-51.40	-67.90	16.50	-13.00	-38.40	Peak



Bureau Veritas Consumer Products Services Ltd., Taoyuan Branch

A D T

Data: 10

Date: 2019-05-27

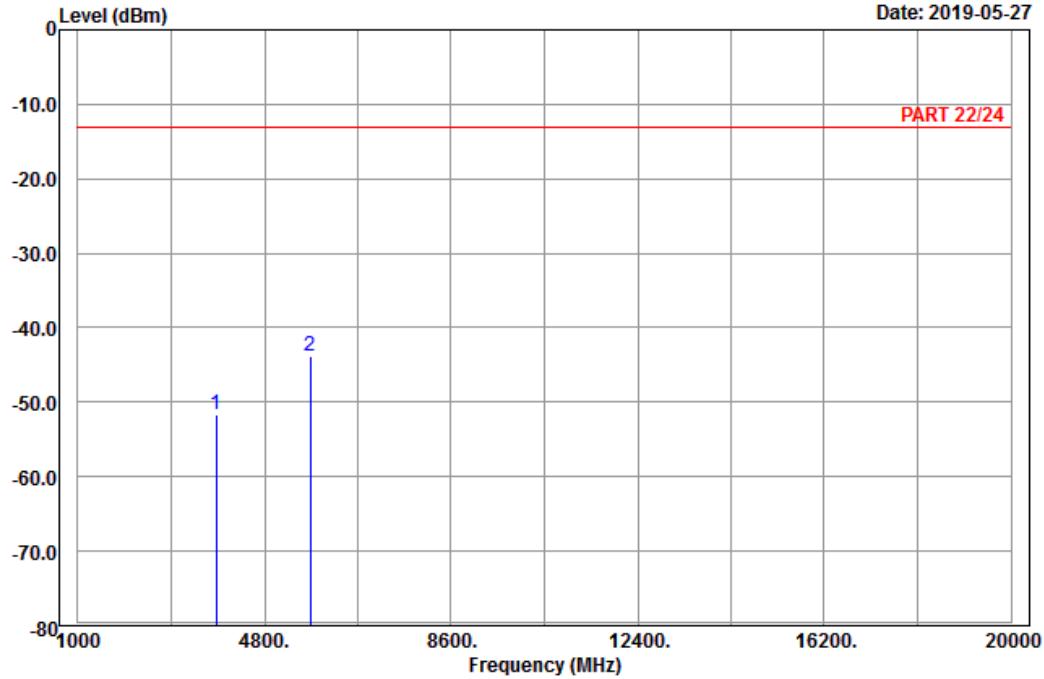

Site : 966 chamber 1  
 Condition: PART 22/24 Vertical  
 Remark : LTE\_Band 2\_Link\_CH19193  
 Tested by: Karl Lee

	Freq	Level	Read Level	Factor	Limit Line	Over Limit	Remark
	MHz	dBm	dBm	dB	dBm	dB	
1	3818.60	-51.56	-68.06	16.50	-13.00	-38.56	Peak
2 pp	5727.90	-43.85	-64.19	20.34	-13.00	-30.85	Peak

Channel Bandwidth: 5 MHz / QPSK  
Low Channel



Bureau Veritas Consumer Products Services Ltd., Taoyuan Branch

A D T

Data: 9

Date: 2019-05-27

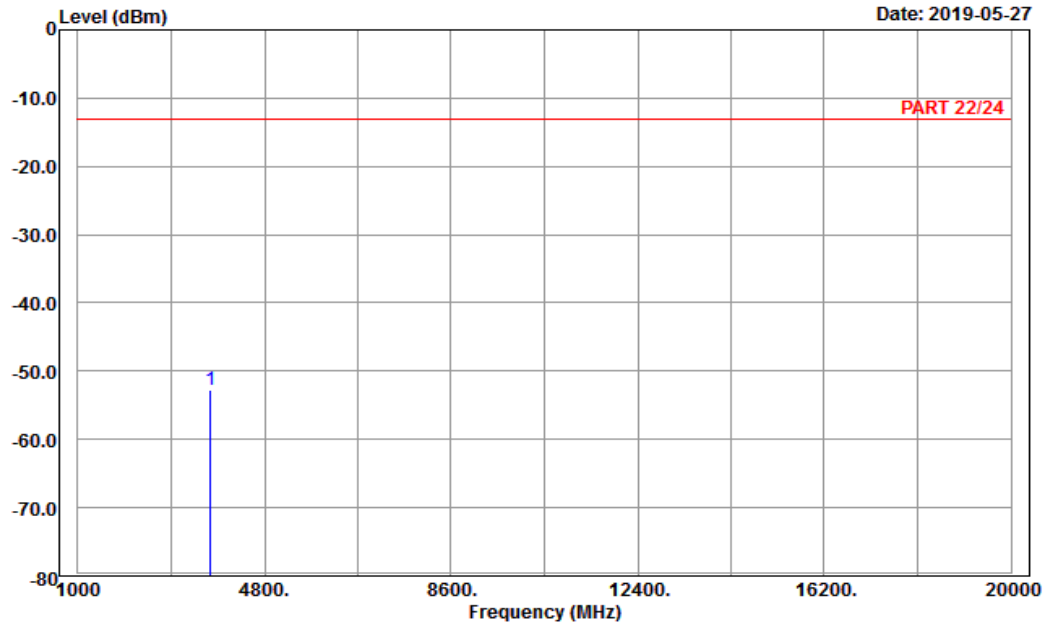

Site : 966 chamber 1  
Condition: PART 22/24 Horizontal  
Remark : LTE\_Band 2\_Link\_CH18625  
Tested by: Karl Lee

	Read	Limit	Over	
Freq	Level	Level	Factor	Line
MHz	dBm	dBm	dB	dBm
1 pp 3705.00	-52.70	-68.58	15.88	-13.00
				-39.70 Peak



Bureau Veritas Consumer Products Services Ltd., Taoyuan Branch

A D T

Data: 10

Date: 2019-05-27

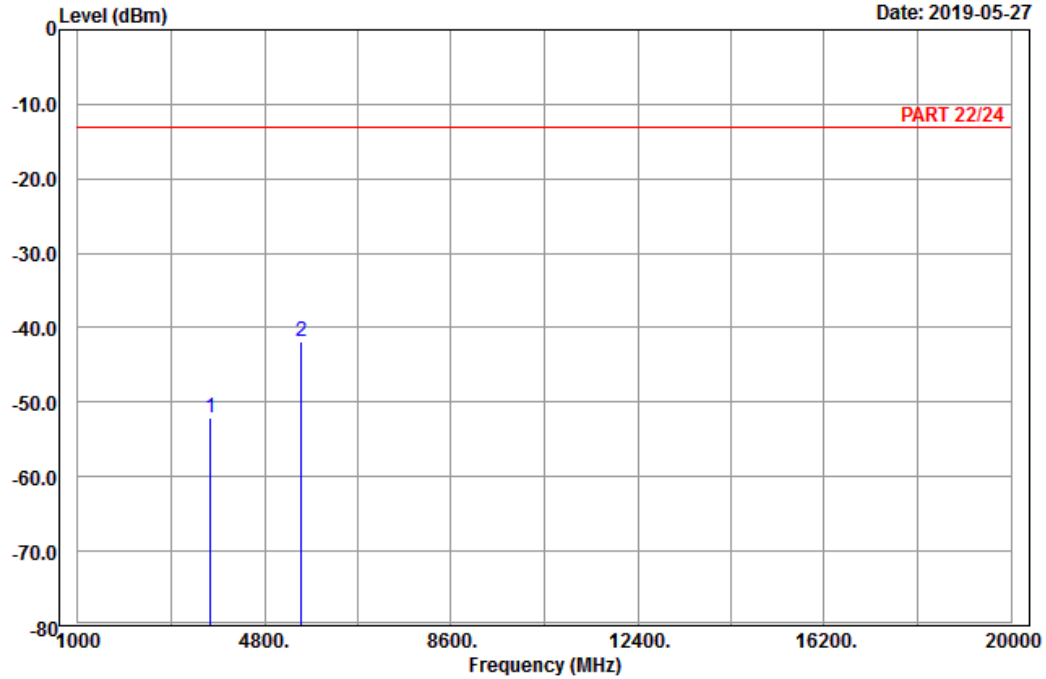

Site : 966 chamber 1  
 Condition: PART 22/24 Vertical  
 Remark : LTE\_Band 2\_Link\_CH18625  
 Tested by: Karl Lee

	Freq	Level	Read Level	Factor	Limit Line	Over Limit	Remark
	MHz	dBm	dBm	dB	dBm	dB	
1	3705.00	-51.99	-67.87	15.88	-13.00	-38.99	Peak
2 pp	5557.50	-41.96	-62.30	20.34	-13.00	-28.96	Peak



Middle Channel



Bureau Veritas Consumer Products Services Ltd., Taoyuan Branch

A D T

Data: 9

Date: 2019-05-27

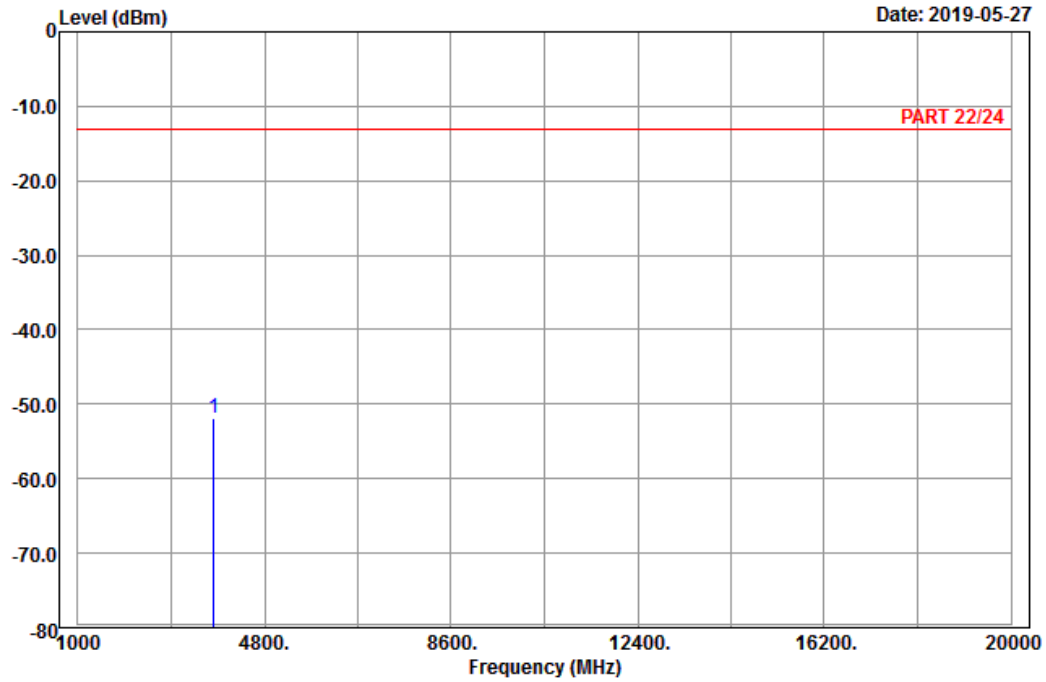

Site : 966 chamber 1  
 Condition: PART 22/24 Horizontal  
 Remark : LTE\_Band 2\_Link\_CH18900  
 Tested by: Karl Lee

Freq	Level	Read Level	Factor	Limit Line	Over Limit	Remark
MHz	dBm	dBm	dB	dBm	dB	
1 pp 3760.00	-51.96	-68.10	16.14	-13.00	-38.96	Peak



Bureau Veritas Consumer Products Services Ltd., Taoyuan Branch

A D T

Data: 10

Date: 2019-05-27

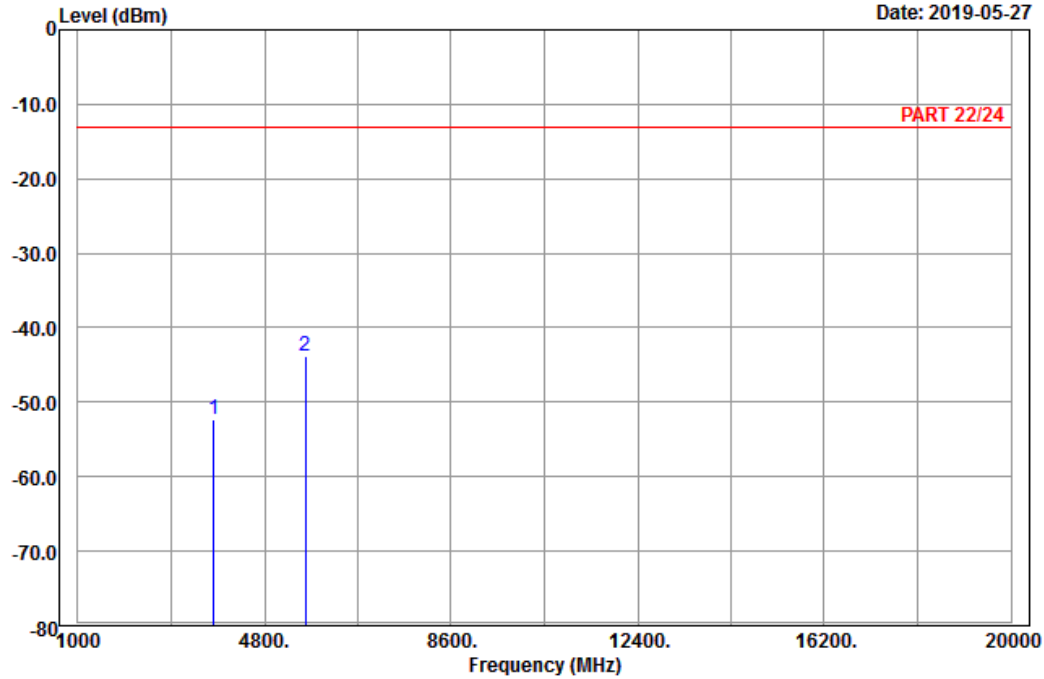

Site : 966 chamber 1  
 Condition: PART 22/24 Vertical  
 Remark : LTE\_Band 2\_Link\_CH18900  
 Tested by: Karl Lee

	Freq	Level	Read Level	Factor	Limit Line	Over Limit	Remark
	MHz	dBm	dBm	dB	dBm	dB	
1	3760.00	-52.37	-68.51	16.14	-13.00	-39.37	Peak
2 pp	5640.00	-43.85	-64.32	20.47	-13.00	-30.85	Peak

High Channel



Bureau Veritas Consumer Products Services Ltd., Taoyuan Branch

A D T

Data: 9

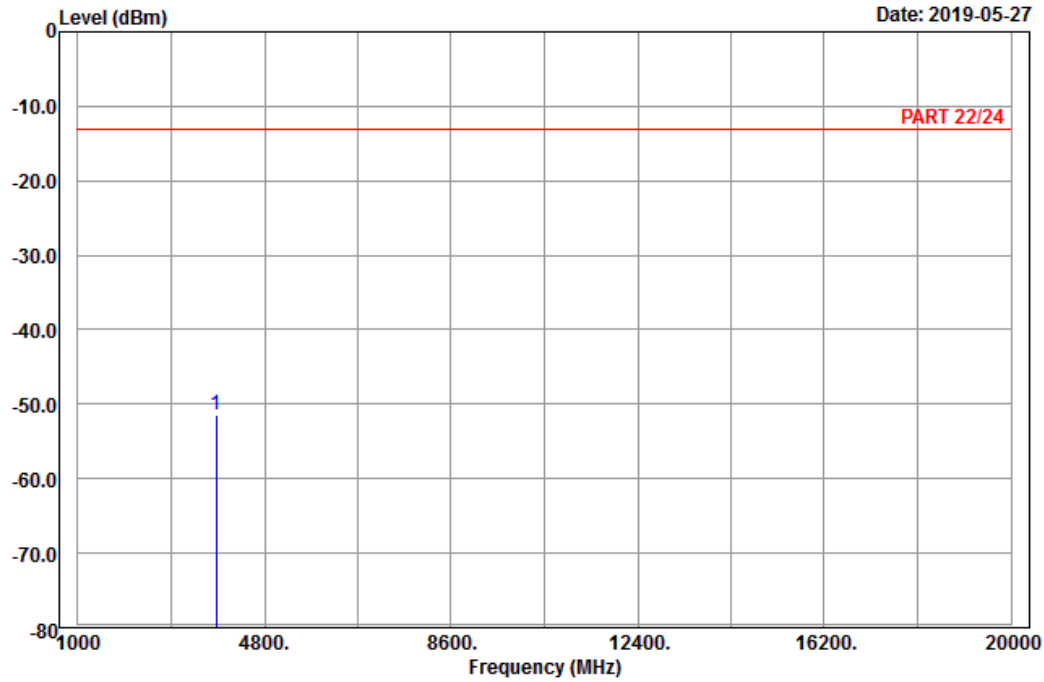

Site : 966 chamber 1  
 Condition: PART 22/24 Horizontal  
 Remark : LTE\_Band 2\_Link\_CH19175  
 Tested by: Karl Lee

Freq	Level	Read Level	Limit Factor	Limit Line	Over Limit	Remark
MHz	dBm	dBm	dB	dBm	dB	
1 pp 3815.00	-51.37	-67.78	16.41	-13.00	-38.37	Peak



Bureau Veritas Consumer Products Services Ltd., Taoyuan Branch

A D T

Data: 10

Date: 2019-05-27

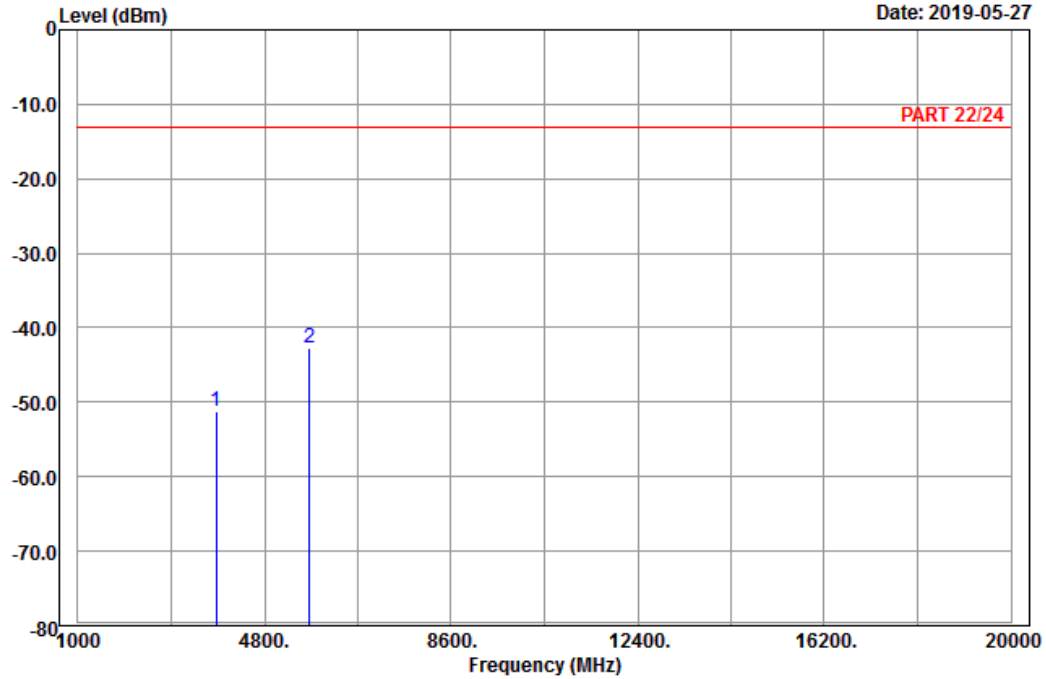

Site : 966 chamber 1  
 Condition: PART 22/24 Vertical  
 Remark : LTE\_Band 2\_Link\_CH19175  
 Tested by: Karl Lee

	Freq	Level	Read Level	Factor	Limit Line	Over Limit	Remark
	MHz	dBm	dBm	dB	dBm	dB	
1	3815.00	-51.24	-67.65	16.41	-13.00	-38.24	Peak
2 pp	5722.50	-42.75	-63.02	20.27	-13.00	-29.75	Peak

Channel Bandwidth: 20 MHz / QPSK  
Low Channel



Bureau Veritas Consumer Products Services Ltd., Taoyuan Branch

A D T

Data: 9

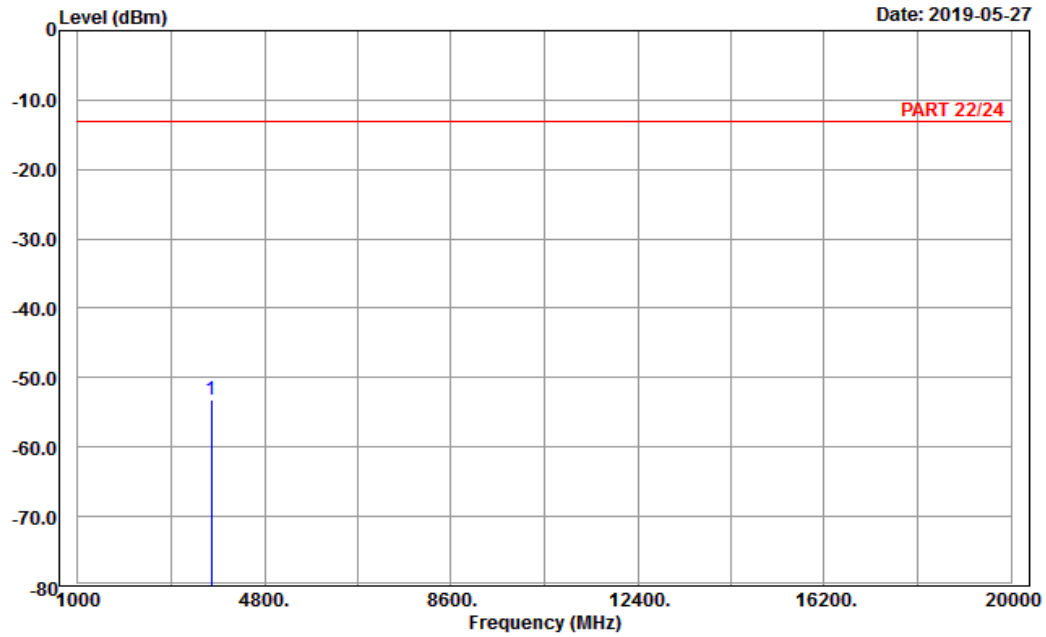

Site : 966 chamber 1  
Condition: PART 22/24 Horizontal  
Remark : LTE\_Band 2\_Link\_CH18700  
Tested by: Karl Lee

	Freq	Level	Read Level	Factor	Limit Line	Over Limit	Remark
	MHz	dBm	dBm	dB	dBm	dB	
1 pp	3720.00	-53.17	-69.14	15.97	-13.00	-40.17	Peak



Bureau Veritas Consumer Products Services Ltd., Taoyuan Branch

A D T

Data: 10

Date: 2019-05-27

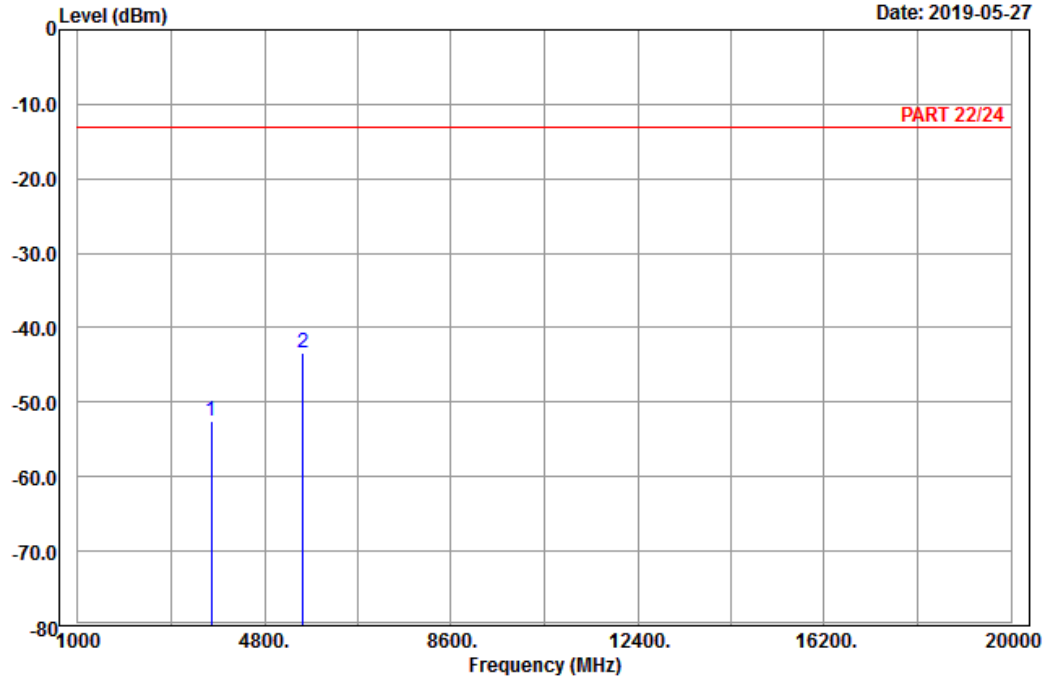

Site : 966 chamber 1  
 Condition: PART 22/24 Vertical  
 Remark : LTE\_Band 2\_Link\_CH18700  
 Tested by: Karl Lee

	Freq	Level	Read Level	Factor	Limit Line	Over Limit	Remark
	MHz	dBm	dBm	dB	dBm	dB	
1	3720.00	-52.58	-68.55	15.97	-13.00	-39.58	Peak
2 pp	5580.00	-43.43	-63.80	20.37	-13.00	-30.43	Peak

Middle Channel



Bureau Veritas Consumer Products Services Ltd., Taoyuan Branch

A D T

Data: 13

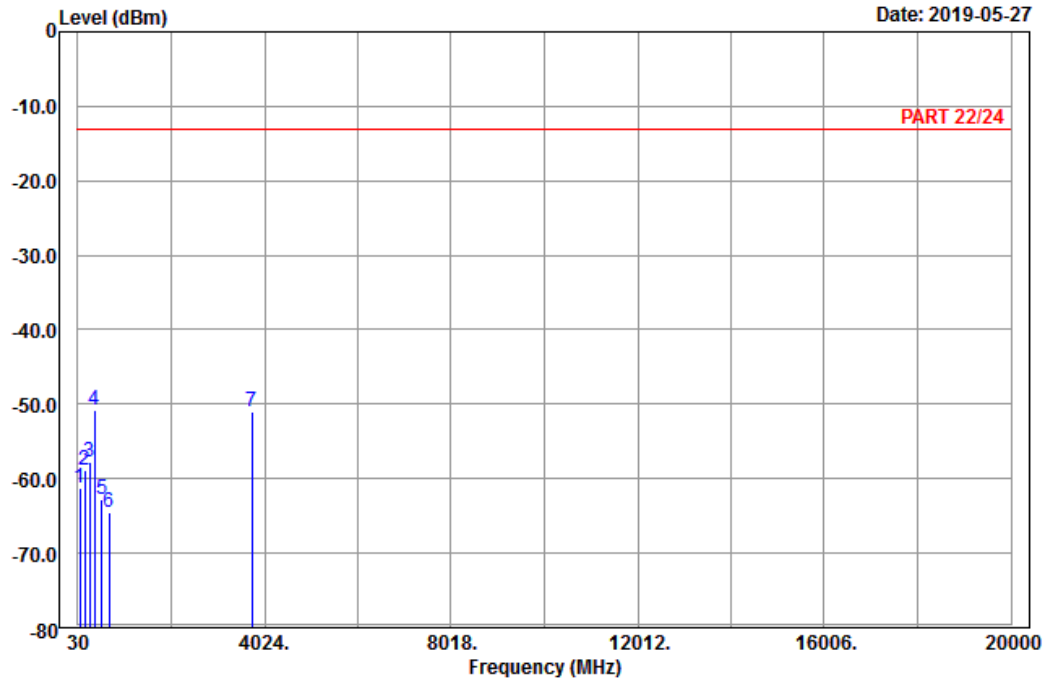

Site : 966 chamber 1  
 Condition: PART 22/24 Horizontal  
 Remark : LTE\_Band 2\_Link\_CH18900  
 Tested by: Karl Lee

	Freq	Level	Read Level	Factor	Limit Line	Over Limit	Remark
	MHz	dBm	dBm	dB	dBm	dB	
1	65.91	-61.15	-47.91	-13.24	-13.00	-48.15	Peak
2	183.36	-58.78	-53.16	-5.62	-13.00	-45.78	Peak
3	288.93	-57.68	-51.82	-5.86	-13.00	-44.68	Peak
4 pp	393.10	-50.71	-47.61	-3.10	-13.00	-37.71	Peak
5	545.00	-62.69	-60.67	-2.02	-13.00	-49.69	Peak
6	690.60	-64.54	-64.21	-0.33	-13.00	-51.54	Peak
7	3760.00	-50.99	-67.13	16.14	-13.00	-37.99	Peak



Bureau Veritas Consumer Products Services Ltd., Taoyuan Branch

A D T

Data: 14

Date: 2019-05-27

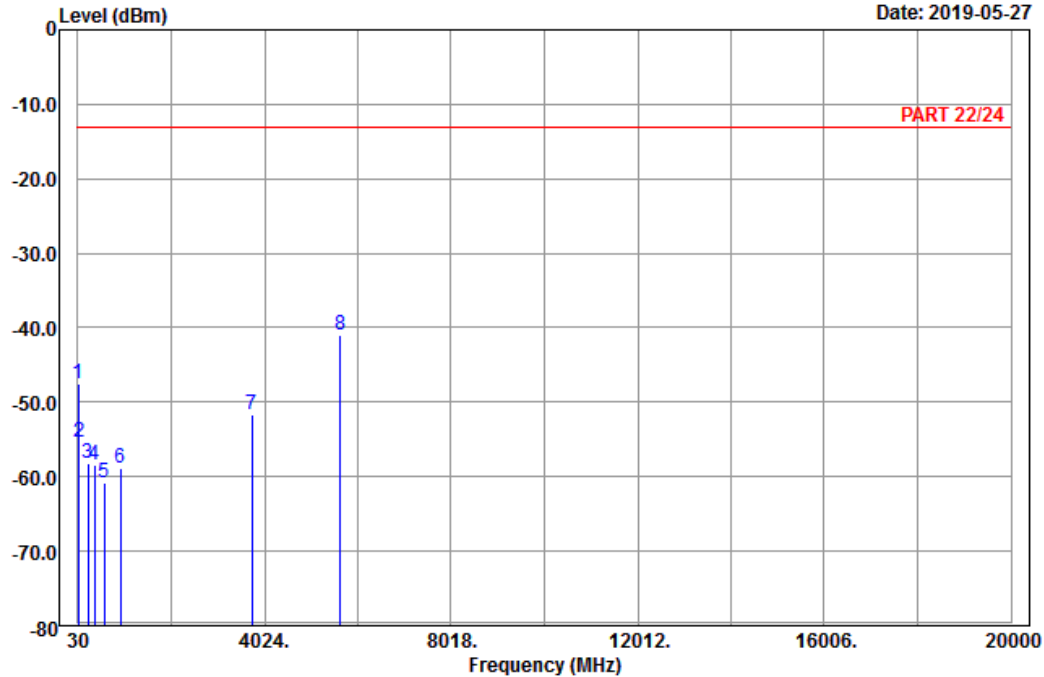

Site : 966 chamber 1  
 Condition: PART 22/24 Vertical  
 Remark : LTE\_Band 2\_Link\_CH18900  
 Tested by: Karl Lee

	Freq	Level	Read Level	Factor	Limit Line	Over Limit	Remark
	MHz	dBm	dBm	dB	dBm	dB	
1	35.67	-47.59	-36.87	-10.72	-13.00	-34.59	Peak
2	63.75	-55.31	-41.80	-13.51	-13.00	-42.31	Peak
3	252.21	-58.11	-52.59	-5.52	-13.00	-45.11	Peak
4	387.50	-58.48	-55.12	-3.36	-13.00	-45.48	Peak
5	586.30	-60.82	-60.68	-0.14	-13.00	-47.82	Peak
6	942.60	-58.94	-63.74	4.80	-13.00	-45.94	Peak
7	3760.00	-51.63	-67.77	16.14	-13.00	-38.63	Peak
8 pp	5640.00	-40.89	-61.36	20.47	-13.00	-27.89	Peak



## High Channel



Bureau Veritas Consumer Products Services Ltd., Taoyuan Branch

A D T

Data: 9

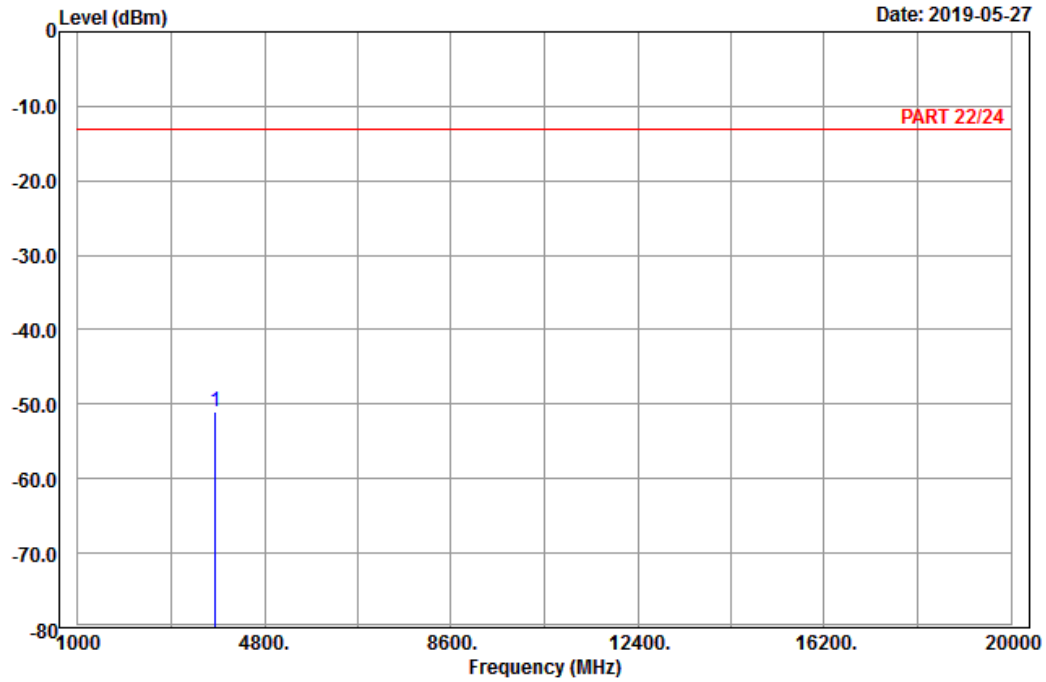

Site : 966 chamber 1  
 Condition: PART 22/24 Horizontal  
 Remark : LTE\_Band 2\_Link\_CH19100  
 Tested by: Karl Lee

Freq	Level	Read Level	Factor	Limit Line	Over Limit	Remark
MHz	dBm	dBm	dB	dBm	dB	
1 pp 3800.00	-50.98	-67.39	16.41	-13.00	-37.98	Peak



Bureau Veritas Consumer Products Services Ltd., Taoyuan Branch

A D T

Data: 10

Date: 2019-05-27

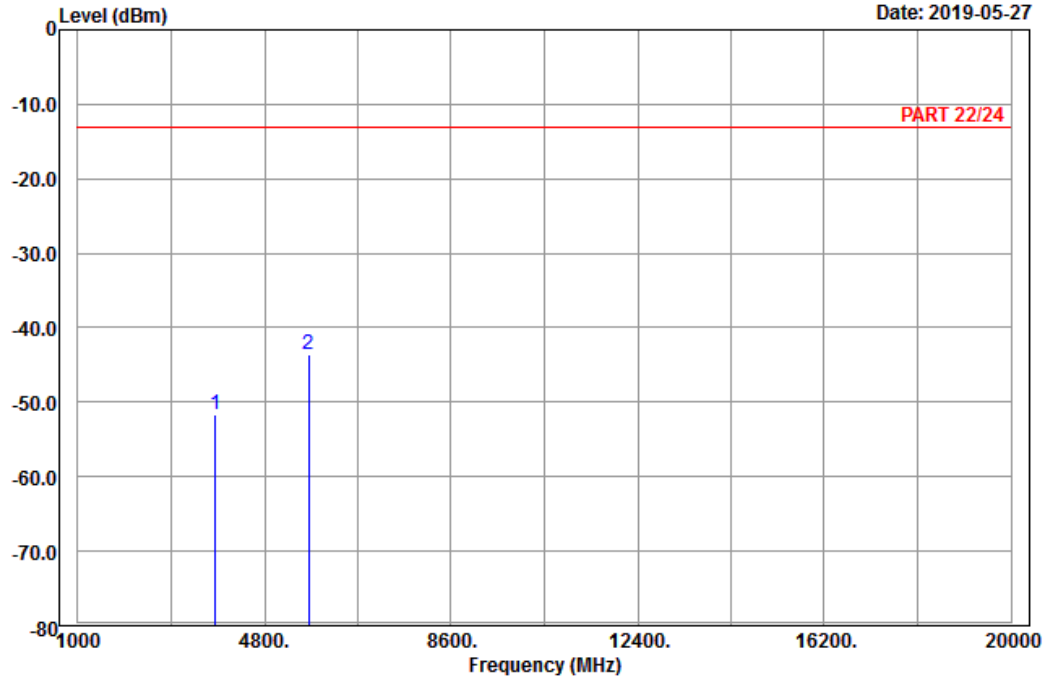

Site : 966 chamber 1  
 Condition: PART 22/24 Vertical  
 Remark : LTE\_Band 2\_Link\_CH19100  
 Tested by: Karl Lee

	Freq	Level	Read Level	Factor	Limit Line	Over Limit	Remark
	MHz	dBm	dBm	dB	dBm	dB	
1	3800.00	-51.67	-68.08	16.41	-13.00	-38.67	Peak
2 pp	5700.00	-43.67	-63.88	20.21	-13.00	-30.67	Peak

## 5 Pictures of Test Arrangements

Please refer to the attached file (Test Setup Photo).

## Appendix – Information of the Testing Laboratories

We, Bureau Veritas Consumer Products Services (H.K.) Ltd., Taoyuan Branch, were founded in 1988 to provide our best service in EMC, Radio, Telecom and Safety consultation. Our laboratories are FCC recognized accredited test firms and accredited according to ISO/IEC 17025.

If you have any comments, please feel free to contact us at the following:

**Lin Kou EMC/RF Lab**

Tel: 886-2-26052180

Fax: 886-2-26051924

**Hsin Chu EMC/RF/Telecom Lab**

Tel: 886-3-6668565

Fax: 886-3-6668323

**Hwa Ya EMC/RF/Safety Lab**

Tel: 886-3-3183232

Fax: 886-3-3270892

**Email:** [service.adt@tw.bureauveritas.com](mailto:service.adt@tw.bureauveritas.com)

**Web Site:** [www.bureauveritas-adt.com](http://www.bureauveritas-adt.com)

The address and road map of all our labs can be found in our web site also.

--- END ---