

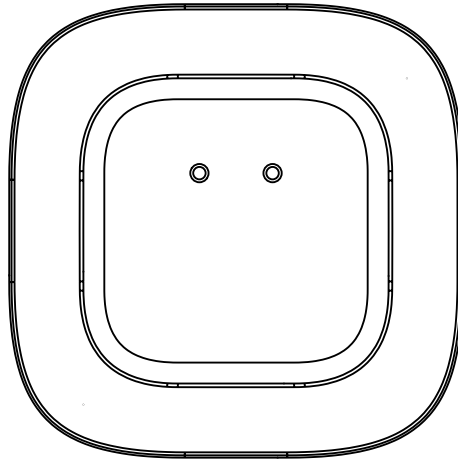

## User Guide

YS7903-UC



Water Leak Sensor

# Contents

Introduction	1
Features	2
Product Requirements	2
What's In The Box	2
Set Up Water Leak Sensor	4
Sensor Placement	8
Using YoLink App with Water Leak Sensor	9
YoLink Control	12
Maintaining the Water Leak Sensor	15
Specifications	17
Troubleshooting	18
Customer Service & Warranty	19

# Introduction

Water Leak Sensor is widely used in water leak detection. There will have an alert when any of the three sets of probes were under the water. Download YoLink App, add Water Leak Sensor to your smart home system, which will able to monitor your home's security in real time.

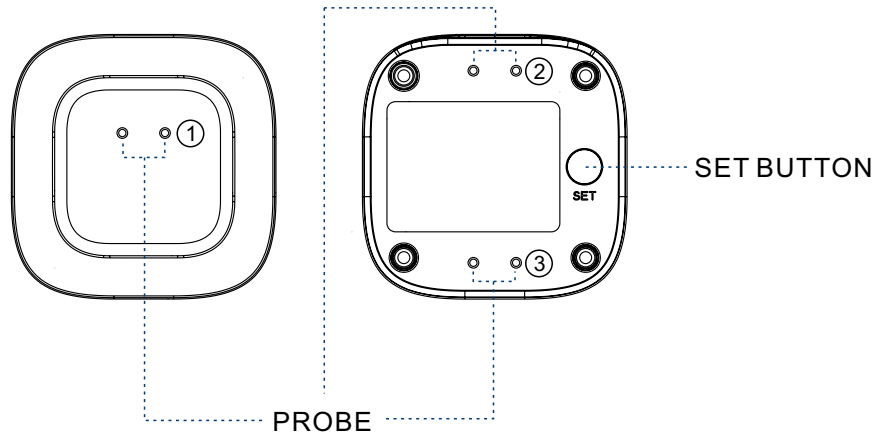

LED lights can show the current status of device. See the explanation below:

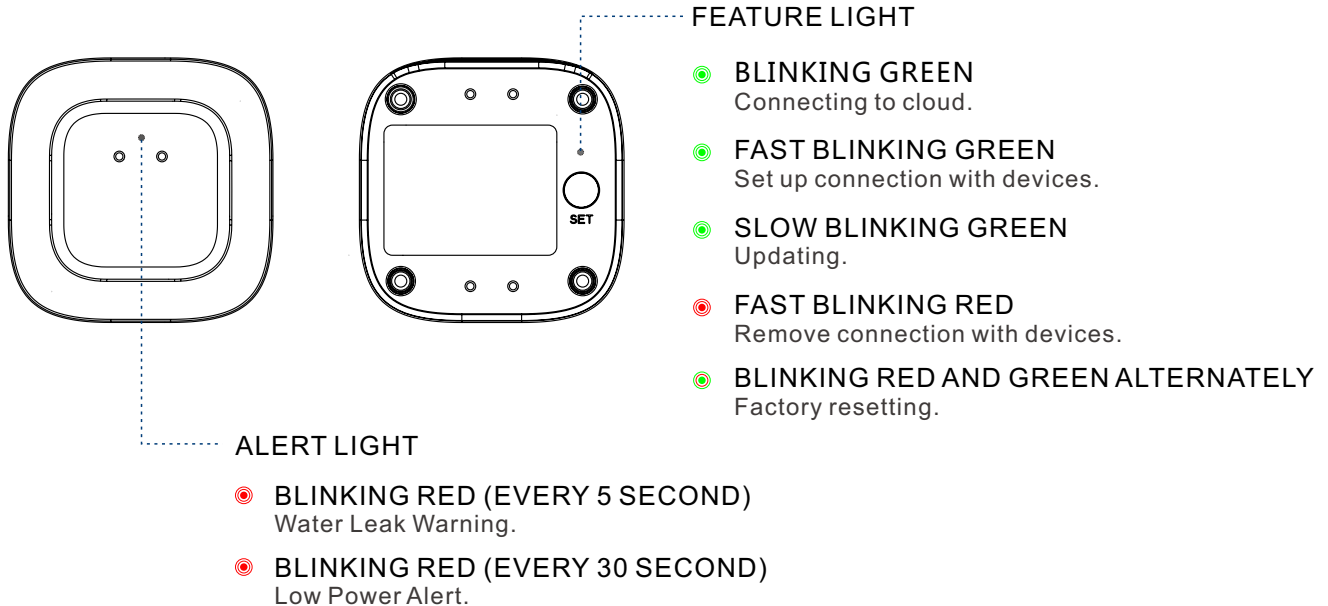

# Features

**Real-time Status** - Monitor the real-time state of water leak sensor via YoLink App.

**Battery Status** - Update battery level and send low battery alert.

**YoLink Control** - Trigger an action of certain YoLink devices without internet.

**Automation** - Set up rules for “If this then that” function.

# Product Requirements

- A YoLink Hub.
- A smartphone or tablet running iOS 9 or higher; Android 4.4 or higher.

# What's In The Box

- Qty 1 - Water Leak Sensor
- Quick Start Guide

# Set Up Water Leak Sensor

Follow the steps below to set up your Water Leak Sensor via YoLink App.

## Step 1: Set up YoLink App

- Get the YoLink App from the Apple App Store or Google Play.



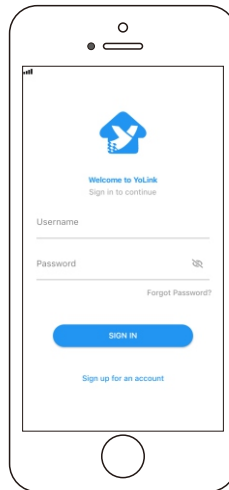

## Step 2: Log in or sign up with YoLink account

- Open the App. Use your YoLink account to log in.
- If you don't have a YoLink account, tap **Sign up for an account** and follow the steps to sign up an account.



## Step 3: Add device to YoLink App

- Tap the “- a. **Name** - Name Water Leak Sensor.
- b. **Room** - Choose a room for Water Leak Sensor.
- c. **Favourite** - Click “

The diagram illustrates the process of adding a device to the YoLink app in four stages:

  - Stage 1:** The YoLink app's 'Rooms' screen is shown. The 'Add Device' button is highlighted with an orange box. A dashed line connects this button to the device in the next stage.
  - Stage 2:** A physical device, a Water Leak Sensor, is shown. It has a QR code on its top surface and a 'SET' button on its right side.
  - Stage 3:** The 'Add Device' screen in the app is shown. The 'Name' field is highlighted with an orange box and labeled 'a'. The 'Room' field is highlighted with an orange box and labeled 'b'. The 'Favourite' field is highlighted with an orange box and labeled 'c'. The 'Bind device' button is visible at the bottom.
  - Stage 4:** The 'Add Device' screen is shown again, but now the 'Bind device' button is highlighted with an orange box, indicating the final step in the process.



## Step 4: Connect to the cloud

- Press the SET button once and your device will connect to the cloud automatically.
- Place the device to whenever you want to monitor.

### Note

- Make sure you hub is connected to internet.



# Sensor Placement

Located the water leak sensor in a location that may experience a water leak.



# Using YoLink App with Water Leak Sensor

## Device Alert

- Any of a set of probes are touched by water at the same time, an alert will send to your YoLink account.

## Note

- Interval between two alerts is default to be 5 minutes.

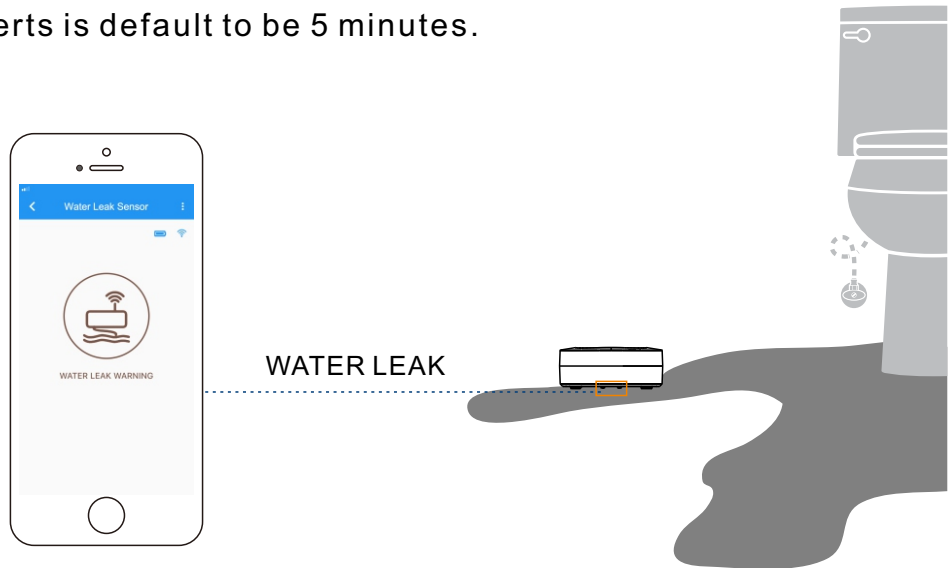

## Details

You can customize the name, set the room, set the alert interval, enable/disable alert, add to/remove from favourite, check device history.

- a. **Name** - Name Water Leak Sensor.
- b. **Room** - Choose a room for Water Leak Sensor.
- c. **Favourite** - Click “  ” icon to add/remove from Favourite.
- d. **Alert** - Click enable/disable alert.
- e. **Alert Interval** - Set a time between two alerts after water leaking.
- f. **History** - Check the history log for the Water Leak Sensor.
- g. **Delete** - The device will be remove from your account.

- Tap the “Water Lwak Sensor” in App to go to its controls.
- Tap the “  ” icon at the top-right corner to go to details.
- Tap the icon for each of the settings you want to personalize.

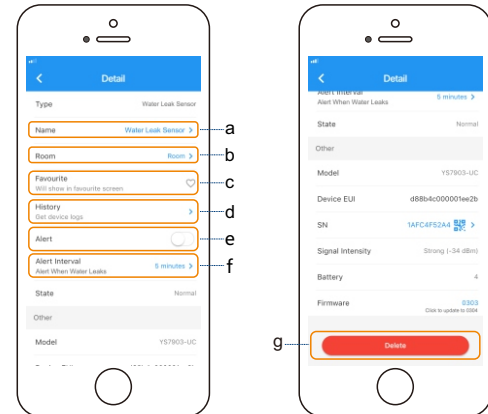

# Automation

Automation allows you to set up “If this then that” rules so the devices could act automatically.

- Tap “Smart” to switch to Smart screen and tap “Automation”.
- Tap “ + ” to create an automation.
- To set an Automation, you will need to set a trigger time, local weather condition, or choose a device with certain stage as a triggered condition. Then set one or more devices, scenes to be executed.

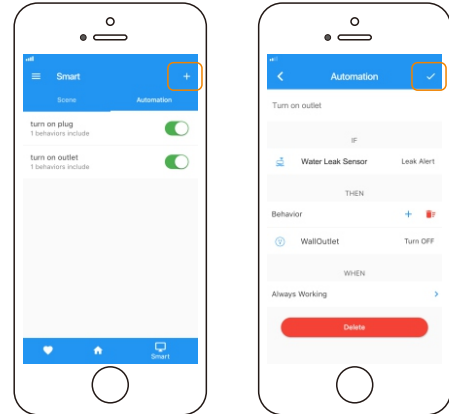

# YoLink Control

YoLink Control is our unique “device to device” control technology. Under YoLink Control, the devices could be controlled without internet or Hub. Device which send out command is called controller(Master). Device which receive command and act accordingly is called responder(Receiver).

You will need to set it up physically.

## Pairing

- Find a water leak sensor as controller(Master). Hold the set button for 5-10 seconds, the feature light will flash green quickly.
- Find an action device as responder (Receiver). Hold the power/set button for 5-10 seconds, the device will enter the pairing mode.
- After pairing succeed, the feature light will stop flashing.
- When there is a water leak warning, the responder will turn off as well.

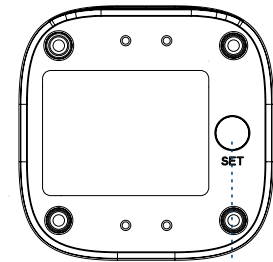

SET BUTTON

## Un-pairing

- Find the controller(Master) water leak sensor. Hold the set button for 10-15 seconds, the feature light will flash red quickly.
- Find the responder(Receiver) action device. Hold the power/set button for 10-15 seconds, the device will enter the un-pairing mode.
- The above two devices will unpair by themselves and the feature light stops flashing.
- After unbundling, when there is a water leak, the responder will no longer turn off.

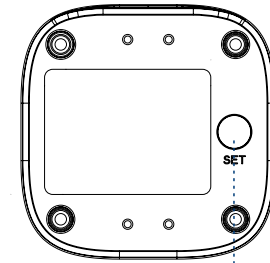

SET BUTTON

## Responder List

- YS4907-UC Gas/Water Valve

Continuously updating..

# YoLink Control Diagram

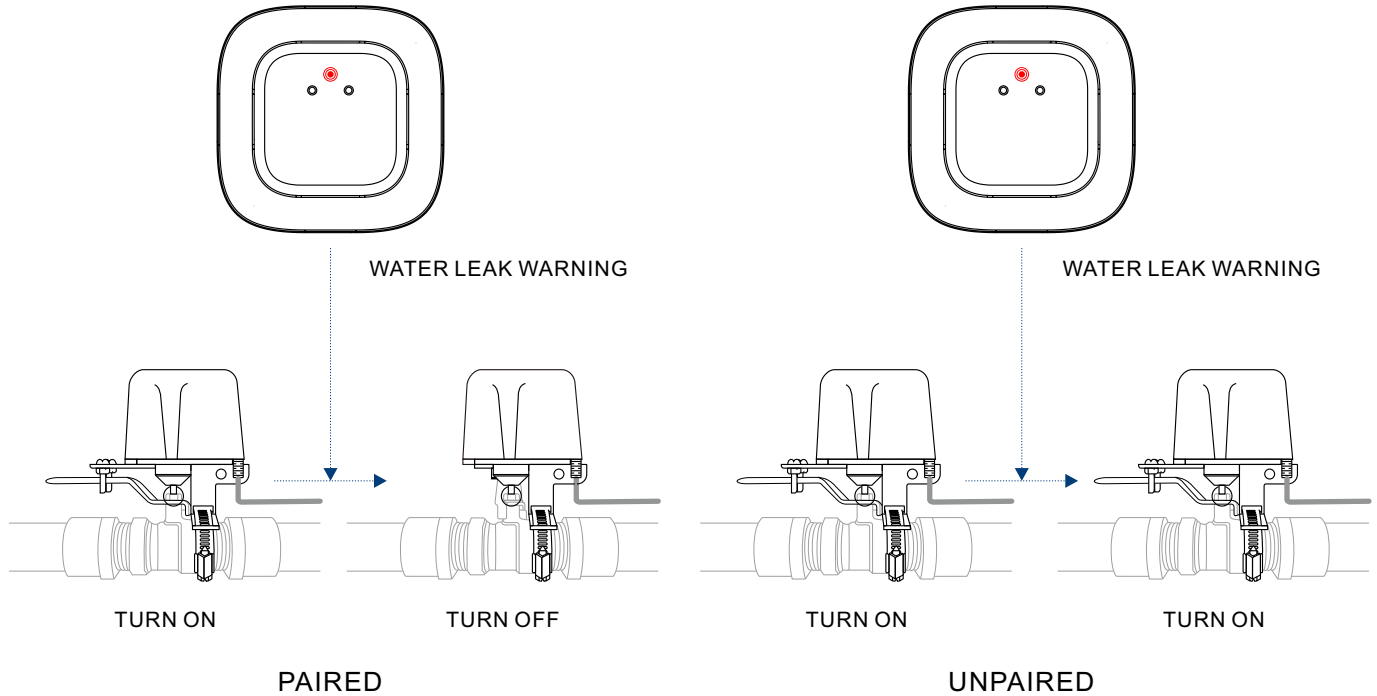



# Maintaining the Water Leak Sensor

## Firmware Update

Ensure our customer have the best user experience. Highly recommend you could update our newest version firmware.

- Tap the “Water Lwak Sensor” in App to go to its controls.
- Tap the “ : ” icon at the top-right corner to go to details.
- Tap “Firmware”.
- The feature light will be slowly blinking green during the update and stop blinking when the update done.

### Note

- Only the Water Leak Sensor that is currently reachable and has an available update will be shown on the Details screen.

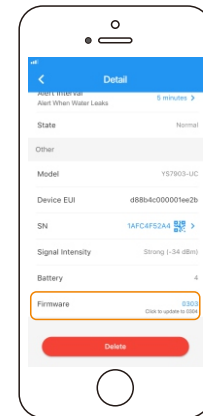

## Factory Reset

Factory reset will erase all your settings and bring it back to default. After the factory reset, your device will still in your Yolink account.

- Hold the set button for 20-25 seconds until the feature light blinks red and green alternately.
- Factory reset will be done when the feature light stops flashing.

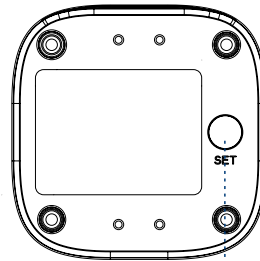

SET BUTTON

# Specifications

---

Voltage: 3V DC (2 - AAA battery)

---

Environment: Working Temperature: 0°C~50°C (32°F~122°F)  
Working Humidity: ≤100%RH non-condensing

---

# Troubleshooting

Problem	Possible Reason	Solution
No alert or light.	Water leak sensor is battery died.	Please replace the battery.
Water leak sensor is offline.	Hub is offline.	Please reconnect your hub to the Internet and press the set button of water leak sensor once.
	Hub is powered off.	Please power on the hub again and press the set button of Water Leak Sensor once.
	Water leak sensor is battery died.	Please replace the battery.
	Device malfunction	Please contact customer service.
LED blinking, no alert.	Notification has been turned off in YoLink App.	Please turn notification on in the setting page of YoLink App.
Alert received in App but no LED blinking.	Please contact our customer service.	

**If you are unable to get your water leak sensor working  
Please contact Our Customer Service during business hours**

US Live Tech Support: 1-844-292-1947 M-F 9am - 5pm PST

Email: [support@YoSmart.com](mailto:support@YoSmart.com)

YoSmart Inc. 17165 Von Karman Avenue, Suite 105, Irvine, CA 92614

**WARRANTY** 2 Year Limited Electrical Warranty

YoSmart warrants to the original residential user of this product that it will be free from defects in materials and workmanship, under normal use, for 2 year from the date of purchase. User must provide a copy of original purchase receipt. This warranty Does Not Cover abuse or misused products or products used in commercial applications. This warranty does not apply to water leak sensors that have been improperly installed, modified, put to a use other than designed, or subjected to acts of God (such as floods, lightning, earthquakes, etc.). This warranty is limited to repairing or replacing of this water leak sensor only at YoSmart's sole discretion. YoSmart will NOT be liable for the cost of installing, removing, nor reinstalling this product, nor direct, indirect, or consequential damages to persons or property resulting from the use of this product. This warranty only covers the cost of replacement parts or replacement units, it does not cover shipping & handling fees.

To implement this warranty please give us a call during business hours at 1-844-292-1947, or visit [www.yosmart.com](http://www.yosmart.com).

REV1.0 Copyright 2019. YoSmart, Inc. All rights reserved.

## FCC Statement

This equipment has been tested and found to comply with the limits for a Class B digital device, pursuant to part 15 of the FCC Rules. These limits are designed to provide reasonable protection against harmful interference in a residential installation. This equipment generates, uses and can radiate radio frequency energy and, if not installed and used in accordance with the instructions, may cause harmful interference to radio communications. However, there is no guarantee that interference will not occur in a particular installation. If this equipment does cause harmful interference to radio or television reception, which can be determined by turning the equipment off and on, the user is encouraged to try to correct the interference by one or more of the following measures:

- Reorient or relocate the receiving antenna.
- Increase the separation between the equipment and receiver.
- Connect the equipment into an outlet on a circuit different from that to which the receiver is connected.
- Consult the dealer or an experienced radio / TV technician for help.

This device complies with part 15 of the FCC Rules. Operation is subject to the following two conditions:

- 1) This device may not cause harmful interference.
- 2) This device must accept any interference received, including interference that may cause undesired operation. Any changes or modifications not expressly approved by the party responsible for compliance could void the user's authority to operate the equipment.

Note: The manufacturer is not responsible for any radio or TV interference caused by unauthorized modifications to this equipment. Such modifications could void the user's authority to operate the equipment.

## FCC RF Radiation Exposure Statement

This equipment complies with FCC RF radiation exposure limits set forth for an uncontrolled environment. This device and its antenna must not be co-located or operating in conjunction with any other antenna or transmitter.

“To comply with FCC RF exposure compliance requirements, this grant is applicable to only Mobile Configurations. The antennas used for this transmitter must be installed to provide a separation distance of at least 20 cm from all persons and must not be co-located or operating in conjunction with any other antenna or transmitter.”