

YOLINK

Contact Sensor

(Indoor/Outdoor)

YS7707-UC

Installation & User Guide

Rev 1.0

Contents

In the Box	1
Introduction	2
Set Up	5
Installation	7
Using the YoLink App	13
About YoLink <i>Control</i>	18
Maintenance	24
Specifications	27
Troubleshooting	29
Warning	30
Customer Service & Warranty	32

In the Box

- A. Contact Sensor (with Reed Switch)
- B. Magnet
- C. AA Battery (2)
- D. Self-tapping Screw (M3) (4)
- E. Double-sided Tape
- F. Quick Start Guide

A.

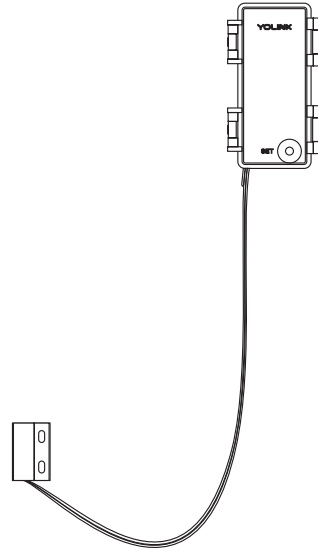

B.



C.



D.



E.

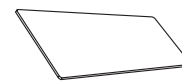

F.



Introduction

The YoLink Contact Sensor is a wireless smart contact monitoring device, that can monitor the opened or closed status of doors, windows and gates, as well as the status of relays and contact closure outputs on non-smart devices and equipment [normally-closed, "dry" (no voltage) contact closure or relay type outputs, only]. Monitor the opened/closed status of windows/doors/gates using the included attached magnetic contacts or optionally connect the sensor to existing or new door/window contacts. The opened/closed status will be displayed on the YoLink app, and the status may be used as a trigger for custom automations (for example, turn on a light when a door is opened), as well as to initiate smartphone alerts and notifications based on your preferences. Additionally, the Open Remind feature can alert you to a door/window/gate or connected device left open for too long

- **Door or window monitoring:** with the magnet installed on the door or window (moving part) and the reed switch installed on the frame (fixed part), with the door/window closed, as the distance (gap) between the magnet and the reed switch is increased, the sensor will indicate the door or window is now open. When the magnet is again adjacent to the reed switch, the sensor will now indicate the door/window is closed
- **Contact closure monitoring:** by removing the included magnetic contacts and connecting the cable to a contact closure type output, the sensor can monitor the open/closed status of non-smart devices and equipment (normally, open status is warning, closed status is warning removed or normal monitoring status, depends on the self-definition of non-smart devices and equipment)

** Additional applications and additional devices for use with the Contact Sensor include: dry-contact relays, non-smart door contacts, water leak detectors, temperature and humidity sensors, tamper switches, tilt alarms contacts swing type doors and gates, cantilever gates, sliding doors and gates, cabinet, refrigerator and freezer doors, drawers, storage boxes, safes, tool chests, gun safes/cabinets. For garage doors, consider one of our garage door kits.*

Mounting Slot
** Use screws to mount the magnet on the wall*

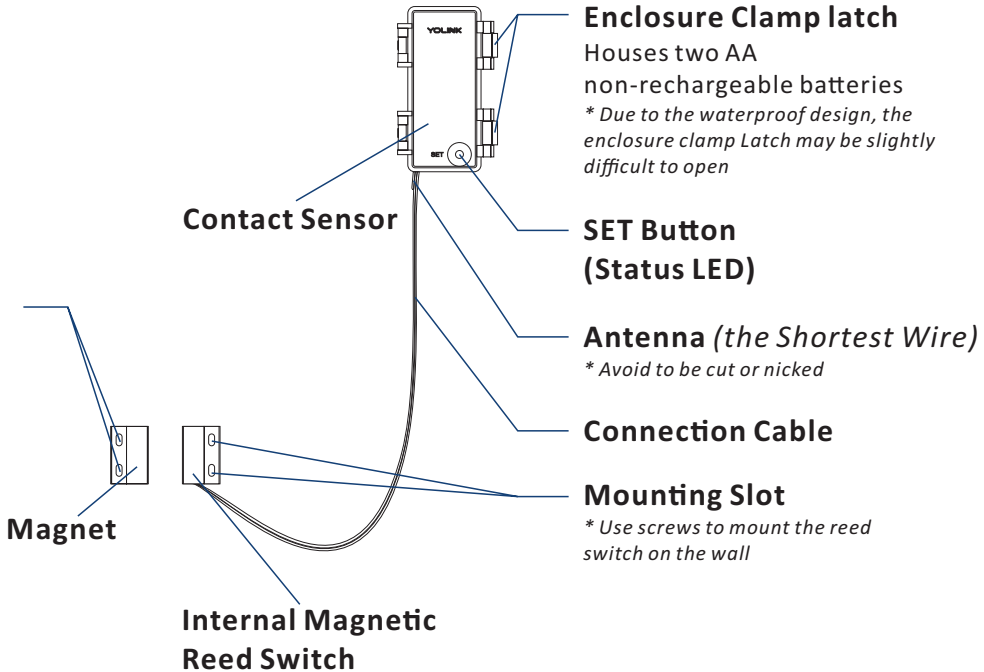

The LED light indicates the current status of the sensor:

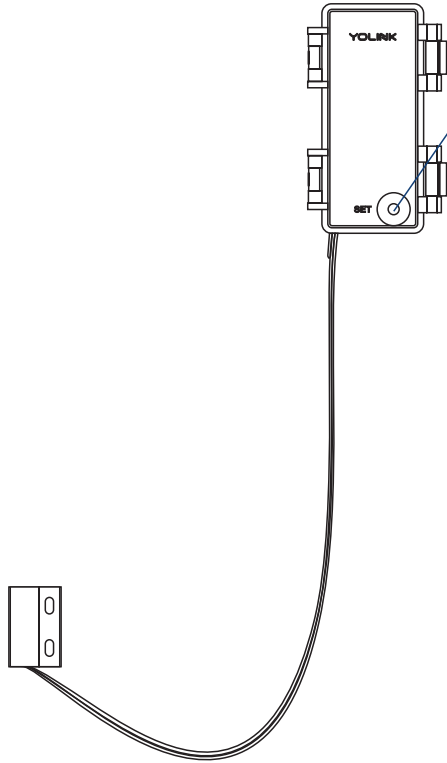

- **Blinking Red Once**
Alert Mode (Door is Opened or Closed)
- **Blinking Green**
Connecting to Cloud
- **Fast Blinking Green**
Establishing Connection with YoLink System (YoLink *Control*)
- **Slow Blinking Green**
Updating
- **Fast Blinking Red**
Removing Connection to YoLink System (YoLink *Control*)
- **Blinking Red And Green Alternately**
Restoring to Factory Default

Set Up

Follow the steps below to set up your Contact Sensor via the YoLink app

Set Up - First-Time YoLink Users (*Existing users proceed to **Add Device**, next page*)

*** Get ready:** To set up and use your Contact Sensor, you will need an Apple iPhone or tablet that is iOS 9.0 or higher, or an Android phone or tablet that is Android 4.4 or higher

- Download YoLink app through Apple App Store or Google Play Store
- Log in or create a new account if required
- YoLink Hub is required to set up your Contact Sensor. Please set up your YoLink Hub first (refer to YoLink Hub manual)

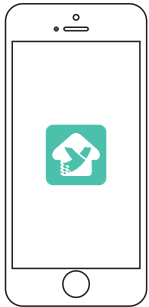

Download, and log in to YoLink app

1

** Make sure your hub is connected to the internet (green LED indicator is blinking, blue LED indicator is always on)*

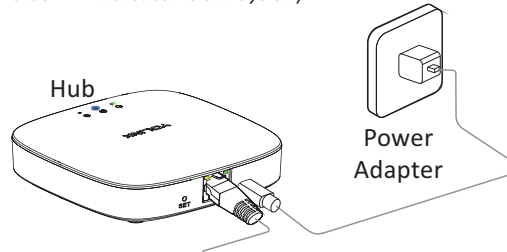

Set up YoLink Hub

2

** Ethernet patch cable (included) to your network (router, switch, etc.), recommended, but optional. Otherwise connect your Hub to your home Wi-Fi network. Refer to the Hub set up manual for more information:*



YS1603-UC_User Guide

Add Device

- With a lifting/prying action on the two clamp latches, open the cover on the sensor
- Tap “” button, then scan QR Code on the device
- Press the SET button (on front of sensor) once after installing the batteries, the Status LED will blink several times (red, then green). The green LED indicates the device is online and ready to use

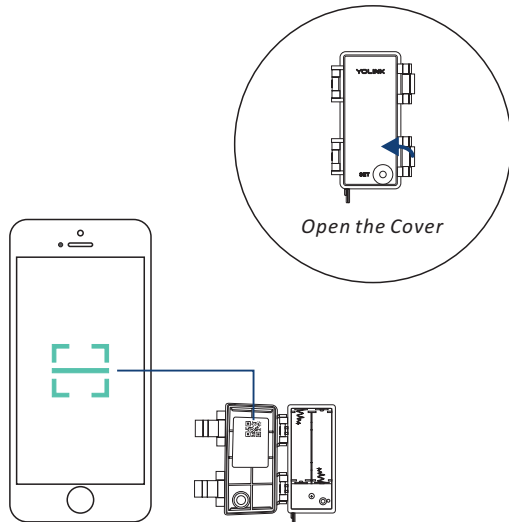

Tap “” button to add devices

1

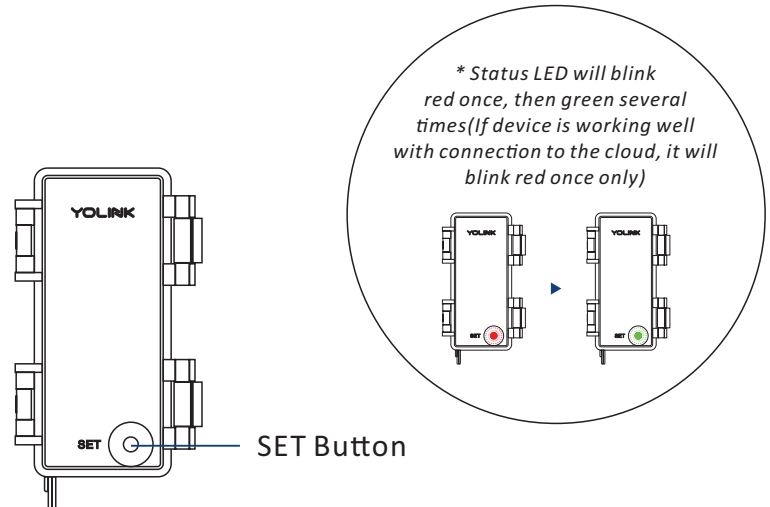

Press the SET button (on front of sensor) once

2

Installation

Test the Contact Sensor, Reed Switch and Magnet Location Before Installation

- The contact sensor, reed switch and magnet are very difficult to relocate after being affixed to the mounting surface. Test your contact sensor, reed switch and magnet location before affixing the device to the surface. Use masking or painters tape to secure the contact sensor, reed switch and magnet to the surface (align the magnet with reed switch). Once you have the contact sensor, reed switch and magnet temporarily mounted, test it out. With the app in hand, open or close the door while observing the status of the contact sensor as shown on the app (Opened or Closed). Optionally, you may set up your automation (e.g. turn on a light when the door is opened) to functionally test the status change of the door or window - proceed to the following steps for information on creating automations, then return to this step
- Be sure the installing gap between sensor and magnet is within 0.7 inch and the magnet is aligned with the internal magnetic reed switch when door or window is closed, otherwise the sensor may cannot obtain the correct status of door or window
- Avoid allowing the sensor to be exposed to strong impacts or vibration, contact sensor should be mounted on the fixed part of door or window (such as the frame of a door or a window, etc.) , while magnet should be mounted on the movable part of door or window
- Avoid interference, install the contact sensor away from any strong magnetic object
- Please add the Contact Sensor to the YoLink app before installation
- Refer to “Install or Replace the Batteries” section on page 26 for the installation of batteries for the contact sensor

⚠ Skip to page 10 for monitoring contact closure type devices/equipment

These Tools may be Required

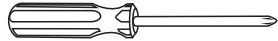

Phillips Screwdriver

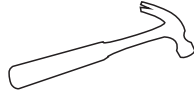

Hammer

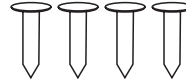

Nail (4)

OR



Double-sided
Mounting Tape (2)

Reed Switch and Magnet Installation

- Use screws (you can also use nails or double-sided mounting tape instead) to mount the reed switch and magnet to the different sides of a door or window or gate (*place the reed switch to the fixed part of your door or window or gate*)

D.

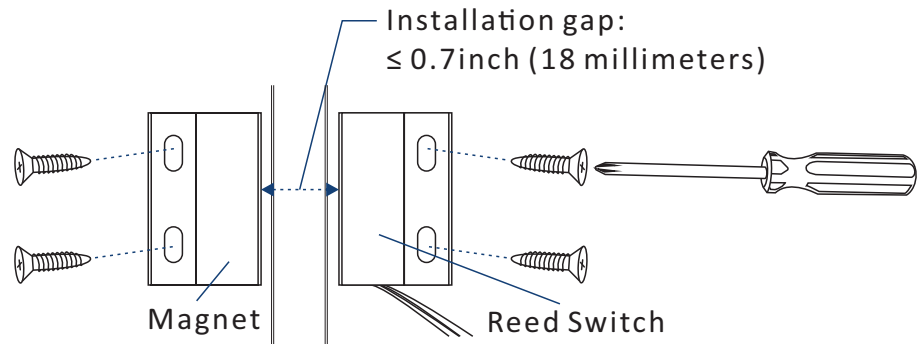

* If you choose to mount the reed switch and magnet using double-sided tape, you will need to clean the installation area first and press firmly for at least 5 seconds after being installed in the desired position

Contact Sensor Installation Methods

- Method A: Place anywhere

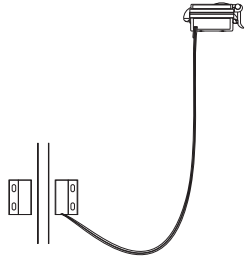

- Method B: Wall-mounting the sensor

- Clean the installation area
- Remove one side of the protective layer from the double-sided tape, stick the double-sided tape on the back of the contact sensor
- Remove the other side of the protective layer from the double-sided tape on the back of the contact sensor, place the contact sensor in the desired position, and press firmly for at least 5 seconds



- 1 Clean the area

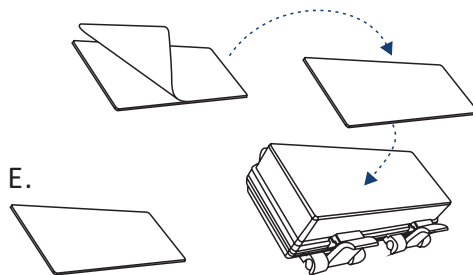

- 2 Stick the double-sided tape on the back of the contact sensor

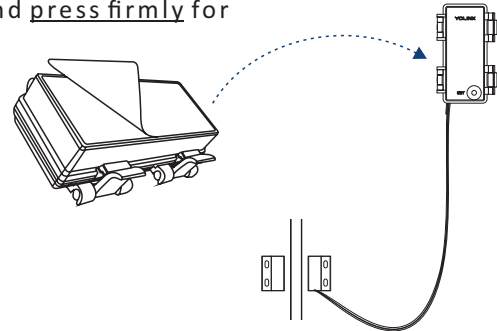

- 3 Remove the protective layer, stick and press for 5 seconds

Contact Closure Device/Equipment Installation

These Tools may be Required

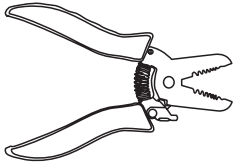

Wire Cutter/Stripper

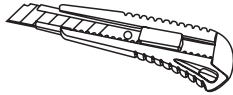

Utility Knife

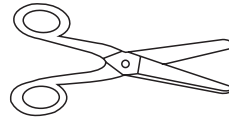

Scissors



Phillips screwdriver



Extra small straight
screwdriver



Wire Nuts
/Connectors (2)



Electrical Tape

Note

- Your contact closure type device must be functional and de-energized/disconnected from other equipment (see page 2 for additional information on compatible contacts)
- Install the sensor batteries after installation
- Wire nuts (twist-on connectors) are the recommended wire splicing method. Other methods may be acceptable as long as they provide a secure electrical connection, with no exposed conductors

Get Ready

- If your device has screw terminals for wiring connections, proceed to the next page. Otherwise, using a wire stripper, remove the insulation on each conductor of alarm contact of the contact closure output device, leaving roughly half an inch of exposed conductor

Begin Installation

- Use a wire cutter tool to remove the reed switch from the connector cable (*take good care of the reed switch and magnet - store for future use, as needed*)
- Using a wire stripper, remove the insulation on each conductor, leaving roughly half an inch of exposed conductor

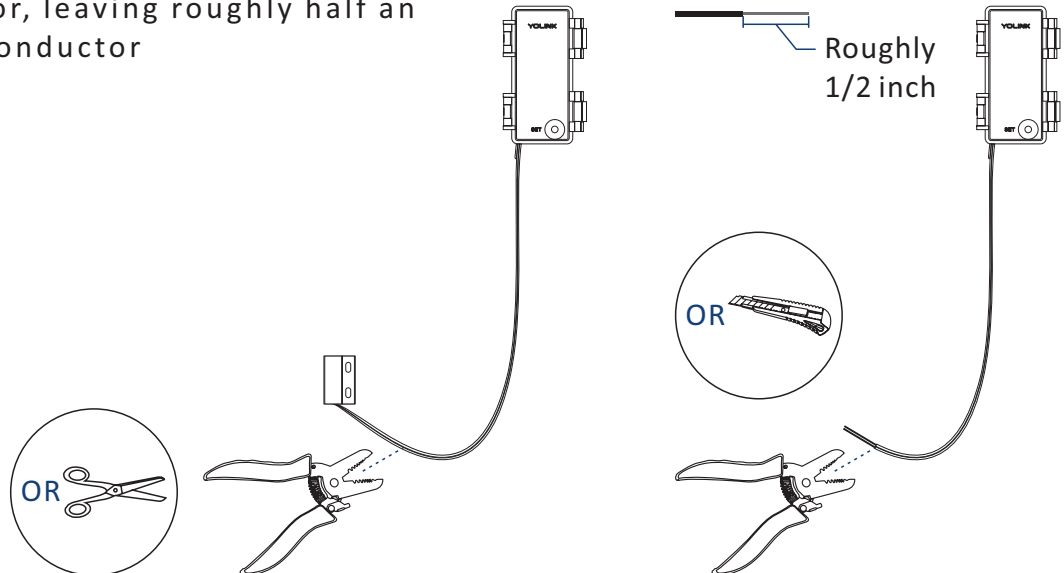

- If connecting to device/equipment with screw type terminals or direct connections, connect each conductor to the appropriate screw terminal/connector on the device. The screw terminals may be labeled "common" and "normally closed" (refer to the device's installation manual for more information)
- For devices with "pigtail" or wiring connections, connect the sensor cable to the device wires utilizing wire nuts or other suitable electrical splicing connector. Using a wire nut, twist the wire from the contact sensor together with the wire on the contact closure output device, do the same for the other wire (no positive and negative difference between the wires)
- Ensure there are no exposed wire conductors (visible copper). If so, redo the connections. You may optionally wrap the splices with electrical tape
- Refer to "Install or Replace the Batteries" section on page 26 for the installation of batteries for the contact sensor
- Refer to page 9 for sensor installation instruction
- Test the contact sensor by changing the open/closed state of the monitored door, window or device/equipment. Use the YoLink app to observe the status of the contact sensor (Open or Closed)

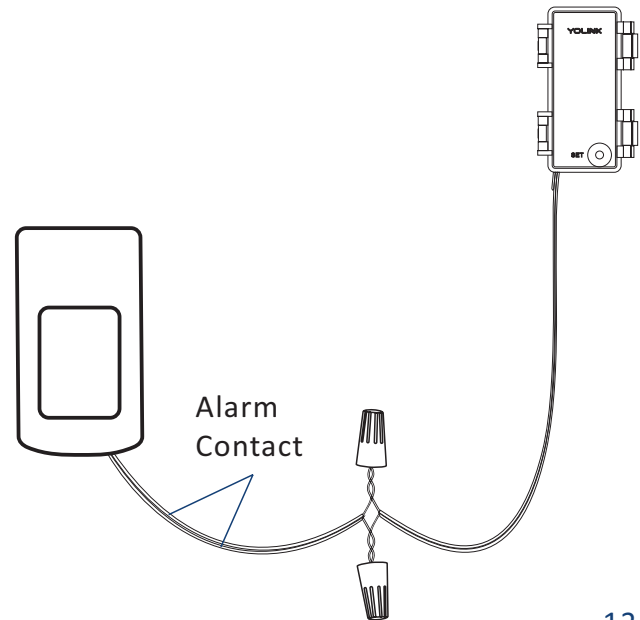

Using the YoLink App

Device page

Device name

** Edit name on Details page*

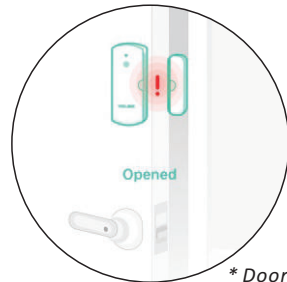

** Door/gate/window/contact closure output device is opened*

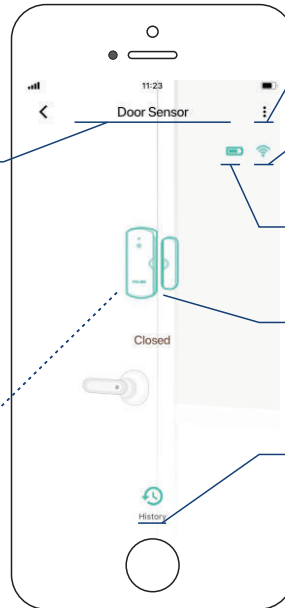

Details

** Tap to go to Details page (refer to page 14)*

Connection status

of sensor and Hub

Current Battery level

** Shown red if replacement is required*

Real-time status:

Door/gate/window/contact closure output device is open or closed

Device history

Door/gate/window/contact closure output device opened and closed, logged with date & time

Details page

Device type

Rename the device

Choose a room
for device

Add / remove
from favorites

Device history

Door/window opened
and closed, logged with
date & time

Alert settings

** Enable or disable alerts.
Default is set to Alert When
Door/Window is Opened or
Closed*

Send notification

to you when the
door/window is left
open for a set time
** Default is set to 20 seconds*

Device status

Opened or closed

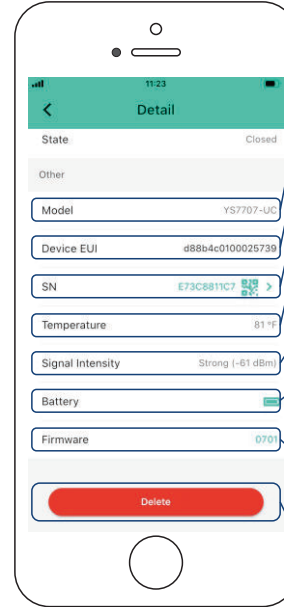
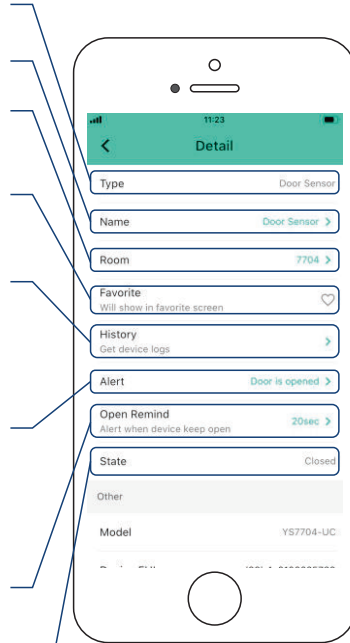

Device model

Device EUI (unique)

Device SN (unique)

Temperature value

** Refreshes when:*
1. SET button pressed
2. On a device alert
3. Batteries are replaced
4. Automatically within 4 hours
maximum

Connection status
of sensor and Hub

Battery level

current battery level
** Shown red if replacement is
required*

Firmware version

** "#### ready now" indicates a
new update is available (refer
to page 24)*

** Tap to delete the device from
your YoLink account*

** After changing "Open Remind" settings, press the device's SET button once, to sync the new settings to the device. Otherwise, the device will automatically update within 4 hours (maximum)*

Device Alerts

- Upon the opening or closing or left open for a set time of the door/gate/window/contact closure output device, an alert will be sent to your YoLink account

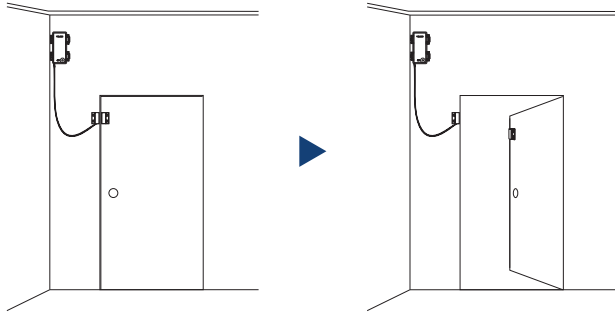

Door is opened

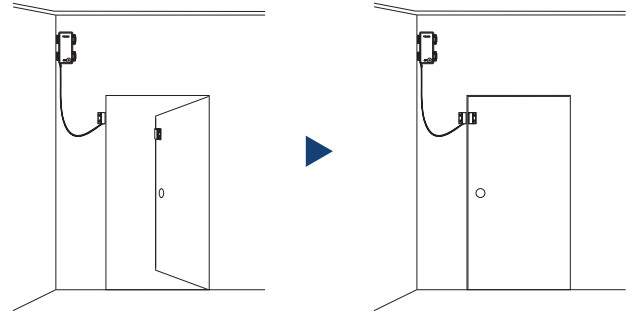

Door is closed

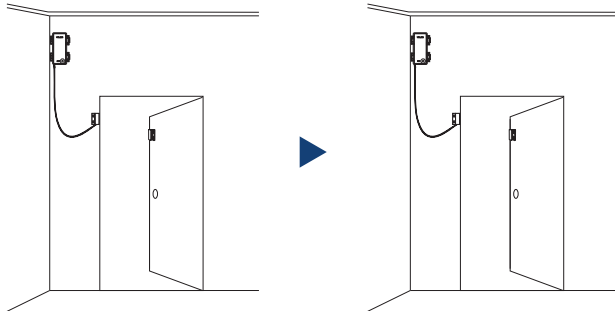

Door is still open (for a set time)

Automation

Easily set up rules for “if this then do that” functions

- Go to “Smart”, tap “Automation” followed by the “ + ” icon to add an automation
- Fill in details followed by the “ ✓ ” icon

** Contact Sensor can be set as a trigger only*

Tap to add an automation

Tap “  ” button to enable or disable the automation

** Click to edit the automation.
Swipe left to view the history logs and to edit or delete the automation*

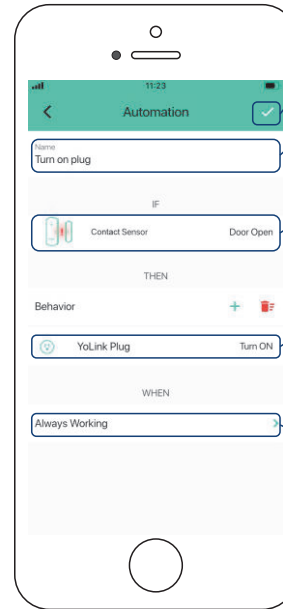
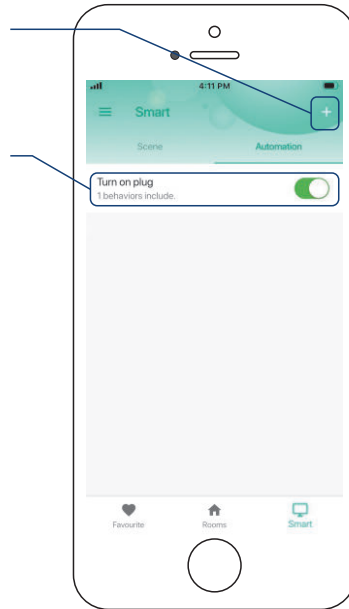
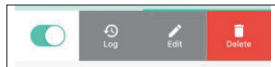

Tap to save the settings

Edit name for the automation

Edit trigger

Edit behavior

** You must have at least one action device, or you cannot set a behavior*

Edit when

** Set a time range for the automation (always or during specific days / times)*

Voice Assistants

Connect YoLink with third-party voice assistants service to monitor the status of your devices through voice commands

- Tap “☰” in the upper left corner to go to My Profile
- Go to **Settings > Voice Assistants** for the applicable voice assistant integration guide

** Contact Sensor is integrated with Alexa and Google Assistant, and is also integrated with [IFTTT.com](https://ifttt.com), works as trigger event pipelines using IFTTT*

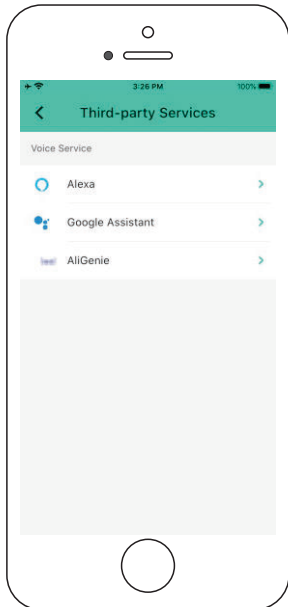

About YoLink *Control*

YoLink *Control* is our unique device-to-device control technology. Using YoLink *Control*, YoLink devices can be controlled without the Hub or an internet connection. (Use of YoLink *Control* is optional; you can use the Automation feature in the app OR use YoLink *Control*, but YoLink *Control* offers the benefit of operation without the Hub or internet connection.)

One device controls another, directly. A device that sends out commands is called the controller. A device that receives the commands is called the responder. Examples of a controller are a Contact Sensor or Water Leak Sensor, while examples of a responder are a Siren or a YoLink Plug Mini

The Contact Sensor can only work as the controller in YoLink *Control*

Pairing

- To configure your Outdoor Contact Sensor as a controller, first ensure the door/gate/window is in the open position, or the connected contacts are in the opened state. Press and hold the SET button for 5-10 seconds until the LED quickly blinks green
- To configure a YoLink Plug Mini as the responder. Turn on the plug using POWER button or via YoLink app (verify the Status LED of YoLink Plug Mini displays blue). Press and hold the POWER button for 5-10 seconds until the LED quickly blinks blue
- Upon pairing, the LED will stop blinking (this may happen after only blinking two or three times)

Note

- If you want to turn off the YoLink Plug Mini when the door is opened, turn off the YoLink Plug Mini first, and let it enter pairing mode
- For the same Contact Sensor and YoLink Plug Mini, you can only choose to either turn on or turn off the YoLink Plug Mini when the door is opened
- If you want to turn on or off the YoLink Plug Mini when the door is closed, first ensure the door/gate/window is in the closed position, or the connected contacts are in the closed state before placing the sensor into pairing mode
- Also for the same Contact Sensor and YoLink Plug Mini, you can only choose to either turn on or turn off the YoLink Plug Mini when the door is closed

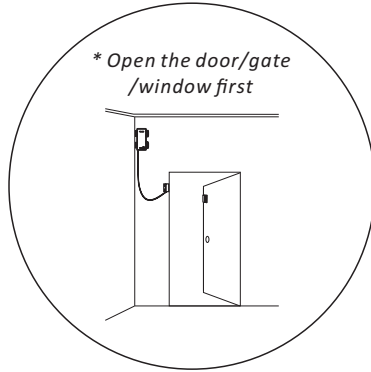

Turn on the plug

* verify the Status LED of YoLink Plug Mini displays blue. Refer to the YoLink Plug Mini manual for more information:



YS6604-UC_YoLink Plug Mini

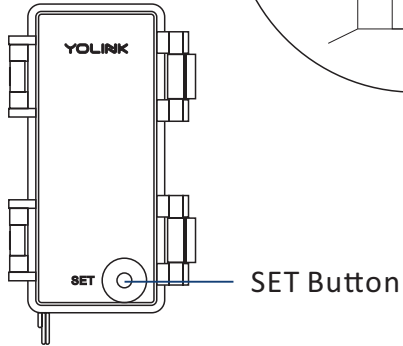

Hold the SET button for 5-10 seconds, until the green light blinks quickly

1

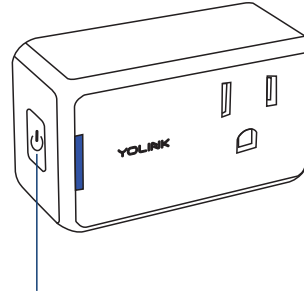

Hold the POWER button on the YoLink Plug Mini (**Turned on**) for 5-10 seconds, until the blue light blinks quickly

2

Operation

- When the door is opened, the YoLink Plug Mini will now immediately turn on. The plug will remain turned on until turned off using the POWER button or via the app
- More advanced sequences, controlling multiple outputs (e.g. turn off plug and activate siren) are available via the YoLink app

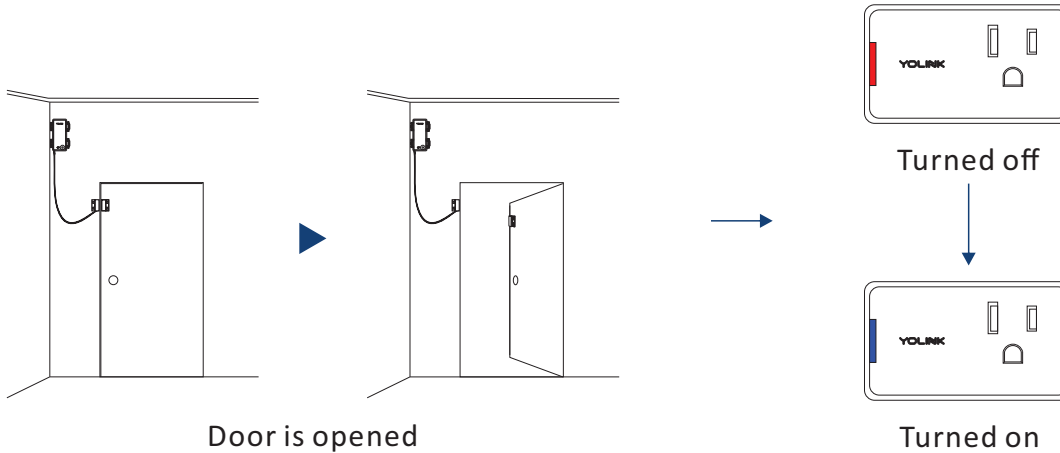

Unpairing

- At the Contact Sensor (controller), open the connected door, window or gate, then press and hold the SET button for 10-15 seconds until the LED quickly blinks green, then red
- At the YoLink Plug Mini (responder), press and hold the POWER button for 10-15 seconds, until the LED quickly blinks blue, then red
- Upon un-pairing, the Contact Sensor LED will stop blinking and turn off, and the YoLink Plug Mini LED will stop blinking and return to the previous color (blue for turned on, red for turned off)
- The YoLink Plug Mini will no longer respond when the door is opened

Note

- If you want to unpair the Contact Sensor (closed status) with the YoLink Plug Mini, turn the sensor into closed status (verify the door/gate/window is closed), and let it enter unpairing mode

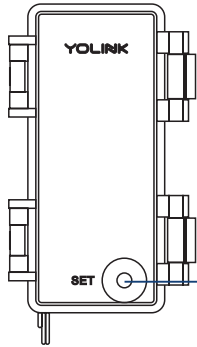
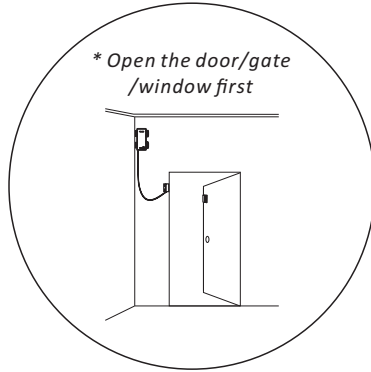

SET Button

Hold the SET button for 10-15 seconds, until the red light blinks quickly

1

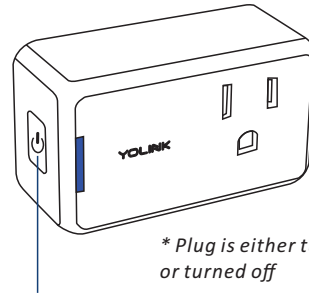

* Plug is either turned on or turned off

POWER Button

Hold the POWER button on the YoLink Plug Mini for 10-15 seconds, until the red light blinks quickly

2

Maintenance

Firmware Update

To ensure our customers have the best user experience, we highly recommend you update to the newest version firmware when an update is available

- In “Firmware”, if a new version is listed as available (#### ready now), click it to start the firmware update process
- The device's firmware will be updated automatically within 4 hours (maximum). To force an immediate update, press the SET button on the device once to make the device enter update mode
- You may use your device during the update as it is performed in the background. The LED light will slowly blink green during the update and the process will be complete within 2 minutes after the light stops blinking

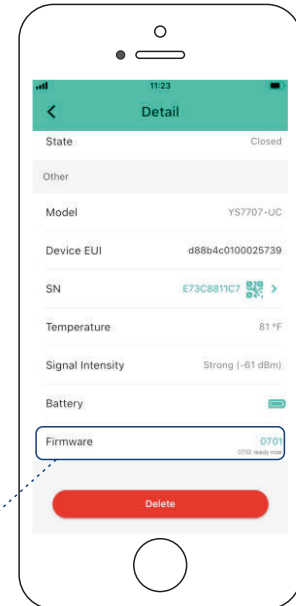

Factory Reset

Factory reset will erase all of your settings and restore it to factory defaults. After the factory reset, your device will remain in your Yolink account

- Hold the SET button for 20-25 seconds until the status light blinks red and green alternately, then, release the button (*Hold the SET button longer than 25 seconds will ABORT the factory reset operation*)
- Factory reset will be complete when the status light stops blinking

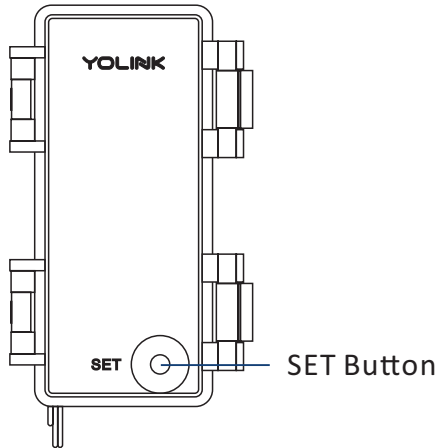

Install or Replace the Batteries

- With a lifting/prying action on the two clamp latches, open the cover on the sensor (due to the waterproof design, this step may be slightly difficult)
- Install two new alkaline non-rechargeable AA batteries, and then close the two clamps of the sensor
- Using the app, check the online status of the sensor and verify there is no low-battery indicator
- Note: do not mix old and new batteries

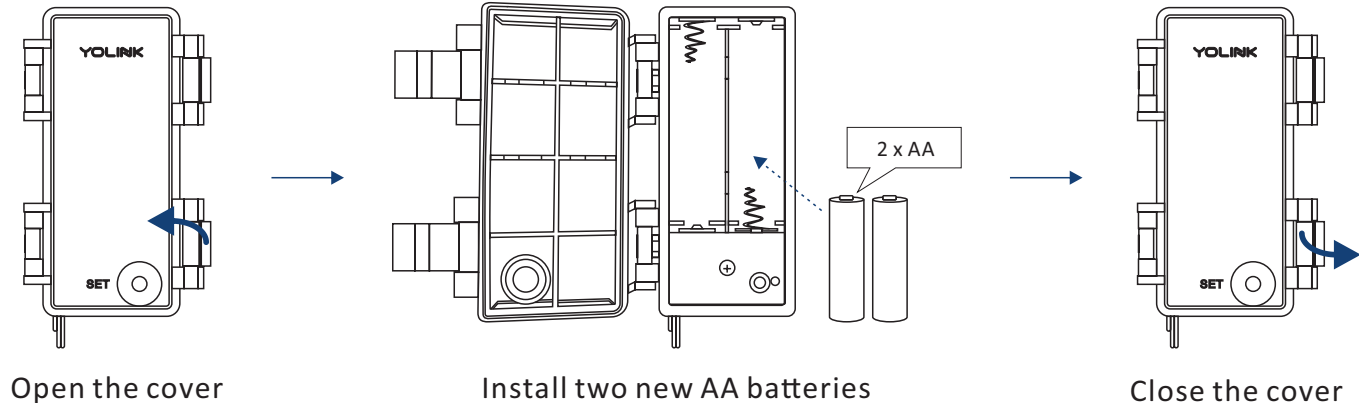

Specifications

Voltage: 3V DC (2 - Alkaline Non-Rechargeable AA Batteries)

Magnet Gap: ≤ 0.7 inch (18 millimeters)

Reed Switch Type: NC (Normal closed type)

IP Rating: IP63 (Waterproof)

Environment: Temperature: -4°F - 122°F (-20°C - 50°C)
(Indoor/Outdoor use) Humidity: < 95%RH non-condensing

Dimensions:

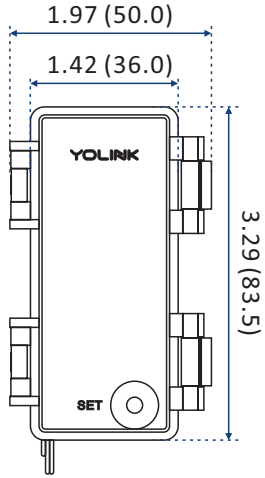

FRONT

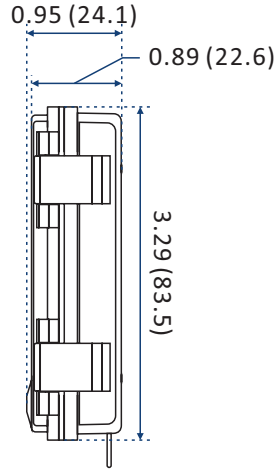

SIDE

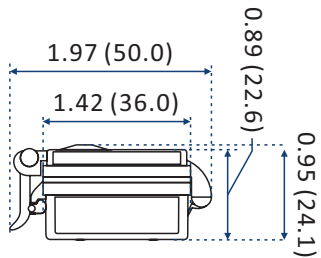

TOP

Length of Connection Cable:
Roughly 13 inches (33 centimeters)

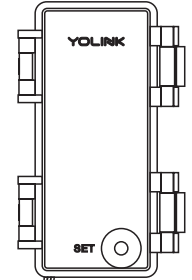
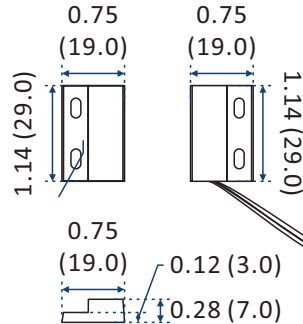

Troubleshooting

Hardware:

Batteries: Batteries should be brand new, name brand “AA” alkaline type. Refer to “Warnings” Section on page 30

Function:

1. Device is offline

- If sensor is not connected to the cloud, press the SET button on contact sensor once
- If Hub is offline, reconnect the Hub to the Internet and press the SET button on contact sensor once
- If Hub is not on, power on the Hub again and press the SET button on contact sensor once
- If sensor is out of range with Hub, relocating the sensor or Hub may be required
- For a device with low-battery indicators or alerts or if the condition of the batteries is in question, replace the batteries with 2 premium “AA” alkaline batteries

2. Other issues, contact customer service, **1-949-825-5958 (M-F 9am - 5pm PST)**

Warning

- Please install, operate and maintain the Contact Sensor only as outlined in this manual. Improper use may damage the unit and/or void the warranty
- Do not install or use the sensor outside of the temperature and humidity range listed in the Environmental section in Specifications, on page 27. Lithium non-rechargeable batteries, operating in a wider temperature range, are recommended for applications on the hotter or colder end of the device's operating range (device environmental limitation can be extended to the range of -4°F - 176°F (-20°C - 80°C))
- While the sensor is waterproof, to ensure optimal operation and lifetime of the sensor, installing the sensor with overhead protection from weather is suggested. Do not immerse the sensor or allow it to be immersed in water
- Do not install or use the sensor where it will be subjected to extreme high temperatures and/or open flame
- If your Contact Sensor does get dirty, please clean it by wiping it down with a clean, dry cloth. Do not use strong chemicals or detergents, which may discolor or damage the exterior and/or damage the electronics, voiding the warranty
- Do not install or use the sensor where it will be subjected to physical impacts and/or strong vibration. Physical damage is not covered by the warranty
- Power the sensor only with two AA batteries (see below, regarding batteries)
- Use only new, name brand, alkaline non-rechargeable AA batteries
- Do not use rechargeable batteries

- Do not use zinc blend batteries
- Do not mix new and old batteries
- Do not puncture or damage batteries. Leakage can cause harm on skin contact, and is toxic if ingested
- Do not dispose of batteries in fire as they may explode! Please follow local battery disposal procedures
- To avoid damaging the controller, if storing the sensor for an extended period, remove the batteries
- Please contact Customer Service before attempting to repair, disassemble or modify the device, any of which can void the warranty and permanently damage the device

If you have any difficulties installing or using your Contact Sensor, please contact our Customer Service department during business hours:

US Live Tech Support: **1-949-825-5958** M-F 9am - 5pm PST

Email: **service@yosmart.com**

YoSmart Inc. 17165 Von Karman Avenue, Suite 105, Irvine, CA 92614

Warranty 2 Year Limited Electrical Warranty

YoSmart warrants to the original residential user of this product that it will be free from defects in materials and workmanship, under normal use, for 2 years from the date of purchase. User must provide a copy of original purchase receipt. This warranty **does not cover** abuse or misused products or products used in commercial applications. This warranty does not apply to contact sensors that have been improperly installed, modified, put to a use other than designed, or subjected to acts of God (such as floods, lightning, earthquakes, etc.). This warranty is limited to repair or replacement of the contact sensor only at YoSmart's sole discretion. YoSmart will NOT be liable for the cost of installing, removing, nor reinstalling this product, nor direct, indirect, or consequential damages to persons or property resulting from the use of this product. This warranty only covers the cost of replacement parts or replacement units, it does not cover shipping & handling fees

To implement this warranty please give us a call during business hours at 1-949-825-5958, or visit www.yolink.net

Copyright 2020. YoSmart, Inc. All rights reserved

FCC statement

This equipment has been tested and found to comply with the limits for a Class B digital device, pursuant to part 15 of the FCC Rules. These limits are designed to provide reasonable protection against harmful interference in a residential installation. This equipment generates, uses and can radiate radio frequency energy and, if not installed and used in accordance with the instructions, may cause harmful interference to radio communications. However, there is no guarantee that interference will not occur in a particular installation. If this equipment does cause harmful interference to radio or television reception, which can be determined by turning the equipment off and on, the user is encouraged to try to correct the interference by one or more of the following measures:

- Reorient or relocate the receiving antenna
- Increase the separation between the equipment and receiver
- Connect the equipment into an outlet on a circuit different from that to which the receiver is connected
- Consult the dealer or an experienced radio / TV technician for help

This device complies with part 15 of the FCC Rules. Operation is subject to the following two conditions:

- 1) This device may not cause harmful interference
- 2) This device must accept any interference received, including interference that may cause undesired operation. Any changes or modifications not expressly approved by the party responsible for compliance could void the user's authority to operate the equipment

Note: The manufacturer is not responsible for any radio or TV interference caused by unauthorized modifications to this equipment. Such modifications could void the user's authority to operate the equipment.

FCC RF radiation exposure statement

This equipment complies with FCC RF radiation exposure limits set forth for an uncontrolled environment. This device and its antenna must not be co-located or operating in conjunction with any other antenna or transmitter.