

# YOLINK

## User Guide

YS6801- UC/SM - SO301

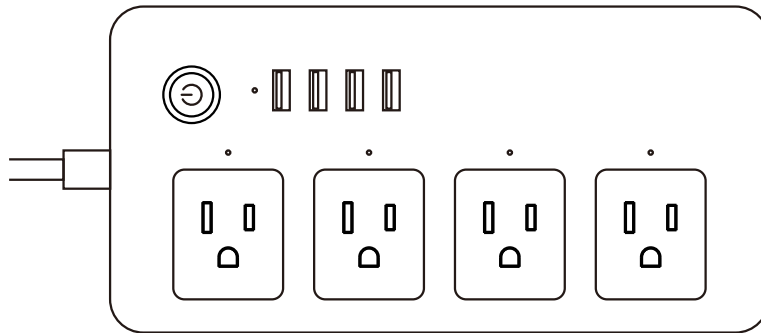
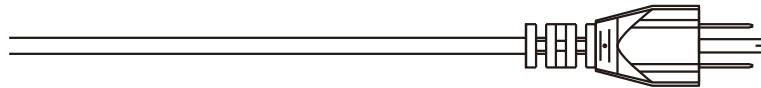

Smart Power Strip

# Contents

Introduction	1
Features	3
Product Requirements	3
Set Up Smart Power Strip	4
Using YoLink App with Smart Power Strip	8
YoLink Control	13
Maintaining the Smart Power Strip	16
Specifications	18
Troubleshooting	19
Customer Service & Warranty	20

# Introduction

With independent control of 4 smart outlets and 4 USB ports, you can easily control lights and home electric devices via YoLink App on your iOS or Android device.

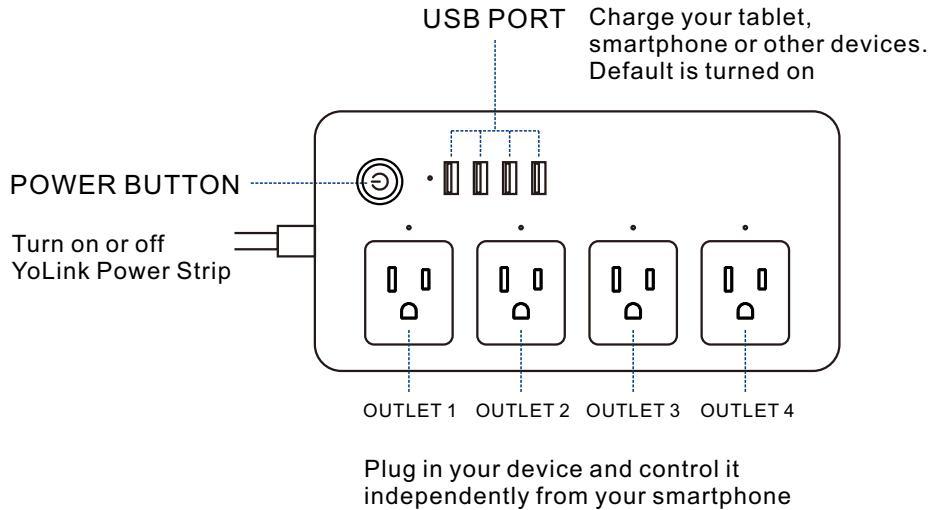

LED lights can show you the current status. See the explanation below:

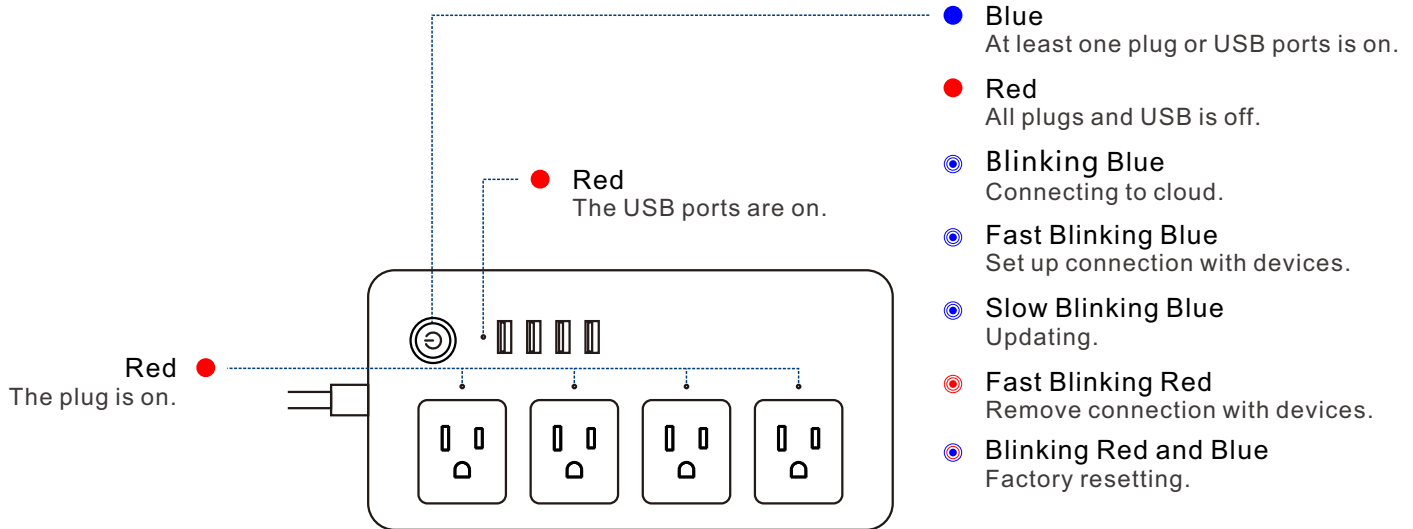

# Features

**Individual Control** - Independently control 4 smart outlets and USB ports via YoLink App on your iOS or Android device.

**Control from anywhere** - Control your Smart Power Strip remotely via YoLink App on your iOS or Android device.

**Timer & Schedule** - Automatically turn on or off household appliance after or at a certain time.

**Scene** - One click control. Tap the scene button to Independently turn on or off 4 smart plugs and action of other devices.

**Automation** - Set up rules for “If this then that” function.

**Voice Control** - Use Alexa or Google Assistant to control your devices with voice commands.

**YoLink Control** - No internet is required, turn on or off your Smart Power Strip when you set up your plug with a YoLink controller.

# Product Requirements

1. A YoLink Hub.
2. A smartphone or tablet running iOS 9 or higher; Android 4.4 or higher.

# Set Up Smart Power Strip

Follow the steps below to set up your Smart Power Strip via YoLink App.

## Step 1: Set up YoLink App

- Get the YoLink App from the Apple App Store or Google Play.



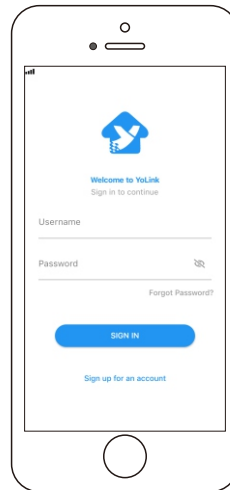

## Step 2: Log in or sign up with YoLink account

- Open the App. Use your YoLink account to log in.
- If you don't have a YoLink account, tap **Sign up for an account** and follow the steps to sign up an account.



## Step 3: Add device to YoLink App

- Tap the “- a. **Name** - Name Smart Power Strip.
- b. **Room** - Choose a room for Smart Power Strip.
- c. **Favourite** - Click “

The diagram illustrates the process of adding a device to the YoLink App. It consists of three smartphone screens and a physical device. The first screen shows the 'Rooms' page with a plus icon highlighted. The second screen shows the 'Add Device' screen with fields for Name, Room, and Favourite, and a 'Bind device' button. The third screen shows the 'Add Device' screen with the 'Bind device' button highlighted. A physical device with a QR code is shown between the first and second screens.



## Step 4: Connect to the cloud

- Plug into an outlet and your device will connect to the cloud automatically.

### Note

- Make sure you hub is connected to internet.

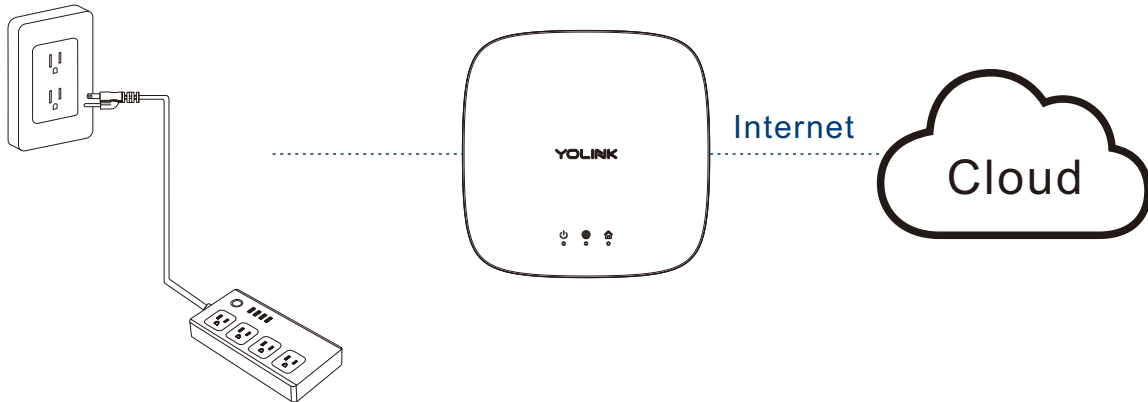

# Using YoLink App with Smart Power Strip

## Details

You can customize the name, set the room, add to/remove from favourite, check device history.

a. **Name** - Name Smart Power Strip or 4 outlets and USB individually.

b. **Room** - Choose a room for Smart Power Strip.

c. **Favourite** - Click “  ” icon to add/remove from Favourite.

d. **History** - Check history log for the Power Strip.

e. **Delete** - The device will be removed from your account.

- Tap the “Smart Power Strip” in App to go to its controls.
- Tap the “  ” icon at the top-right corner to go to details.
- Tap the icon for each of the settings you want to personalize.

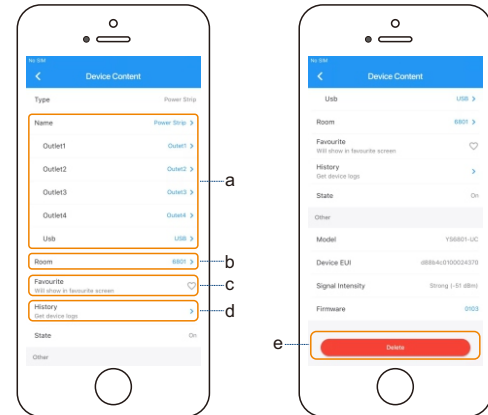

# Timer

With YoLink App, you can set up a timer to turn on or/and off 4 outlets individually.

- Tap the “Smart Power Strip” in App to go to its controls.
- Tap “Timer” for timer setting.
- Choose action from “ON”, “OFF”, or “ON then OFF”.
- Set the timer duration in Hours and Minutes for one or more plugs.
- Tap “ ✓ ” icon to save.

## Note

- One timer will run only once. You can set a new timer after the timer has already run or once you cancel it.
- The timer here is running at device without internet.

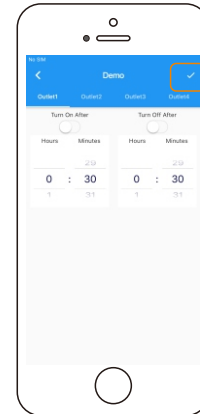

## Schedule

You can create ON/OFF schedules to automate your plugged-in devices to work around your home and work schedules.

- Tap the “Smart Power Strip” in App to go to its controls.
- Tap “Schedule” to open the Schedule screen, tap “ + ” to add a new schedule.
- Within the Add Schedule screen, set the time, your preferred state (“ON”, “OFF” or “ON then OFF”) for the connected device, and repeating frequency.
- Tap “ ✓ ” icon to save.
- Activate or deactivate the schedule at schedule screen.
- Swipe left each schedule to edit or delete it.

### Note

- You can keep maximum 10 schedules at one time.
- The schedule here is running at device without internet.
- You may try to add schedule at Automation where you can add as many as you want. The automation setting is saved in cloud.

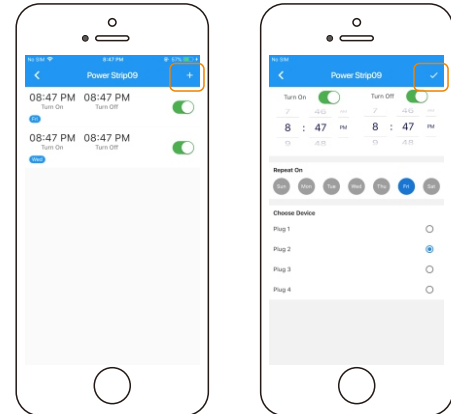

# Scene

Set one-click control for multiple devices in your YoLink App. You only run a scene via your YoLink App.

- Tap “Smart” to switch to Smart Screen.
- Tap “ + ” to create your own Scene.
- To set a Scene, you will be able to put one or more devices under this scene, and define their actions and/or states.
- To execute a Scene, you may tap any scene at “Smart” or “Favourite” if you mark it as favourite.
- Swipe left any Scene order to edit or delete it.

## Note

- You must have at least one YoLink Device in order to create a Scene.

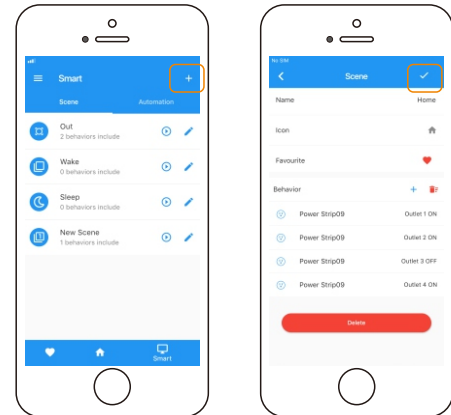

# Automation

Automation allows you to set up “If This Then That” rules so the devices could act automatically.

- Tap “Smart” to switch to Smart screen and tap “Automation”.
- Tap “ + ” to create an automation.
- To set an Automation, you will need to set a trigger time, local weather condition, or choose a device with certain stage as a triggered condition. Then set one or more devices, scenes to be executed.

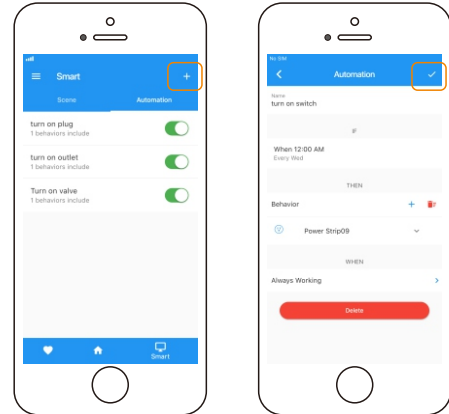

# YoLink Control

YoLink Control is our unique “device to device” control technology. Under YoLink Control, the devices can be controlled without internet or Hub. Devices which send out command is called controller(Master). Devices which receive command and act accordingly is called responder(Receiver). Controller and responder list will show you below.

You will need to set it up physically.

## Controller List

- YS7704-UC Door Sensor
- YS7705-UC Garage Door Sensor
- YS7804-UC Motion Sensor
- YS7903-UC Leak Sensor
- YS3603-UC YoLink Remote
- YS6602-UC YoLink Plug
- YS6604-UC YoLink Plug Mini
- YS5705-UC In-wall Switch
- YS6704-UC In-wall Outlet
- YS6801-UC Smart Power Strip

Continuously updating..

## Responder List

- YS6602-UC YoLink Plug
- YS6604-UC YoLink Plug Mini
- YS5705-UC In-wall Switch
- YS6704-UC In-wall Outlet
- YS6801-UC Smart Power Strip

Continuously updating..

## Pairing

- Find a power strip as controller(Master). Hold the power button for 5-10 seconds, the light will flash blue quickly.
- Find another action device as responder(Receiver). Hold the power/set button for 5-10 seconds, the device will enter pairing mode.
- After pairing succeed, the light will stop flashing.
- When the power strip turns on, the responder will turn on as well. When the power strip turns off, the responder will turn off as well.

## Unpairing

- Find a controller(Master) power strip. Hold the power button for 10-15 seconds, the light will flash red quickly.
- Find a responder(Receiver) action device. Hold the power/set button for 10-15 seconds, the device will enter un-pairing mode.
- The above two devices will unpair by themselves and the light stops flashing.
- After unbundling, When the power strip turns on, the responder will no longer turn on. When the power strip turns off, the responder will no longer turn off.

POWER BUTTON

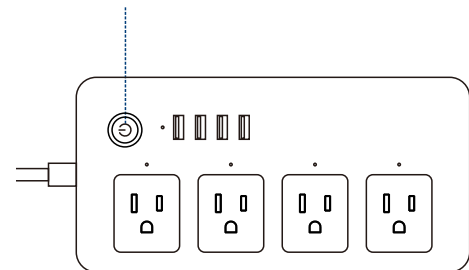



# YoLink Control Diagram

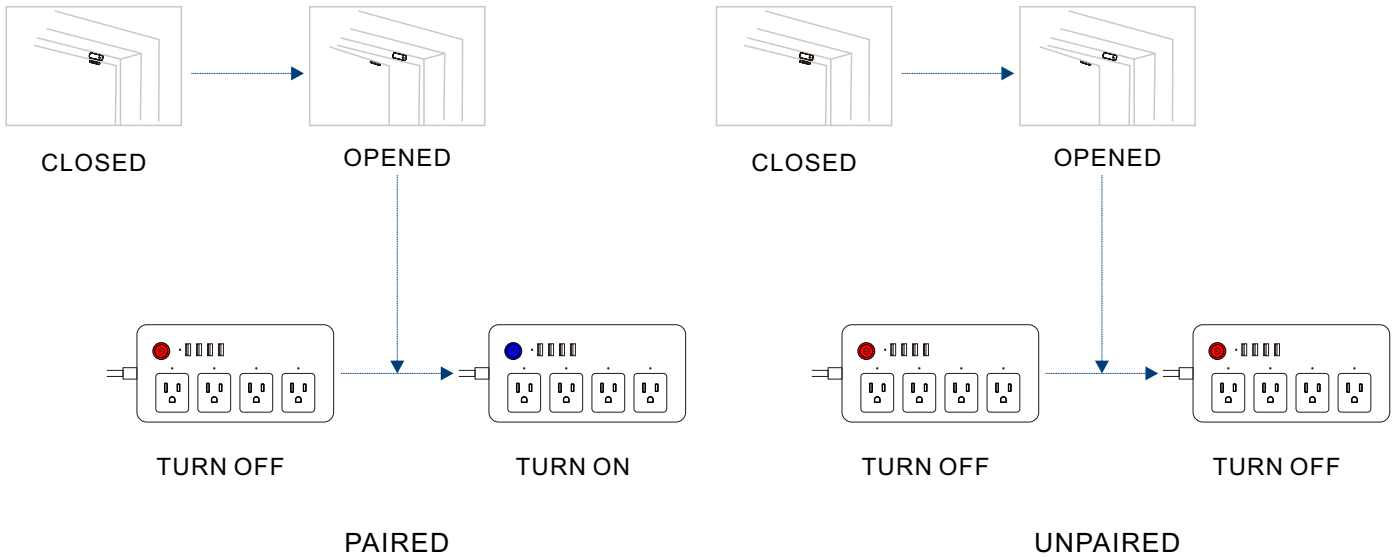

# Maintaining the Smart Power Strip

## Firmware Update

Ensure our customer have the best user experience. Highly recommend you could update our newest version firmware.

- Tap the “Smart Power Strip” in App to go to its controls.
- Tap the “⋮” icon at the top-right corner to go to details.
- Tap “Firmware”.
- The light will be slowly blinking blue during the update and stop blinking when the update done.

### Note

- Only the Smart Power Strip that is currently reachable and has an available update will be shown in the Details screen.

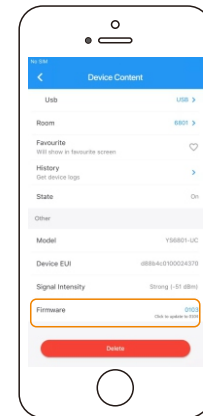

## Factory Reset

Factory reset will erase all your settings and bring it back to default. After the factory reset, your device will still in your Yolink account.

- Hold the power button for 20-25 seconds until the LED blinks red and green alternately.
- Factory reset will be done when the light stops flashing.

POWER BUTTON

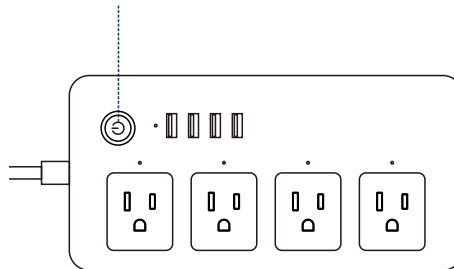

# Specifications

---

Input: 100 ~ 120V AC, 60Hz

---

AC Power Output: 100 ~ 120V AC, 10A MAX (Resistive)

---

USB Power Output: 5V DC, 2.1A

---

Environment: -30°C ~ 70°C (Humidity <90%)

---

# Troubleshooting

Problem	Possible Reason	Solution
Power strip is offline.	Hub is offline.	Please reconnect your hub to the Internet and press the power button of the power strip once.
	Hub is powered off.	Please power on the hub again and press the power button of the power strip once.
	Power strip does not power on.	Please power on the power strip.
	Product defective.	Please contact customer service.
Timer does not run.	There was a power blackout before timer executes.	Please press the power button once to turn on/off the power strip, also you can turn on/off the power strip via YoLink App or set a new timer.
Other problems.	Product defective.	Please contact customer service.

**If you are unable to get your power strip working  
Please contact Our Customer Service during business hours**

US Live Tech Support: 1-844-292-1947 M-F 9am - 5pm PST

Email: [support@YoSmart.com](mailto:support@YoSmart.com)

YoSmart Inc. 17165 Von Karman Avenue, Suite 105, Irvine, CA 92614

**WARRANTY** 1 Year Limited Electrical Warranty

YoSmart warrants to the original residential user of this product that it will be free from defects in materials and workmanship, under normal use, for 1 year from the date of purchase. User must provide a copy of original purchase receipt. This warranty Does Not Cover abuse or misused products or products used in commercial applications. This warranty does not apply to power strips that have been improperly installed, modified, put to a use other than designed, or subjected to acts of God (such as floods, lightning, earthquakes, etc.). This warranty is limited to repairing or replacing of this power strip only at YoSmart's sole discretion. YoSmart will NOT be liable for the cost of installing, removing, nor reinstalling this product, nor direct, indirect, or consequential damages to persons or property resulting from the use of this product. This warranty only covers the cost of replacement parts or replacement units, it does not cover shipping & handling fees.

To implement this warranty please give us a call during business hours at 1-844-292-1947, or visit [www.yosmart.com](http://www.yosmart.com).

REV1.0 Copyright 2019. YoSmart, Inc. All rights reserved.

## FCC Statement

This equipment has been tested and found to comply with the limits for a Class B digital device, pursuant to part 15 of the FCC Rules. These limits are designed to provide reasonable protection against harmful interference in a residential installation. This equipment generates, uses and can radiate radio frequency energy and, if not installed and used in accordance with the instructions, may cause harmful interference to radio communications. However, there is no guarantee that interference will not occur in a particular installation. If this equipment does cause harmful interference to radio or television reception, which can be determined by turning the equipment off and on, the user is encouraged to try to correct the interference by one or more of the following measures:

- Reorient or relocate the receiving antenna.
- Increase the separation between the equipment and receiver.
- Connect the equipment into an outlet on a circuit different from that to which the receiver is connected.
- Consult the dealer or an experienced radio / TV technician for help.

This device complies with part 15 of the FCC Rules. Operation is subject to the following two conditions:

- 1) This device may not cause harmful interference.
- 2) This device must accept any interference received, including interference that may cause undesired operation. Any changes or modifications not expressly approved by the party responsible for compliance could void the user's authority to operate the equipment.

Note: The manufacturer is not responsible for any radio or TV interference caused by unauthorized modifications to this equipment. Such modifications could void the user's authority to operate the equipment.

## FCC RF Radiation Exposure Statement

This equipment complies with FCC RF radiation exposure limits set forth for an uncontrolled environment. This device and its antenna must not be co-located or operating in conjunction with any other antenna or transmitter.

“To comply with FCC RF exposure compliance requirements, this grant is applicable to only Mobile Configurations. The antennas used for this transmitter must be installed to provide a separation distance of at least 20 cm from all persons and must not be co-located or operating in conjunction with any other antenna or transmitter.”