

Contents

- 1: Antenna Overview & Dimension
- 2: The test project
 1. Antenna Matching Network
 2. Gain & Efficiency
 3. The Free Space 3D Data

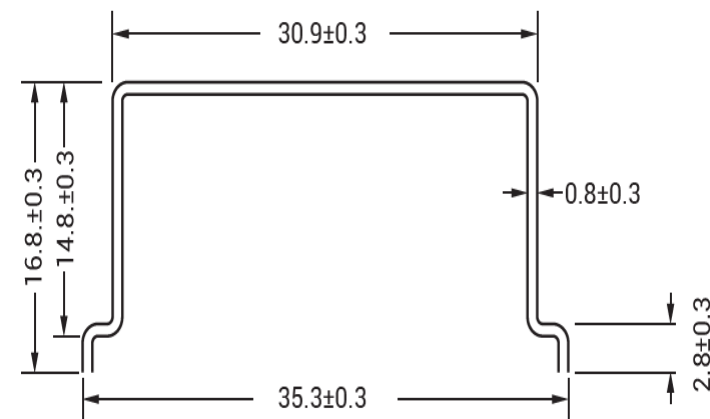

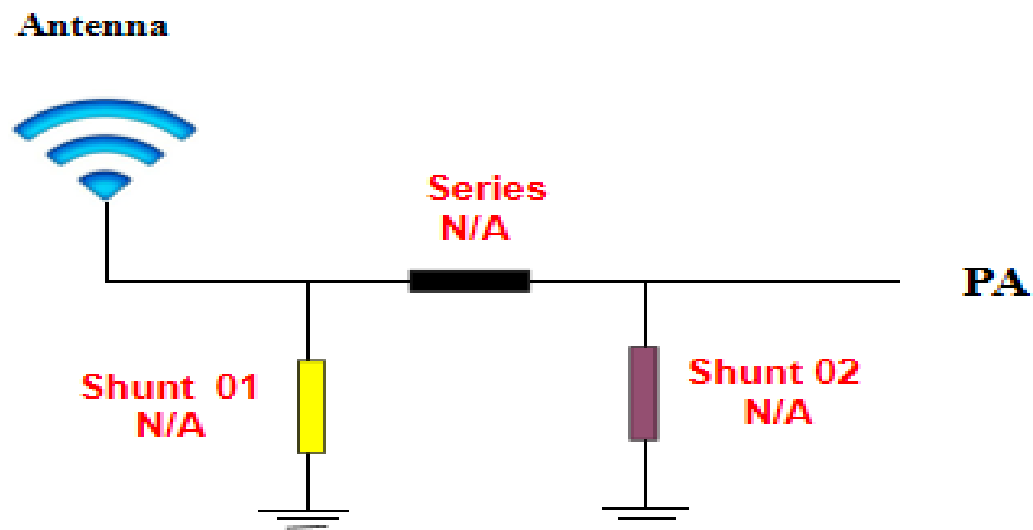

Location	Description
Shunt 01	N/A
Series	N/A
Shunt 02	N/A

Frequency ID	1	2	3	4	5	6	7	8	9	10	11	12	13	14	15
Frequency (MHz)	800.0	805.0	810.0	815.0	820.0	825.0	830.0	835.0	840.0	845.0	850.0	855.0	860.0	865.0	870.0
Efficiency (dBi)	-9.06	-8.88	-8.73	-8.49	-8.20	-7.91	-7.62	-7.28	-6.97	-6.71	-6.50	-6.32	-6.16	-6.03	-5.95
Gain (dBi)	-4.97	-4.74	-4.63	-4.58	-4.44	-4.34	-4.11	-3.88	-3.66	-3.60	-3.64	-3.43	-3.16	-2.88	-2.66
Efficiency (%)	12.41	12.93	13.41	14.16	15.12	16.17	17.30	18.69	20.07	21.32	22.39	23.32	24.20	24.95	25.40

Frequency ID	16	17	18	19	20	21	22	23	24	25	26	27	28	29	30
Frequency (MHz)	875.0	880.0	885.0	890.0	895.0	900.0	905.0	910.0	915.0	920.0	925.0	930.0	935.0	940.0	945.0
Efficiency (dBi)	-5.87	-5.79	-5.74	-5.65	-5.48	-5.33	-5.20	-5.07	-4.93	-4.79	-4.67	-4.62	-4.54	-4.43	-4.37
Gain (dBi)	-2.48	-2.28	-2.20	-2.14	-1.95	-1.85	-1.80	-1.71	-1.63	-1.51	-1.43	-1.33	-1.22	-1.03	-0.89
Efficiency (%)	25.86	26.39	26.65	27.22	28.31	29.33	30.20	31.13	32.14	33.20	34.10	34.48	35.17	36.10	36.55

Frequency ID	31	32	33	34	35	36	37								
Frequency (MHz)	950.0	955.0	960.0	965.0	970.0	975.0	980.0								
Efficiency (dBi)	-4.40	-4.41	-4.39	-4.40	-4.45	-4.50	-4.50								
Gain (dBi)	-0.81	-0.72	-0.58	-0.52	-0.46	-0.48	-0.48								
Efficiency (%)	36.34	36.23	36.36	36.28	35.89	35.46	35.45								

825.0MHz H+V, Eff: 16.2%

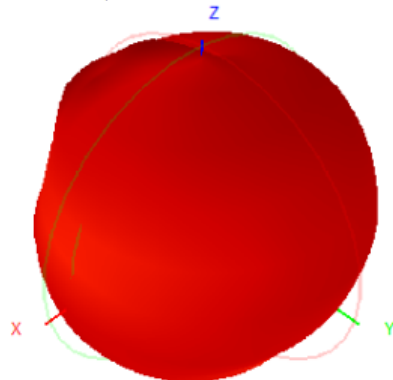

Back View

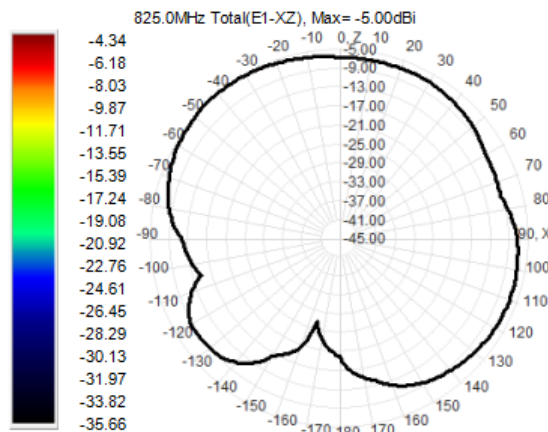
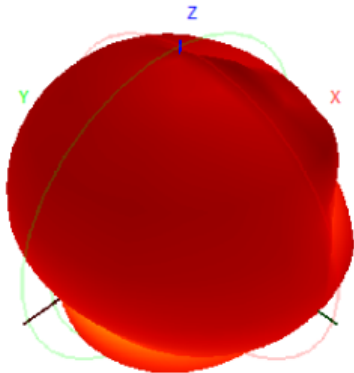

825.0MHz Total(E2-YZ), Max=-5.54dBi

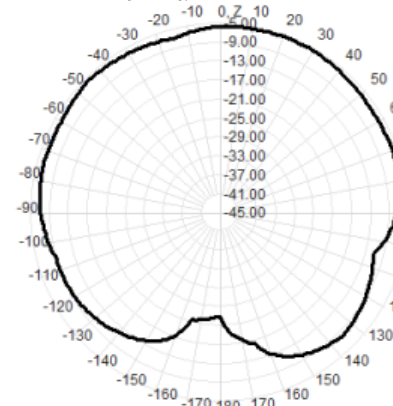

Total(H-XY), Max=-6.05dBi, CirD=5.72

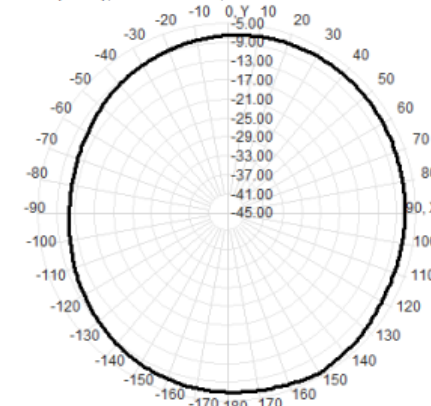

900.0MHz H+V, Eff: 29.3%

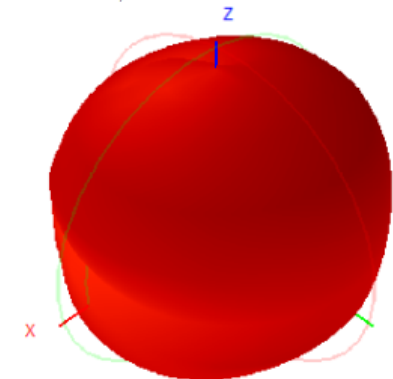

Back View

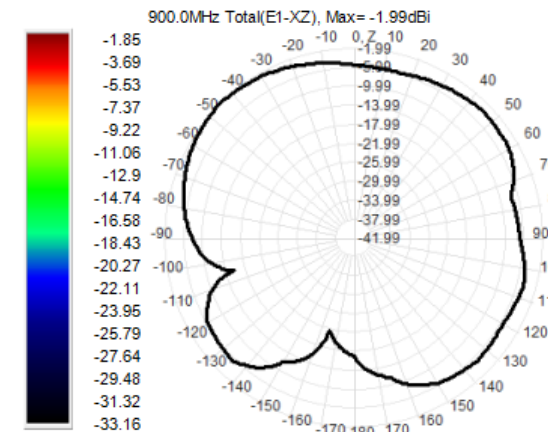
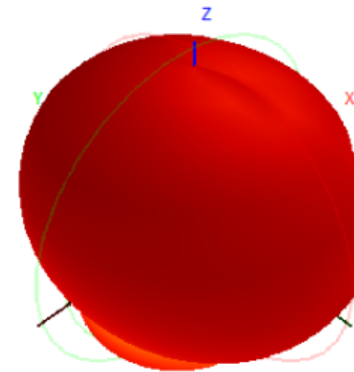

900.0MHz Total(E2-YZ), Max=-2.23dBi

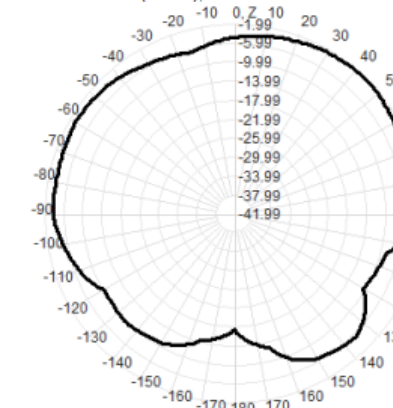

Total(H-XY), Max=-3.36dBi, CirD=4.65

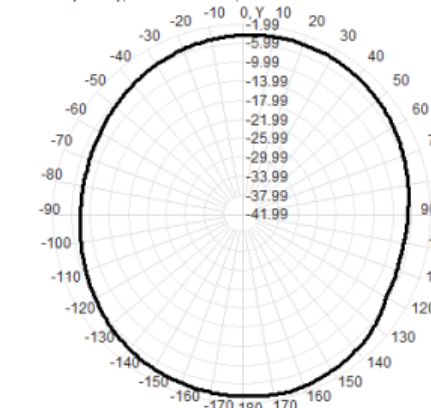

915.0MHz H+V, Eff: 32.1%

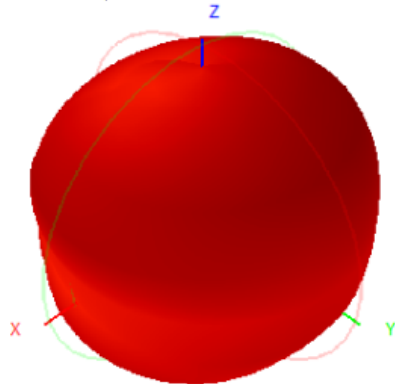

Back View

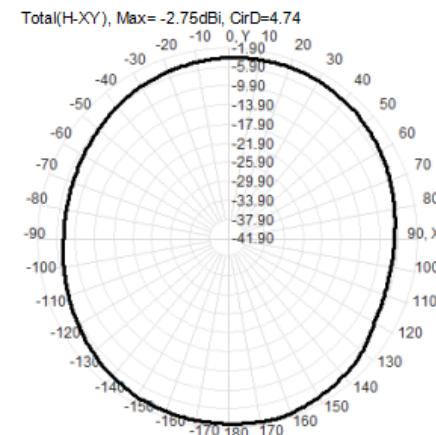
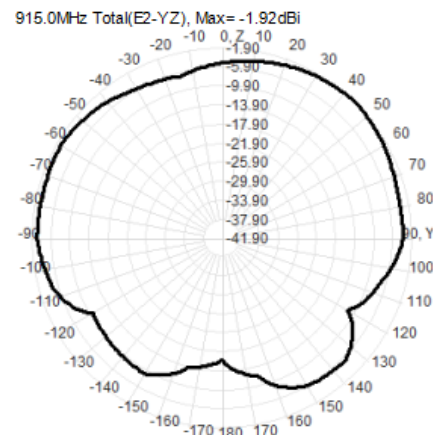
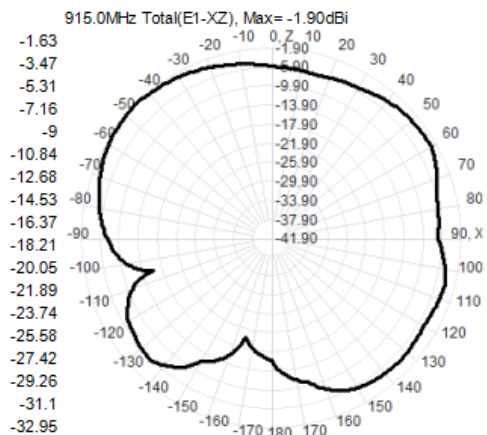
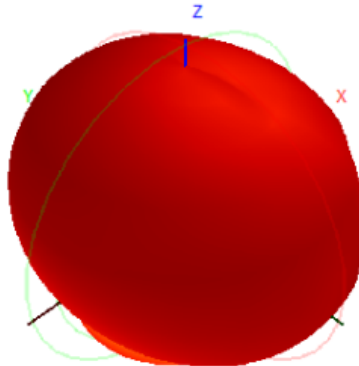

930.0MHz H+V, Eff: 34.5%

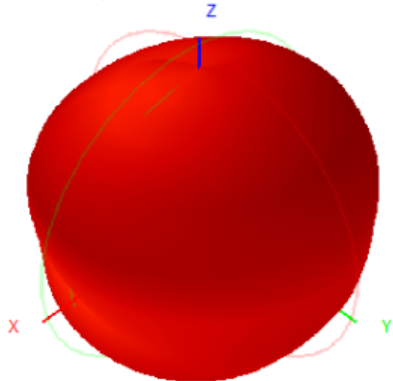

Back View

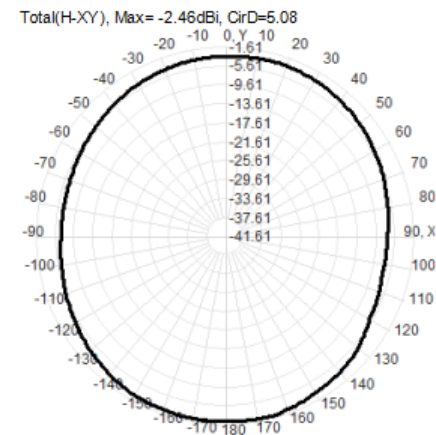
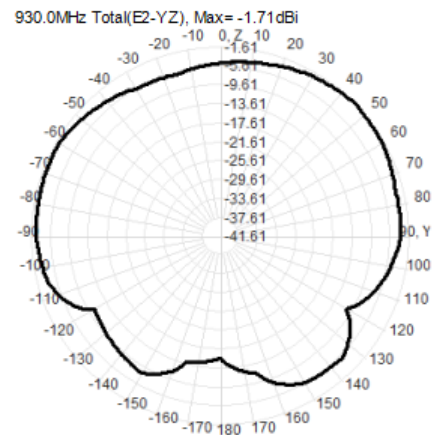
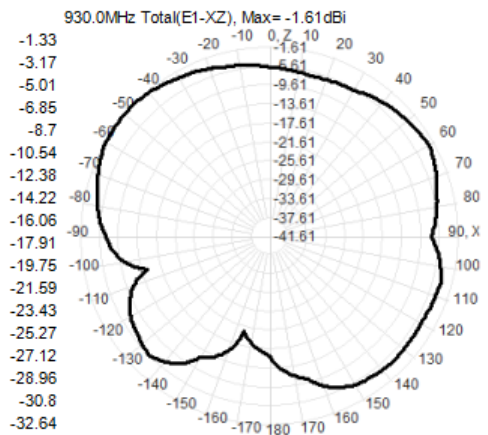
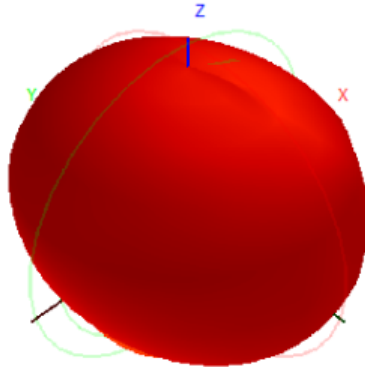

980.0MHz H+V, Eff: 35.5%

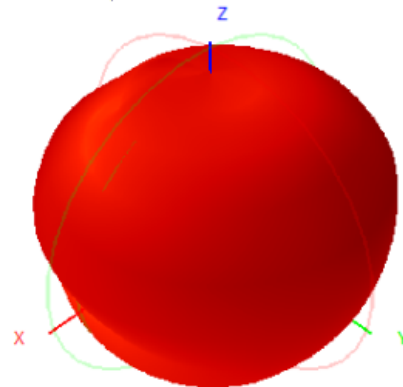

Back View

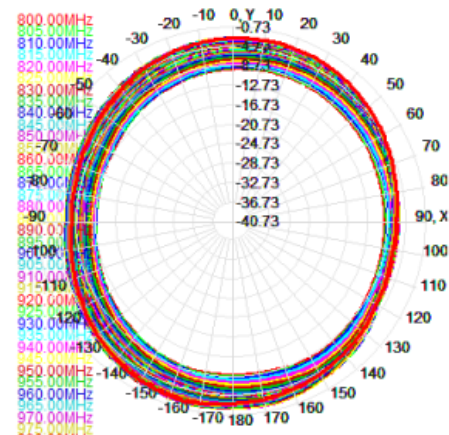
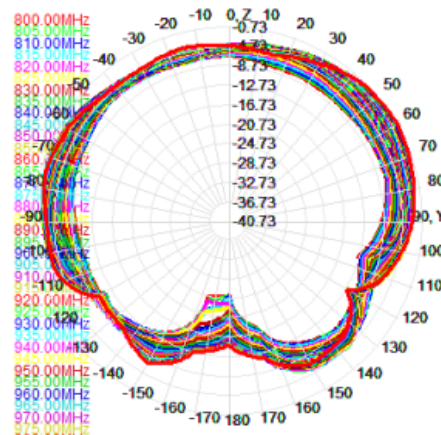
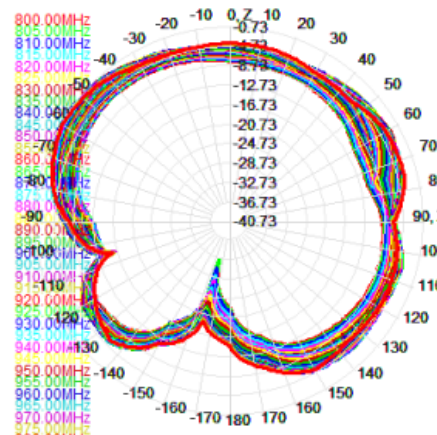
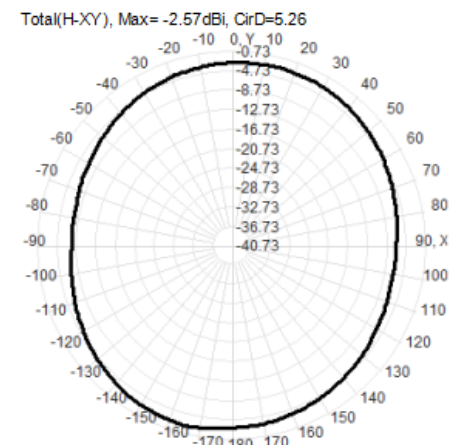
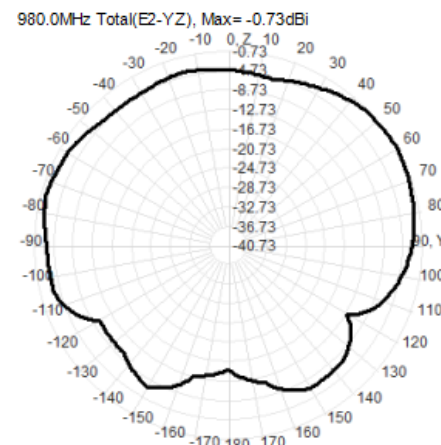
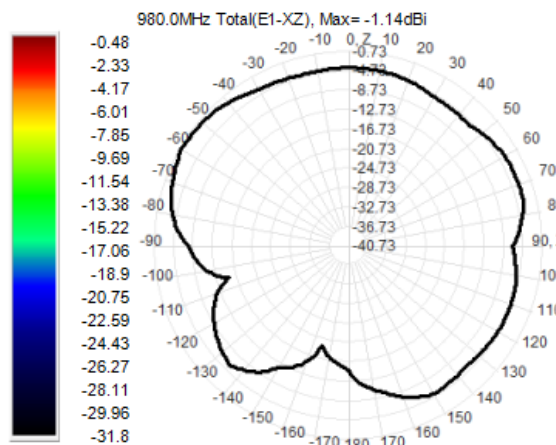
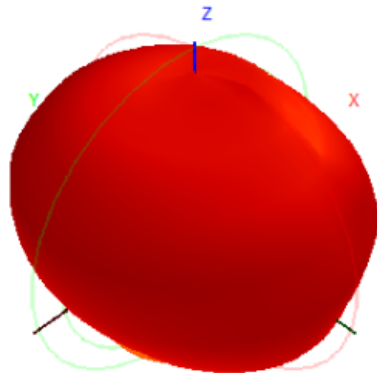

THANKS