

TEST REPORT

Report No.: BCTC2212320957E

Applicant: YoSmart Inc.

Product Name: Motorized valve

Model/Type Ref.: YS5002-UC

Tested Date: 2022-12-02 to 2022-12-27

Issued Date: 2022-12-27

Shenzhen BCTC Testing Co., Ltd.



FCC ID:2ATM75002

Product Name: Motorized valve
Trademark: N/A
Model/Type Ref.: YS5002-UC
YS5002-UA
Prepared For: YoSmart Inc.
Address: 15375 Barranca Parkway, Ste G-105 Irvine, CA 92618, USA
Manufacturer: YoSmart Inc.
Address: 15375 Barranca Parkway, Ste G-105 Irvine, CA 92618, USA
Prepared By: Shenzhen BCTC Testing Co., Ltd.
Address: 1-2/F., Building B, Pengzhou Industrial Park, No.158, Fuyuan 1st Road, Zhancheng, Fuhai Subdistrict, Bao'an District, Shenzhen, Guangdong, China
Sample Received Date: 2022-12-02
Sample tested Date: 2022-12-02 to 2022-12-27
Issue Date: 2022-12-27
Report No.: BCTC2212320957E
Test Standards: FCC Part15.249
ANSI C63.10-2013
Test Results: PASS

Tested by:



Jeff.Fu/Project Handler

Approved by:



Zero Zhou/Reviewer

The test report is effective only with both signature and specialized stamp. This result(s) shown in this report refer only to the sample(s) tested. Without written approval of Shenzhen BCTC Testing Co., Ltd, this report can't be reproduced except in full. The tested sample(s) and the sample information are provided by the client.



Table Of Content

| Test Report Declaration | Page |
|---|------|
| 1. Version | 4 |
| 2. Test Summary | 5 |
| 3. Measurement Uncertainty | 6 |
| 4. Product Information And Test Setup | 7 |
| 4.1 Product Information..... | 7 |
| 4.2 Test Setup Configuration | 7 |
| 4.3 Support Equipment | 7 |
| 4.4 Channel List | 8 |
| 4.5 Test Mode | 8 |
| 5. Test Facility And Test Instrument Used | 9 |
| 5.1 Test Facility..... | 9 |
| 5.2 Test Instrument Used..... | 10 |
| 6. Conducted Emissions | 11 |
| 6.1 Block Diagram Of Test Setup..... | 11 |
| 6.2 Limit | 11 |
| 6.3 Test Procedure | 11 |
| 6.4 EUT Operating Conditions | 12 |
| 6.5 Test Result..... | 12 |
| 7. Radiated Emissions..... | 13 |
| 7.1 Block Diagram Of Test Setup..... | 13 |
| 7.2 Limit | 14 |
| 7.3 Test Procedure | 15 |
| 7.4 EUT Operating Conditions | 16 |
| 7.5 Test Result..... | 17 |
| 7.6 Field Strength Calculation | 21 |
| 8. 100 Khz Bandwidth Of Frequency Band Edge | 22 |
| 8.1 Block Diagram Of Test Setup..... | 22 |
| 8.2 Applicable Standard..... | 22 |
| 8.3 Test Procedure | 22 |
| 8.4 EUT Operating Conditions | 22 |
| 8.5 Test Result..... | 23 |
| 9. 20 Db Bandwidth | 25 |
| 9.1 Block Diagram Of Test Setup..... | 25 |
| 9.2 Limit | 25 |
| 9.3 Test Procedure | 25 |
| 9.4 EUT Operation Conditions | 25 |
| 10. Antenna Requirement | 27 |
| 10.1 Limit | 27 |
| 10.2 Test Result..... | 27 |
| 11. EUT Photographs..... | 28 |
| 12. EUT Test Setup Photographs..... | 29 |

(Note: N/A means not applicable)

BCTC
 3C
 PPR
 检测

1. Version

| Report No. | Issue Date | Description | Approved |
|-----------------|------------|-------------|----------|
| BCTC2212320957E | 2022-12-27 | Original | Valid |
| | | | |

TEC
TC
OVER
檢

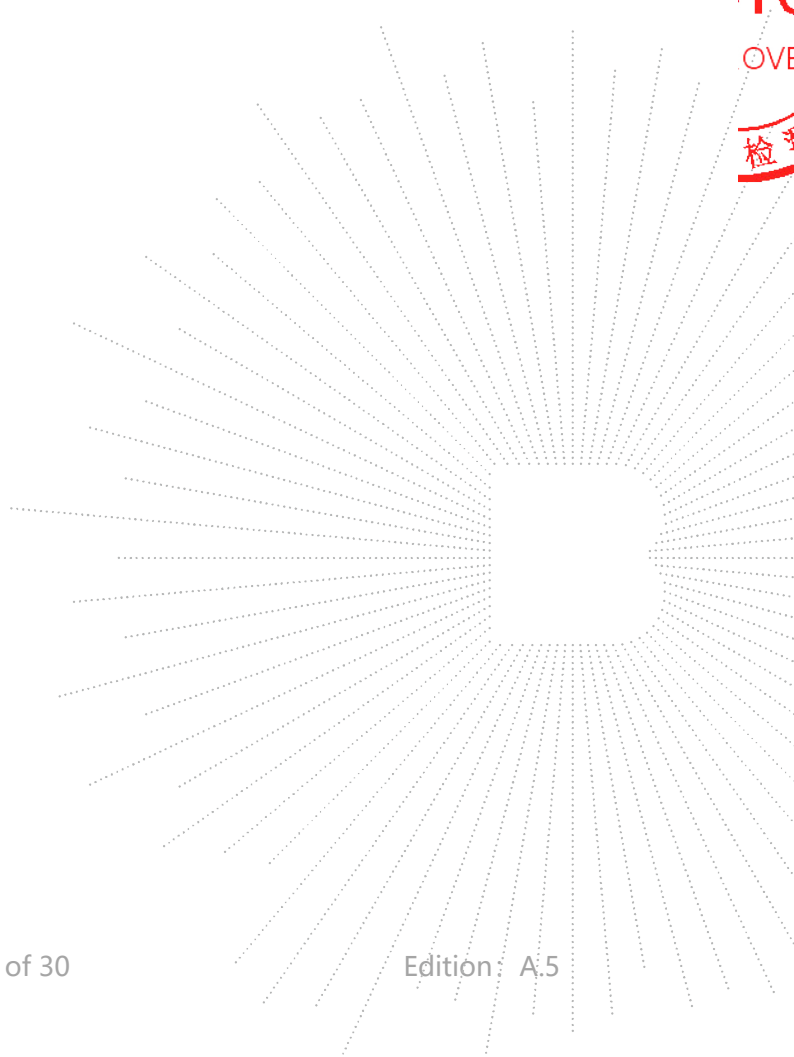

2. Test Summary

The Product has been tested according to the following specifications:

| No. | Test Parameter | Clause No | Results |
|-----|--|-----------|---------|
| 1 | Conducted Emission | 15.207 | N/A |
| 2 | 20dB Bandwidth | 15.215 | PASS |
| 3 | Fundamental & Radiated Spurious Emission Measurement | 15.249 | PASS |
| 4 | Band Edge Emission | 15.205 | PASS |
| 5 | Antenna Requirement | 15.203 | PASS |

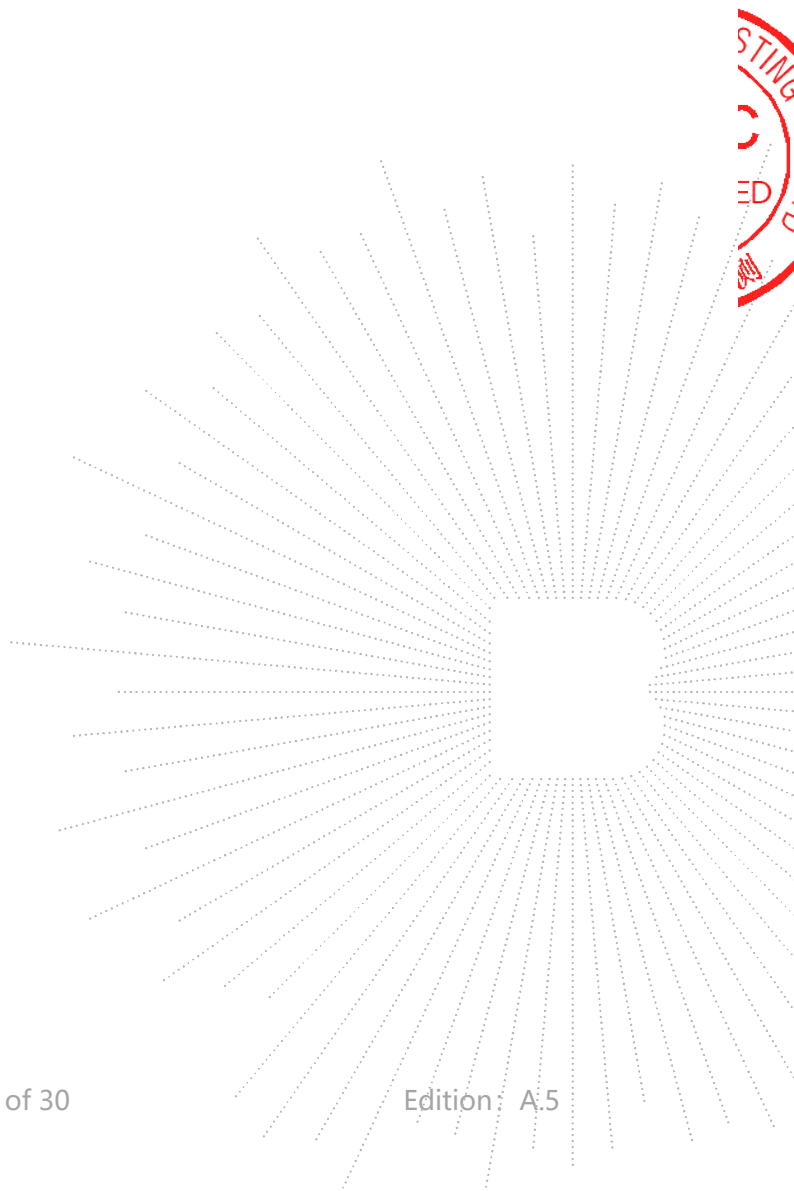

3. Measurement Uncertainty

Where relevant, the following measurement uncertainty levels have been estimated for tests performed on the Product as specified in CISPR 16-4-2. This uncertainty represents an expanded uncertainty expressed at approximately the 95% confidence level using a coverage factor of k=2.

| No. | Item | Uncertainty |
|-----|--|-------------|
| 1 | 3m chamber Radiated spurious emission(9kHz-30MHz) | U=3.7dB |
| 2 | 3m chamber Radiated spurious emission(30MHz-1GHz) | U=4.3dB |
| 3 | 3m chamber Radiated spurious emission(1GHz-18GHz) | U=4.5dB |
| 4 | 3m chamber Radiated spurious emission(18GHz-40GHz) | U=3.34dB |
| 5 | Conducted Emission(150kHz-30MHz) | U=3.20dB |
| 6 | Conducted Adjacent channel power | U=1.38dB |
| 7 | Conducted output power uncertainty Above 1G | U=1.576dB |
| 8 | Conducted output power uncertainty below 1G | U=1.28dB |
| 9 | humidity uncertainty | U=5.3% |
| 10 | Temperature uncertainty | U=0.59°C |

 CO. LTD

4. Product Information And Test Setup

4.1 Product Information

| | |
|-----------------------|---|
| Model/Type Ref.: | YS5002-UC YS5002-UA |
| Model differences: | All the model are the same circuit and RF module, except model names. |
| Hardware Version: | N/A |
| Software Version: | N/A |
| Operation Frequency: | 910.3MHz |
| Type of Modulation: | LoRa |
| Number Of Channel | 1CH |
| Antenna installation: | Spring antenna |
| Antenna Gain: | 0dBi |
| Rated Voltage: | DC 3V From Battery |

4.2 Test Setup Configuration

See test photographs attached in *EUT TEST SETUP PHOTOGRAPHS* for the actual connections between Product and support equipment.

Radiated Spurious Emission:

| |
|------------|
| E-1 EUT |
|------------|

4.3 Support Equipment

| No. | Device Type | Brand | Model | Series No. | Note |
|-----|-----------------|-------|-----------|------------|------|
| E-1 | Motorized valve | N/A | YS5002-UC | -- | EUT |

| Item | Shielded Type | Ferrite Core | Length | Note |
|------|---------------|--------------|--------|------|
| - | - | - | - | - |

Notes:

1. All the equipment/cables were placed in the worst-case configuration to maximize the emission during the test.
2. Grounding was established in accordance with the manufacturer's requirements and conditions for the intended use.



4.4 Channel List

| CH | Frequency (MHz) |
|----|-----------------|
| 1 | 910.3 |

4.5 Test Mode

To investigate the maximum EMI emission characteristics generated from EUT, the test system was pre-scanning tested based on the consideration of following EUT operation mode or test configuration mode which possibly have effect on EMI emission level. Each of these EUT operation mode(s) or test configuration mode(s) mentioned above was evaluated respectively.

| Test Mode | Test mode |
|-----------|--------------|
| 1 | Transmitting |

Note:

(1) Fully-charged battery is used during the test

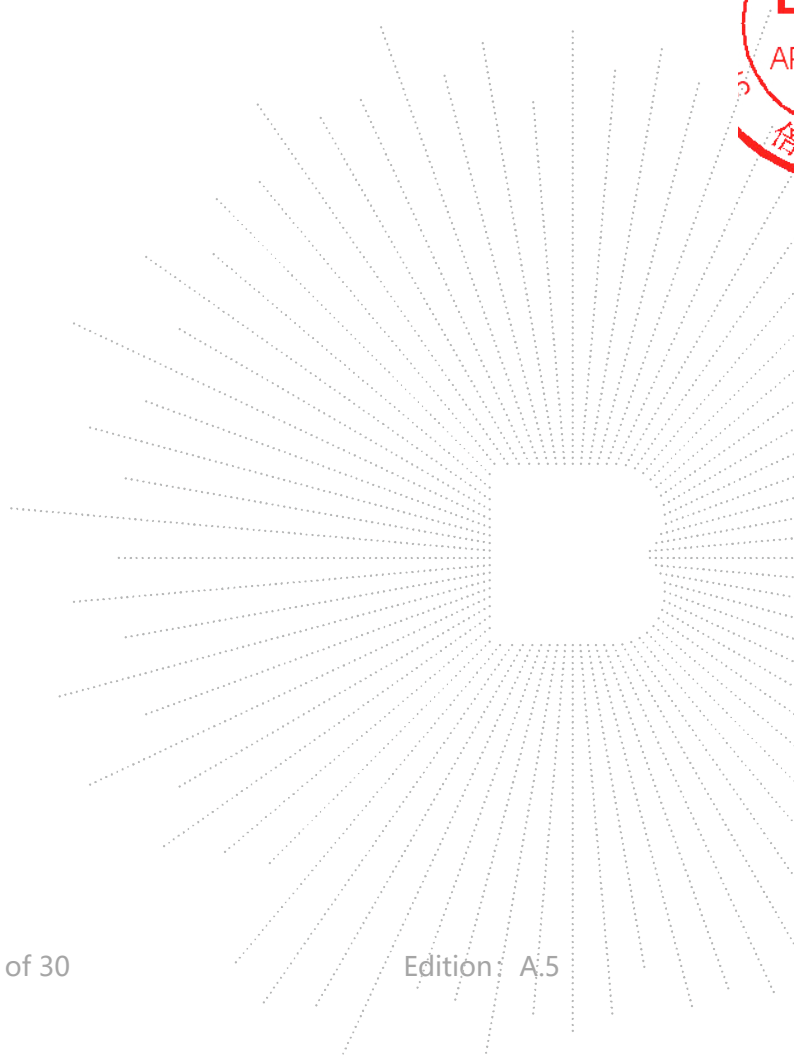

5. Test Facility And Test Instrument Used

5.1 Test Facility

All measurement facilities used to collect the measurement data are located at Shenzhen BCTC Testing Co., Ltd. Address: 1-2/F., Building B, Pengzhou Industrial Park, No.158, Fuyuan 1st Road, Zhancheng, Fuhai Subdistrict, Bao'an District, Shenzhen, Guangdong, China. The site and apparatus are constructed in conformance with the requirements of ANSI C63.4 and CISPR 16-1-1 other equivalent standards.
FCC Test Firm Registration Number: 712850
IC Registered No.: 23583

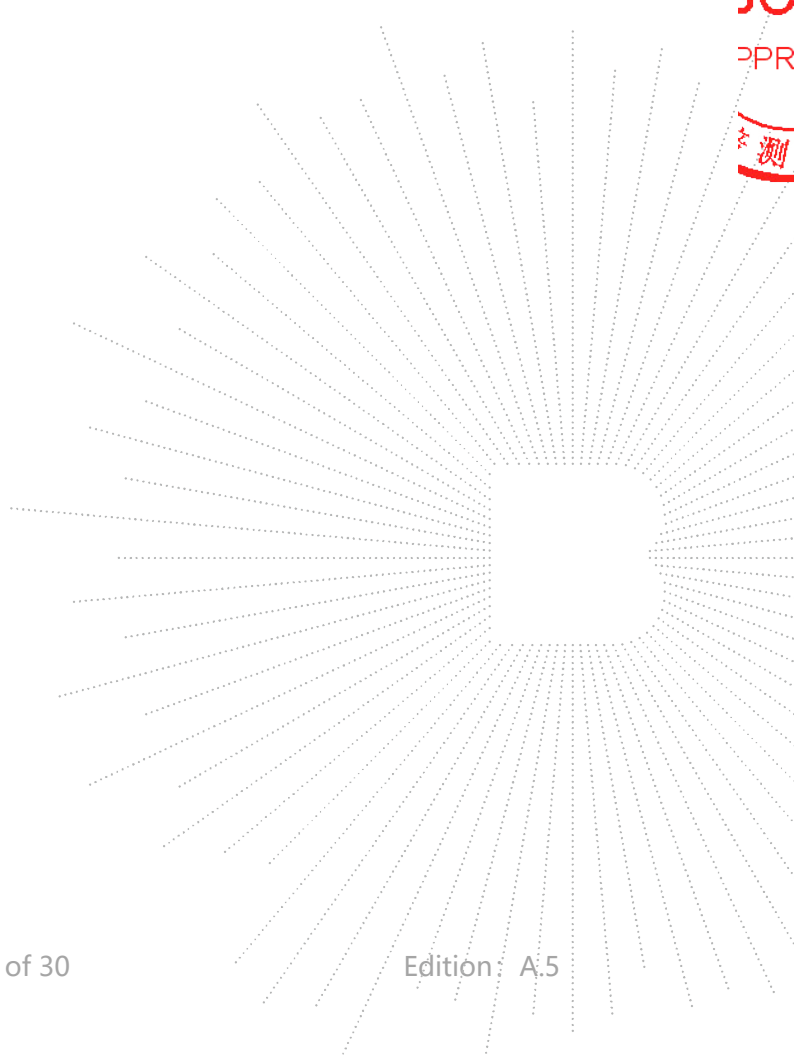

5.2 Test Instrument Used

| Radiated Emissions Test (966 Chamber01) | | | | | |
|---|--------------|-------------------|------------|---------------|---------------|
| Equipment | Manufacturer | Model# | Serial# | Last Cal. | Next Cal. |
| 966 chamber | ChengYu | 966 Room | 966 | Jun. 06. 2020 | Jun. 05, 2023 |
| Receiver | R&S | ESR3 | 102075 | May 24, 2022 | May 23, 2023 |
| Receiver | R&S | ESRP | 101154 | May 24, 2022 | May 23, 2023 |
| Amplifier | Schwarzbeck | BBV9744 | 9744-0037 | May 24, 2022 | May 23, 2023 |
| TRILOG Broadband Antenna | Schwarzbeck | VULB9163 | 942 | May 26, 2022 | May 25, 2023 |
| Loop Antenna(9KHz -30MHz) | Schwarzbeck | FMZB1519B | 00014 | May 26, 2022 | May 25, 2023 |
| Amplifier | SKET | LAPA_01G18 G-45dB | \ | May 24, 2022 | May 23, 2023 |
| Horn Antenna | Schwarzbeck | BBHA9120D | 1541 | Jun. 06, 2022 | Jun. 05, 2023 |
| Amplifier(18G Hz-40GHz) | MITEQ | TTA1840-35-HG | 2034381 | May 26, 2022 | May 25, 2023 |
| Horn Antenna(18G Hz-40GHz) | Schwarzbeck | BBHA9170 | 00822 | Jun. 06, 2022 | Jun. 05, 2023 |
| Spectrum Analyzer9kHz-40GHz | R&S | FSP40 | 100363 | May 24, 2022 | May 23, 2023 |
| Software | Frad | EZ-EMC | FA-03A2 RE | \ | \ |

TEST
 TO
 OVER
 検査

6. Conducted Emissions

6.1 Block Diagram Of Test Setup

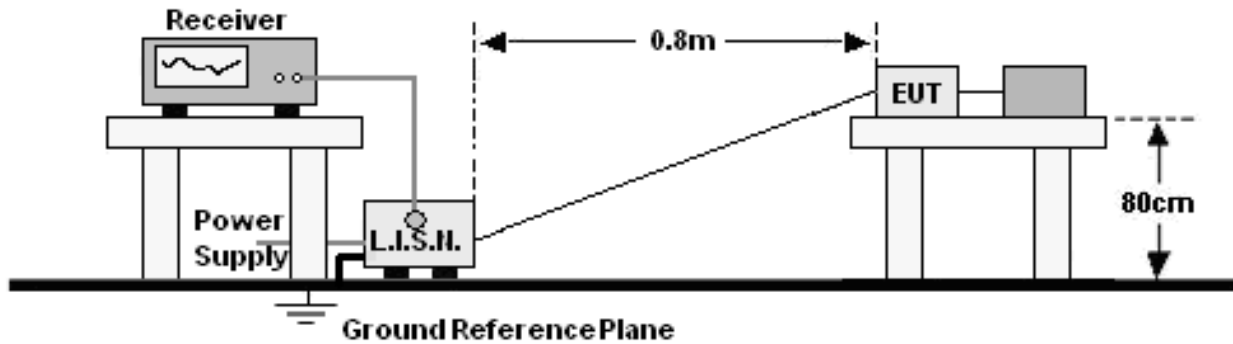

6.2 Limit

| FREQUENCY (MHz) | Limit (dBuV) | |
|-----------------|--------------|-----------|
| | Quas-peak | Average |
| 0.15 -0.5 | 66 - 56 * | 56 - 46 * |
| 0.50 -5.0 | 56.00 | 46.00 |
| 5.0 -30.0 | 60.00 | 50.00 |

Notes:

- *Decreasing linearly with logarithm of frequency.
- The lower limit shall apply at the transition frequencies.

6.3 Test Procedure

| Receiver Parameters | Setting |
|---------------------|----------|
| Attenuation | 10 dB |
| Start Frequency | 0.15 MHz |
| Stop Frequency | 30 MHz |
| IF Bandwidth | 9 kHz |

- The Product was placed on a nonconductive table 0.8 m above the horizontal ground reference plane, and 0.4 m from the vertical ground reference plane, and connected to the main through Line Impedance Stability Network (L.I.S.N).
- The RBW of the receiver was set at 9 kHz in 150 kHz ~ 30MHz with Peak and AVG detector in Max Hold mode. Run the receiver's pre-scan to record the maximum disturbance generated from Product in all power lines in the full band.
- For each frequency whose maximum record was higher or close to limit, measure its QP and AVG values and record.

6.4 EUT Operating Conditions

The EUT was configured for testing in a typical fashion (as a customer would normally use it). The EUT has been programmed to continuously transmit during test. This operating condition was tested and used to collect the included data.

6.5 Test Result

NOTE: This EUT is powered by the battery only, this test item is not applicable.

7. Radiated Emissions

7.1 Block Diagram Of Test Setup

(A) Radiated Emission Test-Up Frequency Below 30MHz

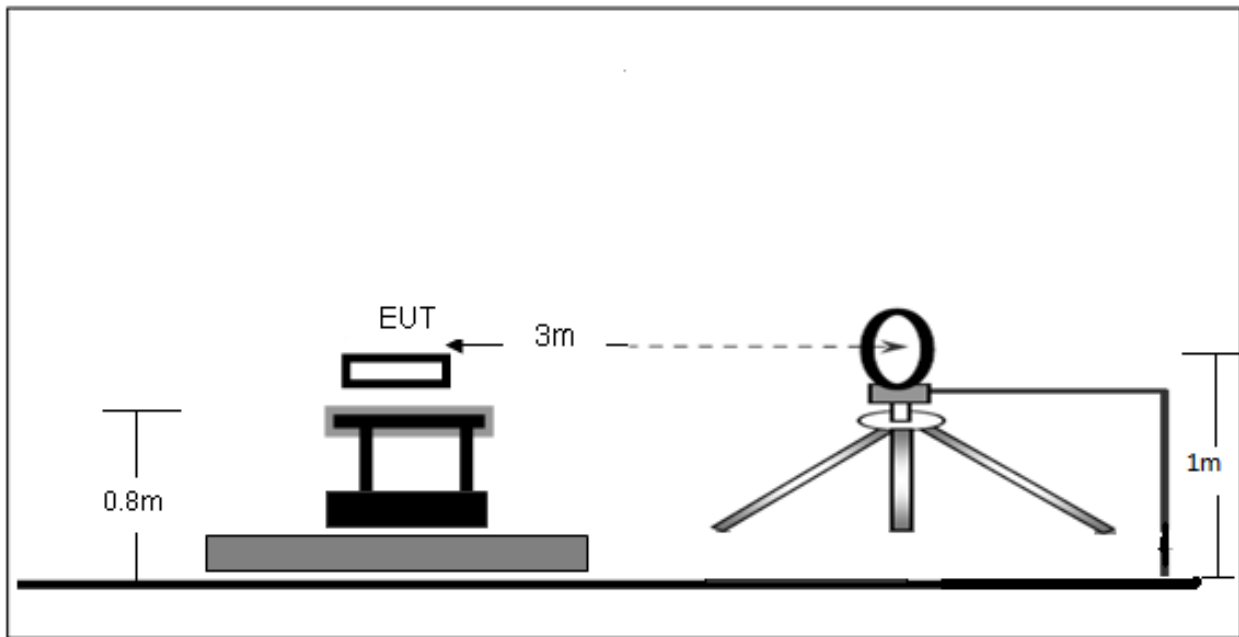

(B) Radiated Emission Test-Up Frequency 30MHz~1GHz

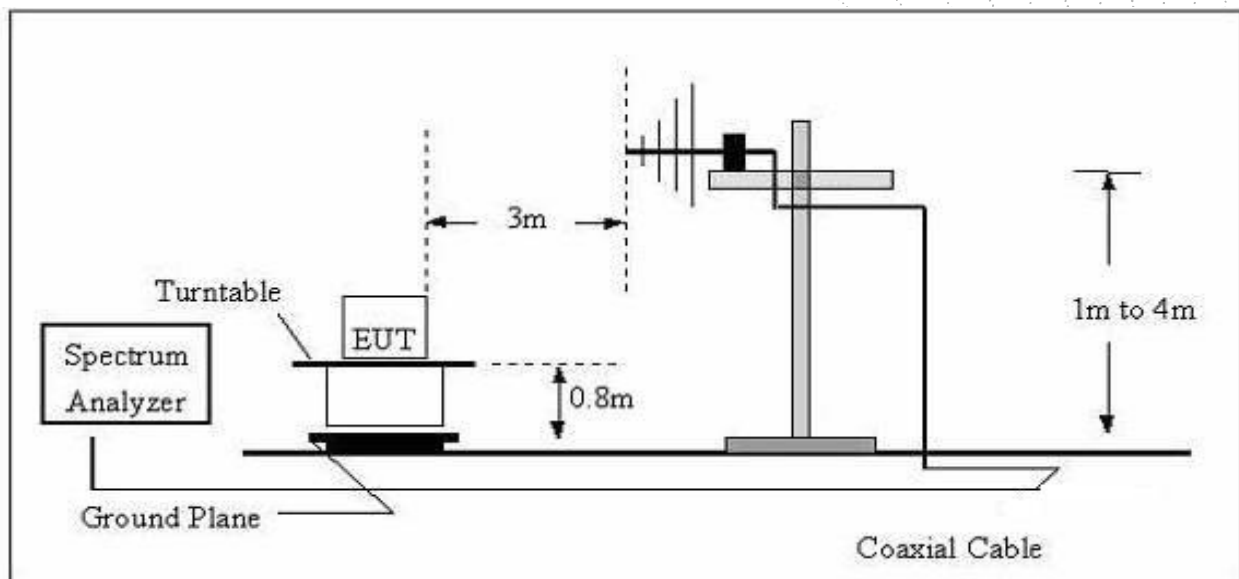

SHENZHEN

(C) Radiated Emission Test-Up Frequency Above 1GHz

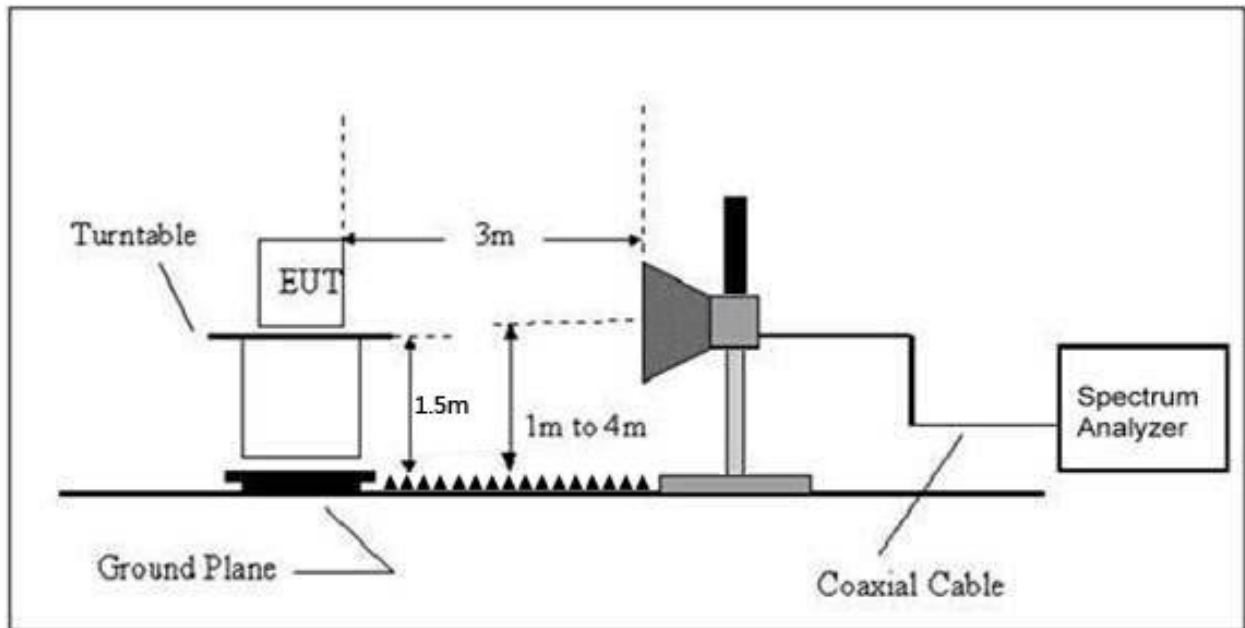

7.2 Limit

In case the emission fall within the restricted band specified on 15.205(a), then the 15.209(a) limit in the table below has to be followed.

| Frequency (MHz) | Field Strength uV/m | Distance (m) | Field Strength Limit at 3m Distance | |
|--------------------|------------------------|-----------------|-------------------------------------|---------------------------------------|
| | | | uV/m | dBuV/m |
| 0.009 ~ 0.490 | $2400/F(\text{kHz})$ | 300 | $10000 * 2400/F(\text{kHz})$ | $20\log^{(2400/F(\text{kHz}))} + 80$ |
| 0.490 ~ 1.705 | $24000/F(\text{kHz})$ | 30 | $100 * 24000/F(\text{kHz})$ | $20\log^{(24000/F(\text{kHz}))} + 40$ |
| 1.705 ~ 30 | 30 | 30 | $100 * 30$ | $20\log^{(30)} + 40$ |
| 30 ~ 88 | 100 | 3 | 100 | $20\log^{(100)}$ |
| 88 ~ 216 | 150 | 3 | 150 | $20\log^{(150)}$ |
| 216 ~ 960 | 200 | 3 | 200 | $20\log^{(200)}$ |
| Above 960 | 500 | 3 | 500 | $20\log^{(500)}$ |

The field strength of emissions from intentional radiators operated within these frequency bands shall comply with the following:

| Fundamental frequency | Field strength of fundamental (millivolts/meter) | Field strength of harmonics (microvolts/meter) |
|-----------------------|--|--|
| 902-928 MHz | 50 | 500 |
| 2400-2483.5 MHz | 50 | 500 |
| 5725-5875 MHz | 50 | 500 |
| 24.0-24.25 GHz | 250 | 2500 |

LIMITS OF RADIATED EMISSION MEASUREMENT (Above 1000MHz)

| FREQUENCY (MHz) | Limit (dBuV/m) (at 3M) | |
|--------------------|------------------------|---------|
| | PEAK | AVERAGE |
| Above 1000 | 74 | 54 |

Notes:

- (1)The limit for radiated test was performed according to FCC PART 15C.
- (2)The tighter limit applies at the band edges.
- (3) Emission level (dBuV/m)=20log Emission level (uV/m).

FREQUENCY RANGE OF RADIATED MEASUREMENT (For unintentional radiators)

| Highest frequency generated or Upper frequency of measurement used in the device or on which the device operates or tunes (MHz) | Range (MHz) |
|---|---|
| Below 1.705 | 30 |
| 1.705 – 108 | 1000 |
| 108 – 500 | 2000 |
| 500 – 1000 | 5000 |
| Above 1000 | 5 th harmonic of the highest frequency or 40 GHz, whichever is lower |

7.3 Test Procedure

| Spectrum Parameter | Setting |
|---------------------------------------|--|
| Attenuation | Auto |
| Start Frequency | 1000 MHz |
| Stop Frequency | 10th carrier harmonic |
| RB / VB (emission in restricted band) | 1 MHz / 1 MHz for Peak, 1 MHz / 10Hz for Average |

| Receiver Parameter | Setting |
|------------------------|----------------------------------|
| Attenuation | Auto |
| Start ~ Stop Frequency | 9kHz~150kHz / RB 200Hz for QP |
| Start ~ Stop Frequency | 150kHz~30MHz / RB 9kHz for QP |
| Start ~ Stop Frequency | 30MHz~1000MHz / RB 120kHz for QP |

BCTC
 3C
 PPR
 检测

Below 1GHz test procedure as below:

- a. The EUT was placed on the top of a rotating table 0.8 meters above the ground at a 3 meter semi-anechoic chamber. The table was rotated 360 degrees to determine the position of the highest radiation.
- b. The EUT was set 3 meters away from the interference-receiving antenna, which was mounted on the top of a variable-height antenna tower.
- c. The antenna height is varied from one meter to four meters above the ground to determine the maximum value of the field strength. Both horizontal and vertical polarizations of the antenna are set to make the measurement.
- d. For each suspected emission, the EUT was arranged to its worst case and then the antenna was tuned to heights from 1 meter to 4 meters (for the test frequency of below 30MHz, the antenna was tuned to heights 1 meter) and the rotatable table was turned from 0 degrees to 360 degrees to find the maximum reading.
- e. The test-receiver system was set to Peak Detect Function and Specified Bandwidth with Maximum Hold Mode.
- f. If the emission level of the EUT in peak mode was 10dB lower than the limit specified, then testing could be stopped and the peak values of the EUT would be reported. Otherwise the emissions that did not have 10dB margin would be re-tested one by one using peak, quasi-peak or average method as specified and then reported in a data sheet.
- g. Different between above is the test site, change from Semi- Anechoic Chamber to fully Anechoic Chamber and change form table 0.8 metre to 1.5 metre(Above 18GHz the distance is 1 meter and table is 1.5 metre).
- h. Test the EUT in the lowest channel ,the middle channel ,the Highest channel.

Note:

Both horizontal and vertical antenna polarities were tested and performed pretest to three orthogonal axis. The worst case emissions were reported.

Above 1GHz test procedure as below:

- a. The EUT was placed on the top of a rotating table 1.5 meters above the ground at a 3 meter chamber. The table was rotated 360 degrees to determine the position of the highest radiation.
- b. The EUT was set 3 meters away from the interference-receiving antenna, which was mounted on the top of a variable-height antenna tower.
- c. The antenna height is varied from one meter to four meters above the ground to determine the maximum value of the field strength. Both horizontal and vertical polarizations of the antenna are set to make the measurement.
- d. For each suspected emission, the EUT was arranged to its worst case and then the antenna was tuned to heights from 1 meter to 4 meters and the rota table was turned from 0 degrees to 360 degrees to find the maximum reading.
- e. The test-receiver system was set to Peak Detect Function and Specified Bandwidth with Maximum Hold Mode.
- f. If the emission level of the EUT in peak mode was 10dB lower than the limit specified, then testing could be stopped and the peak values of the EUT would be reported. Otherwise the emissions that did not have 10dB margin would be re-tested one by one using peak, quasi-peak or average method as specified and then reported in a data sheet.
- g. Test the EUT in the lowest channel, the Highest channel.

Note:

Both horizontal and vertical antenna polarities were tested and performed pretest to three orthogonal axis. The worst case emissions were reported.

7.4 EUT Operating Conditions

The EUT was configured for testing in a typical fashion (as a customer would normally use it). The EUT has been programmed to continuously transmit during test. This operating condition was tested and used to collect the included data.

7.5 Test Result

Below 30MHz

| | | | |
|--------------|---------|--------------------|-------|
| Temperature: | 26°C | Relative Humidity: | 54% |
| Pressure: | 101 kPa | Test Voltage : | DC 3V |
| Test Mode : | Mode 1 | Polarization : | -- |

| Freq. (MHz) | Reading (dBuV/m) | Limit (dBuV/m) | Margin (dB) | State P/F |
|----------------|---------------------|-------------------|----------------|--------------|
| -- | -- | -- | -- | PASS |
| -- | -- | -- | -- | PASS |

Note:

The amplitude of spurious emissions which are attenuated by more than 20dB below the permissible value has no need to be reported.

Distance extrapolation factor = $40 \log(\text{specific distance}/\text{test distance})$ (dB);

Limit line = specific limits(dBuv) + distance extrapolation factor.

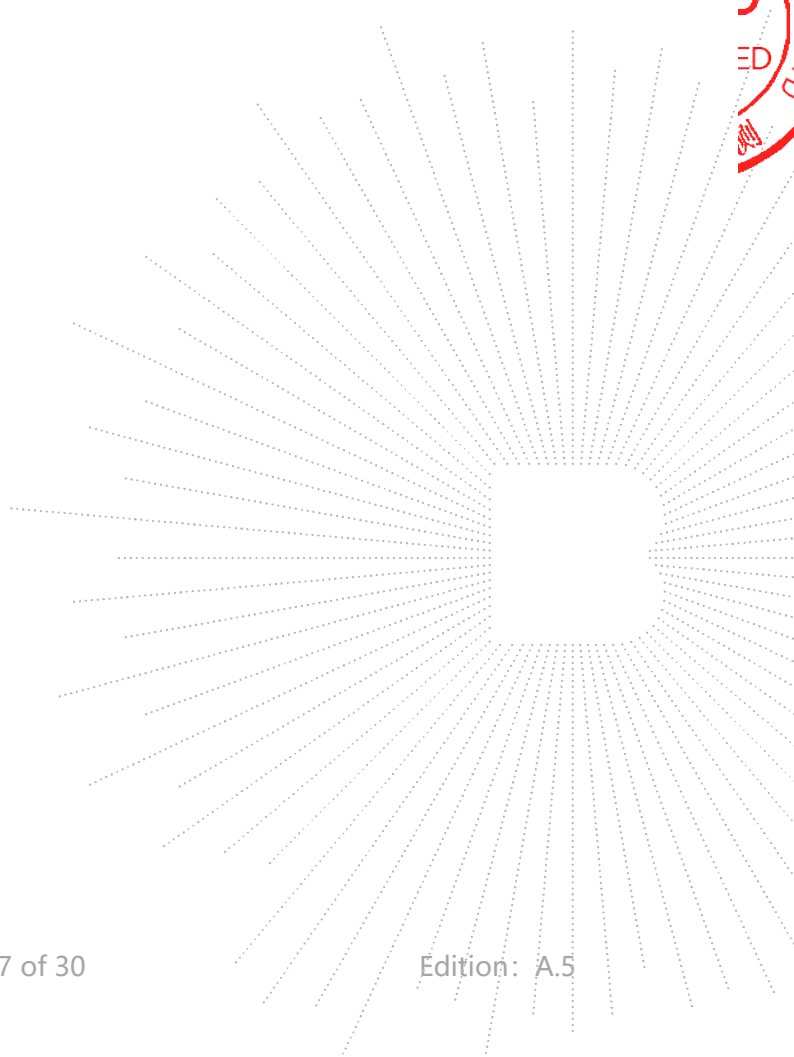

Between 30MHz – 1GHz

| | | | |
|--------------|--------|--------------------|------------|
| Temperature: | 26 °C | Relative Humidity: | 54% |
| Pressure: | 101KPa | Phase : | Horizontal |
| Test Mode: | Mode 1 | Remark: | N/A |

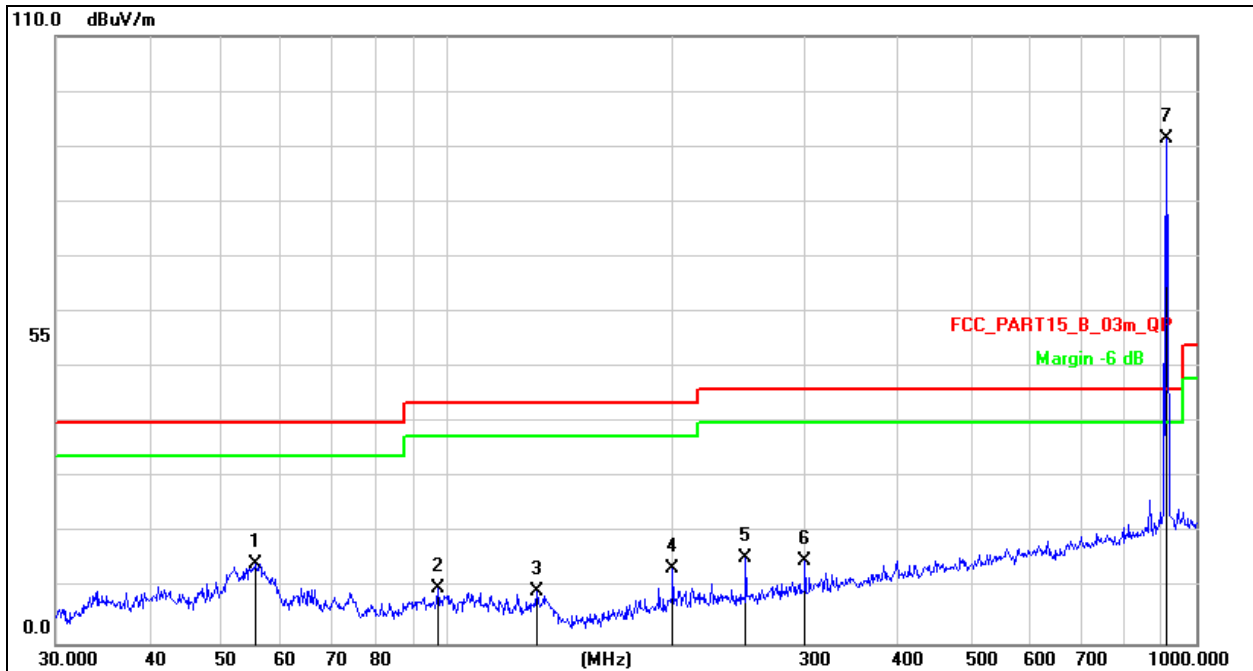

Remark:
 1. Factor = Antenna Factor + Cable Loss – Pre-amplifier.
 2. Measurement=Reading Level+ Correct Factor
 3. Over=Measurement-Limit

| No. | Mk. | Freq. MHz | Reading Level dBuV | Correct Factor dB | Measure- ment dBuV/m | Limit dB/m | Over dB | Detector |
|-----|-----|--------------|--------------------------|-------------------------|----------------------------|---------------|------------|----------|
| 1 | | 55.4147 | 29.87 | -15.42 | 14.45 | 40.00 | -25.55 | QP |
| 2 | | 97.1148 | 26.72 | -16.81 | 9.91 | 43.50 | -33.59 | QP |
| 3 | | 131.7574 | 27.83 | -18.33 | 9.50 | 43.50 | -34.00 | QP |
| 4 | | 199.9856 | 29.96 | -16.30 | 13.66 | 43.50 | -29.84 | QP |
| 5 | | 250.3009 | 30.56 | -15.14 | 15.42 | 46.00 | -30.58 | QP |
| 6 | | 300.3672 | 28.65 | -13.59 | 15.06 | 46.00 | -30.94 | QP |
| 7 | * | 912.8618 | 92.73 | -1.40 | 91.33 | 114.00 | -33.67 | peak |

CO.LTD

| | | | |
|--------------|--------|--------------------|----------|
| Temperature: | 26 °C | Relative Humidity: | 54% |
| Pressure: | 101KPa | Phase : | Vertical |
| Test Mode: | Mode 1 | Remark: | N/A |

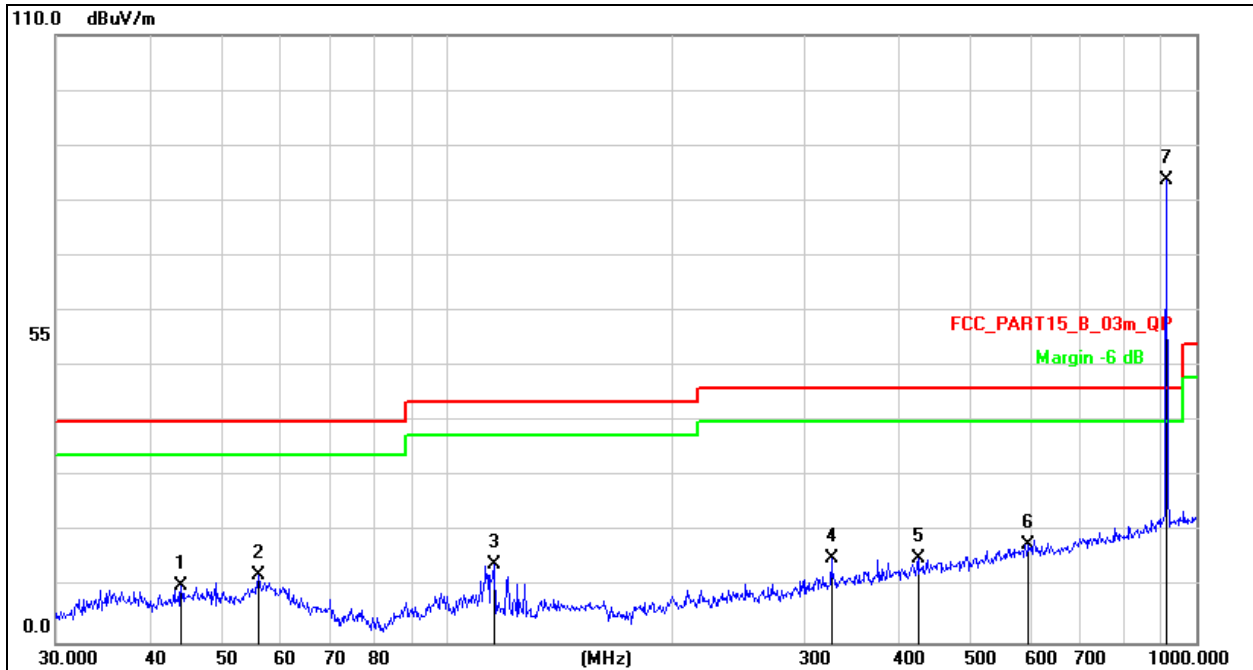

Remark:
 1. Factor = Antenna Factor + Cable Loss – Pre-amplifier.
 2. Measurement=Reading Level+ Correct Factor
 3. Over=Measurement-Limit

| No. | Mk. | Freq. MHz | Reading Level dBuV | Correct Factor dB | Measure- ment dBuV/m | Limit dB/m | Over dB | Detector |
|-----|-----|--------------|--------------------------|-------------------------|----------------------------|---------------|------------|----------|
| 1 | | 44.1200 | 25.41 | -15.18 | 10.23 | 40.00 | -29.77 | QP |
| 2 | | 56.0007 | 27.62 | -15.49 | 12.13 | 40.00 | -27.87 | QP |
| 3 | | 115.3204 | 31.57 | -17.27 | 14.30 | 43.50 | -29.20 | QP |
| 4 | | 325.5957 | 28.24 | -12.90 | 15.34 | 46.00 | -30.66 | QP |
| 5 | | 425.0280 | 25.91 | -10.53 | 15.38 | 46.00 | -30.62 | QP |
| 6 | | 597.2232 | 24.31 | -6.58 | 17.73 | 46.00 | -28.27 | QP |
| 7 | * | 912.8618 | 85.14 | -1.40 | 83.74 | 114.00 | -30.26 | peak |

SHENZHEN

(Above 1000 MHz)
Normal Voltage 910.3MHz

| Polar (H/V) | Frequency (MHz) | Meter Reading (dBuV) | Factor (dB) | Emission Level (dBuV/m) | Limits (dBuV/m) | Margin (dB) | Detector Type |
|----------------|--------------------|----------------------------|----------------|-------------------------------|--------------------|----------------|------------------|
| V | 1820.60 | 54.08 | -3.47 | 50.61 | 74.00 | -23.39 | Pk |
| V | 1820.60 | 45.91 | -3.47 | 42.44 | 54.00 | -11.56 | AV |
| V | 2730.90 | 43.23 | -3.74 | 39.49 | 74.00 | -34.51 | Pk |
| V | 2730.90 | 33.48 | -3.74 | 29.74 | 54.00 | -24.26 | AV |
| V | 3641.20 | 54.16 | -4.59 | 49.57 | 74.00 | -24.43 | Pk |
| V | 3641.20 | 43.29 | -4.59 | 38.70 | 54.00 | -15.30 | AV |
| H | 1820.60 | 51.93 | -3.47 | 48.46 | 74.00 | -25.54 | Pk |
| H | 1820.60 | 41.32 | -3.47 | 37.85 | 54.00 | -16.15 | AV |
| H | 2730.90 | 41.79 | -3.74 | 38.05 | 74.00 | -35.95 | Pk |
| H | 2730.90 | 33.34 | -3.74 | 29.60 | 54.00 | -24.40 | AV |
| H | 3641.20 | 55.52 | -4.59 | 50.93 | 74.00 | -23.07 | Pk |
| H | 3641.20 | 46.72 | -4.59 | 42.13 | 54.00 | -11.87 | AV |

Remark:

Absolute Level= Reading Level+ Factor, Margin= Limit- Absolute Level

Other harmonics emissions are lower than 20dB below the allowable limit.

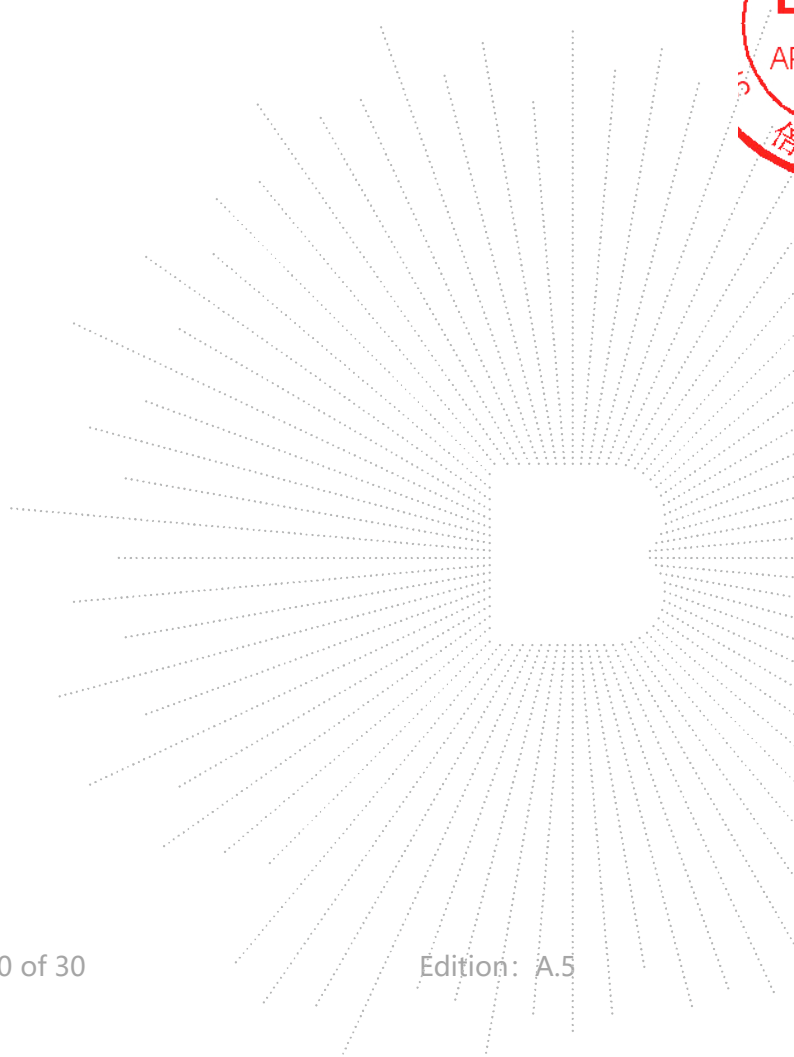

7.6 Field Strength Calculation

The field strength is calculated by adding the Antenna Factor and Cable Factor and subtracting the Amplifier Gain and Duty Cycle Correction Factor (if any) from the measured reading. The basic equation with a sample calculation is as follows:

$$FS=RA+AF+CL-AG$$

| | |
|----------------------|--|
| FS=Field Strength | CL=Cable Attenuation Factor (Cable Loss) |
| RA=Reading Amplitude | AG=Amplifier Gain |
| AF=Antenna Factor | |

Test Result:

| | | | |
|----------------|--------|--------------------|------------|
| Temperature: | 26°C | Relative Humidity: | 54% |
| Pressure: | 101kPa | Polarization : | Horizontal |
| Test Voltage : | DC 3V | | |
| Test Mode : | Mode 1 | | |

| Frequency | Meter Reading | Factor | Emission Level | Limits | Margin | Detector Type |
|-----------|---------------|--------|----------------|----------|--------|---------------|
| (MHz) | (dBμV) | (dB) | (dBμV/m) | (dBμV/m) | (dB) | |
| 910.3 | 92.73 | -1.40 | 91.33 | 114.00 | -22.67 | Peak |
| 910.3 | 92.12 | -1.40 | 90.09 | 94.00 | -3.28 | Average |

Remark:
 Factor = Antenna Factor + Cable Loss – Pre-amplifier.
 All interfaces was connected, and TX mode

| | | | |
|----------------|--------|--------------------|----------|
| Temperature: | 26°C | Relative Humidity: | 54% |
| Pressure: | 101kPa | Polarization : | Vertical |
| Test Voltage : | DC 3V | | |
| Test Mode : | Mode 1 | | |

| Frequency | Meter Reading | Factor | Emission Level | Limits | Margin | Detector Type |
|-----------|---------------|--------|----------------|----------|--------|---------------|
| (MHz) | (dBμV) | (dB) | (dBμV/m) | (dBμV/m) | (dB) | |
| 910.3 | 85.14 | -1.40 | 83.74 | 114.00 | -30.26 | Peak |
| 910.3 | 84.90 | -1.40 | 83.34 | 94.00 | -10.50 | Average |

Remark:
 Factor = Antenna Factor + Cable Loss – Pre-amplifier.
 All interfaces was connected, and TX mode

BCTC
 3C
 PPR
 检测

8. 100 Khz Bandwidth Of Frequency Band Edge

8.1 Block Diagram Of Test Setup

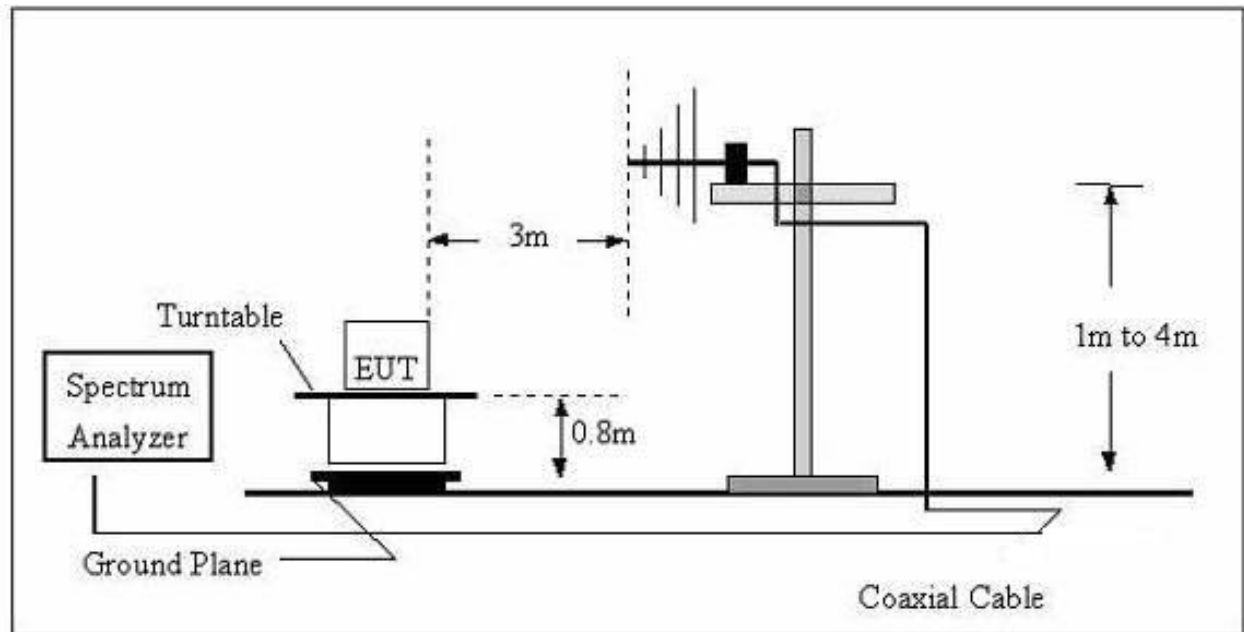

8.2 Applicable Standard

Emissions radiated outside of the specified frequency bands, except for harmonics, shall be attenuated by at least 50 dB below the level of the fundamental or to the general radiated emission limits in § 15.209, whichever is the lesser attenuation

8.3 Test Procedure

- Check the calibration of the measuring instrument using either an internal calibrator or a known signal from an external generator.
- Position the EUT without connection to measurement instrument. Turn on the EUT and connect its antenna terminal to measurement instrument via a low loss cable. Then set it to any one measured frequency within its operating range, and make sure the instrument is operated in its linear range.
- VBW for Peak, Quasi-peak, or Average Detector Function: $3 \times \text{RBW}$
- Repeat above procedures until all measured frequencies were complete.

Note:

Both horizontal and vertical antenna polarities were tested and performed pretest to three orthogonal axis. The worst case emissions were reported.

8.4 EUT Operating Conditions

The EUT tested system was configured as the statements of 2.4 Unless otherwise a special operating condition is specified in the follows during the testing.

8.5 Test Result

| | | | |
|--------------|--------------|--------------------|-------|
| Temperature: | 26 °C | Relative Humidity: | 54% |
| Pressure: | 101 kPa | Test Voltage : | DC 3V |
| Test Mode : | Transmitting | | |

910.3MHz Horizontal

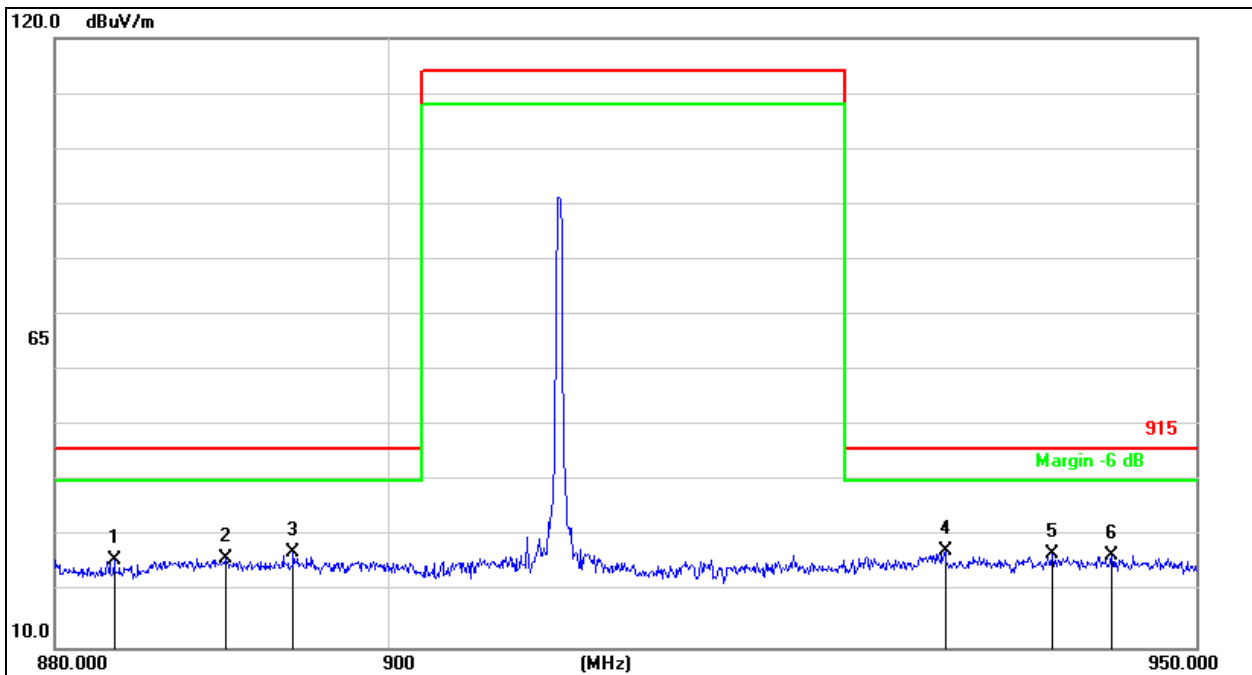

| No. Mk. | Freq. MHz | Reading Level dBuV | Correct Factor dB | Measure- ment dBuV/m | Limit dB/m | Over dB | Detector |
|---------|--------------|--------------------------|-------------------------|----------------------------|---------------|------------|----------|
| 1 | 883.5700 | 25.70 | 0.05 | 25.75 | 46.00 | -20.25 | QP |
| 2 | 890.2200 | 25.98 | 0.22 | 26.20 | 46.00 | -19.80 | QP |
| 3 | 894.2100 | 26.83 | 0.32 | 27.15 | 46.00 | -18.85 | QP |
| 4 * | 934.1798 | 26.95 | 0.44 | 27.39 | 46.00 | -18.61 | QP |
| 5 | 940.8999 | 26.42 | 0.44 | 26.86 | 46.00 | -19.14 | QP |
| 6 | 944.6798 | 26.32 | 0.43 | 26.75 | 46.00 | -19.25 | QP |

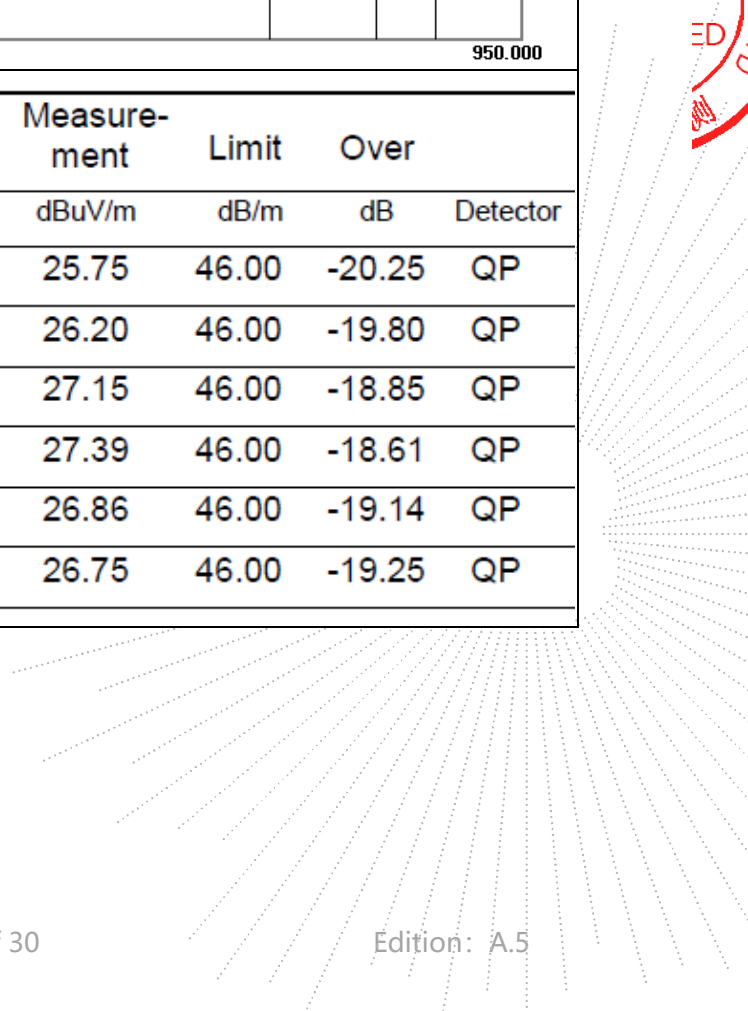

910.3MHz Vertical

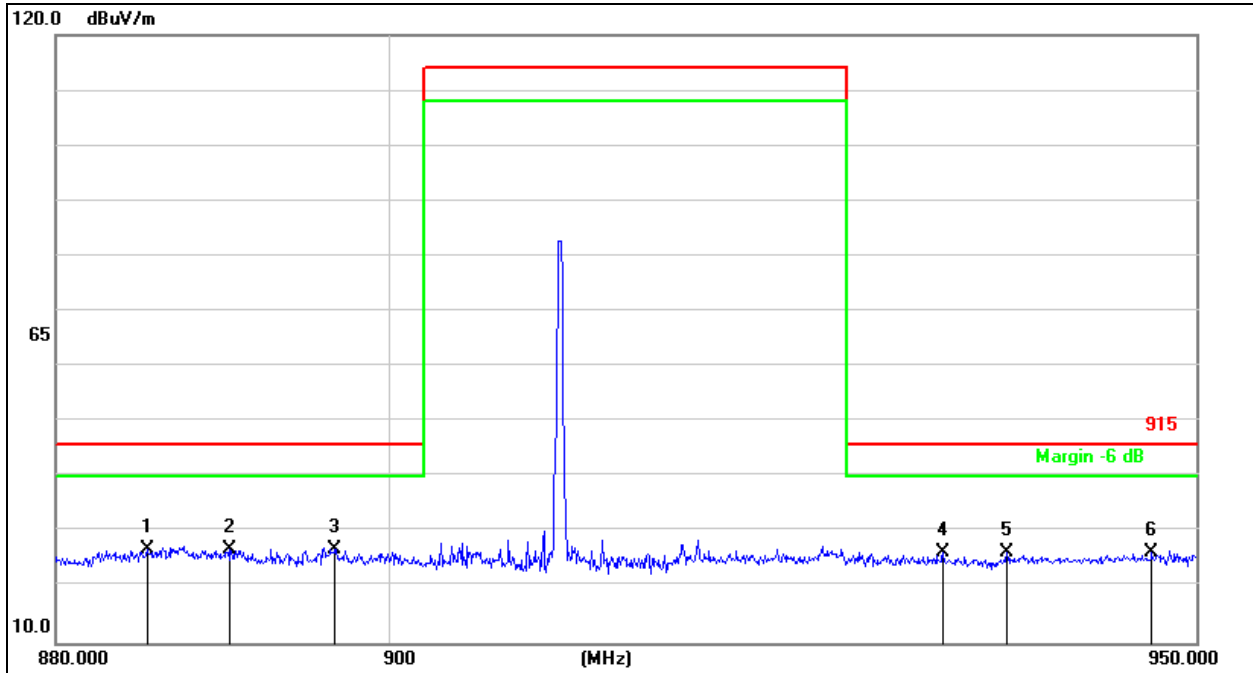

| No. | Mk. | Freq. MHz | Reading Level dBuV | Correct Factor dB | Measure- ment dBuV/m | Limit dB/m | Over dB | Detector |
|-----|-----|--------------|--------------------------|-------------------------|----------------------------|---------------|------------|----------|
| 1 | | 885.4600 | 26.70 | 0.10 | 26.80 | 46.00 | -19.20 | QP |
| 2 | | 890.4298 | 26.76 | 0.22 | 26.98 | 46.00 | -19.02 | QP |
| 3 | * | 896.6598 | 26.66 | 0.38 | 27.04 | 46.00 | -18.96 | QP |
| 4 | | 934.0398 | 25.79 | 0.44 | 26.23 | 46.00 | -19.77 | QP |
| 5 | | 938.0298 | 25.83 | 0.44 | 26.27 | 46.00 | -19.73 | QP |
| 6 | | 947.2000 | 25.85 | 0.43 | 26.28 | 46.00 | -19.72 | QP |

CO.LTD

9. 20 Db Bandwidth

9.1 Block Diagram Of Test Setup

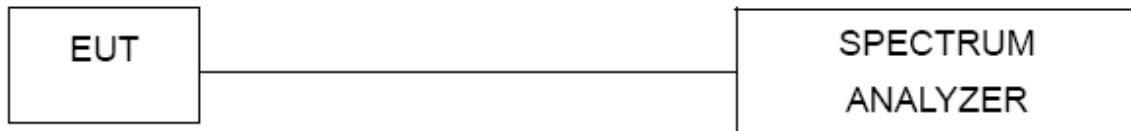

9.2 Limit

| FCC Part15 (15.249) , Subpart C | | | |
|---------------------------------|-----------|-----------------------|--------|
| Section | Test Item | Frequency Range (MHz) | Result |
| 15.249 | Bandwidth | 902~928 | PASS |

9.3 Test Procedure

1. Set resolution bandwidth (RBW) = 1-5% or DTS BW, not to exceed 100 kHz.
2. Set the video bandwidth (VBW) $\geq 3 \times$ RBW.
3. Detector = Peak.
4. Trace mode = max hold.
5. Sweep = auto couple.
6. Allow the trace to stabilize.
7. Measure the maximum width of the emission that is constrained by the frequencies associated with the two outermost amplitude points (upper and lower) that are attenuated by 20 dB relative to the maximum level measured in the fundamental emission.

9.4 EUT Operation Conditions

The EUT tested system was configured as the statements of 2.4 Unless otherwise a special operating condition is specified in the follows during the testing.

9.5 Test Result

| | | | |
|----------------|-------|---------------------|-----|
| Temperature : | 26°C | Relative Humidity : | 54% |
| Test Voltage : | DC 3V | Remark | N/A |

| Channel | Frequency (MHz) | 20dB bandwidth (KHz) |
|---------|-----------------|----------------------|
| 01 | 910.3 | 137 |

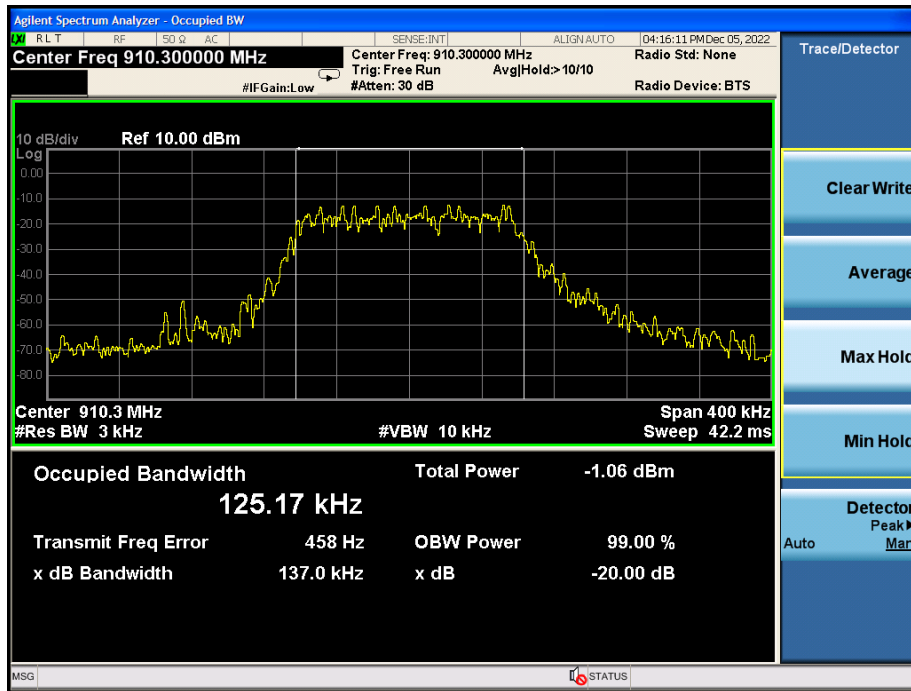
CH01

10. Antenna Requirement

10.1 Limit

15.203 requirement: For intentional device, according to 15.203: an intentional radiator shall be designed to ensure that no antenna other than that furnished by the responsible party shall be used with the device.

10.2 Test Result

The EUT antenna is Spring antenna, The antenna gain is 0dBi, fulfill the requirement of this section.

TC
3C
PPR
測

11. EUT Photographs

EUT Photo 1

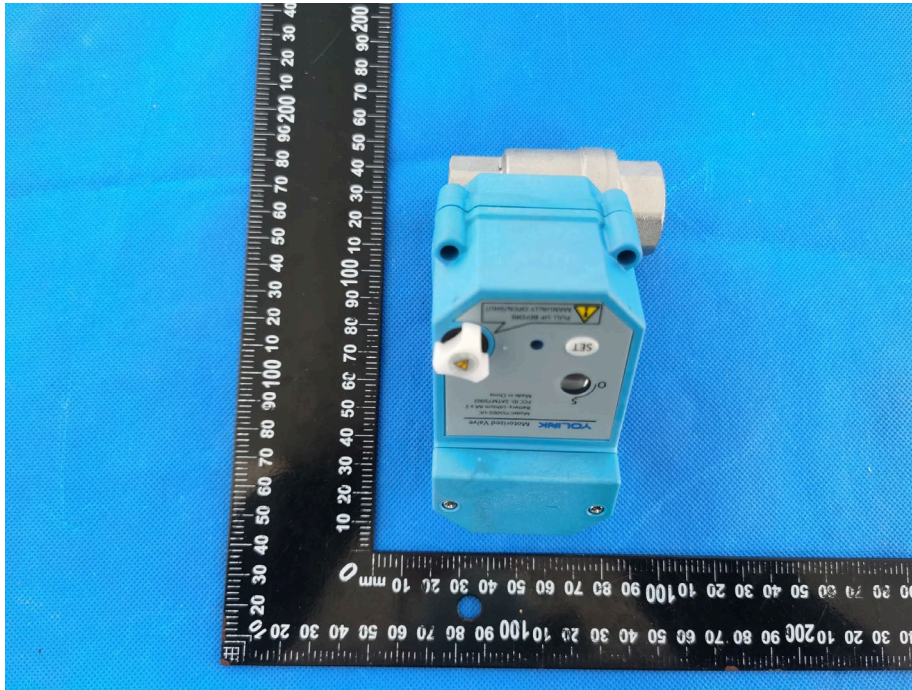

EUT Photo 2

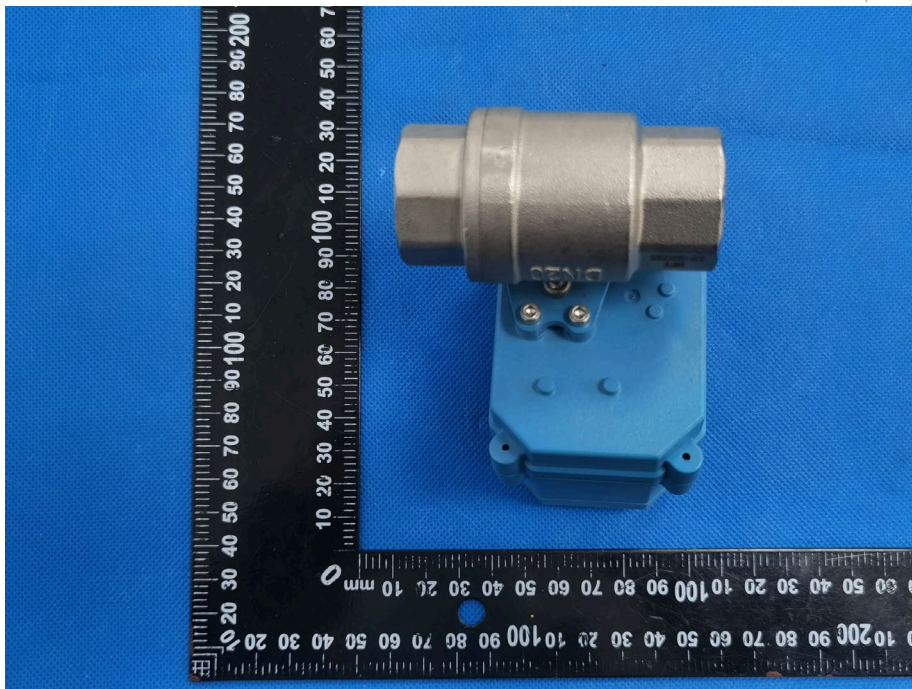

TEC
TC
OVER
檢

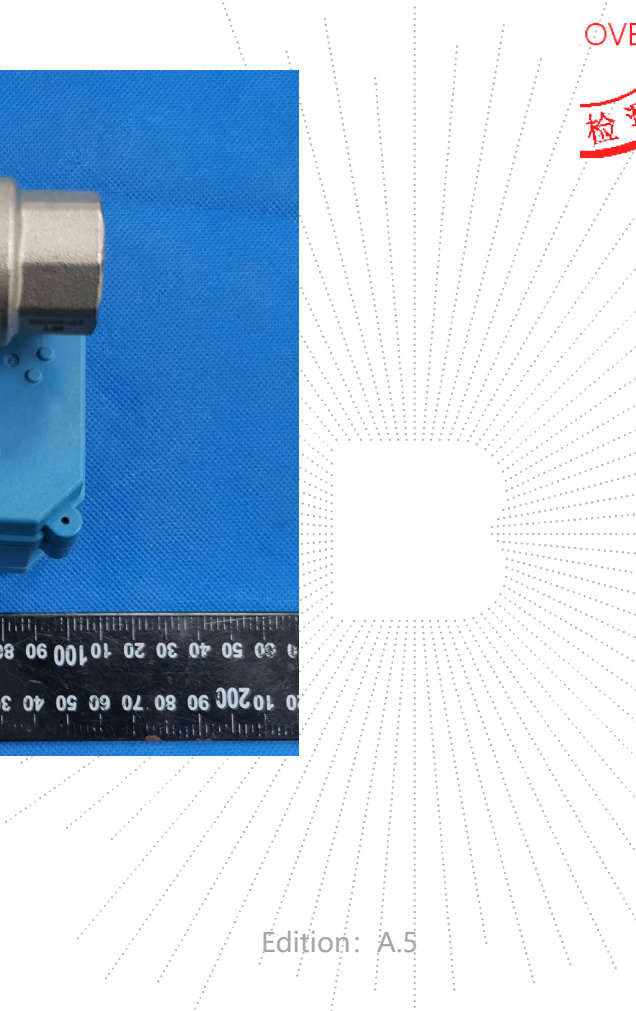

12. EUT Test Setup Photographs

Radiated Measurement Photos



STATEMENT

1. The equipment lists are traceable to the national reference standards.
2. The test report can not be partially copied unless prior written approval is issued from our lab.
3. The test report is invalid without the "special seal for inspection and testing".
4. The test report is invalid without the signature of the approver.
5. The test process and test result is only related to the Unit Under Test.
6. Sample information is provided by the client and the laboratory is not responsible for its authenticity.
7. The test report without CMA mark is only used for scientific research, teaching, enterprise product development and internal quality control purposes.
8. The quality system of our laboratory is in accordance with ISO/IEC17025.
9. If there is any objection to this test report, the client should inform issuing laboratory within 15 days from the date of receiving test report.

Address:

1-2/F., Building B, Pengzhou Industrial Park, No.158, Fuyuan 1st Road, Zhancheng, Fuhai Subdistrict, Bao'an District, Shenzhen, Guangdong, China

TEL: 400-788-9558

P.C.: 518103

FAX: 0755-33229357

Website: <http://www.chnbctc.com>

E-Mail: bctc@bctc-lab.com.cn

***** END *****