

# FCC Part 15C Test Report

## FCC ID: 2ATM74002

Product Name:	YoLink Thermostat
Trademark:	N/A
Model Name :	YS4002-UC YS4002-UA
Prepared For :	YoSmart Inc.
Address :	17165 Von Karman Avenue, Suite 105, Irvine CA, 92614, USA
Prepared By :	Shenzhen BCTC Testing Co., Ltd.
Address :	BCTC Building & 1-2F, East of B Building, Pengzhou Industrial, Fuyuan 1st Road, Qiaotou Community, Fuyong Street, Bao'an District, Shenzhen, China
Test Date:	Apr. 15, 2020 – Apr. 27, 2020
Date of Report :	Apr. 27, 2020
Report No.:	BCTC2004001119E

## TEST RESULT CERTIFICATION

**Applicant's name** ..... : YoSmart Inc.

Address ..... : 17165 Von Karman Avenue, Suite 105, Irvine CA, 92614, USA

**Manufacturer's Name** ..... : YoSmart Inc.

Address ..... : 17165 Von Karman Avenue, Suite 105, Irvine CA, 92614, USA

**Product description**

Product name..... : YoLink Thermostat

Model and/or type reference : YS4002-UC

Serial Model ..... : YS4002-UA

Test Standards..... : FCC Part15.249  
ANSI C63.10-2013

This device described above has been tested by BCTC, and the test results show that the equipment under test (EUT) is in compliance with the FCC requirements. And it is applicable only to the tested sample identified in the report.

This report shall not be reproduced except in full, without the written approval of BCTC, this document may be altered or revised by BCTC, personal only, and shall be noted in the revision of the document.

Prepared by(Engineer):

Cai Fangzhong

*Cai Fang Zhong*

Reviewer(Supervisor):

Eric Yang

*Eric Yang*

Approved(Manager):

Zero Zhou



**Table of Contents**

	<b>Page</b>
<b>1 . SUMMARY OF TEST RESULTS</b>	<b>5</b>
1.1 TEST FACILITY	6
1.2 MEASUREMENT UNCERTAINTY	6
<b>2 . GENERAL INFORMATION</b>	<b>7</b>
2.1 GENERAL DESCRIPTION OF EUT	7
2.2 DESCRIPTION OF TEST MODES	8
2.3 BLOCK DIGRAM SHOWING THE CONFIGURATION OF SYSTEM TESTED	9
2.4 DESCRIPTION OF SUPPORT UNITS(CONDUCTED MODE)	9
2.5 EQUIPMENTS LIST FOR ALL TEST ITEMS	10
<b>3 . EMC EMISSION TEST</b>	<b>12</b>
3.1 CONDUCTED EMISSION MEASUREMENT	12
3.1.1 POWER LINE CONDUCTED EMISSION LIMITS	12
3.1.2 TEST PROCEDURE	12
3.1.3 DEVIATION FROM TEST STANDARD	12
3.1.4 TEST SETUP	13
3.1.5 EUT OPERATING CONDITIONS	13
3.1.6 TEST RESULTS	14
3.2 RADIATED EMISSION MEASUREMENT	16
3.2.1 RADIATED EMISSION LIMITS	16
3.2.2 TEST PROCEDURE	17
3.2.3 DEVIATION FROM TEST STANDARD	17
3.2.4 TEST SETUP	18
3.2.5 EUT OPERATING CONDITIONS	19
3.2.6 TEST RESULTS (BETWEEN 9KHZ – 30 MHZ)	20
3.2.7 TEST RESULTS (BETWEEN 30MHZ – 1GHZ)	21
3.2.8 TEST RESULTS (ABOVE 1000 MHZ)	23
<b>4 . 100 KHZ BANDWIDTH OF FREQUENCY BAND EDGE</b>	<b>25</b>
4.1 DEVIATION FROM STANDARD	25
4.2 TEST SETUP	25
4.3 EUT OPERATION CONDITIONS	25
4.4 TEST RESULTS	25
<b>5 . BANDWIDTH TEST</b>	<b>28</b>
5.1 APPLIED PROCEDURES / LIMIT	28
5.1.1 TEST PROCEDURE	28
5.1.2 DEVIATION FROM STANDARD	28



**Table of Contents**

	<b>Page</b>
5.1.3 TEST SETUP	28
5.1.4 EUT OPERATION CONDITIONS	28
5.1.5 TEST RESULTS	29
<b>6 . ANTENNA REQUIREMENT</b>	<b>30</b>
6.1 STANDARD REQUIREMENT	30
6.2 EUT ANTENNA	30
<b>7 . EUT TEST PHOTO</b>	<b>31</b>
<b>8 . PHOTO OF THE EUT</b>	<b>33</b>



## 1. SUMMARY OF TEST RESULTS

Test procedures according to the technical standards:

FCC Part15 (15.249) , Subpart C			
Standard Section	Test Item	Judgment	Remark
15.207	Conducted Emission	PASS	
15.249	20dB Bandwidth	PASS	
15.249	Fundamental & Radiated Spurious Emission Measurement	PASS	
15.205	Band Edge Emission	PASS	
15.203	Antenna Requirement	PASS	

NOTE:

(1) "N/A" denotes test is not applicable in this Test Report

### 1.1 TEST FACILITY

Shenzhen BCTC Testing Co., Ltd.

Add. : BCTC Building & 1-2F, East of B Building, Pengzhou Industrial, Fuyuan 1st Road, Qiaotou Community, Fuyong Street, Bao'an District, Shenzhen, China

FCC Test Firm Registration Number: 712850

IC Registered No.: 23583

### 1.2 MEASUREMENT UNCERTAINTY

The reported uncertainty of measurement  $y \pm U$ , where expanded uncertainty  $U$  is based on a standard uncertainty multiplied by a coverage factor of  $k=2$ , providing a level of confidence of approximately **95 %**.

No.	Item	Uncertainty
1	3m chamber Radiated spurious emission(30MHz-1GHz)	U=4.3dB
2	3m chamber Radiated spurious emission(1GHz-18GHz)	U=4.5dB
3	3m chamber Radiated spurious emission(18GHz-40GHz)	U=3.34dB
4	Conducted Adjacent channel power	U=1.38dB
5	Conducted output power uncertainty Above 1G	U=1.576dB
6	Conducted output power uncertainty below 1G	U=1.28dB
7	humidity uncertainty	U=5.3%
8	Temperature uncertainty	U=0.59 °C



## 2. GENERAL INFORMATION

### 2.1 GENERAL DESCRIPTION OF EUT

Equipment	YoLink Thermostat	
Trade Name	N/A	
Model Name	YS4002-UC	
Serial Model	YS4002-UA	
Model Difference	All the model are the same circuit and RF module, except model names .	
Product Description	The EUT is a YoLink Thermostat	
	Operation Frequency:	910.3MHz
	Modulation Type:	LoRa
	Number Of Channel	1CH
	Antenna Designation:	Please see Note 3.
Antenna Gain (dBi)	1dBi	
Channel List	Please refer to the Note 2.	
Power	AC24V	
Connecting I/O Port(s)	Please refer to the User's Manual	

Note:

1. For a more detailed features description, please refer to the manufacturer's specifications or the User's Manual.

2.

Channel List for 910.3MHz	
Channel	Frequency (MHz)
01	910.3

3.

Table for Spring Antenna

An.	Brand	Model Name	Antenna Type	Connector	Gain (dBi)	NOTE
A	N/A	N/A	Spring antenna	N/A	1	



## 2.2 DESCRIPTION OF TEST MODES

To investigate the maximum EMI emission characteristics generated from EUT, the test system was pre-scanning tested based on the consideration of following EUT operation mode or test configuration mode which possibly have effect on EMI emission level. Each of these EUT operation mode(s) or test configuration mode(s) mentioned above was evaluated respectively.

For Radiated Emission	
Final Test Mode	Description
Mode 1	TX Mode

Note:

- (1) The measurements are performed at the highest, middle, lowest available channels.
- (2) The measurements are performed at all Bit Rate of Transmitter, the worst data was reported



### 2.3 BLOCK DIGRAM SHOWING THE CONFIGURATION OF SYSTEM TESTED

Conducted Emission Test

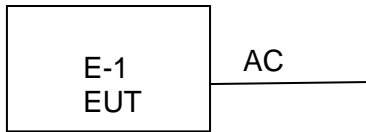

Radiated Spurious Emission Test

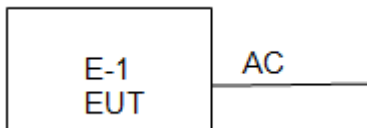

### 2.4 DESCRIPTION OF SUPPORT UNITS(CONDUCTED MODE)

The EUT has been tested as an independent unit together with other necessary accessories or support units. The following support units or accessories were used to form a representative test configuration during the tests.

Item	Equipment	Mfr/Brand	Model/Type No.	Series No.	Note
E-1	YoLink Thermostat	N/A	YS4002-UC	N/A	EUT

Item	Shielded Type	Ferrite Core	Length	Note
	NO	NO	1.2M	AC cable unshielded

Note:

- (1) The support equipment was authorized by Declaration of Confirmation.
- (2) For detachable type I/O cable should be specified the length in cm in 『Length』 column.

## 2.5 EQUIPMENTS LIST FOR ALL TEST ITEMS

### Radiation Test equipment

Item	Equipment	Manufacturer	Type No.	Serial No.	Last calibration	Calibrated until
1	Spectrum Analyzer (9kHz-26.5GHz)	Agilent	E4407B	MY45109572	Jun. 13, 2019	Jun. 12, 2020
2	Test Receiver (9kHz-7GHz)	R&S	ESR7	101154	Jun. 13, 2019	Jun. 12, 2020
3	Bilog Antenna (30MHz-3GHz)	SCHWARZBECK	VULB9163	VULB9163-942	Jun. 22, 2019	Jun. 21, 2020
4	Horn Antenna (1GHz-18GHz)	SCHWARZBECK	BBHA9120D	1541	Jun. 22, 2019	Jun. 21, 2020
5	Horn Antenna (18GHz-40GHz)	SCHWARZBECK	BBHA9170	822	Jun. 22, 2019	Jun. 21, 2020
6	Amplifier (9KHz-6GHz)	SCHWARZBECK	BBV9744	9744-0037	Jun. 25, 2019	Jun. 24, 2020
7	Amplifier (0.5GHz-18GHz)	SCHWARZBECK	BBV9718	9718-309	Jun. 25, 2019	Jun. 24, 2020
8	Amplifier (18GHz-40GHz)	MITEQ	TTA1840-35-HG	2034381	Jun. 17, 2019	Jun. 16, 2020
9	Loop Antenna (9KHz-30MHz)	SCHWARZBECK	FMZB1519B	014	Jul. 02, 2019	Jul. 01, 2020
10	RF cables1 (9kHz-30MHz)	Huber+Suhnar	9kHz-30MHz	B1702988-0008	Jun. 25, 2019	Jun. 24, 2020
11	RF cables2 (30MHz-1GHz)	Huber+Suhnar	30MHz-1GHz	1486150	Jun. 25, 2019	Jun. 24, 2020
12	RF cables3 (1GHz-40GHz)	Huber+Suhnar	1GHz-40GHz	1607106	Jun. 25, 2019	Jun. 24, 2020
13	Power Metter	Keysight	E4419B	\	Jun. 17, 2019	Jun. 16, 2020
14	Power Sensor (AV)	Keysight	E9 300A	\	Jun. 17, 2019	Jun. 16, 2020
15	Signal Analyzer 20kHz-26.5GHz	KEYSIGHT	N9020A	MY4910.30060	Jun. 13, 2019	Jun. 12, 2020
16	Spectrum Analyzer 9kHz-40GHz	Aglient	FSP40	100363	Jun. 13, 2019	Jun. 12, 2020
17	D.C. Power Supply	LongWei	TPR-6405D	\	\	\
18	Software	Frad	EZ-EMC	FA-03A2 RE	\	\



Conduction Test equipment

Item	Equipment	Manufacturer	Type No.	Serial No.	Last calibration	Calibrated until
1	Test Receiver	R&S	ESR3	102075	Jun. 13, 2019	Jun. 12, 2020
2	LISN	SCHWARZBEC K	NSLK8127	8127739	Jun. 13, 2019	Jun. 12, 2020
3	LISN	R&S	ENV216	101375	Jun. 13, 2019	Jun. 12, 2020
4	RF cables	Huber+Suhnar	9kHz-30MHz	B1702988-00 08	Jun. 25, 2019	Jun. 24, 2020
5	Software	Frad	EZ-EMC	EMC-CON 3A1	\	\

### 3. EMC EMISSION TEST

#### 3.1 CONDUCTED EMISSION MEASUREMENT

##### 3.1.1 POWER LINE CONDUCTED EMISSION Limits (Frequency Range 150KHz-30MHz)

FREQUENCY (MHz)	Limit (dBuV)		Standard
	Quasi-peak	Average	
0.15 -0.5	66 - 56 *	56 - 46 *	FCC
0.50 -5.0	56.00	46.00	FCC
5.0 -30.0	60.00	50.00	FCC

Note:

- (1) The tighter limit applies at the band edges.
- (2) The limit of " \* " marked band means the limitation decreases linearly with the logarithm of the frequency in the range.

The following table is the setting of the receiver

Receiver Parameters	Setting
Attenuation	10 dB
Start Frequency	0.15 MHz
Stop Frequency	30 MHz
IF Bandwidth	9 kHz

##### 3.1.2 TEST PROCEDURE

- a. The EUT was placed 0.8 meters from the horizontal ground plane with EUT being connected to the power mains through a line impedance stabilization network (LISN). All other support equipments powered from additional LISN(s). The LISN provide 50 Ohm/ 50uH of coupling impedance for the measuring instrument.
- b. Interconnecting cables that hang closer than 40 cm to the ground plane shall be folded back and forth in the center forming a bundle 30 to 40 cm long.
- c. I/O cables that are not connected to a peripheral shall be bundled in the center. The end of the cable may be terminated, if required, using the correct terminating impedance. The overall length shall not exceed 1 m.
- d. LISN at least 80 cm from nearest part of EUT chassis.
- e. For the actual test configuration, please refer to the related Item –EUT Test Photos.

##### 3.1.3 DEVIATION FROM TEST STANDARD

No deviation

### 3.1.4 TEST SETUP

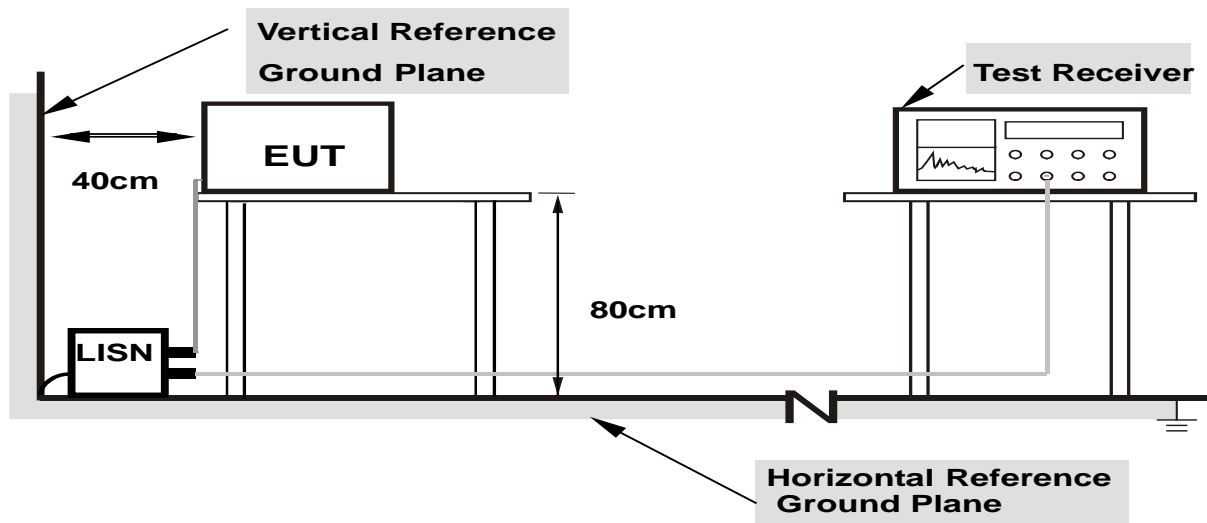

- Note:**
- 1.Support units were connected to second LISN.
  - 2.Both of LISNs (AMN) are 80 cm from EUT and at least 80 from other units and other metal planes

### 3.1.5 EUT OPERATING CONDITIONS

The EUT was configured for testing in a typical fashion (as a customer would normally use it). The EUT has been programmed to continuously transmit during test. This operating condition was tested and used to collect the included data.

### 3.1.6 TEST RESULTS

Temperature :	26 °C	Relative Humidity :	54%
Pressure :	101kPa	Phase :	L
Test Voltage :	AC 24V	Test Mode :	Mode 1

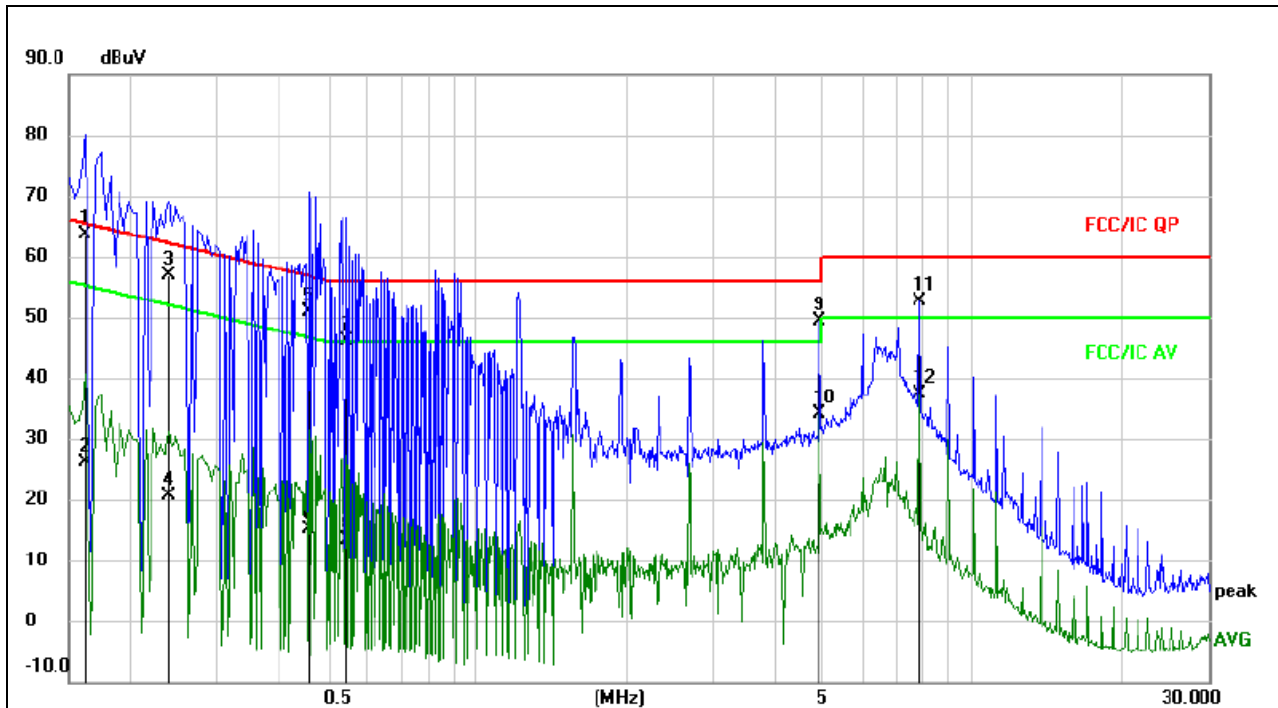

Remark:

1. All readings are Quasi-Peak and Average values.
2. Factor = Insertion Loss + Cable Loss.

No.	Mk.	Freq.	Reading Level	Correct Factor	Measurement	Limit	Over	Detector	Comment
		MHz	dBuV		dBuV	dBuV	dB		
1	*	0.1620	54.06	9.51	63.57	65.36	-1.79	QP	
2		0.1620	16.52	9.51	26.03	55.36	-29.33	AVG	
3		0.2380	47.31	9.51	56.82	62.17	-5.35	QP	
4		0.2380	11.03	9.51	20.54	52.17	-31.63	AVG	
5		0.4560	41.43	9.55	50.98	56.77	-5.79	QP	
6		0.4560	5.55	9.55	15.10	46.77	-31.67	AVG	
7		0.5450	36.32	9.78	46.10	56.00	-9.90	QP	
8		0.5450	3.65	9.78	13.43	46.00	-32.57	AVG	
9		4.9140	39.54	9.79	49.33	56.00	-6.67	QP	
10		4.9140	24.32	9.79	34.11	46.00	-11.89	AVG	
11		7.8180	42.84	9.71	52.55	60.00	-7.45	QP	
12		7.8180	27.61	9.71	37.32	50.00	-12.68	AVG	



Temperature :	26 °C	Relative Humidity :	54%
Pressure :	101kPa	Phase :	N
Test Voltage :	AC 24V	Test Mode :	Mode 1

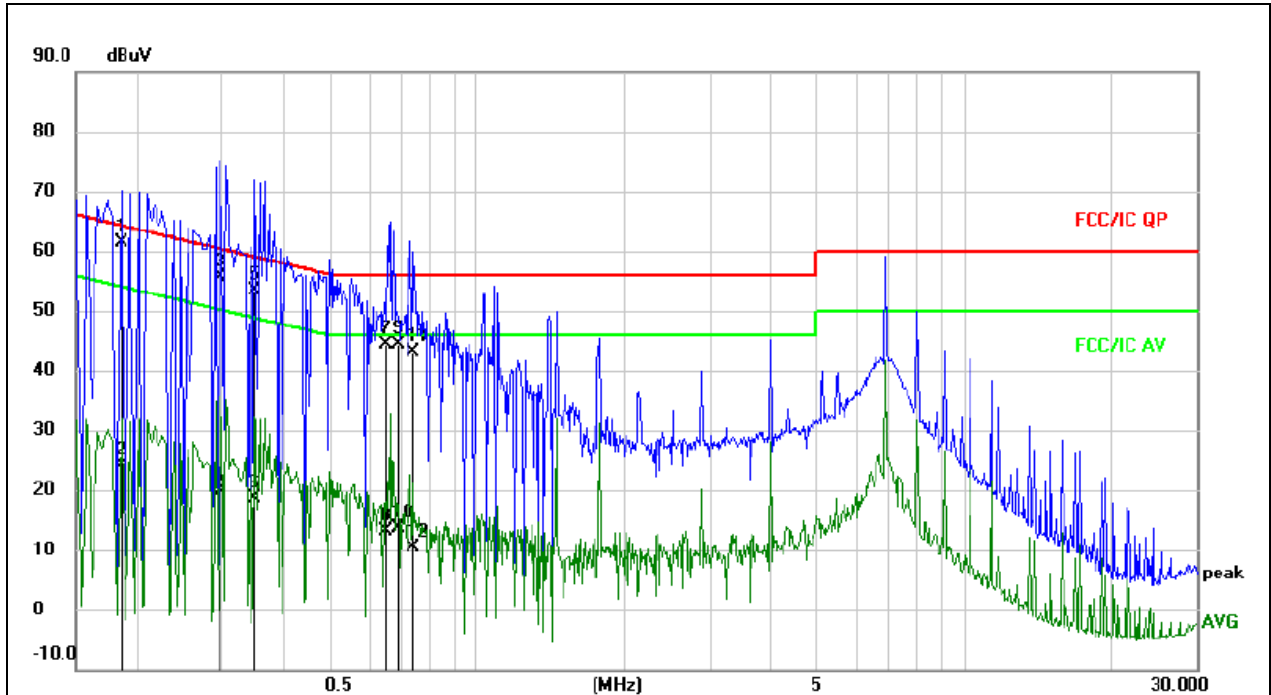

Remark:

1. All readings are Quasi-Peak and Average values.
2. Factor = Insertion Loss + Cable Loss.

No.	Mk.	Freq. MHz	Reading Level dBuV	Correct Factor	Measure- ment dBuV	Limit dBuV	Over dB	Detector	Comment
1	*	0.1870	52.02	9.48	61.50	64.17	-2.67	QP	
2		0.1870	14.67	9.48	24.15	54.17	-30.02	AVG	
3		0.2960	45.98	9.58	55.56	60.35	-4.79	QP	
4		0.2960	10.42	9.58	20.00	50.35	-30.35	AVG	
5		0.3480	43.90	9.54	53.44	59.01	-5.57	QP	
6		0.3480	9.08	9.54	18.62	49.01	-30.39	AVG	
7		0.6510	34.67	9.82	44.49	56.00	-11.51	QP	
8		0.6510	3.37	9.82	13.19	46.00	-32.81	AVG	
9		0.6870	34.76	9.69	44.45	56.00	-11.55	QP	
10		0.6870	3.96	9.69	13.65	46.00	-32.35	AVG	
11		0.7350	33.55	9.64	43.19	56.00	-12.81	QP	
12		0.7350	0.65	9.64	10.29	46.00	-35.71	AVG	



### 3.2 RADIATED EMISSION MEASUREMENT

#### 3.2.1 RADIATED EMISSION LIMITS (Frequency Range 9kHz-1000MHz)

20dBc in any 100 kHz bandwidth outside the operating frequency band. In case the emission fall within the restricted band specified on 15.205(a), then the 15.209(a) limit in the table below has to be followed.

Frequencies (MHz)	Field Strength (micorvolts/meter)	Measurement Distance (meters)
0.009~0.490	2400/F(KHz)	300
0.490~1.705	24000/F(KHz)	30
1.705~30.0	30	30
30~88	100	3
88~216	150	3
216~960	200	3
Above 960	500	3

The field strength of emissions from intentional radiators operated within these frequency bands shall comply with the following:

Fundamental frequency	Field strength of fundamental (millivolts/meter)	Field strength of harmonics (microvolts/meter)
902-928 MHz	50	500
2400-2483.5 MHz	50	500
5725-5875 MHz	50	500
24.0-24.25 GHz	250	2500

#### LIMITS OF RADIATED EMISSION MEASUREMENT (Above 1000MHz)

FREQUENCY (MHz)	Limit (dBuV/m) (at 3M)	
	PEAK	AVERAGE
Above 1000	74	54

Notes:

- (1) The limit for radiated test was performed according to FCC PART 15C.
- (2) The tighter limit applies at the band edges.
- (3) Emission level (dBuV/m)=20log Emission level (uV/m).





Spectrum Parameter	Setting
Attenuation	Auto
Start Frequency	1000 MHz
Stop Frequency	10th carrier harmonic
RB / VB (emission in restricted band)	1 MHz / 1 MHz for Peak, 1 MHz / 10Hz for Average

Receiver Parameter	Setting
Attenuation	Auto
Start ~ Stop Frequency	9kHz~150kHz / RB 200Hz for QP
Start ~ Stop Frequency	150kHz~30MHz / RB 9kHz for QP
Start ~ Stop Frequency	30MHz~1000MHz / RB 120kHz for QP

### 3.2.2 TEST PROCEDURE

- The measuring distance of at 3 m shall be used for measurements at frequency up to 1GHz. For frequencies above 1GHz, any suitable measuring distance may be used.
- The EUT was placed on the top of a rotating table 0.8 meters above the ground at a 3 meter open area test site. The table was rotated 360 degrees to determine the position of the highest radiation.
- The height of the equipment or of the substitution antenna shall be 0.8 m; the height of the test antenna shall vary between 1 m to 4 m. Both horizontal and vertical polarizations of the antenna are set to make the measurement.
- The initial step in collecting conducted emission data is a spectrum analyzer peak detector mode pre-scanning the measurement frequency range. Significant peaks are then marked and then Quasi Peak detector mode re-measured.
- If the Peak Mode measured value compliance with and lower than Quasi Peak Mode Limit, the EUT shall be deemed to meet QP Limits and then no additional QP Mode measurement performed.
- For the actual test configuration, please refer to the related Item –EUT Test Photos.

Note:

Both horizontal and vertical antenna polarities were tested and performed pretest to three orthogonal axis. The worst case emissions were reported

### 3.2.3 DEVIATION FROM TEST STANDARD

No deviation

### 3.2.4 TEST SETUP

#### (A) Radiated Emission Test-Up Frequency Below 30MHz

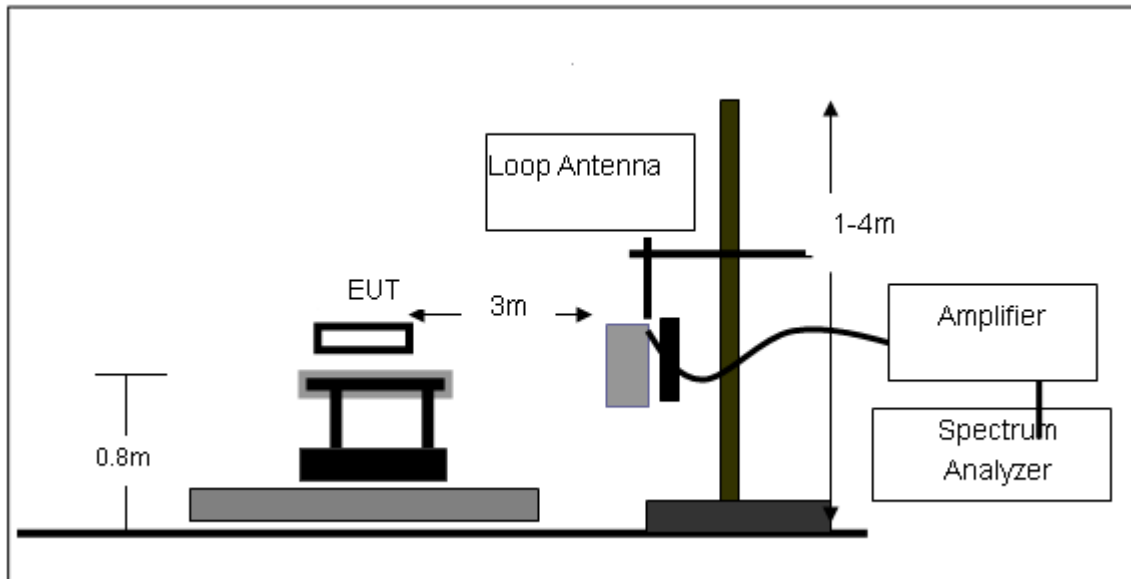

#### (B) Radiated Emission Test-Up Frequency 30MHz~1GHz

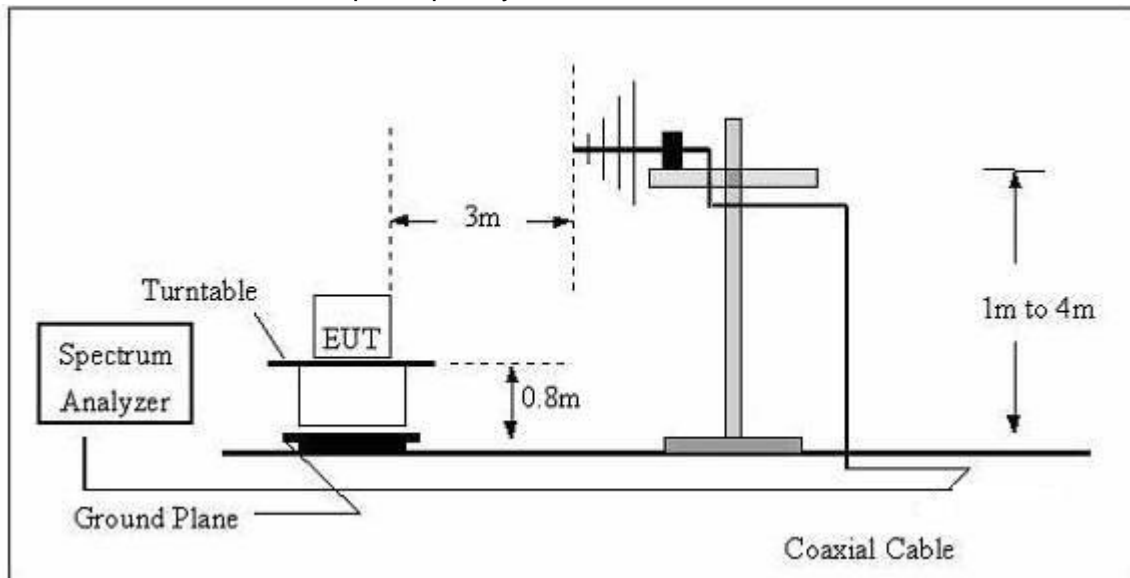

(C) Radiated Emission Test-Up Frequency Above 1GHz

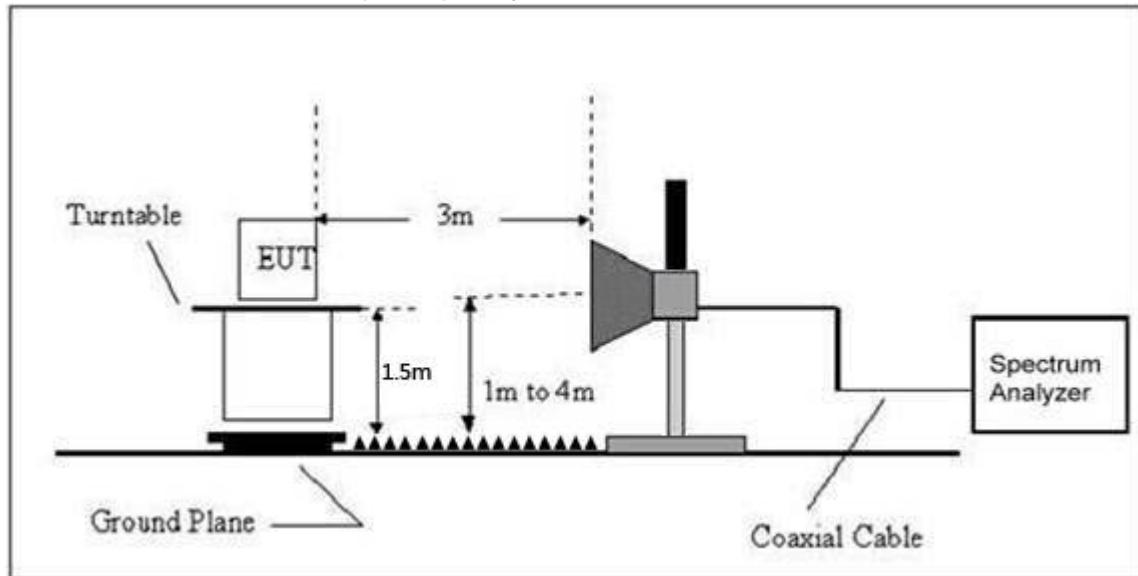

### 3.2.5 EUT OPERATING CONDITIONS

The EUT tested system was configured as the statements of 2.4 Unless otherwise a special operating condition is specified in the follows during the testing.



**3.2.6 TEST RESULTS (BETWEEN 9KHZ – 30 MHZ)**

Temperature:	26°C	Relative Humidity:	54%
Pressure:	101kPa	Test Voltage :	AC24V
Test Mode :	Mode 1	Polarization :	--

Freq. (MHz)	Reading (dBuV/m)	Limit (dBuV/m)	Margin (dB)	State P/F
--	--	--	--	PASS
--	--	--	--	PASS

**NOTE:**

The amplitude of spurious emissions which are attenuated by more than 20dB below the permissible value has no need to be reported.

Distance extrapolation factor =  $40 \log(\text{specific distance/test distance})$ (dB);

Limit line = specific limits(dBuv) + distance extrapolation factor.

**3.2.7 TEST RESULTS (BETWEEN 30MHZ – 1GHZ)**

Temperature :	26℃	Relative Humidity :	54%
Pressure :	101kPa	Polarization :	Horizontal
Test Voltage :	AC24V		
Test Mode :	Mode 1		

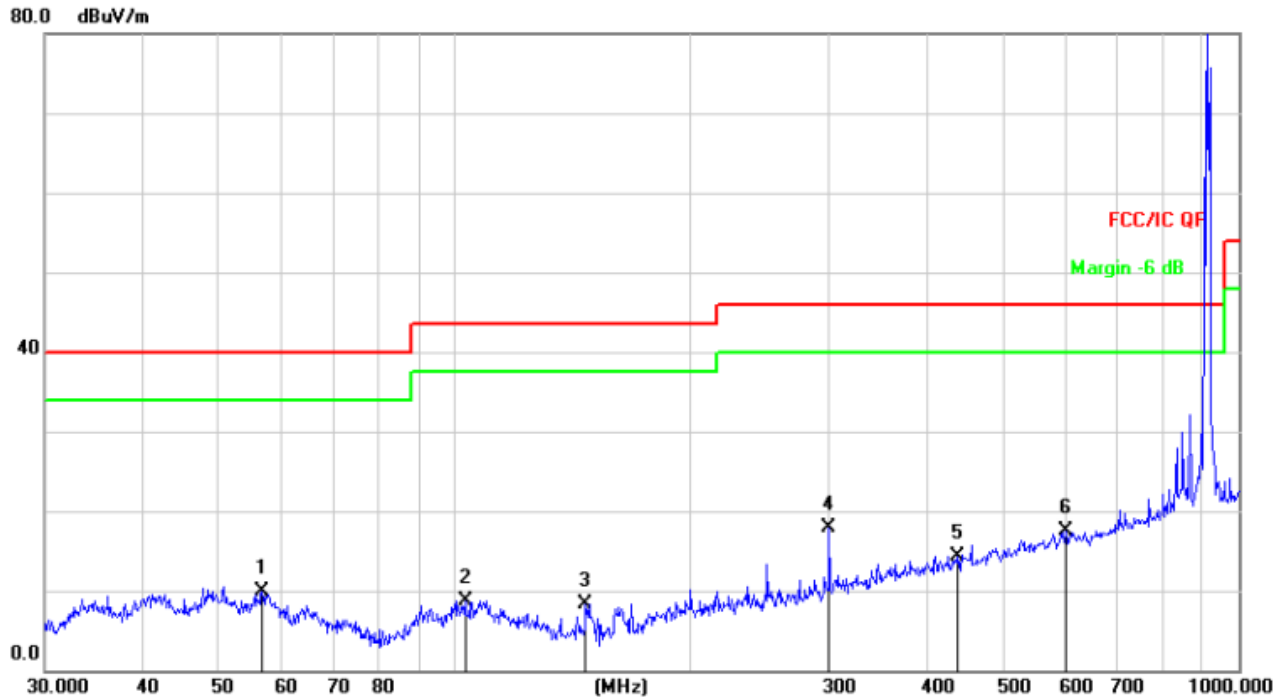

Frequency (MHz)	Meter Reading (dB $\mu$ V)	Factor (dB)	Emission Level (dB $\mu$ V/m)	Limits (dB $\mu$ V/m)	Margin (dB)	Detector Type
56.7917	25.38	-15.57	9.81	40.00	-30.19	
103.0800	25.21	-16.48	8.73	43.50	-34.77	QP
146.8877	27.65	-19.30	8.35	43.50	-35.15	QP
300.3672	31.50	-13.59	17.91	46.00	-28.09	QP
438.6554	24.51	-10.22	14.29	46.00	-31.71	QP
601.4265	24	-6.53	17.47	46.00	-28.53	QP
910.2400	93.86	-1.40	92.46	94.00	-1.54	QP

Remark:

Factor = Antenna Factor + Cable Loss – Pre-amplifier.

All interfaces was connected, and TX mode

Temperature :	26°C	Relative Humidity :	54%
Pressure :	101kPa	Polarization :	Vertical
Test Voltage :	AC24V		
Test Mode :	Mode 1		

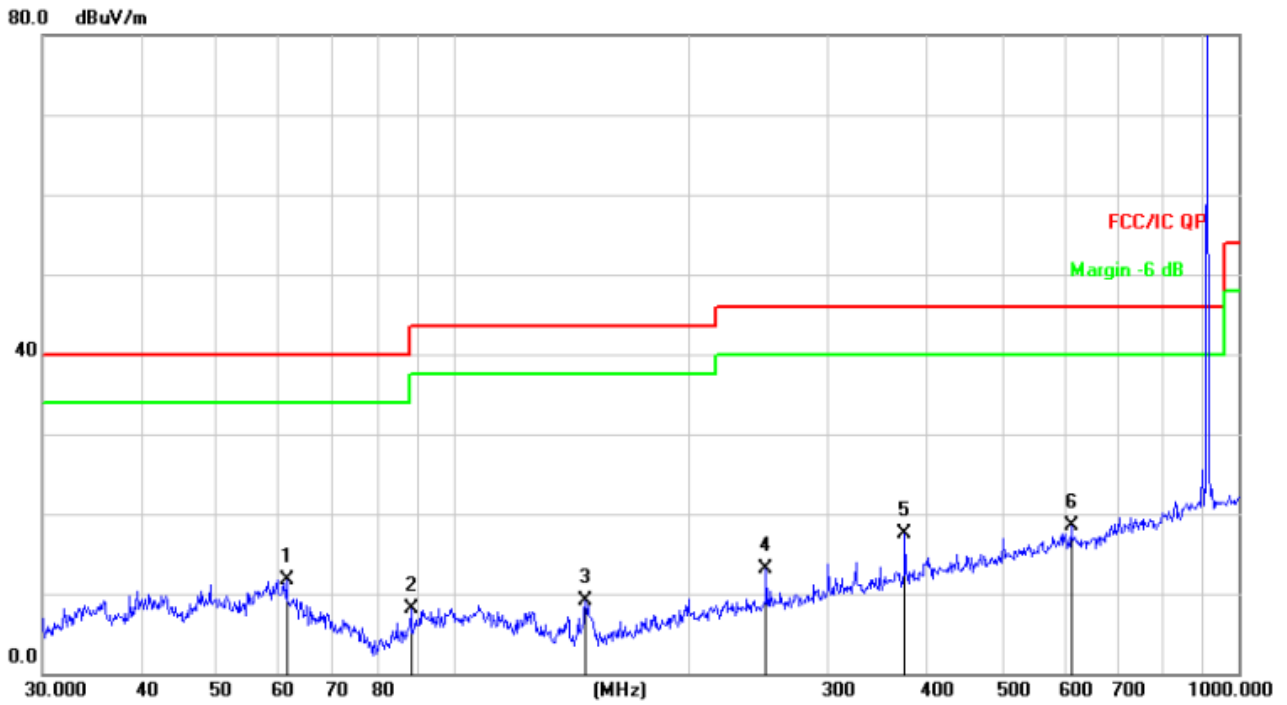

Frequency (MHz)	Meter Reading (dB $\mu$ V)	Factor (dB)	Emission Level (dB $\mu$ V/m)	Limits (dB $\mu$ V/m)	Margin (dB)	Detector Type
61.3463	27.96	-16.22	11.74	40.00	-28.26	QP
88.3421	26.67	-18.48	8.19	43.50	-35.31	QP
147.4036	28.47	-19.33	9.14	43.50	-34.36	QP
250.3012	28.25	-15.14	13.11	46.00	-32.89	QP
375.9385	29.13	-11.64	17.49	46.00	-28.51	QP
612.0642	25.03	-6.59	18.44	46.00	-27.56	QP
910.2400	93.54	-1.40	92.14	94.00	-1.86	QP

Remark:

Factor = Antenna Factor + Cable Loss – Pre-amplifier.

All interfaces was connected, and TX mode



3.2.8 TEST RESULTS (ABOVE 1000 MHZ)

Normal Voltage 910.3MHz

Polar (H/V)	Frequency	Meter Reading	Factor	Emission Level	Limits	Margin	Detector Type
	(MHz)	(dBuV)	(dB)	(dBuV/m)	(dBuV/m)	(dB)	
V	1820.60	59.25	-3.57	55.68	74	-18.32	Pk
V	1820.60	48.21	-3.57	44.64	54	-9.36	AV
V	2730.90	58.42	-3.84	54.58	74	-19.42	Pk
V	2730.90	48.15	-3.84	44.31	54	-9.69	AV
V	3641.20	58.16	-4.59	53.57	74	-20.43	Pk
V	3641.20	48.73	-4.59	44.14	54	-9.86	AV
H	1820.60	61.84	-3.62	58.22	74	-15.78	Pk
H	1820.60	49.51	-3.62	45.89	54	-8.11	AV
H	2730.90	61.79	-3.93	57.86	74	-16.14	Pk
H	2730.90	50.68	-3.93	46.75	54	-7.25	AV
H	3641.20	60.43	-3.57	56.86	74	-17.14	Pk
H	3641.20	48.31	-3.57	44.74	54	-9.26	AV

**Remark:**  
 Absolute Level= ReadingLevel+ Factor, Margin= Limit- Absolute Level  
 Other harmonics emissions are lower than 20dB below the allowable limit.

**CONDUCTED EMISSION MEASUREMENT**

Low Channel 910.3MHz

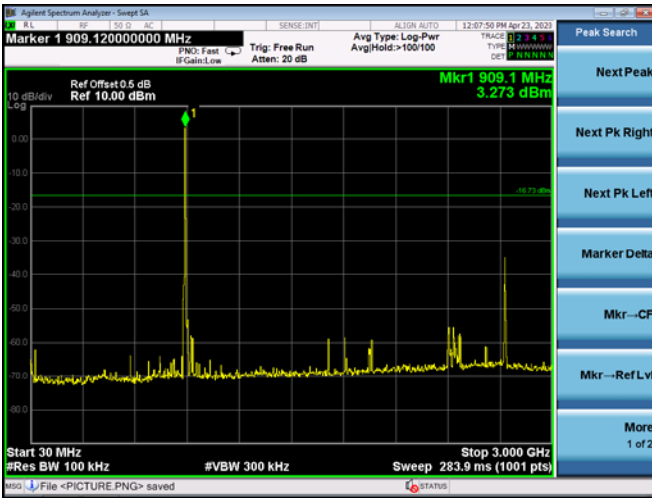





#### **4. 100 KHZ BANDWIDTH OF FREQUENCY BAND EDGE APPLICABLE STANDARD**

Emissions radiated outside of the specified frequency bands, except for harmonics, shall be attenuated by at least 50 dB below the level of the fundamental or to the general radiated emission limits in § 15.209, whichever is the lesser attenuation

#### **TEST PROCEDURE**

- a) Check the calibration of the measuring instrument using either an internal calibrator or a known signal from an external generator.
- b) Position the EUT without connection to measurement instrument. Turn on the EUT and connect its antenna terminal to measurement instrument via a low loss cable. Then set it to any one measured frequency within its operating range, and make sure the instrument is operated in its linear range.
- c) i) VBW for Peak, Quasi-peak, or Average Detector Function:  $3 \times \text{RBW}$
- d) Repeat above procedures until all measured frequencies were complete.

Note:

Both horizontal and vertical antenna polarities were tested and performed pretest to three orthogonal axis. The worst case emissions were reported

#### **4.1 DEVIATION FROM STANDARD**

No deviation.

#### **4.2 TEST SETUP**

#### **4.3 EUT OPERATION CONDITIONS**

The EUT tested system was configured as the statements of 2.4 Unless otherwise a special operating condition is specified in the follows during the testing.

#### **4.4 TEST RESULTS**



Temperature :	26 °C	Relative Humidity :	54%
Pressure :	101 kPa	Test Voltage :	AC24V
Test Mode :	TX Mode		

**910.3MHz Horizontal**

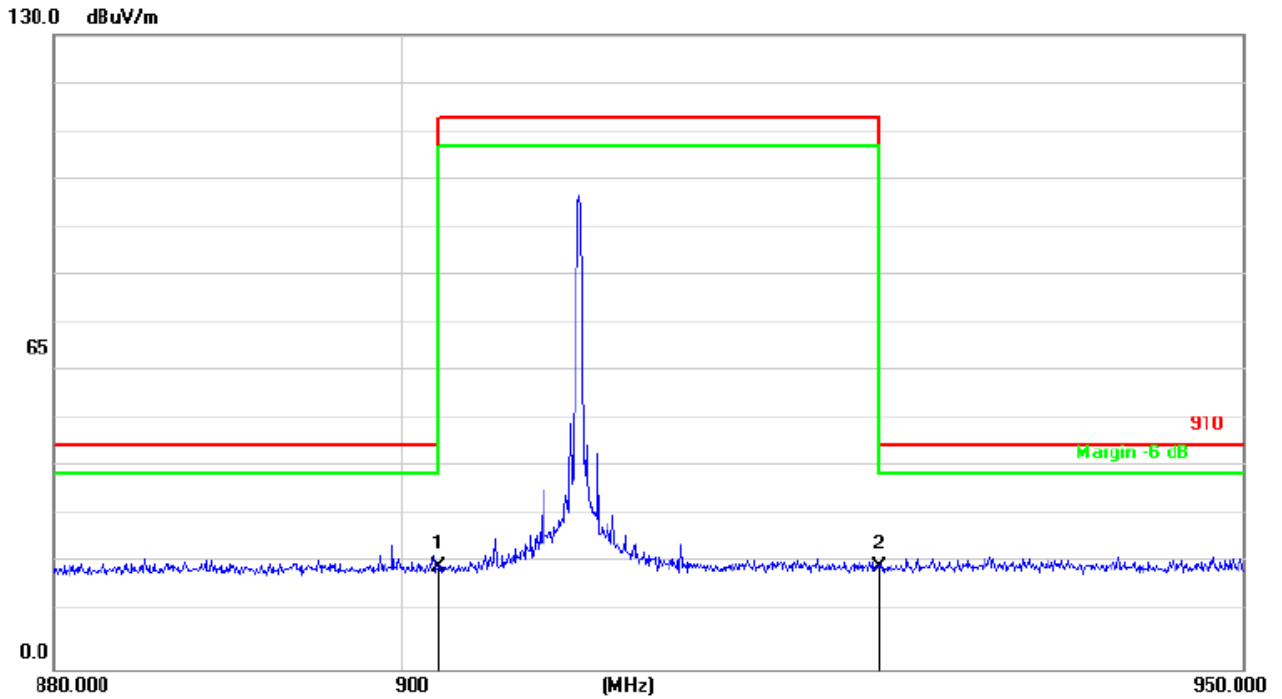

No.	Mk.	Freq.	Reading Level	Correct Factor	Measurement	Limit	Over	Detector
		MHz	dBuV	dB	dBuV/m	dB/m	dB	
1	*	902.0000	22.51	-1.48	21.03	46.00	-24.97	QP
2		928.0000	22.23	-1.28	20.95	46.00	-25.05	QP



910.3MHz Vertical

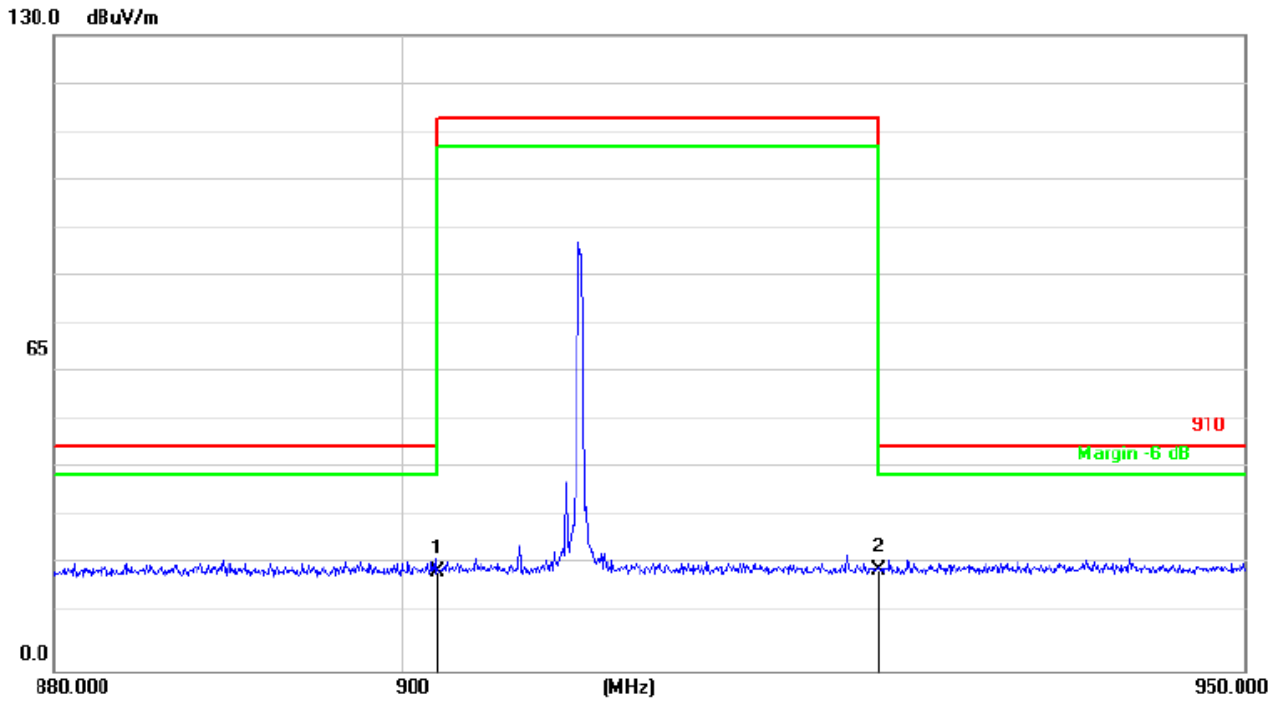

No.	Mk.	Freq. MHz	Reading Level dBuV	Correct Factor dB	Measure- ment dBuV/m	Limit dB/m	Over dB	Detector
1		902.0000	21.65	-1.48	20.17	46.00	-25.83	QP
2	*	928.0000	21.98	-1.28	20.70	46.00	-25.30	QP

## 5. BANDWIDTH TEST

### 5.1 APPLIED PROCEDURES / LIMIT

FCC Part15 (15.249) , Subpart C			
Section	Test Item	Frequency Range (MHz)	Result
15.249	Bandwidth	910.3	PASS

#### 5.1.1 TEST PROCEDURE

1. Set resolution bandwidth (RBW) = 1-5% or DTS BW, not to exceed 100 kHz.
2. Set the video bandwidth (VBW)  $\geq 3 \times$  RBW.
3. Detector = Peak.
4. Trace mode = max hold.
5. Sweep = auto couple.
6. Allow the trace to stabilize.
7. Measure the maximum width of the emission that is constrained by the frequencies associated with the two outermost amplitude points (upper and lower) that are attenuated by 6 dB relative to the maximum level measured in the fundamental emission.

#### 5.1.2 DEVIATION FROM STANDARD

No deviation.

#### 5.1.3 TEST SETUP

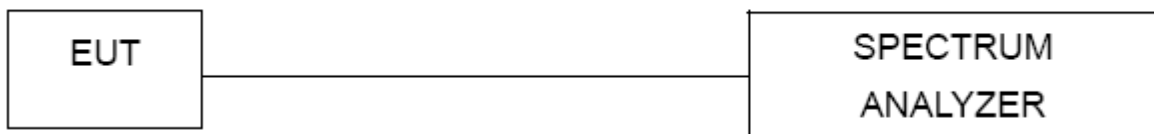

#### 5.1.4 EUT OPERATION CONDITIONS

The EUT tested system was configured as the statements of 2.4 Unless otherwise a special operating condition is specified in the follows during the testing.

### 5.1.5 TEST RESULTS

Temperature :	26°C	Relative Humidity :	54%
Pressure :	101kPa	Test Voltage :	AC24V
Test Mode :	TX Mode		

Channel	Frequency (MHz)	20dB bandwidth (MHz)
01	910.3	0.137

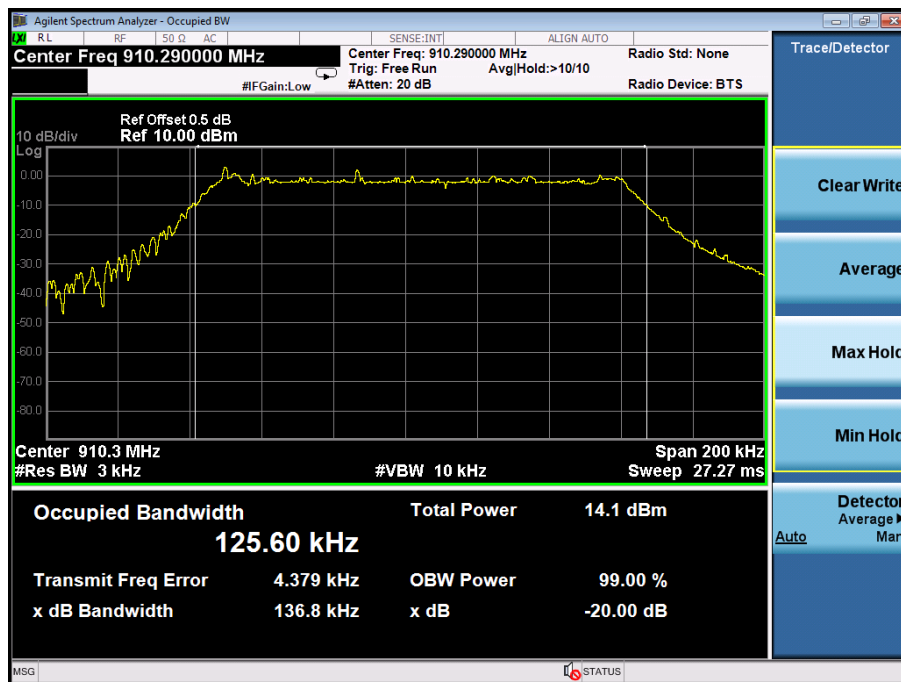



## 6. ANTENNA REQUIREMENT

### 6.1 STANDARD REQUIREMENT

15.203 requirement: For intentional device, according to 15.203: an intentional radiator shall be designed to ensure that no antenna other than that furnished by the responsible party shall be used with the device.

### 6.2 EUT ANTENNA

The EUT antenna is Sping antenna. It comply with the standard requirement.



## 7. EUT TEST PHOTO

### Radiated Measurement Photos

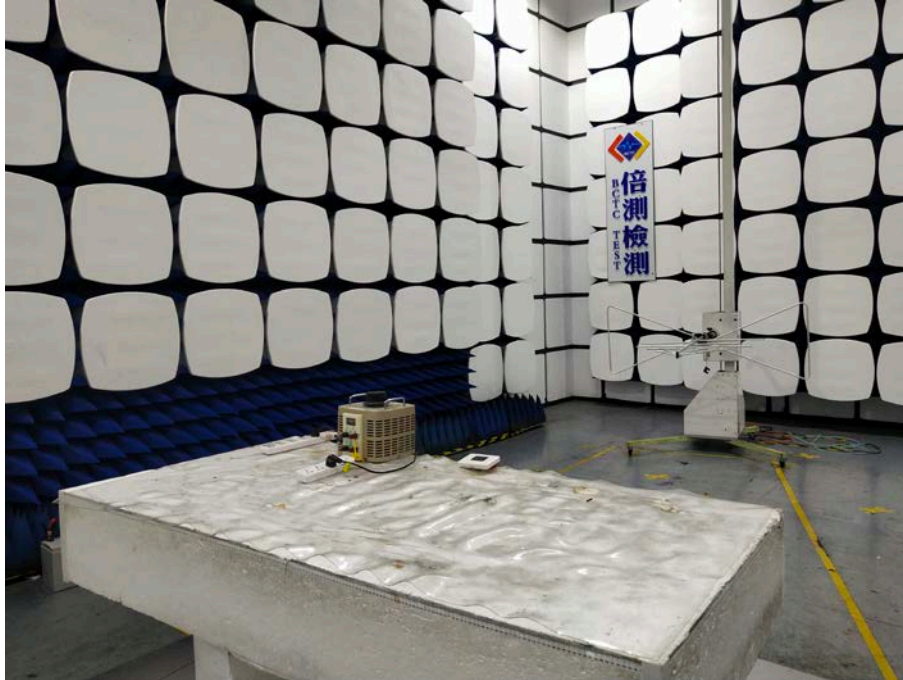



Conducted Measurement Photos







## 8. PHOTO OF THE EUT

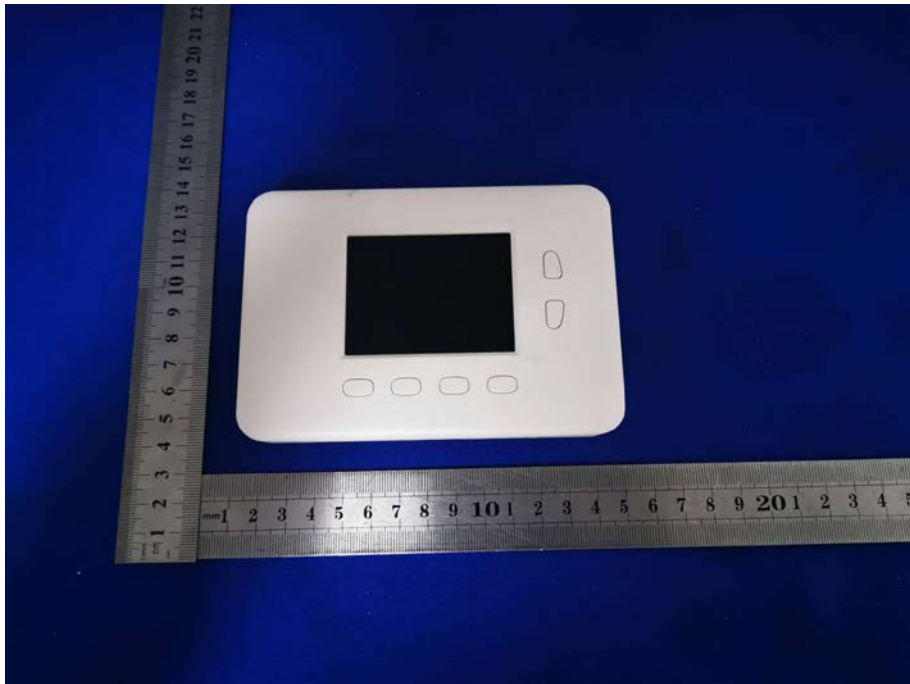

\*\*\*\*\* END OF REPORT \*\*\*\*\*