

YO LINK

YoLink Fob

(FlexFob & AlarmFob)

YS3604-UC

Set-up & User Guide

Rev 1.0

Thank you for purchasing YoLink products and for entrusting us with your smart home needs! Your 100% satisfaction is our goal. If you experience any problems with setting up your new YoLink YoLink Fob (FlexFob or AlarmFob), please give us a chance to assist you, before returning your purchase.

We at Customer Support are here for you. If you need any assistance installing, setting up or using a YoLink product or our app.

Find additional support and ways to reach us at:



www.yosmart.com/support-and-service

Or scan this QR code with your smartphone



Email us, 24/7 at:



service@yosmart.com

Call us, 9AM to 5PM Pacific Standard Time at:



(949) 825-5958

You may chat with us on Facebook (non-urgent matters):



www.facebook.com/YoLinkbyYoSmart



Sincerely,

Queenie, Clair, James, Eric

Customer Support Team

Contents

| | |
|--|----|
| A. In the Box | 1 |
| B. Introduction | 2 |
| C. Set Up | 5 |
| D. Using the YoLink App | 9 |
| E. About Garage Door Control With Fobs | 15 |
| F. Maintenance | 19 |
| G. Specifications | 22 |
| H. Troubleshooting | 24 |
| I . Warning | 25 |
| J . Customer Service & Warranty | 27 |

Revised: 06/24/2021

Copyright © 2021 YoSmart Inc. All rights reserved

A. In the Box

A-1. YoLink FlexFob

- A. YoLink FlexFob
- B. Visor Clip & Wall-Mount Bracket
- C. Quick Start Guide

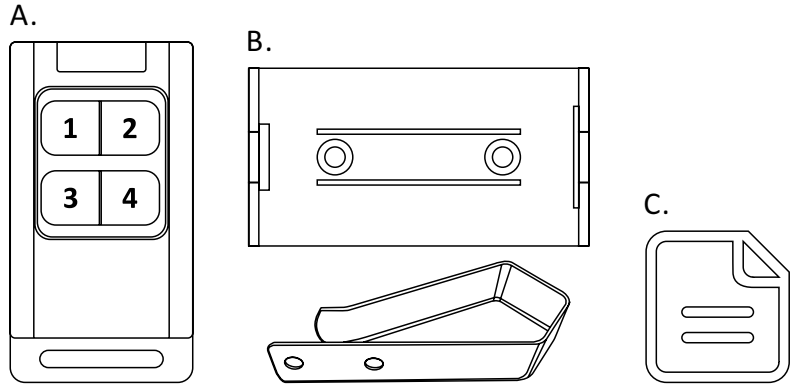

A-2. YoLink AlarmFob

- A. YoLink AlarmFob
- B. Visor Clip & Wall-Mount Bracket
- C. Quick Start Guide

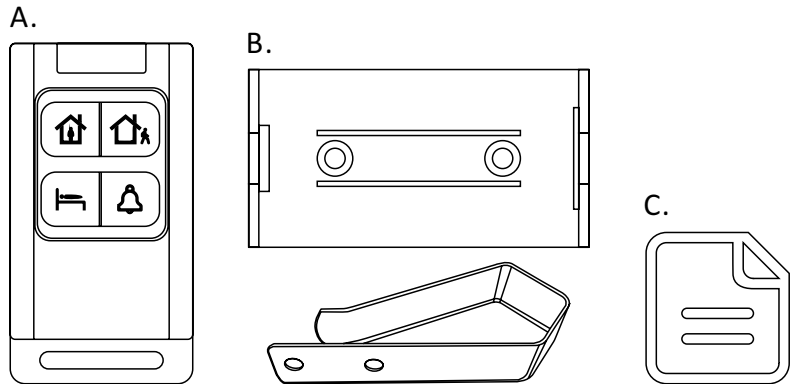

B. Introduction

B-1. FlexFob

The YoLink FlexFob is a smart remote that can flexibly design actions* for each button through YoLink app, control desired actions with the YoLink app on your smartphone or tablet or using the associated button on the device.

* Desired actions includes enable/disable alarm strategy, scene control (Away, Home, Arm, Disarm, etc.), enable/disable automation, trigger action devices (according to Automation setting), etc.

Status LEDs

LEDs are off when the fob is in a normal status

1-4 Buttons

short press (click) / long-press the associated button to run the actions

- Audible Status Feedback

One Beep: Action Successfully Ran

Three Beeps: Action Not Successfully Ran

Key Ring Slot

Attach the fob to a key ring, if desired

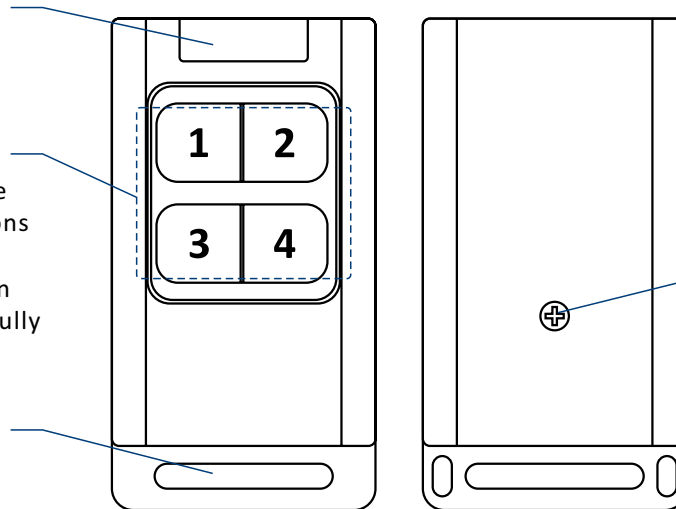

Battery Compartment Screw

Compartment houses two LR44 non-rechargeable button batteries

B-2. AlarmFob

The YoLink AlarmFob is a smart remote with four programmable buttons, each capable of performing two pre-set actions*, as defined by the user, using the YoLink app. The actions assigned to each button can be initiated from the app, as well as from the fob (refer to “Using the YoLink App” section for additional information)

*Examples of actions include enabling or disabling an alarm strategy or automation, scene control (Home, Away, Arm, Disarm, etc.), and triggering action devices (according to Automation settings), etc.

Status LEDs

LEDs are off when the fob is in a normal status

Four Buttons with Pre-Set Actions

Short press (click) or long-press the associated button to run the actions
There are four pre-set behaviors for each button

- Audible Status Feedback

One Beep: Action Successfully Ran





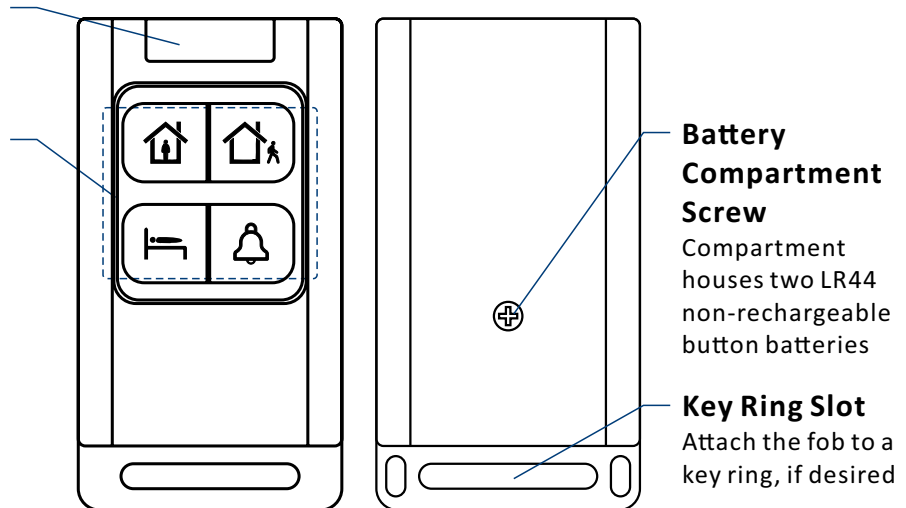

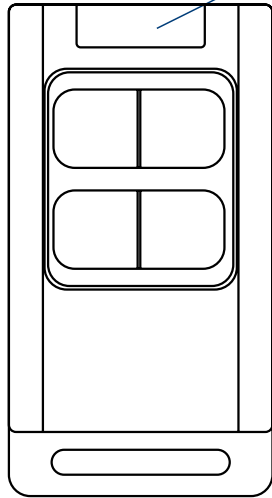

Three Beeps: Action Not Successfully Ran

Ran



The LED light indicates the current status of the YoLink Fob (FlexFob / AlarmFob):



-  **Blinking Red Once, Then Green Once**
Device Turned On
-  **Blinking Red And Green Alternately**
Restoring to Factory Defaults
-  **Blinking Green Once**
One-click/Long Press (0.5-2s) a Key
-  **Slow Blinking Green Once**
Actions Run Succeeded
-  **Blinking Green**
Connecting to Cloud
-  **Slow Blinking Green**
Updating
-  **Slow Blinking Red Once**
Actions Run Failed
-  **Fast Blinking Red Every 30 Seconds**
Batteries are Low; Please Replace the Batteries (*see page 21*)

C. Set Up

C-1. Set Up - First-Time YoLink Users *(Existing users proceed to C-2. Add Device, next page)*

- 1 Download the YoLink app through Apple App Store or Google Play Store (Search in the store or use the QR code on the right)



!
Apple iPhone or tablet that is iOS 9.0 or higher, or an Android phone or tablet that is Android 4.4 or higher

- 2 Log in to the YoLink app



Create a new account if required

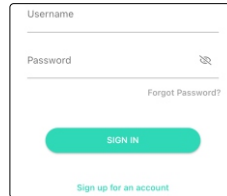

!
1. Make sure your Hub is connected to the internet (green LED indicator is blinking, blue LED indicator is always on)

- 3 The YoLink Hub is required to set up your YoLink Fob (FlexFob / AlarmFob). Please set up your YoLink Hub first (refer to YoLink Hub manual)

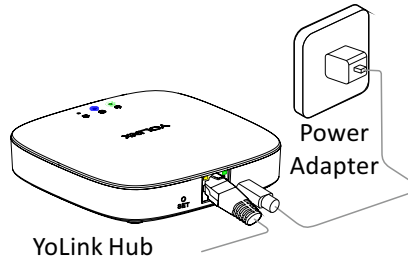

2. Ethernet patch cable (included) to your network (router, switch, etc.), **recommended**. Otherwise connect your Hub to your home 2.4 GHz Wi-Fi network (only when necessary). Refer to the Hub set up manual for more information:



YS1603-UC
User Guide

C-2. Add Device

- 1 Tap “” button, then scan QR Code on the device. Follow the steps to add the device

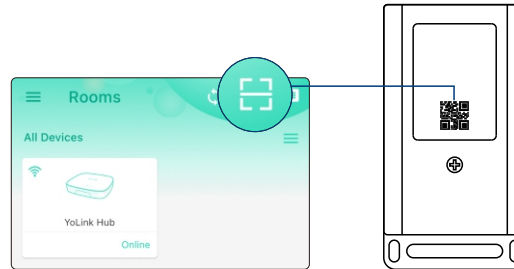

-
- 2 Press any of the four buttons once to turn on the device. The Status LED will blink red once, then green several times, indicating your device has connected to the cloud and is ready to use

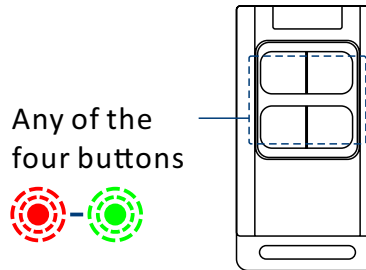

1. You will need to press any of the four buttons once again if the device failed to connect to the cloud
2. Pressing any of the four buttons at any other time after this initial process will result in the LED blinking green once, only. This indicates the device is connected to the cloud and is functioning normally
3. If the red LED does NOT blink as noted this may indicate a problem with the Fob. Please see the troubleshooting section and the contact section for technical support

C-3. Device Placement



Do not place the fob on or near sources of extreme heat or cold

Your fob is designed to be portable, but in addition to its common use on a keyring, your fob comes with a wall-mount bracket as well as a car visor clip

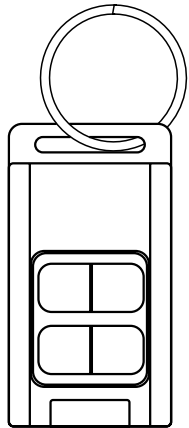
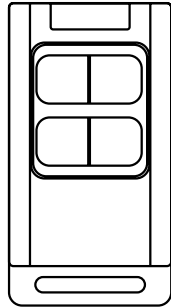

b. Add the fob to your keyring, so that it is always with your keys

a. Wall-mounting: The wall-mount bracket allows for placing the fob on a wall or other vertical location (e.g. side of nightstand or bed). Securely attach the bracket to the surface using suitable fasteners or material such as 3M brand mounting tape

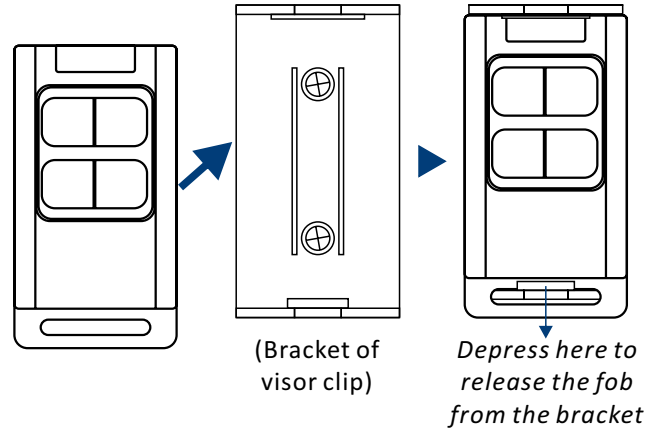

c. Use the visor clip with the wall-mount bracket to place your fob on your car's visor

① Insert the fob into the bracket

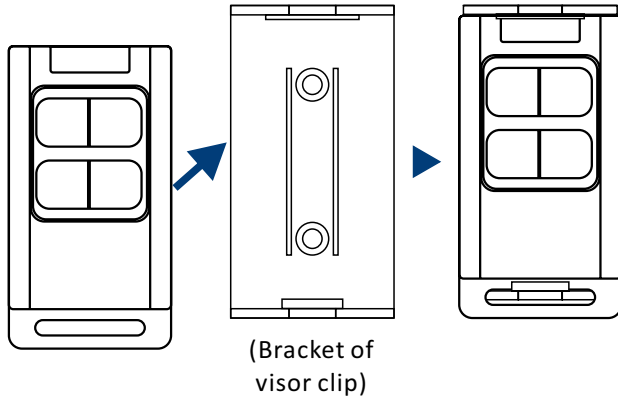

② Insert visor clip into the slot on the back of the bracket, as shown

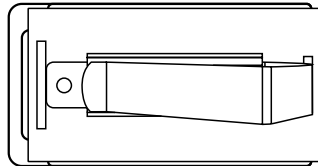

③ Place the visor clip on to your car visor

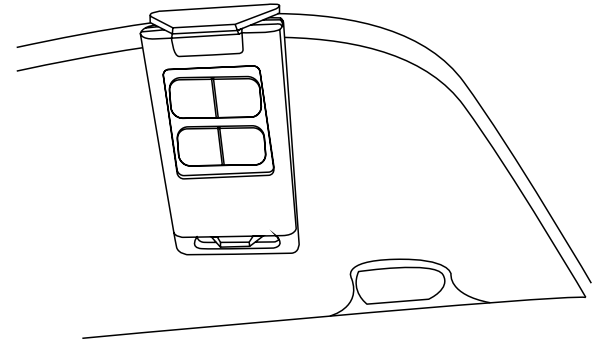

D. Using the YoLink App

D-1. Device Page

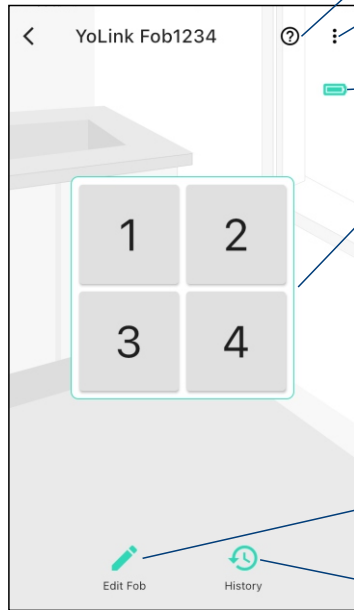

(FlexFob)

- Tap to get device manual link, feedback, contact us information, etc.



Details

- Tap to go to Details page (refer to page 11)



Battery Level of YoLink Fob

- Shown red if battery level is low



Control the Buttons

- There are two control methods:

- Press the button to activate the related action
- Long press the button to activate the related action

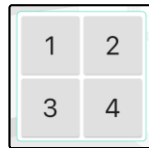

Edit the Buttons

- Tap to edit the buttons (refer to page 12)



Device Action History

Historical log of button-controlled, logged with associated button and the action, date & time



Before using the fob, please choose "confirm" to confirm the initial settings

- Tap to get device manual link, feedback, contact us information, etc.

Details
- Tap to go to Details page (refer to page 11)

Battery Level of YoLink Fob
- Shown red if battery level is low

Control the Buttons
- There are two control methods:
a. Press the button to activate the related action
b. Long press the button to activate the related action

Edit the Buttons
- Tap to edit the buttons (refer to page 12)

Device Action History
Historical log of button-controlled, logged with associated button and the action, date & time

(AlarmFob)

! Before using the fob, please choose “confirm” to confirm the initial settings

D-2. Details Page

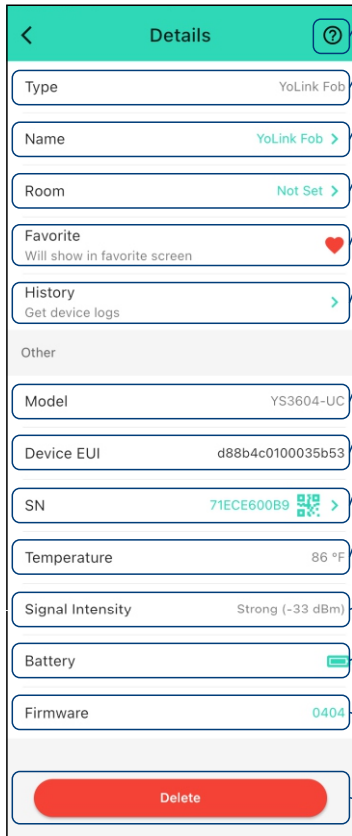

- Tap to get device manual link, feedback, contact us information, etc.

a. Device Type

b. Rename the Device

c. Choose a Room for device

d. Add/Remove from favorites

e. Device Action History

Historical log of button-controlled, logged with associated button and the action, date & time

f. Device Model

g. Device EUI (unique)

h. Device SN (unique)

i. Temperature Value

- Updates when:

1. SET button pressed;
2. On a device alert;
3. Batteries are replaced;
4. Automatically within 4 hours maximum

j. Connection Signal Intensity of sensor and Hub

k. Current Battery Level

- Shown red if battery level is low

l. Firmware Version

- "#### ready now" indicates a new update is available (refer to page 19)

m. Remove Device From Current Account

- Tap to delete the device from your YoLink account

D-3. Edit the Buttons



You can assign a scene or automation assigned to any of the four buttons in the app, but you can not add the garage controller as an action. This is for safety reasons, to prevent accidental operation of the door

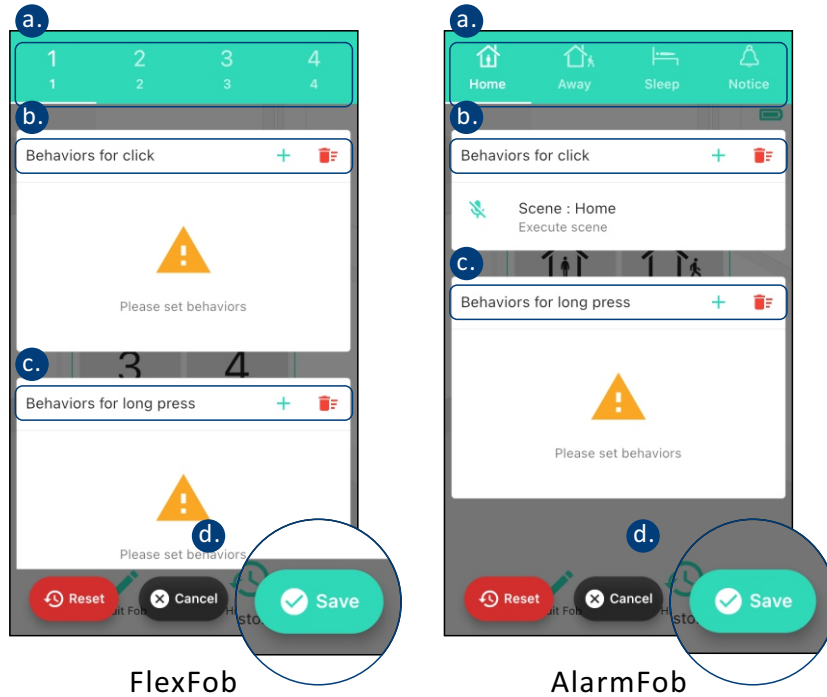

a. Tap the fob button that you want to edit

b. Tap the “+” icon to add a click (short-press) behavior

c. Tap the “+” icon to add a long press behavior

d. Tap to save the settings

-Tap "Reset" to restore the settings to factory default (any changes you've made will not be saved);

Tap "Cancel" to exit changing settings (any changes you've made will not be saved)

For AlarmFob:

Fob is pre-configured with a click behavior for each of the four buttons. You can edit each behavior in the associated scene (refer to page 13)



D-4. Scene

Go to the “Smart” screen (default view is “Scene” screen)



There are four pre-set scenes, you can choose to either edit or delete each of them

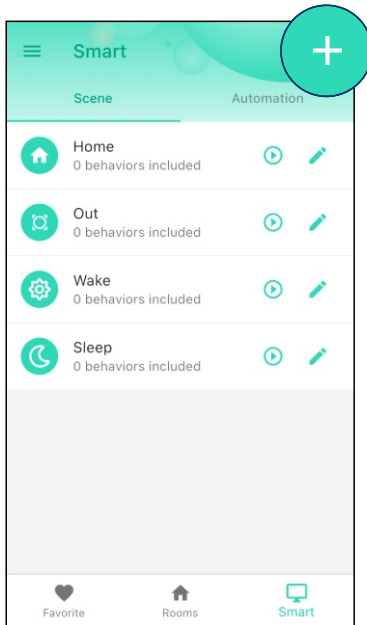

a. Tap the “+” icon to add a scene

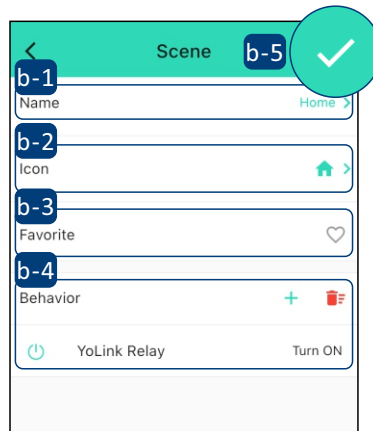

b. Add a scene

b-1 Edit name

b-2 Select an icon

b-3 Add/remove from favorites

b-4 Edit behavior (*You must have at least one action device, or you cannot set a behavior*)

b-5 Tap to save the settings

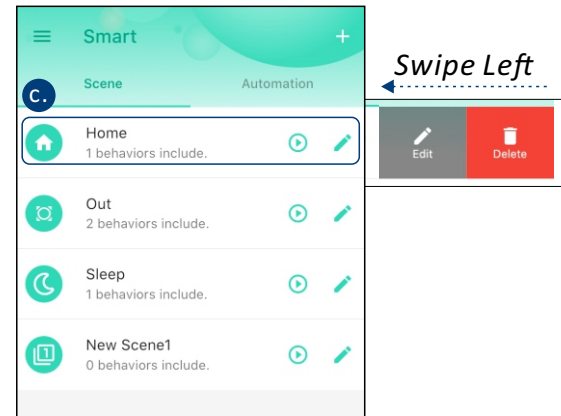

c. Click to edit the scene

1. Tap “⏪” button to run the scene

2. Tap “✎” button to edit the scene

3. Swipe left to edit or to delete the scene

D-5. Third-Party Services

With third-party services connected to your YoLink account, your fob can trigger automations, routines and applets with smart home/IoT devices and services from third-party (non-YoLink) brands

- Tap “☰” in the upper left corner to go to My Profile
- Go to **Settings > Third-Party Services** and select the applicable service
- Follow the instructions, to authorize and add the connection to your YoLink account

Refer to the associated app or website for additional information specific to the third-party service. Additional information may also be found on our website at www.yosmart.com/support-and-service or by contacting Customer Support (refer to page 27 for contact information)



D-5-1. IFTTT

The YoLink Fob buttons can be used as a trigger for custom applets. Visit www.ifttt.com for more information and pricing

D-5-2. Alexa



The Alexa integration is under development as of the date this manual was produced

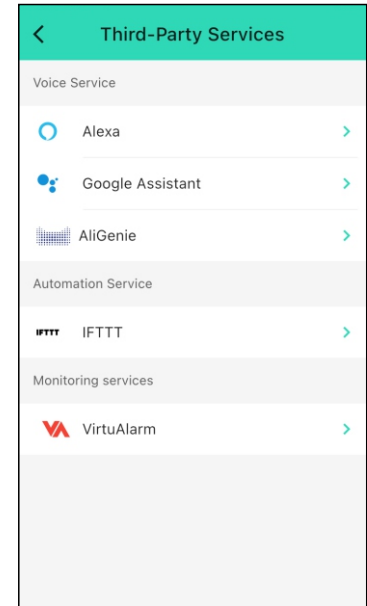

E. About Garage Door Control With Fobs (*Physical Button Control, Only*)

Pair your YoLink Fob with the YS4906-UC Garage Door Controller or YS4908-UC YoLink Finger. When you press the associated button, the YoLink Finger will operate (it will open or close, depending on the current status of the door)

! You can assign a scene or automation assigned to any of the four buttons in the app, but you can not add the garage controller as an action. This is for safety reasons, to prevent accidental operation of the door

E-1. Pair YoLink Fob with YS4906-UC Garage Door Controller

E-1-1. Pairing

- 1 Choose the fob button you will use for control of the Garage Door Controller. Hold this button for 5-10 seconds until the LED quickly blinks green. Then, release the button
- 2 Press and hold the SET button on the YoLink Finger for 5-10 seconds until the LED quickly blinks green. Then, release the button
- 3 Upon pairing, the LED will stop blinking (this may happen after only blinking two or three times)

! Holding the button longer than 10 seconds will ABORT the pairing operation

a. Any of the four buttons (5-10 seconds)

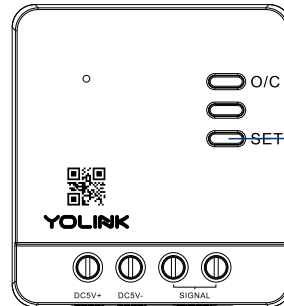
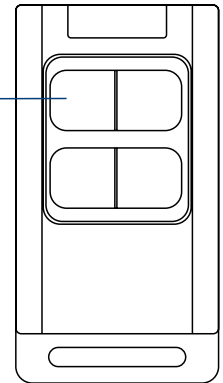

b. SET button (5-10 seconds)



E-1-2. Operation

- When you press the associated button, the Garage Door Controller will operate (it will open or close, depending on the current status of the door)

! To avoid injury or damage, only press the button when the garage door area is clear of people and objects

E-1-3. Unpairing

- 1 Press and hold the associated button on the YoLink Fob that you paired with the garage door controller for 10-15 seconds until the LED quickly blinks green, then red, release the button

!
Holding the button longer than 15 seconds will ABORT the unpairing operation

- 2 Press and hold the SET button on the paired Garage Door Controller for 10-15 seconds until the LED quickly blinks green, then red, release the button
- 3 Upon up-pairing, the LED will stop blinking (this may happen after only blinking two or three times)
- 4 The Garage Door Controller will no longer open or close the garage door when you press the associated button

a. Any of the four buttons
(10-15seconds)

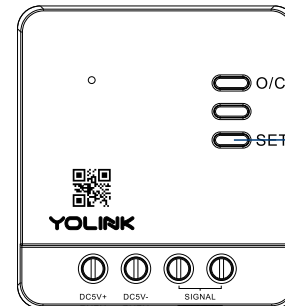
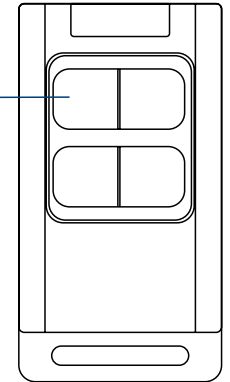

b. SET button
(10-15 seconds)



E-2. Pair YoLink Fob with YS4908-UC YoLink Finger (Garage Controller)

E-2-1. Pairing

- 1 Choose the fob button you will use for control of the Finger. Hold this button for 5-10 seconds until the LED quickly blinks green. Then, release the button
- 2 Press and hold the SET button on the YoLink Finger for 5-10 seconds until the LED quickly blinks green. Then, release the button
- 3 Upon pairing, the LED will stop blinking (this may happen after only blinking two or three times)

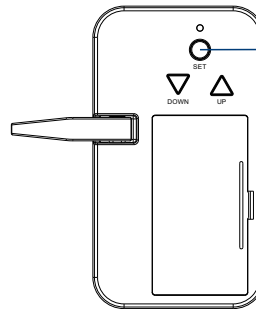

Holding the button longer than 10 seconds will ABORT the pairing operation



a. Any of the four buttons (5-10 seconds)

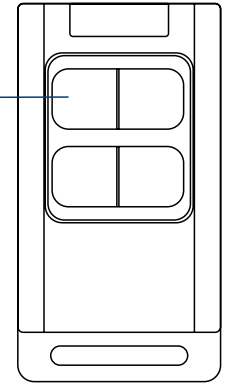

b. SET button (5-10 seconds)



E-2-2. Operation

- When you press the associated button, the YoLink Finger will operate (it will open or close, depending on the current status of the door)



To avoid injury or damage, only press the button when the garage door area is clear of people and objects

E-2-3. Unpairing

- 1 Press and hold the associated button on the YoLink Fob that you paired with the YoLink Finger for 10-15 seconds until the LED quickly blinks green, then red, release the button
- 2 Press and hold the SET button on the paired YoLink Finger for 10-15 seconds until the LED quickly blinks green, then red, release the button
- 3 Upon up-pairing, the LED will stop blinking (this may happen after only blinking two or three times)
- 4 The YoLink Finger will no longer open or close the garage door when you press the associated button

Holding the button longer than 15 seconds will ABORT the unpairing operation

a. Any of the four buttons
(10-15seconds)

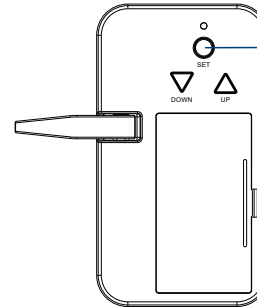
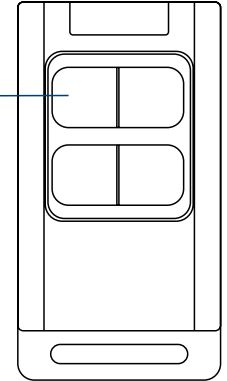

b. SET button
(10-15 seconds)



F. Maintenance

F-1. Firmware Update

To ensure our customers have the best user experience, we highly recommend you update to the newest version firmware when an update is available

- In “Firmware”, if a new version is listed as available (#### ready now), click it to start the firmware update process
- The device’s firmware will be updated automatically within 4 hours (maximum). To force an immediate update, press the SET button on the device once to make the device enter update mode
- You may use your device during the update as it is performed in the background. The LED light will slowly blink green during the update and the process will be complete within 2 minutes after the light stops blinking

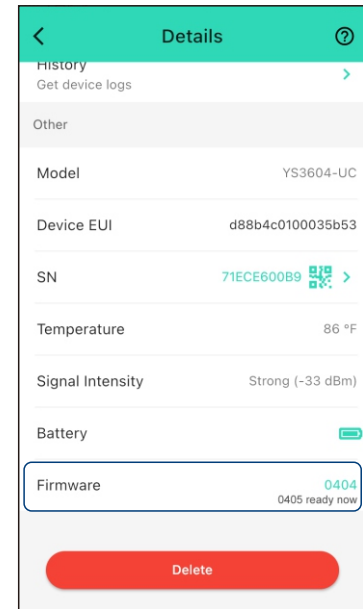
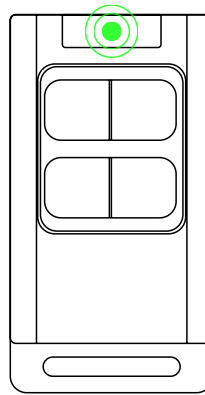

F-2. Factory Reset

Factory reset will erase all of your settings and restore it to factory defaults. After the factory reset, your device will remain in your Yolink account

- Holding the left bottom button for 20-25 seconds until the status light blinks red and green alternately, then, release the button (*Hold the button longer than 25 seconds will ABORT the factory reset operation*)
- Factory reset will be complete when the status light stops blinking

The left bottom button
(20-25 seconds)

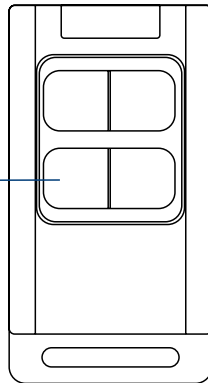

F-3. Replace the Batteries

- 1 Remove the housing screw, carefully place it aside

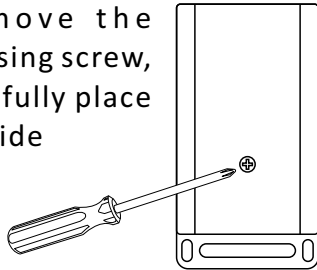

- 2 Remove the back shell

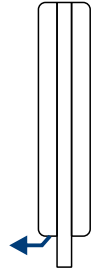

- 3 Take out the hardware from the back shell, then remove the two LR44 batteries using a screwdriver

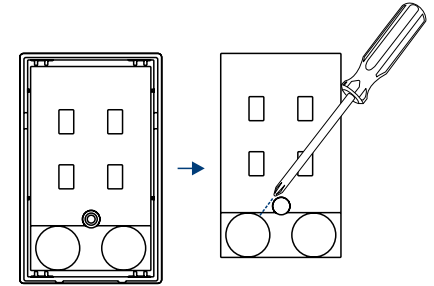
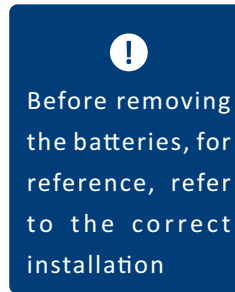

- 4 Observing polarity (keep the “+” mark above), insert two new LR44 batteries and push the batteries completely inside the compartment

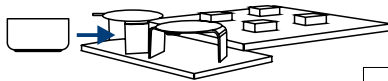

Do not mix old and new batteries

2 x LR44

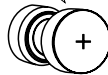

- 5 Reassemble the fob and tighten the screw

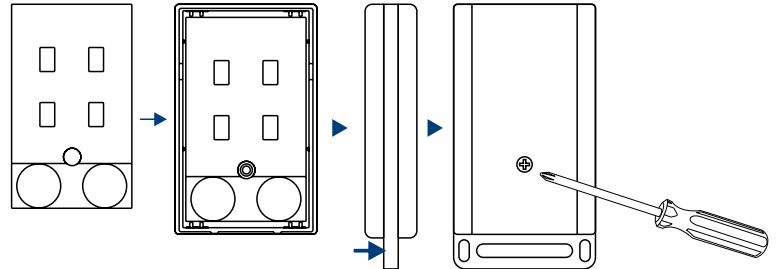

- 6 Using the app, check the online status of the fob and verify there is no low-battery indicator

G. Specifications

Battery: 3V DC (two LR44 button batteries)

Device Current Draw: $\leq 135\text{mA}$ (on), $\leq 2\mu\text{A}$ (standby)

Environment: Working Temperature: -4°F - 122°F (-20°C - 50°C)
(optimal for 2+ year battery life: 50°F - 122°F (10°C - 50°C))
Working Humidity: $\leq 95\%$, non-condensing

Dimensions:

Unit: inches (millimeters)

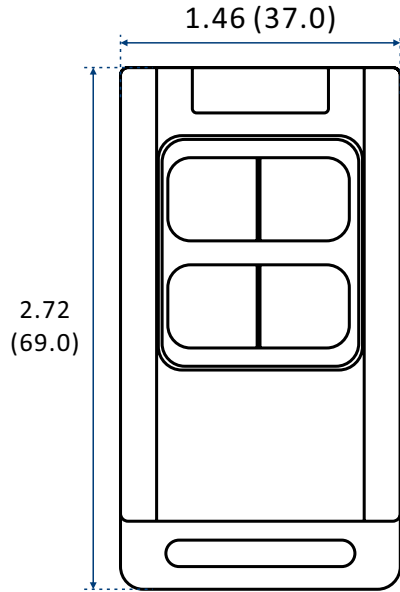

FRONT

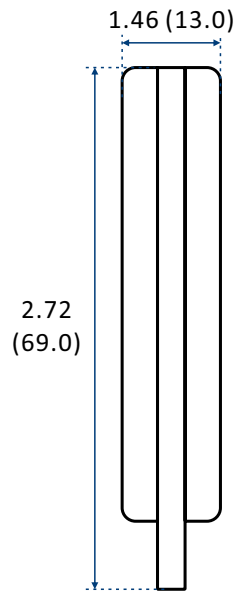

SIDE

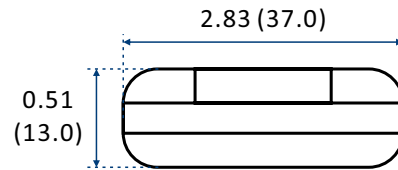

TOP

H. Troubleshooting

Symptom:

1. Buttons not working or not working consistently

- If fob is not connected to the cloud, press the associated button on YoLink Fob once
- If Hub is offline, reconnect the Hub to the Internet and press the associated button on YoLink Fob once
- If Hub is not on, power on the Hub again and the associated button on YoLink Fob once
- If fob is out of range with Hub, relocating the Hub may be required
- For a device with low-battery indicators or alerts or if the condition of the batteries is in question, replace the batteries with two new LR44 button batteries

2. Other issues, contact customer service, **1-949-825-5958 (M-F 9am - 5pm PST)** or email 24/7 at **service@yosmart.com**

I. Warning

- Please install, operate and maintain the YoLink Fob only as outlined in this manual. Improper use may damage the unit and/or void the warranty
- Use only new, name brand, LR44 button batteries
- Do not use zinc blend batteries
- Do not mix new and old batteries
- Do not puncture or damage batteries. Leakage can cause harm on skin contact, and is toxic if ingested
- Do not dispose of batteries in fire as they may explode! Please follow local battery disposal procedures
- It is recommended to use the device in an indoor temperature environment, only. Battery life can be significantly reduced if the device is used in environments below 50°F (10°C)
- This device is not waterproof and is designed and intended only for indoor use. Subjecting this device to outdoor environment conditions such as direct sunlight, extreme hot or cold temperatures, rain, water and/or condensation can damage the device and will void the warranty
- Do not install or use this device where it will be subjected to high temperatures and/or open flame
- Install or use this device only in clean environments. Extremely dusty or dirty environments may prevent the proper operation of this device, and will void the warranty

- If your YoLink Fob does get dirty, please clean it by wiping it down with a clean, dry cloth. Do not use strong chemicals or detergents, which may discolor or damage the exterior and/or damage the electronics, voiding the warranty
- Do not install or use this device where it will be subjected to physical impacts and/or strong vibration. Physical damage is not covered by the warranty
- Please contact Customer Service before attempting to repair disassemble or modify the device, any of which can void the warranty and permanently damage the device

If you have any difficulties installing or using YoLink products, please contact our Customer Service department during business hours:

US Live Tech Support: **1-949-825-5958** M-F 9am - 5pm PST

Email: **service@yosmart.com**

YoSmart Inc. 15375 Barranca Parkway, Ste G-105 Irvine, CA 92618, USA

Warranty 2 Year Limited Electrical Warranty

YoSmart warrants to the original residential user of this product that it will be free from defects in materials and workmanship, under normal use, for 2 year from the date of purchase. User must provide a copy of original purchase receipt. This warranty does not cover abuse or misused products or products used in commercial applications. This warranty does not apply to devices that have been improperly installed, modified, put to a use other than designed, or subjected to acts of God (such as floods, lightning, earthquakes, etc.). This warranty is limited to repair or replacement of the device only at YoSmart's sole discretion. YoSmart will NOT be liable for the cost of installing, removing, nor reinstalling this product, nor direct, indirect, or consequential damages to persons or property resulting from the use of this product. This warranty only covers the cost of replacement parts or replacement units, it does not cover shipping & handling fees

To implement this warranty please give us a call during business hours at 1-949-825-5958, or visit www.yosmart.com

FCC Caution:

This device complies with part 15 of the FCC Rules. Operation is subject to the following two conditions: (1) This device may not cause harmful interference, and (2) this device must accept any interference received, including interference that may cause undesired operation.

Any Changes or modifications not expressly approved by the party responsible for compliance could void the user's authority to operate the equipment.

Note: This equipment has been tested and found to comply with the limits for a Class B digital device, pursuant to part 15 of the FCC Rules. These limits are designed to provide reasonable protection against harmful interference in a residential installation. This equipment generates uses and can radiate radio frequency energy and, if not installed and used in accordance with the instructions, may cause harmful interference to radio communications. However, there is no guarantee that interference will not occur in a particular installation. If this equipment does cause harmful interference to radio or television reception, which can be determined by turning the equipment off and on, the user is encouraged to try to correct the interference by one or more of the following measures:

- Reorient or relocate the receiving antenna.
- Increase the separation between the equipment and receiver.
- Connect the equipment into an outlet on a circuit different from that to which the receiver is connected.
- Consult the dealer or an experienced radio/TV technician for help.

The device has been evaluated to meet general RF exposure requirement. The device can be used in portable exposure condition without restriction.