

TEST REPORT

Report No.: BCTC2212747219-2E

Applicant: YoSmart Inc.

Product Name: YoLink Hub

Model/Type Ref.: YS1603-UC

Tested Date: 2022-12-02 to 2022-12-27

Issued Date: 2022-12-27

Shenzhen BCTC Testing Co., Ltd.



SHENZHEN

FCC ID:2ATM71603M

Product Name: YoLink Hub
Trademark: N/A
Model/Type Ref.: YS1603-UC
YS1603-UA
Prepared For: YoSmart Inc.
Address: 15375 Barranca Parkway, Ste G-105 Irvine, CA 92618, USA
Manufacturer: YoSmart Inc.
Address: 15375 Barranca Parkway, Ste G-105 Irvine, CA 92618, USA
Prepared By: Shenzhen BCTC Testing Co., Ltd.
Address: 1-2/F., Building B, Pengzhou Industrial Park, No.158, Fuyuan 1st Road,
Zhancheng, Fuhai Subdistrict, Bao'an District, Shenzhen, Guangdong, China
Sample Received Date: 2022-12-02
Sample tested Date: 2022-12-02 to 2022-12-27
Issue Date: 2022-12-27
Report No.: BCTC2212747219-2E
Test Standards: FCC Part15.249
ANSI C63.10-2013
Test Results: PASS

Tested by:



Jeff.Fu/Project Handler

Approved by:



Zero Zhou/Reviewer

The test report is effective only with both signature and specialized stamp. This result(s) shown in this report refer only to the sample(s) tested. Without written approval of Shenzhen BCTC Testing Co., Ltd, this report can't be reproduced except in full. The tested sample(s) and the sample information are provided by the client.



Table Of Content

	Page
Test Report Declaration	
1. Version	4
2. Test Summary	5
3. Measurement Uncertainty	6
4. Product Information And Test Setup	7
4.1 Product Information.....	7
4.2 Test Setup Configuration	7
4.3 Support Equipment	8
4.5 Test Mode	8
5. Test Facility And Test Instrument Used.....	9
5.1 Test Facility.....	9
5.2 Test Instrument Used.....	9
6. Conducted Emissions.....	11
6.1 Block Diagram Of Test Setup.....	11
6.2 Limit	11
6.3 Test Procedure	11
6.4 EUT Operating Conditions	11
6.5 Test Result.....	12
7. Radiated Emissions.....	14
7.1 Block Diagram Of Test Setup.....	14
7.2 Limit	15
7.3 Test Procedure	16
7.4 EUT Operating Conditions	17
7.5 Test Result.....	18
7.6 Field Strength Calculation	22
8. Band Edge Emission	23
8.1 Block Diagram Of Test Setup.....	23
8.2 Applicable Standard	23
8.3 Test Procedure	23
8.4 EUT Operating Conditions	23
8.5 Test Result.....	24
9. 20 DB Bandwidth.....	26
9.1 Block Diagram Of Test Setup.....	26
9.2 Limit	26
9.3 Test Procedure	26
9.4 EUT Operation Conditions	26
9.5 Test Result.....	27
10. Antenna Requirement	28
10.1 Limit	28
10.2 Test Result.....	28
11. EUT Photographs.....	29
12. EUT Test Setup Photographs.....	30

(Note: N/A Means Not Applicable)

 BCTC
 3C
 PPR
 检测

1. Version

Report No.	Issue Date	Description	Approved
BCTC2212747219-2E	2022-12-27	Original	Valid

TEC
TC
OVB
檢

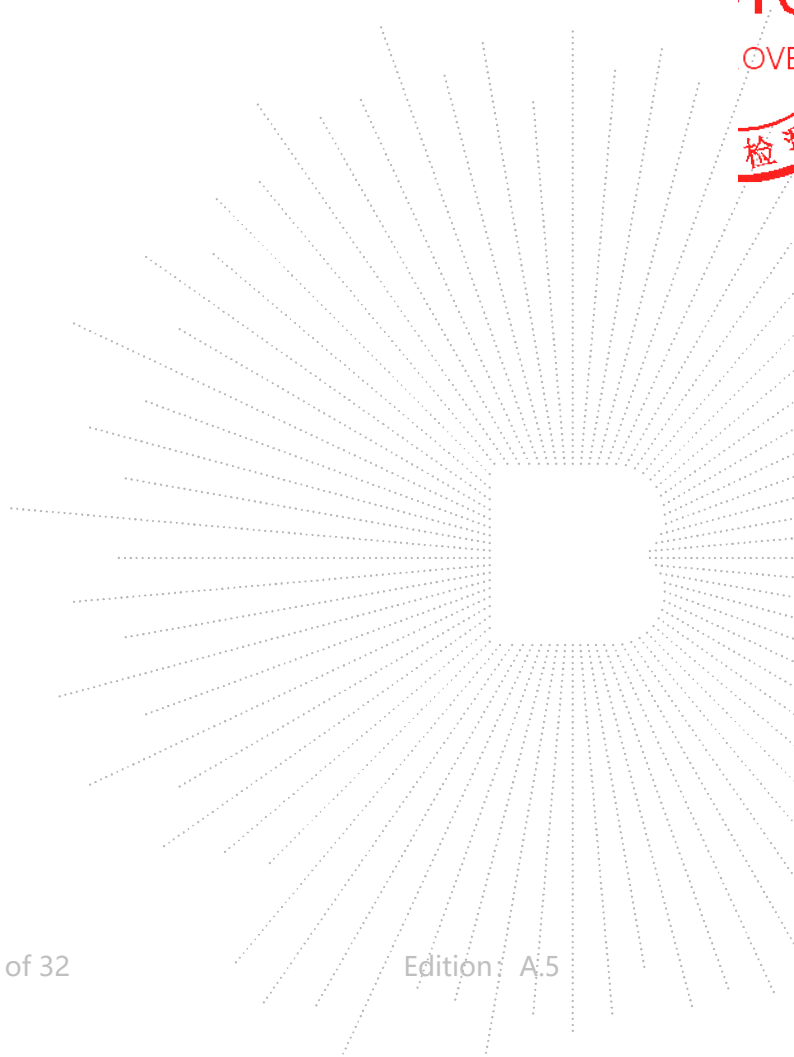

2. Test Summary

The Product has been tested according to the following specifications:

No.	Test Parameter	Clause No	Results
1	Conducted Emission	15.207	N/A
2	20dB Bandwidth	15.215	PASS
3	Fundamental & Radiated Spurious Emission Measurement	15.249	PASS
4	Band Edge Emission	15.205	PASS
5	Antenna Requirement	15.203	PASS

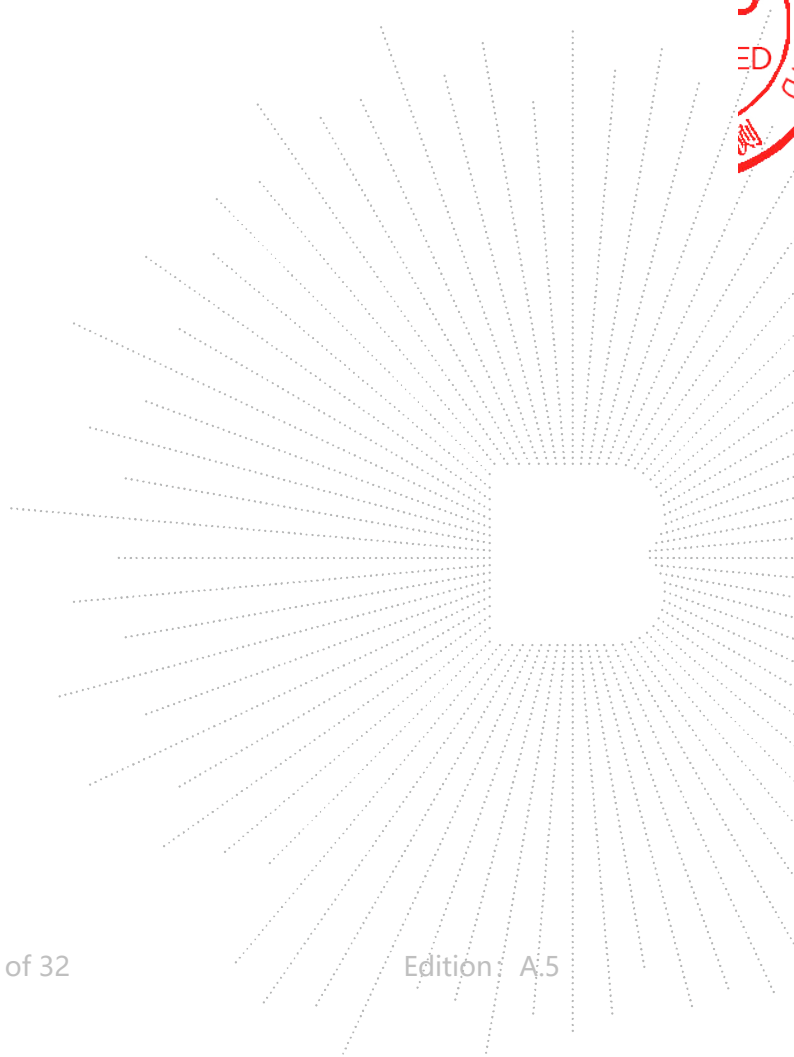

3. Measurement Uncertainty

Where relevant, the following measurement uncertainty levels have been estimated for tests performed on the Product as specified in CISPR 16-4-2. This uncertainty represents an expanded uncertainty expressed at approximately the 95% confidence level using a coverage factor of k=2.

No.	Item	Uncertainty
1	3m chamber Radiated spurious emission(9kHz-30MHz)	U=3.7dB
2	3m chamber Radiated spurious emission(30MHz-1GHz)	U=4.3dB
3	3m chamber Radiated spurious emission(1GHz-18GHz)	U=4.5dB
4	3m chamber Radiated spurious emission(18GHz-40GHz)	U=3.34dB
5	Conducted Emission(150kHz-30MHz)	U=3.20dB
6	Conducted Adjacent channel power	U=1.38dB
7	Conducted output power uncertainty Above 1G	U=1.576dB
8	Conducted output power uncertainty below 1G	U=1.28dB
9	humidity uncertainty	U=5.3%
10	Temperature uncertainty	U=0.59°C

 CO. LTD

4. Product Information And Test Setup

4.1 Product Information

Model/Type Ref.:	YS1603-UC YS1603-UA
Model differences:	All the model are the same circuit and RF module, except model names.
Operation Frequency:	923.3MHz
Type of Modulation:	LoRa
Number Of Channel	1CH
Antenna installation:	Internal antenna
Antenna Gain:	-0.46 dBi
Ratings:	DC 5V From adapter
Adapter:	Manufacture: ShenZhen LvXiangYuan Technology Co., Ltd. Model No.: LX050100 Input: 100-240V~ 50/60Hz 0.35A Output: DC 5V 1A

4.2 Test Setup Configuration

See test photographs attached in *EUT TEST SETUP PHOTOGRAPHS* for the actual connections between Product and support equipment.

Conducted Emission:

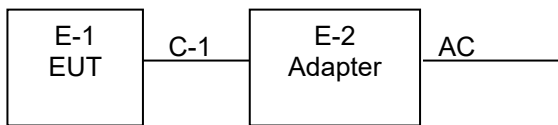

Radiated Spurious Emission

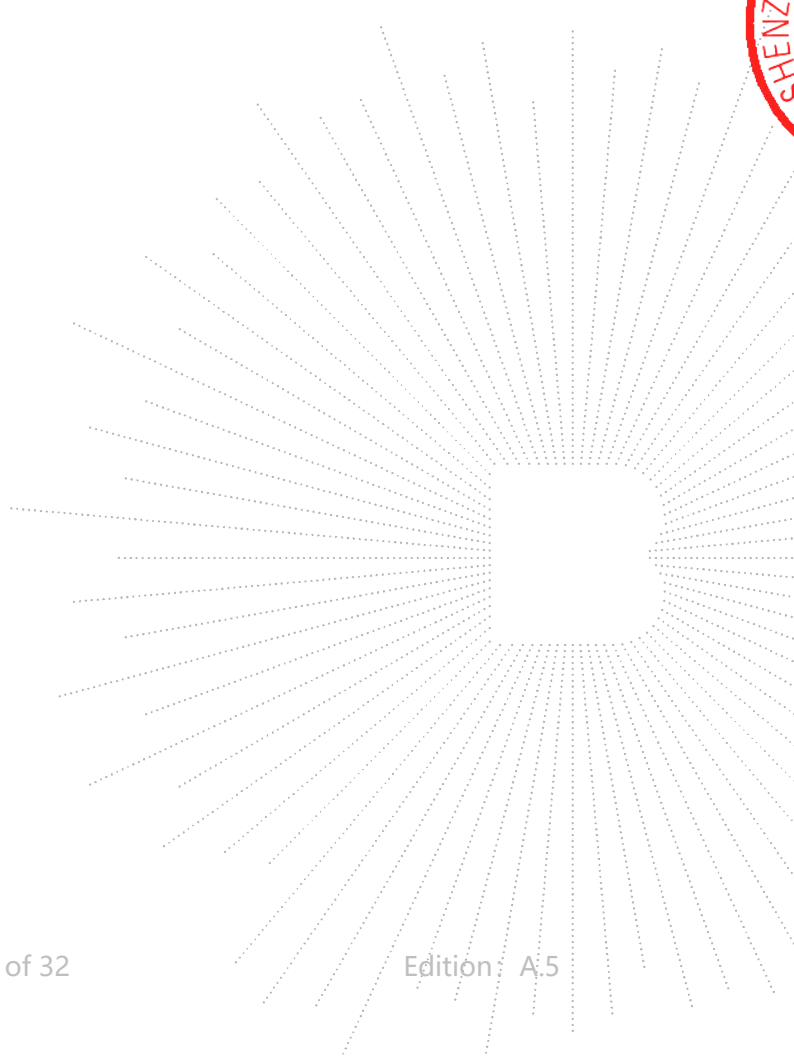
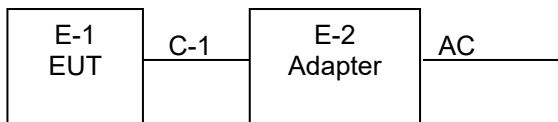

4.3 Support Equipment

No.	Device Type	Brand	Model	Series No.	Note
E-1	YoLink Hub	N/A	YS1603-UC	N/A	EUT
E-2	Adapter	N/A	LX050100	N/A	EUT

Item	Shielded Type	Ferrite Core	Length	Note
C-1	NO	NO	0.5M	DC cable unshielded

Notes:

1. All the equipment/cables were placed in the worst-case configuration to maximize the emission during the test.
2. Grounding was established in accordance with the manufacturer's requirements and conditions for the intended use.

4.4 Channel List

CH	Frequency (MHz)
1	923.3

4.5 Test Mode

To investigate the maximum EMI emission characteristics generates from EUT, the test system was pre-scanning tested base on the consideration of following EUT operation mode or test configuration mode which possible have effect on EMI emission level. Each of these EUT operation mode(s) or test configuration mode(s) mentioned above was evaluated respectively.

Test Mode	Test mode
1	Transmitting

Note:

- (1) The measurements are performed at the highest, middle, lowest available channels.

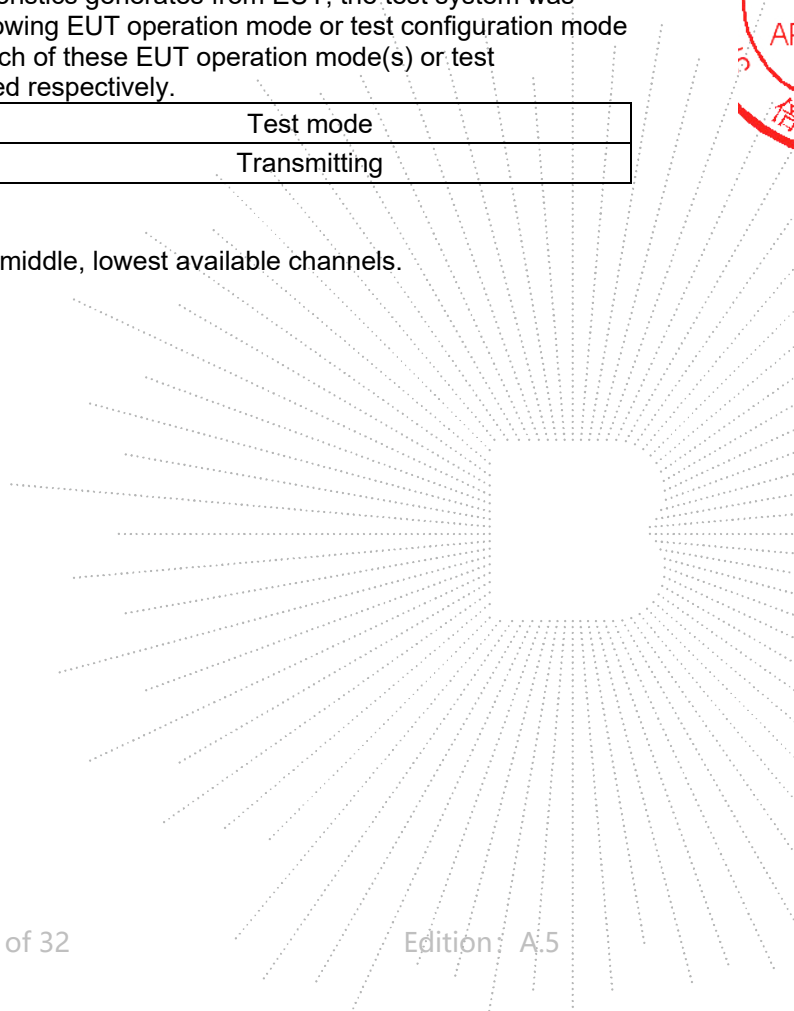

5. Test Facility And Test Instrument Used

5.1 Test Facility

All measurement facilities used to collect the measurement data are located at Shenzhen BCTC Testing Co., Ltd. Address: 1-2/F., Building B, Pengzhou Industrial Park, No.158, Fuyuan 1st Road, Zhancheng, Fuhai Subdistrict, Bao'an District, Shenzhen, Guangdong, China. The site and apparatus are constructed in conformance with the requirements of ANSI C63.4 and CISPR 16-1-1 other equivalent standards.
 FCC Test Firm Registration Number: 712850
 IC Registered No.: 23583

5.2 Test Instrument Used

Conducted emissions Test					
Equipment	Manufacturer	Model#	Serial#	Last Cal.	Next Cal.
Receiver	R&S	ESR3	102075	May 24, 2022	May 23, 2023
LISN	R&S	ENV216	101375	May 24, 2022	May 23, 2023
Software	Frad	EZ-EMC	EMC-CON 3A1	\	\
Attenuator	\	10dB DC-6GHz	1650	May 24, 2022	May 23, 2023

RF Conducted Test					
Equipment	Manufacturer	Model#	Serial#	Last Cal.	Next Cal.
Power Metter	Keysight	E4419	\	May 24, 2022	May 23, 2023
Power Sensor (AV)	Keysight	E9300A	\	May 24, 2022	May 23, 2023
Signal Analyzer20kHz-26.5GHz	Keysight	N9020A	MY49100060	May 24, 2022	May 23, 2023
Spectrum Analyzer9kHz-40GHz	R&S	FSP40	100363	May 24, 2022	May 23, 2023

BCTC
 3C
 PPR
 检测

Radiated Emissions Test (966 Chamber01)					
Equipment	Manufacturer	Model#	Serial#	Last Cal.	Next Cal.
966 chamber	ChengYu	966 Room	966	Jun. 06. 2020	Jun. 05, 2023
Receiver	R&S	ESR3	102075	May 24, 2022	May 23, 2023
Receiver	R&S	ESRP	101154	May 24, 2022	May 23, 2023
Amplifier	Schwarzbeck	BBV9744	9744-0037	May 24, 2022	May 23, 2023
TRILOG Broadband Antenna	Schwarzbeck	VULB9163	942	May 26, 2022	May 25, 2023
Loop Antenna(9KHz -30MHz)	Schwarzbeck	FMZB1519B	00014	May 26, 2022	May 25, 2023
Amplifier	SKET	LAPA_01G18 G-45dB	\	May 24, 2022	May 23, 2023
Horn Antenna	Schwarzbeck	BBHA9120D	1541	Jun. 06, 2022	Jun. 05, 2023
Amplifier(18G Hz-40GHz)	MITEQ	TTA1840-35- HG	2034381	May 26, 2022	May 25, 2023
Horn Antenna(18G Hz-40GHz)	Schwarzbeck	BBHA9170	00822	Jun. 06, 2022	Jun. 05, 2023
Spectrum Analyzer9kHz- 40GHz	R&S	FSP40	100363	May 24, 2022	May 23, 2023
Software	Frad	EZ-EMC	FA-03A2 RE	\	\

TE
 TC
 OVE
 檢

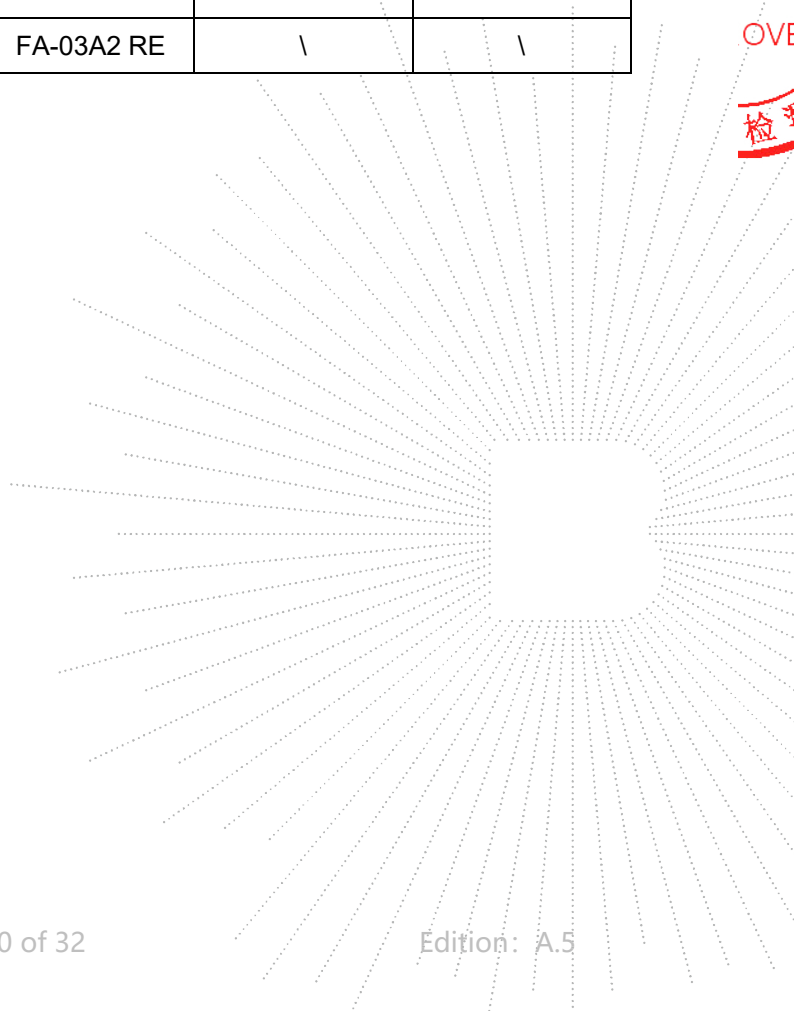

6. Conducted Emissions

6.1 Block Diagram Of Test Setup

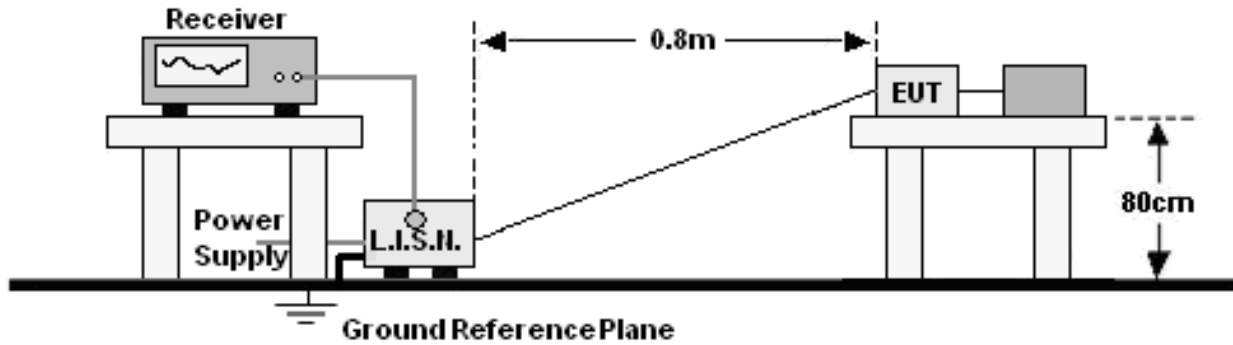

6.2 Limit

FREQUENCY (MHz)	Limit (dBuV)	
	Quas-peak	Average
0.15 -0.5	66 - 56 *	56 - 46 *
0.50 -5.0	56.00	46.00
5.0 -30.0	60.00	50.00

Notes:
 1. *Decreasing linearly with logarithm of frequency.
 2. The lower limit shall apply at the transition frequencies.

6.3 Test Procedure

Receiver Parameters	Setting
Attenuation	10 dB
Start Frequency	0.15 MHz
Stop Frequency	30 MHz
IF Bandwidth	9 kHz

- The Product was placed on a nonconductive table 0.8 m above the horizontal ground reference plane, and 0.4 m from the vertical ground reference plane, and connected to the main through Line Impedance Stability Network (L.I.S.N).
- The RBW of the receiver was set at 9 kHz in 150 kHz ~ 30MHz with Peak and AVG detector in Max Hold mode. Run the receiver's pre-scan to record the maximum disturbance generated from Product in all power lines in the full band.
- For each frequency whose maximum record was higher or close to limit, measure its QP and AVG values and record.

6.4 EUT Operating Conditions

The EUT was configured for testing in a typical fashion (as a customer would normally use it). The EUT has been programmed to continuously transmit during test. This operating condition was tested and used to collect the included data.

6.5 Test Result

Temperature:	26 °C	Relative Humidity:	54%
Pressure:	101kPa	Phase :	Line
Test Voltage :	AC 120V/60Hz	Test Mode:	Mode 1

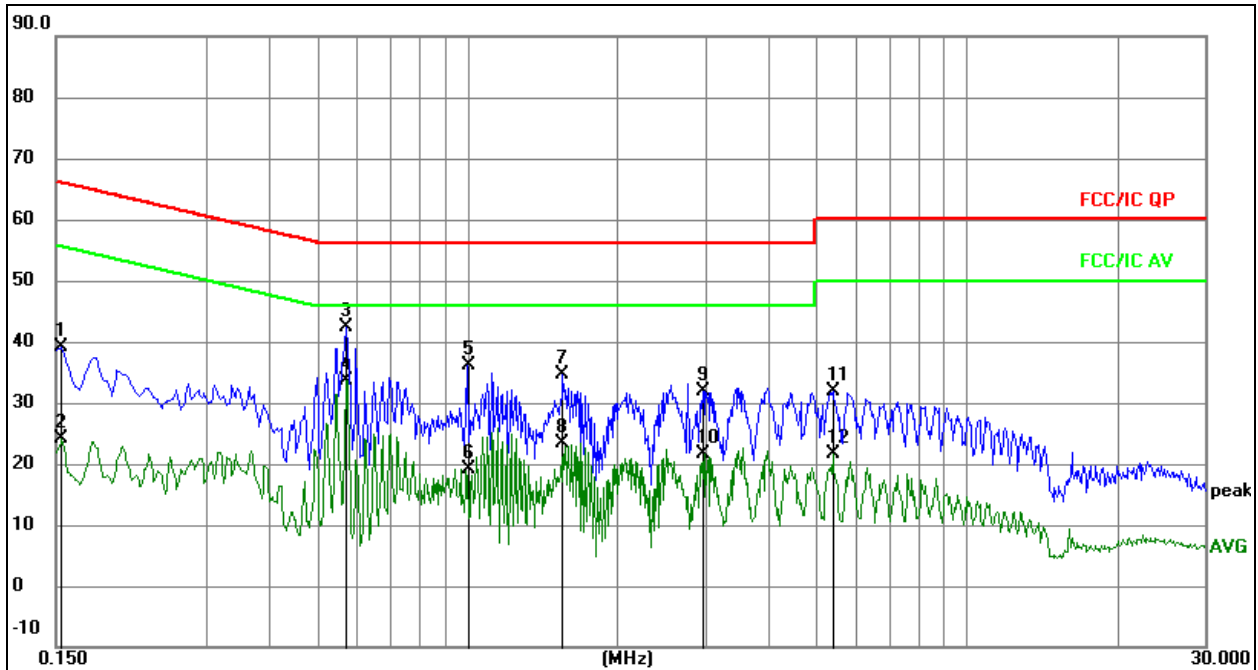

Remark:

1. All readings are Quasi-Peak and Average values.
2. Factor = Insertion Loss + Cable Loss.
3. Measurement=Reading Level+ Correct Factor
4. Over= Measurement-Limit

No.	Mk.	Freq. MHz	Reading Level	Correct Factor dB	Measure- ment dBuV	Limit dBuV	Over dB	Detector
1		0.1539	19.40	19.68	39.08	65.79	-26.71	QP
2		0.1539	4.49	19.68	24.17	55.79	-31.62	AVG
3		0.5701	22.58	19.73	42.31	56.00	-13.69	QP
4	*	0.5701	13.96	19.73	33.69	46.00	-12.31	AVG
5		0.9997	16.46	19.76	36.22	56.00	-19.78	QP
6		0.9997	-0.56	19.76	19.20	46.00	-26.80	AVG
7		1.5518	14.75	19.83	34.58	56.00	-21.42	QP
8		1.5518	3.45	19.83	23.28	46.00	-22.72	AVG
9		2.9619	11.90	19.99	31.89	56.00	-24.11	QP
10		2.9619	1.71	19.99	21.70	46.00	-24.30	AVG
11		5.3900	11.68	20.14	31.82	60.00	-28.18	QP
12		5.3900	1.38	20.14	21.52	50.00	-28.48	AVG

Temperature:	26 °C	Relative Humidity:	54%
Pressure:	101kPa	Phase :	Neutral
Test Voltage :	AC 120V/60Hz	Test Mode:	Mode 1

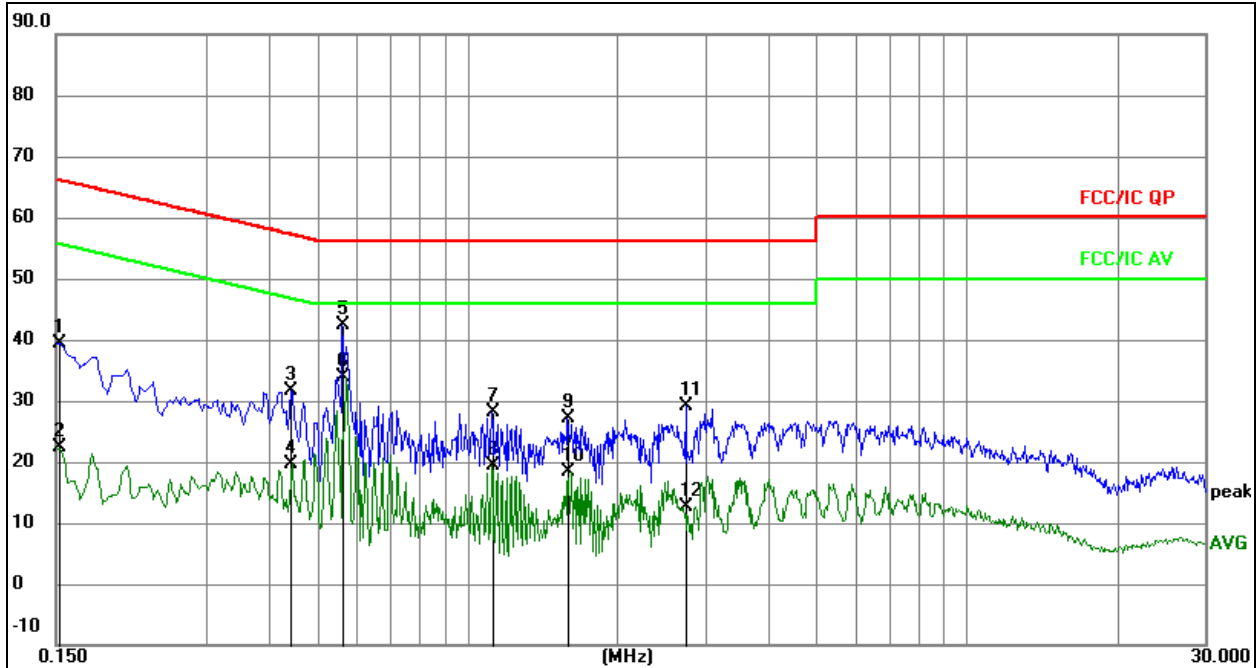
Remark:

1. All readings are Quasi-Peak and Average values.
2. Factor = Insertion Loss + Cable Loss.
3. Measurement=Reading Level+ Correct Factor
4. Over= Measurement-Limit

No.	Mk.	Freq. MHz	Reading Level	Correct Factor dB	Measure- ment dBuV	Limit dBuV	Over dB	Detector
1		0.1516	19.76	19.67	39.43	65.91	-26.48	QP
2		0.1516	2.75	19.67	22.42	55.91	-33.49	AVG
3		0.4425	12.01	19.74	31.75	57.01	-25.26	QP
4		0.4425	-0.13	19.74	19.61	47.01	-27.40	AVG
5		0.5639	22.60	19.73	42.33	56.00	-13.67	QP
6	*	0.5639	14.04	19.73	33.77	46.00	-12.23	AVG
7		1.1220	8.43	19.77	28.20	56.00	-27.80	QP
8		1.1220	-0.43	19.77	19.34	46.00	-26.66	AVG
9		1.5900	7.24	19.83	27.07	56.00	-28.93	QP
10		1.5900	-1.39	19.83	18.44	46.00	-27.56	AVG
11		2.7420	9.14	19.96	29.10	56.00	-26.90	QP
12		2.7420	-7.28	19.96	12.68	46.00	-33.32	AVG

SHENZHEN

7. Radiated Emissions

7.1 Block Diagram Of Test Setup

(A) Radiated Emission Test-Up Frequency Below 30MHz

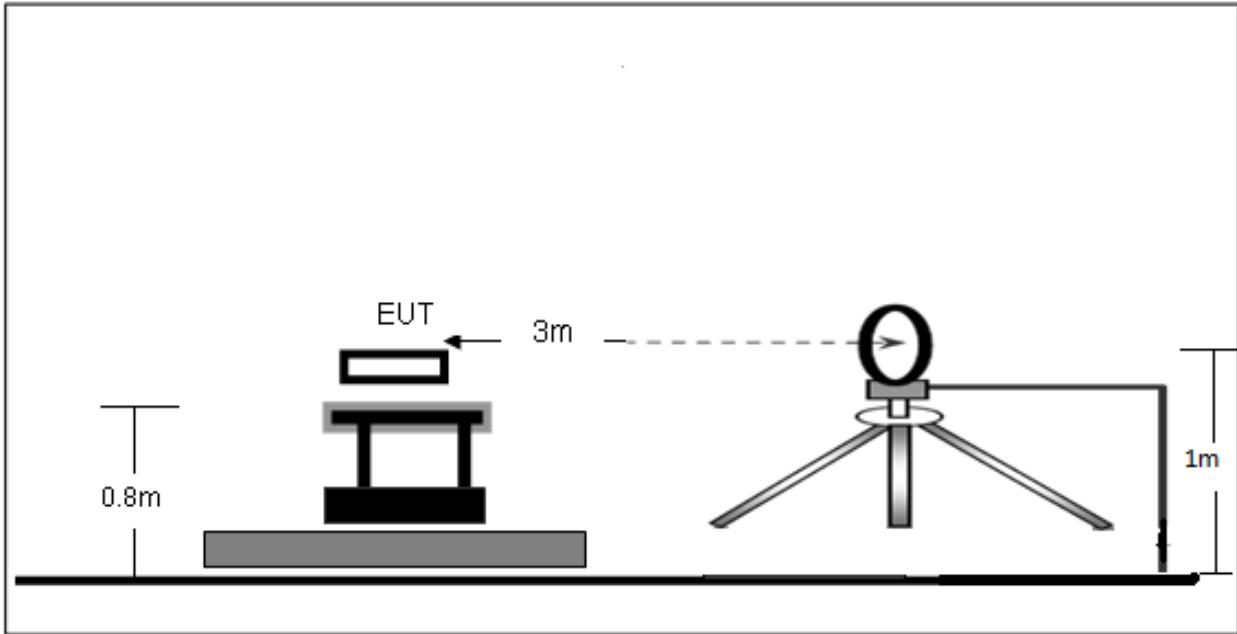

(B) Radiated Emission Test-Up Frequency 30MHz~1GHz

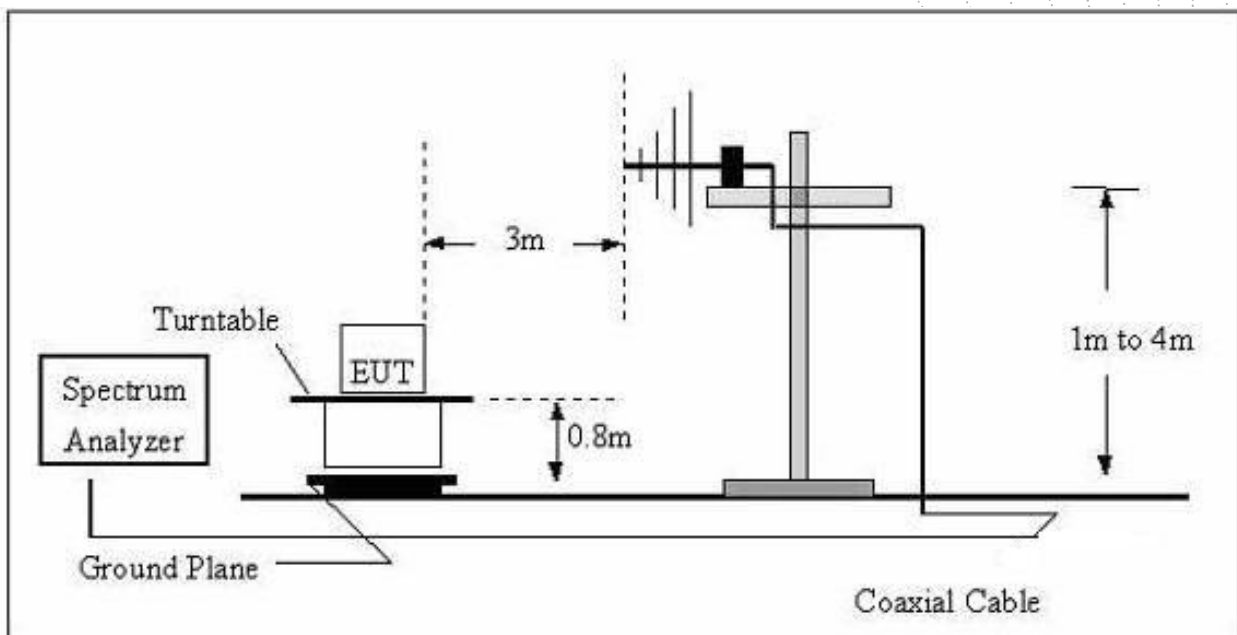

(C) Radiated Emission Test-Up Frequency Above 1GHz

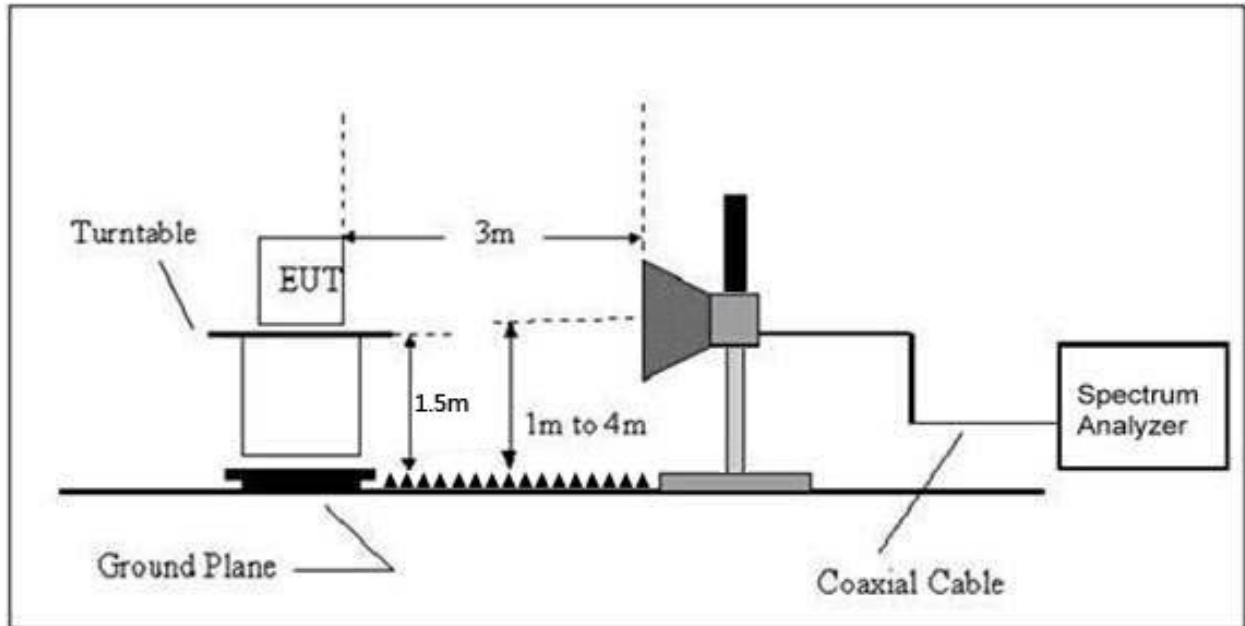

7.2 Limit

20dBc in any 100 kHz bandwidth outside the operating frequency band. In case the emission fall within the restricted band specified on 15.205(a), then the 15.209(a) limit in the table below has to be followed.

Frequency (MHz)	Field Strength uV/m	Distance (m)	Field Strength Limit at 3m Distance	
			uV/m	dBuV/m
0.009 ~ 0.490	$2400/F(\text{kHz})$	300	$10000 * 2400/F(\text{kHz})$	$20\log^{(2400/F(\text{kHz}))} + 80$
0.490 ~ 1.705	$24000/F(\text{kHz})$	30	$100 * 24000/F(\text{kHz})$	$20\log^{(24000/F(\text{kHz}))} + 40$
1.705 ~ 30	30	30	$100 * 30$	$20\log^{(30)} + 40$
30 ~ 88	100	3	100	$20\log^{(100)}$
88 ~ 216	150	3	150	$20\log^{(150)}$
216 ~ 960	200	3	200	$20\log^{(200)}$
Above 960	500	3	500	$20\log^{(500)}$

The field strength of emissions from intentional radiators operated within these frequency bands shall comply with the following:

Fundamental frequency	Field strength of fundamental (millivolts/meter)	Field strength of harmonics (microvolts/meter)
902-928 MHz	50	500
2400-2483.5 MHz	50	500
5725-5875 MHz	50	500
24.0-24.25 GHz	250	2500

LIMITS OF RADIATED EMISSION MEASUREMENT (Above 1000MHz)

FREQUENCY (MHz)	Limit (dBuV/m) (at 3M)	
	PEAK	AVERAGE
Above 1000	74	54

Notes:

- (1)The limit for radiated test was performed according to FCC PART 15C.
- (2)The tighter limit applies at the band edges.
- (3) Emission level (dBuV/m)=20log Emission level (uV/m).

FREQUENCY RANGE OF RADIATED MEASUREMENT (For unintentional radiators)

Highest frequency generated or Upper frequency of measurement used in the device or on which the device operates or tunes (MHz)	Range (MHz)
Below 1.705	30
1.705 – 108	1000
108 – 500	2000
500 – 1000	5000
Above 1000	5 th harmonic of the highest frequency or 40 GHz, whichever is lower

7.3 Test Procedure

Spectrum Parameter	Setting
Attenuation	Auto
Start Frequency	1000 MHz
Stop Frequency	10th carrier harmonic
RB / VB (emission in restricted band)	1 MHz / 1 MHz for Peak, 1 MHz / 10Hz for Average

Receiver Parameter	Setting
Attenuation	Auto
Start ~ Stop Frequency	9kHz~150kHz / RB 200Hz for QP
Start ~ Stop Frequency	150kHz~30MHz / RB 9kHz for QP
Start ~ Stop Frequency	30MHz~1000MHz / RB 120kHz for QP

TEST
 TO
 OVER
 検

Below 1GHz test procedure as below:

- a. The EUT was placed on the top of a rotating table 0.8 meters above the ground at a 3 meter semi-anechoic chamber. The table was rotated 360 degrees to determine the position of the highest radiation.
- b. The EUT was set 3 meters away from the interference-receiving antenna, which was mounted on the top of a variable-height antenna tower.
- c. The antenna height is varied from one meter to four meters above the ground to determine the maximum value of the field strength. Both horizontal and vertical polarizations of the antenna are set to make the measurement.
- d. For each suspected emission, the EUT was arranged to its worst case and then the antenna was tuned to heights from 1 meter to 4 meters (for the test frequency of below 30MHz, the antenna was tuned to heights 1 meter) and the rotatable table was turned from 0 degrees to 360 degrees to find the maximum reading.
- e. The test-receiver system was set to Peak Detect Function and Specified Bandwidth with Maximum Hold Mode.
- f. If the emission level of the EUT in peak mode was 10dB lower than the limit specified, then testing could be stopped and the peak values of the EUT would be reported. Otherwise the emissions that did not have 10dB margin would be re-tested one by one using peak, quasi-peak or average method as specified and then reported in a data sheet.

Above 1GHz test procedure as below:

- g. Different between above is the test site, change from Semi- Anechoic Chamber to fully Anechoic Chamber and change form table 0.8 metre to 1.5 metre(Above 18GHz the distance is 1 meter and table is 1.5 metre).
- h. Test the EUT in the lowest channel ,the middle channel ,the Highest channel.

Note:

Both horizontal and vertical antenna polarities were tested and performed pretest to three orthogonal axis. The worst case emissions were reported.

Above 1GHz test procedure as below:

- a. The EUT was placed on the top of a rotating table 1.5 meters above the ground at a 3 meter chamber. The table was rotated 360 degrees to determine the position of the highest radiation.
- b. The EUT was set 3 meters away from the interference-receiving antenna, which was mounted on the top of a variable-height antenna tower.
- c. The antenna height is varied from one meter to four meters above the ground to determine the maximum value of the field strength. Both horizontal and vertical polarizations of the antenna are set to make the measurement.
- d. For each suspected emission, the EUT was arranged to its worst case and then the antenna was tuned to heights from 1 meter to 4 meters and the rota table was turned from 0 degrees to 360 degrees to find the maximum reading.
- e. The test-receiver system was set to Peak Detect Function and Specified Bandwidth with Maximum Hold Mode.
- f. If the emission level of the EUT in peak mode was 10dB lower than the limit specified, then testing could be stopped and the peak values of the EUT would be reported. Otherwise the emissions that did not have 10dB margin would be re-tested one by one using peak, quasi-peak or average method as specified and then reported in a data sheet.
- g. Test the EUT in the lowest channel, the Highest channel.

Note:

Both horizontal and vertical antenna polarities were tested and performed pretest to three orthogonal axis. The worst case emissions were reported.

7.4 EUT Operating Conditions

The EUT was configured for testing in a typical fashion (as a customer would normally use it). The EUT has been programmed to continuously transmit during test. This operating condition was tested and used to collect the included data.



7.5 Test Result

Below 30MHz

Temperature:	26°C	Relative Humidity:	54%
Pressure:	101 kPa	Test Voltage :	AC 120V/60Hz
Test Mode :	Mode 1	Polarization :	--

Freq. (MHz)	Reading (dBuV/m)	Limit (dBuV/m)	Margin (dB)	State P/F
--	--	--	--	PASS
--	--	--	--	PASS

Note:

The amplitude of spurious emissions which are attenuated by more than 20dB below the permissible value has no need to be reported.

Distance extrapolation factor = $40 \log(\text{specific distance/test distance})(\text{dB})$;

Limit line = specific limits(dBuv) + distance extrapolation factor.

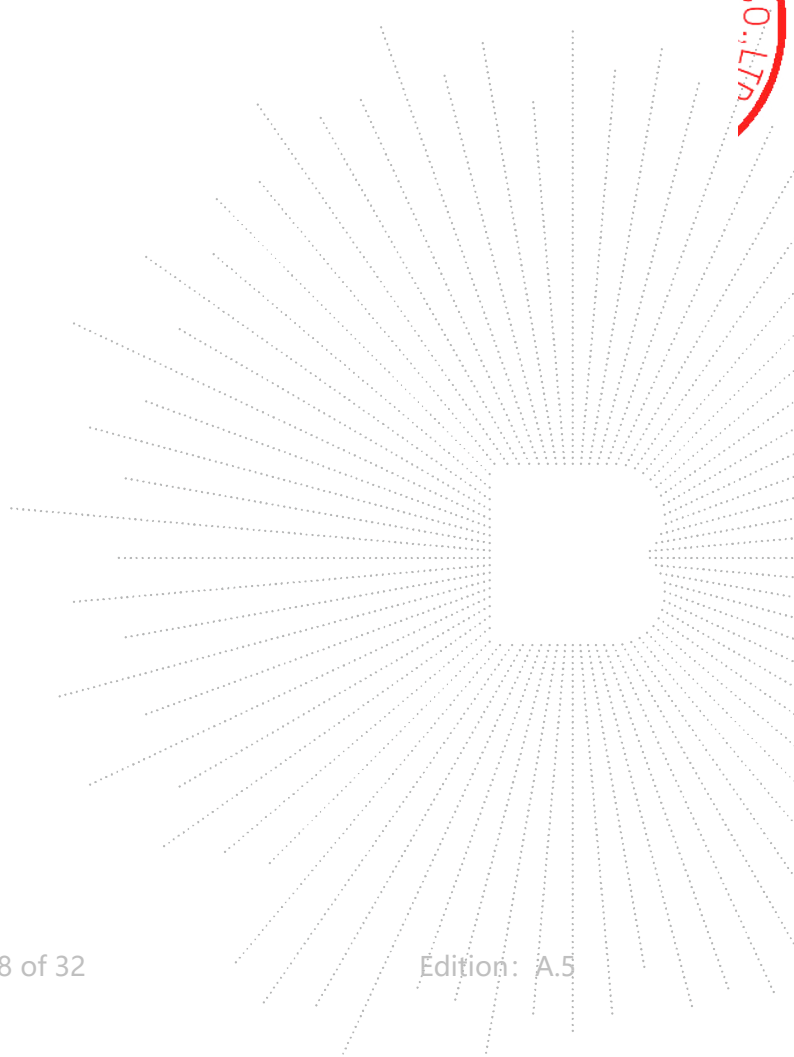
Between 30MHz – 1GHz

Temperature:	26°C	Relative Humidity:	54%
Pressure:	101 kPa	Test Voltage :	AC120V/60Hz
Test Mode :	Mode 1	Polarization :	Horizontal

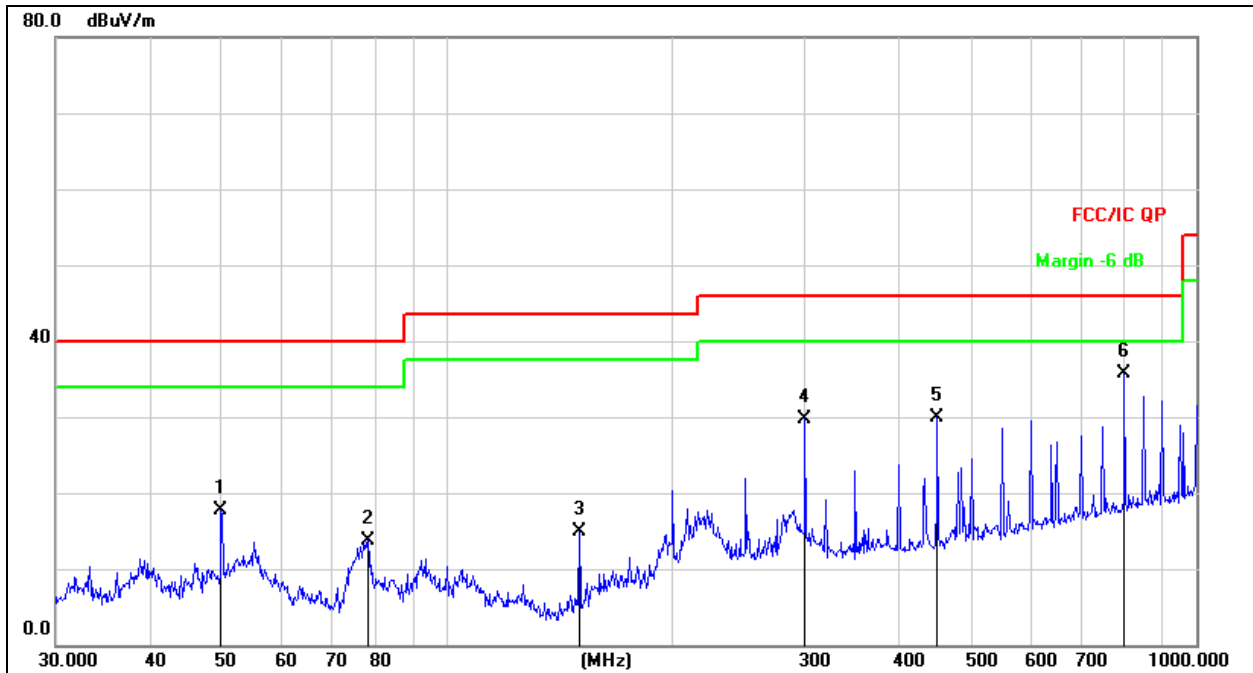

Remark:

1. Factor = Antenna Factor + Cable Loss – Pre-amplifier.
2. Measurement=Reading Level+ Correct Factor
3. Over= Measurement-Limit

No.	Mk.	Freq. MHz	Reading Level dBuV	Correct Factor dB	Measure- ment dBuV/m	Limit dB/m	Over dB	Detector
1		49.8813	33.35	-15.60	17.75	40.00	-22.25	QP
2		78.4133	34.99	-21.30	13.69	40.00	-26.31	QP
3		150.0107	36.05	-21.05	15.00	43.50	-28.50	QP
4		300.3672	44.20	-14.57	29.63	46.00	-16.37	QP
5		451.1349	41.27	-11.46	29.81	46.00	-16.19	QP
6	*	801.7862	41.34	-5.55	35.79	46.00	-10.21	QP

SHENZHEN

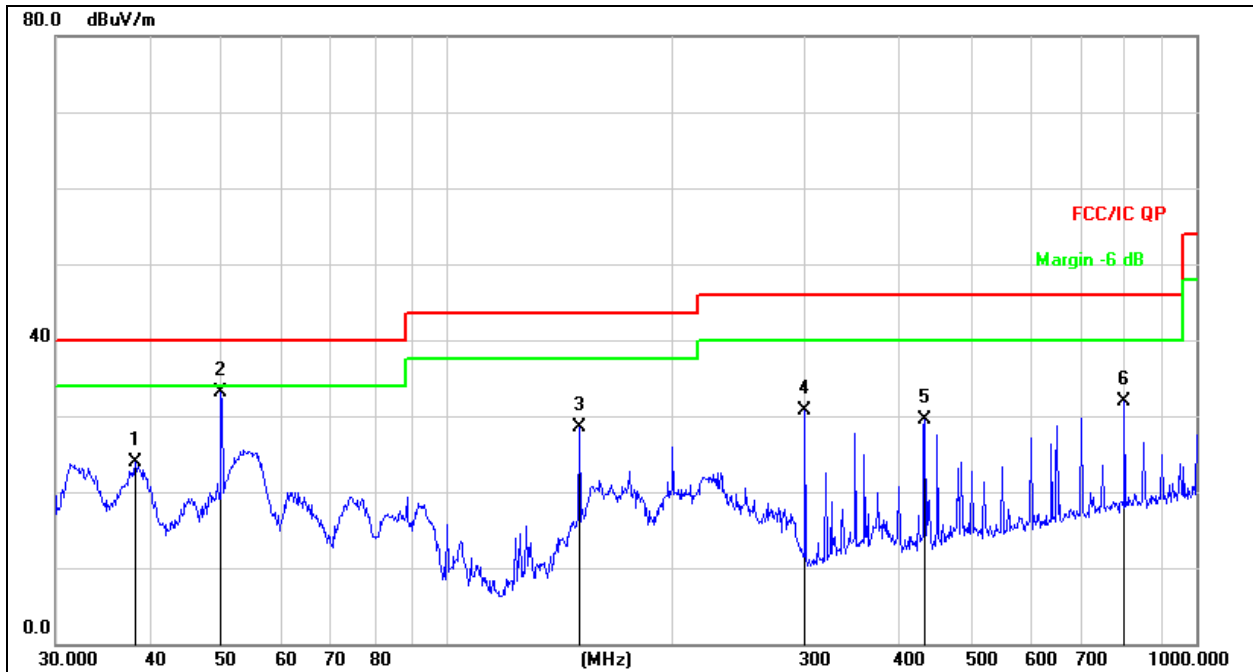
Temperature:	26°C	Relative Humidity:	54%
Pressure:	101 kpa	Test Voltage :	AC120V/60Hz
Test Mode :	Mode 1	Polarization :	Vertical



Remark:

1. Factor = Antenna Factor + Cable Loss – Pre-amplifier.
2. Measurement=Reading Level+ Correct Factor
3. Over= Measurement-Limit

No.	Mk.	Freq. MHz	Reading Level dBuV	Correct Factor dB	Measure- ment dBuV/m	Limit dB/m	Over dB	Detector
1		38.3462	40.87	-16.99	23.88	40.00	-16.12	QP
2	*	49.8814	48.63	-15.60	33.03	40.00	-6.97	QP
3		150.0108	49.48	-21.05	28.43	43.50	-15.07	QP
4		300.3672	45.32	-14.57	30.75	46.00	-15.25	QP
5		434.0651	41.18	-11.72	29.46	46.00	-16.54	QP
6		801.7863	37.55	-5.55	32.00	46.00	-14.00	QP



(Above 1000 MHz)
 Normal Voltage 923MHz

Polar (H/V)	Frequency (MHz)	Meter Reading (dBuV)	Factor (dB)	Emission Level (dBuV/m)	Limits (dBuV/m)	Margin (dB)	Detector Type
V	1846.60	53.34	-3.47	49.87	74.00	-24.13	PK
V	1846.60	42.88	-3.47	39.41	54.00	-14.59	AV
V	2769.90	43.08	-3.74	39.34	74.00	-34.66	PK
V	2769.90	33.96	-3.74	30.22	54.00	-23.78	AV
V	3693.20	44.17	-4.59	39.58	74.00	-34.42	PK
V	3693.20	35.21	-4.59	30.62	54.00	-23.38	AV
H	1846.60	49.38	-3.47	45.91	74.00	-28.09	PK
H	1846.60	39.90	-3.47	36.43	54.00	-17.57	AV
H	2769.90	40.83	-3.74	37.09	74.00	-36.91	PK
H	2769.90	32.18	-3.74	28.44	54.00	-25.56	AV
H	3693.20	48.36	-4.59	43.77	74.00	-30.23	PK
H	3693.20	36.12	-4.59	31.53	54.00	-22.47	AV

Remark:
 Absolute Level= ReadingLevel+ Factor, Margin= Limit- Absolute Level
 Other harmonics emissions are lower than 20dB below the allowable limit.

BCTC
 3C
 PPR
 检测

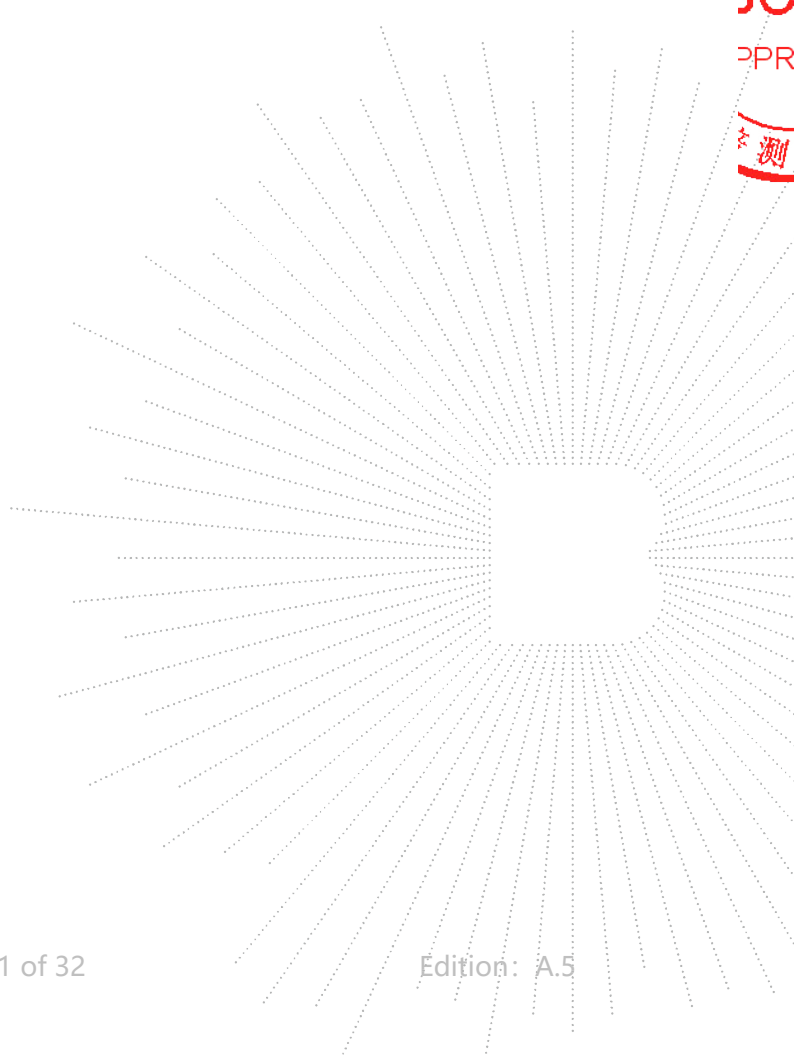

7.6 Field Strength Calculation

The field strength is calculated by adding the Antenna Factor and Cable Factor and subtracting the Amplifier Gain and Duty Cycle Correction Factor (if any) from the measured reading. The basic equation with a sample calculation is as follows:

$$FS=RA+AF+CL-AG$$

FS=Field Strength	CL=Cable Attenuation Factor (Cable Loss)
RA=Reading Amplitude	AG=Amplifier Gain
AF=Antenna Factor	

Test Result:

Temperature:	26°C	Relative Humidity:	54%
Pressure:	101kPa	Polarization :	Horizontal
Test Voltage :	AC120V/60Hz		
Test Mode :	Mode 1		

Frequency	Meter Reading	Factor	Emission Level	Limits	Margin	Detector Type
(MHz)	(dBμV)	(dB)	(dBμV/m)	(dBμV/m)	(dB)	
923.3	94.19	-1.40	92.79	114.00	-21.21	Peak
923.3	92.48	-1.40	91.08	94.00	-2.92	Average

Remark:
Factor = Antenna Factor + Cable Loss – Pre-amplifier.
All interfaces was connected, and TX mode

Temperature:	26°C	Relative Humidity:	54%
Pressure:	101kPa	Polarization :	Vertical
Test Voltage :	AC120V/60Hz		
Test Mode :	Mode 1		

Frequency	Meter Reading	Factor	Emission Level	Limits	Margin	Detector Type
(MHz)	(dBμV)	(dB)	(dBμV/m)	(dBμV/m)	(dB)	
923.3	87.43	-1.40	86.03	114.00	-27.97	Peak
923.3	46.30	-1.40	84.90	94.00	-9.10	Average

Remark:
Factor = Antenna Factor + Cable Loss – Pre-amplifier.
All interfaces was connected, and TX mode

8. Band Edge Emission

8.1 Block Diagram Of Test Setup

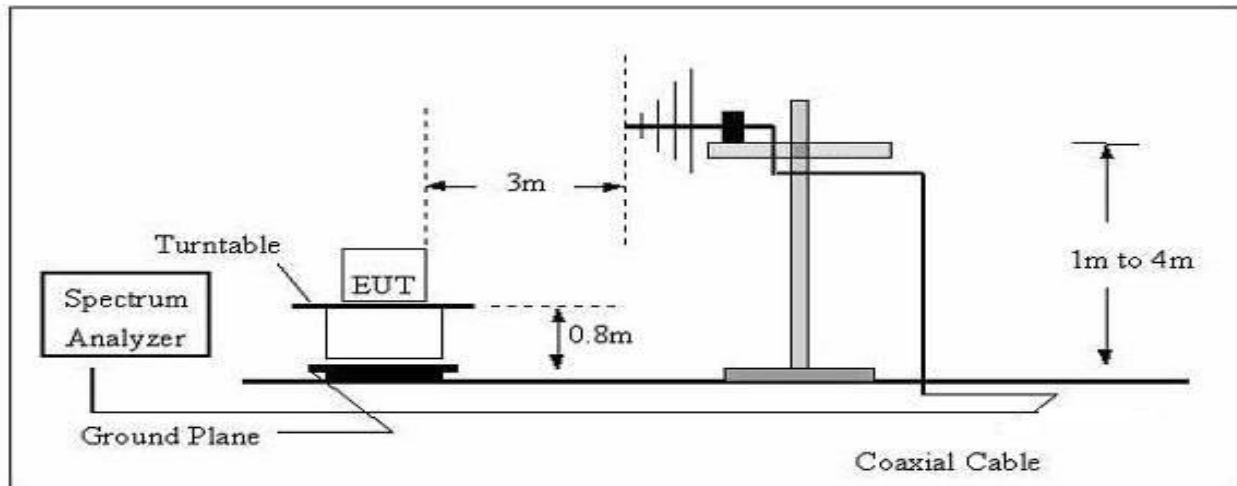

8.2 Applicable Standard

Emissions radiated outside of the specified frequency bands, except for harmonics, shall be

attenuated by at least 50 dB below the level of the fundamental or to the general radiated emission limits in § 15.209, whichever is the lesser attenuation

8.3 Test Procedure

- Check the calibration of the measuring instrument using either an internal calibrator or a known signal from an external generator.
- Position the EUT without connection to measurement instrument. Turn on the EUT and connect its antenna terminal to measurement instrument via a low loss cable. Then set it to any one measured frequency within its operating range, and make sure the instrument is operated in its linear range.
- VBW for Peak, Quasi-peak, or Average Detector Function: $3 \times \text{RBW}$
- Repeat above procedures until all measured frequencies were complete.

Note:

Both horizontal and vertical antenna polarities were tested and performed pretest to three orthogonal axis. The worst case emissions were reported.

8.4 EUT Operating Conditions

The EUT tested system was configured as the statements of 2.4 Unless otherwise a special operating condition is specified in the follows during the testing.

8.5 Test Result

Temperature:	26 °C	Relative Humidity:	54%
Pressure:	101 kPa	Test Voltage :	AC120V/60Hz
Test Mode :	Transmitting		

923MHz Horizontal

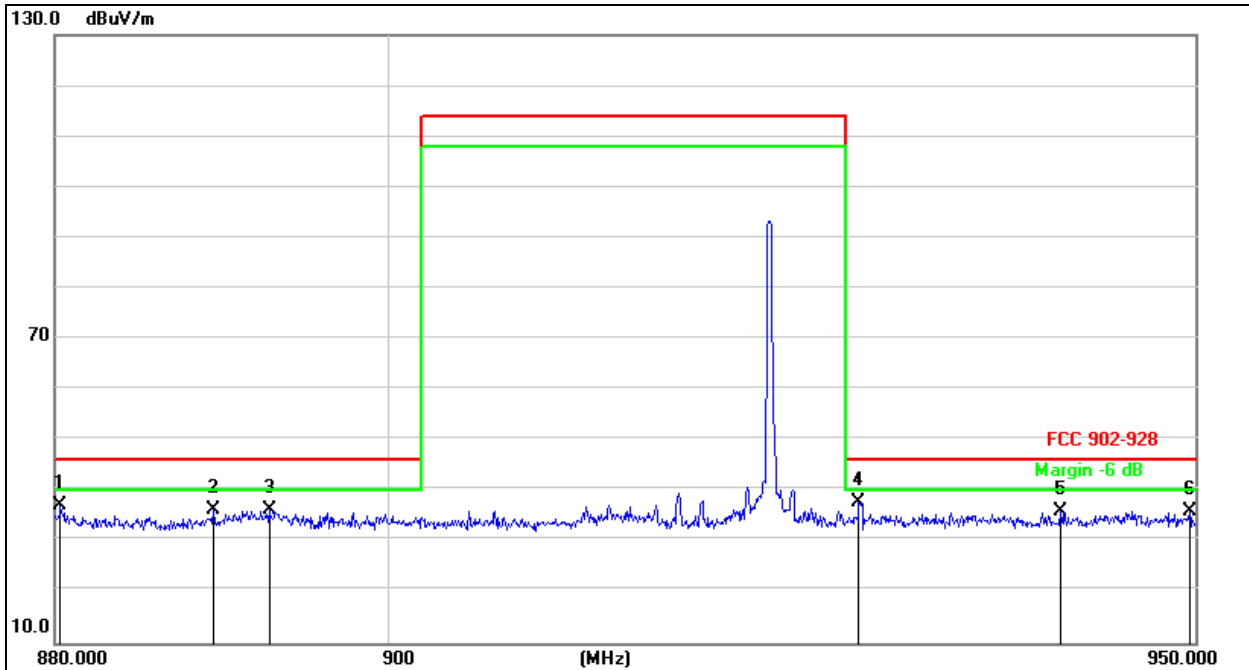

Remark:

1. Factor = Antenna Factor + Cable Loss – Pre-amplifier.
2. Measurement=Reading Level+ Correct Factor
3. Over= Measurement-Limit

No. Mk.	Freq. MHz	Reading Level dBuV	Correct Factor dB	Measure- ment dBuV/m	Limit dB/m	Over dB	Detector
1	880.3500	37.04	-0.03	37.01	46.00	-8.99	QP
2	889.4500	35.92	0.20	36.12	46.00	-9.88	QP
3	892.8097	36.10	0.28	36.38	46.00	-9.62	QP
4 *	928.8600	37.23	0.44	37.67	46.00	-8.33	QP
5	941.4600	35.47	0.44	35.91	46.00	-10.09	QP
6	949.6499	35.48	0.43	35.91	46.00	-10.09	QP

923MHz Vertical

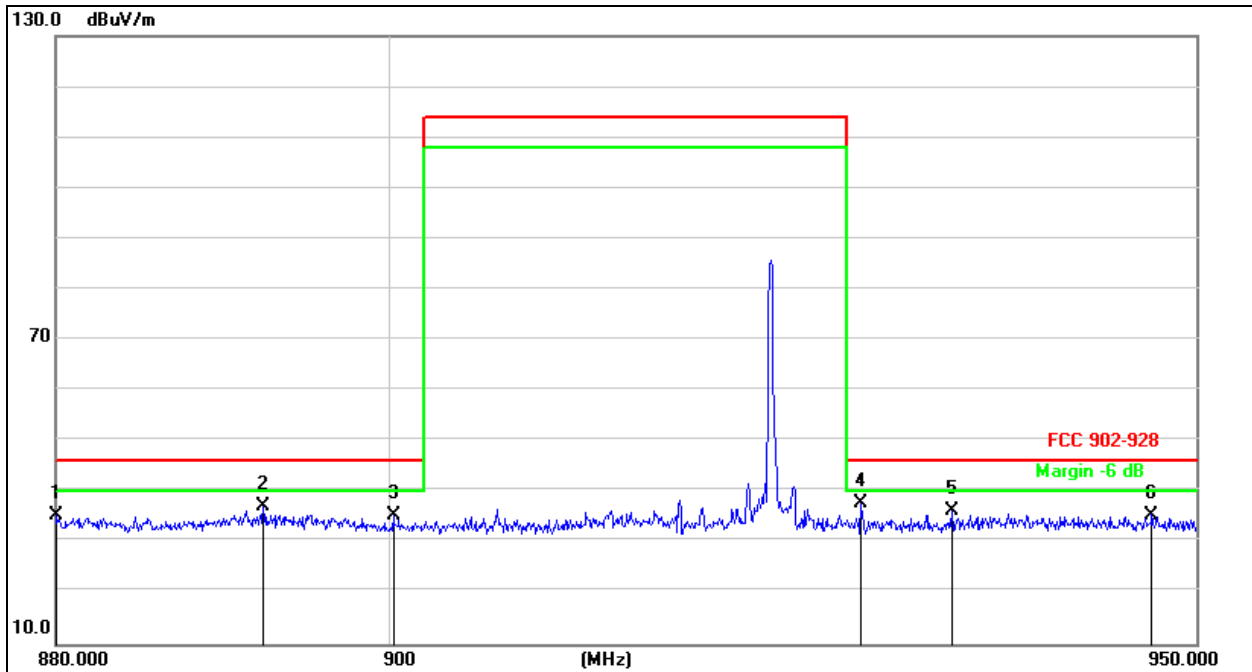

Remark:

1. Factor = Antenna Factor + Cable Loss – Pre-amplifier.
2. Measurement=Reading Level+ Correct Factor
3. Over= Measurement-Limit

No.	Mk.	Freq.	Reading Level	Correct Factor	Measurement	Limit	Over	Detector
		MHz	dBuV	dB	dBuV/m	dB/m	dB	
1		880.0700	35.31	-0.04	35.27	46.00	-10.73	QP
2		892.3899	36.74	0.27	37.01	46.00	-8.99	QP
3		900.2300	34.88	0.46	35.34	46.00	-10.66	QP
4	*	928.9298	37.26	0.44	37.70	46.00	-8.30	QP
5		934.6000	35.76	0.44	36.20	46.00	-9.80	QP
6		947.2000	35.07	0.43	35.50	46.00	-10.50	QP

9. 20 DB Bandwidth

9.1 Block Diagram Of Test Setup

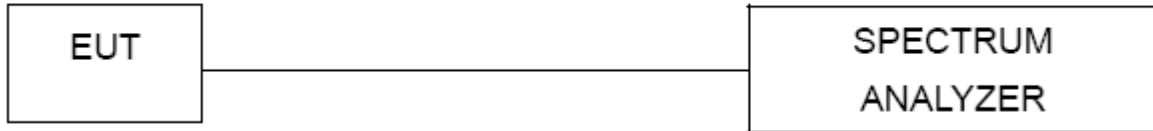

9.2 Limit

FCC Part15 (15.249) , Subpart C			
Section	Test Item	Frequency Range (MHz)	Result
15.249	Bandwidth	902~928	PASS

9.3 Test Procedure

1. Set resolution bandwidth (RBW) = 1-5% or DTS BW, not to exceed 100 kHz.
2. Set the video bandwidth (VBW) $\geq 3 \times$ RBW.
3. Detector = Peak.
4. Trace mode = max hold.
5. Sweep = auto couple.
6. Allow the trace to stabilize.
7. Measure the maximum width of the emission that is constrained by the frequencies associated with the two outermost amplitude points (upper and lower) that are attenuated by 20 dB relative to the maximum level measured in the fundamental emission.

9.4 EUT Operation Conditions

The EUT tested system was configured as the statements of 2.4 Unless otherwise a special operating condition is specified in the follows during the testing.

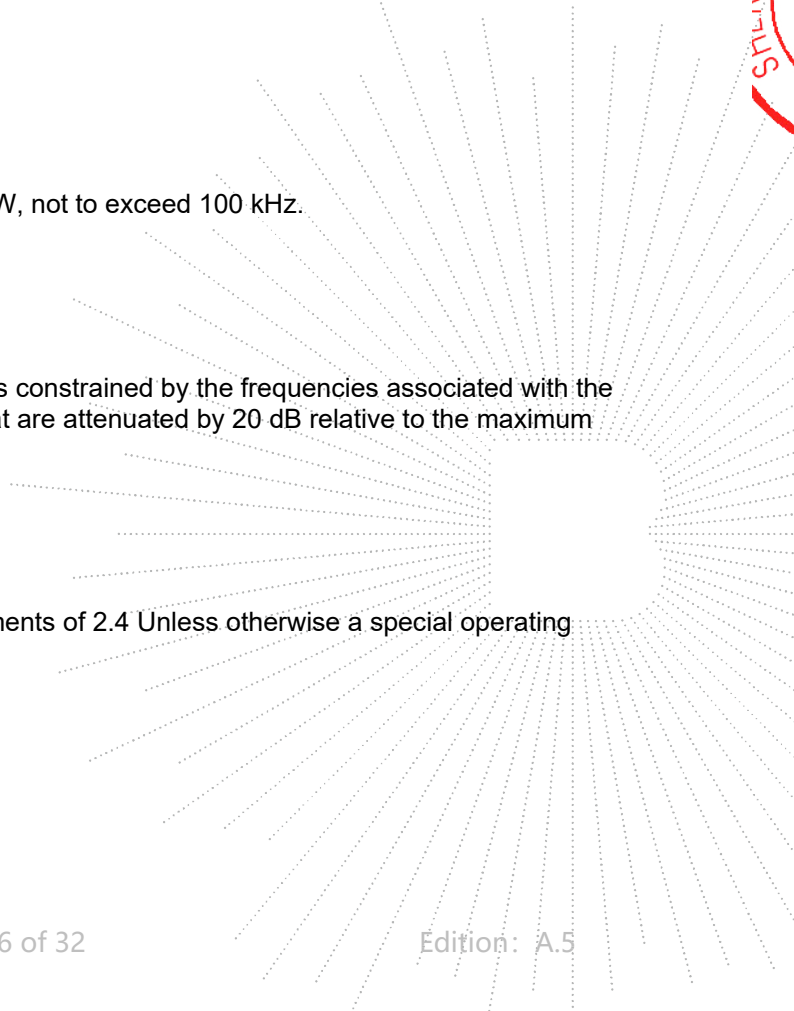

9.5 Test Result

Temperature :	26°C	Relative Humidity :	54%
Test Voltage :	AC120V/60Hz	Remark	N/A

Channel	Frequency (MHz)	20dB bandwidth (KHz)
01	923.3	137.8

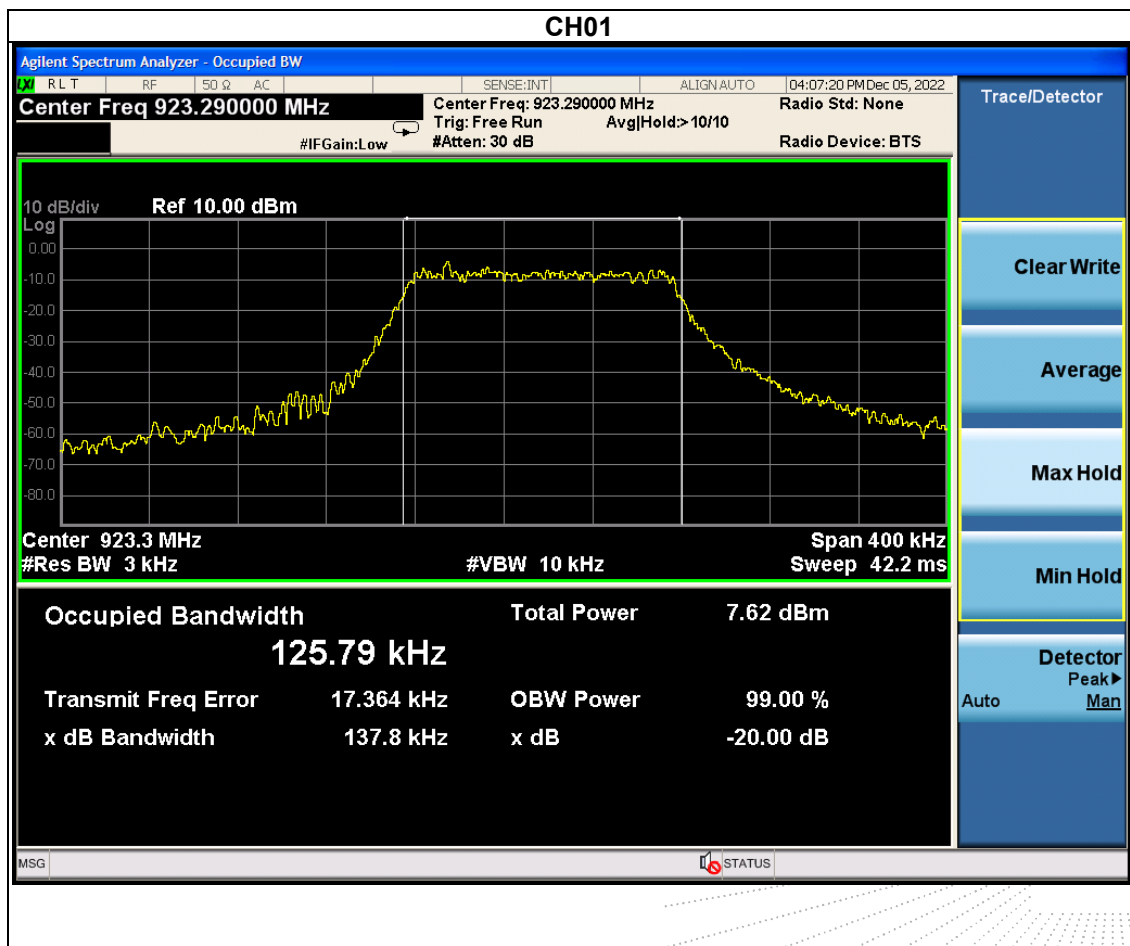

10. Antenna Requirement

10.1 Limit

15.203 requirement: For intentional device, according to 15.203: an intentional radiator shall be designed to ensure that no antenna other than that furnished by the responsible party shall be used with the device.

10.2 Test Result

The EUT antenna is Internal antenna, The antenna gain is -0.46dBi, fulfill the requirement of this section.

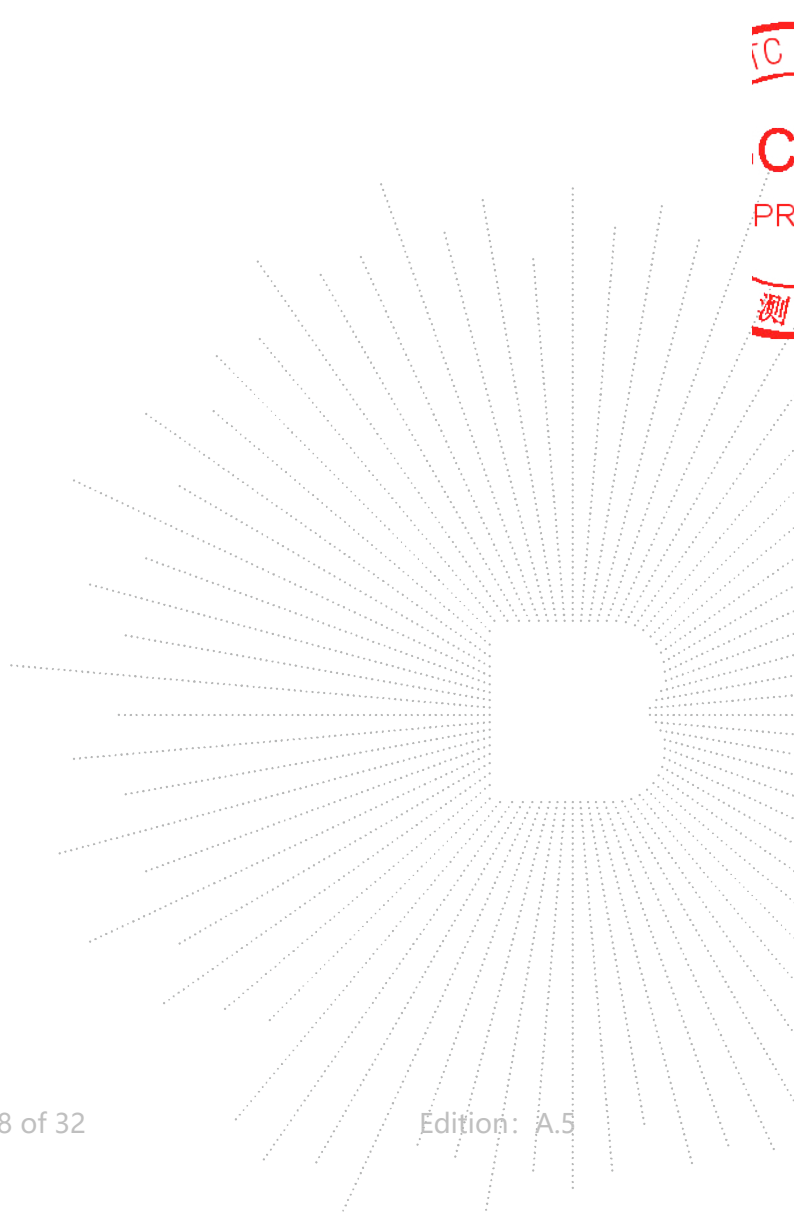

11. EUT Photographs

EUT Photo 1



EUT Photo 2



TE
T
OV
檢

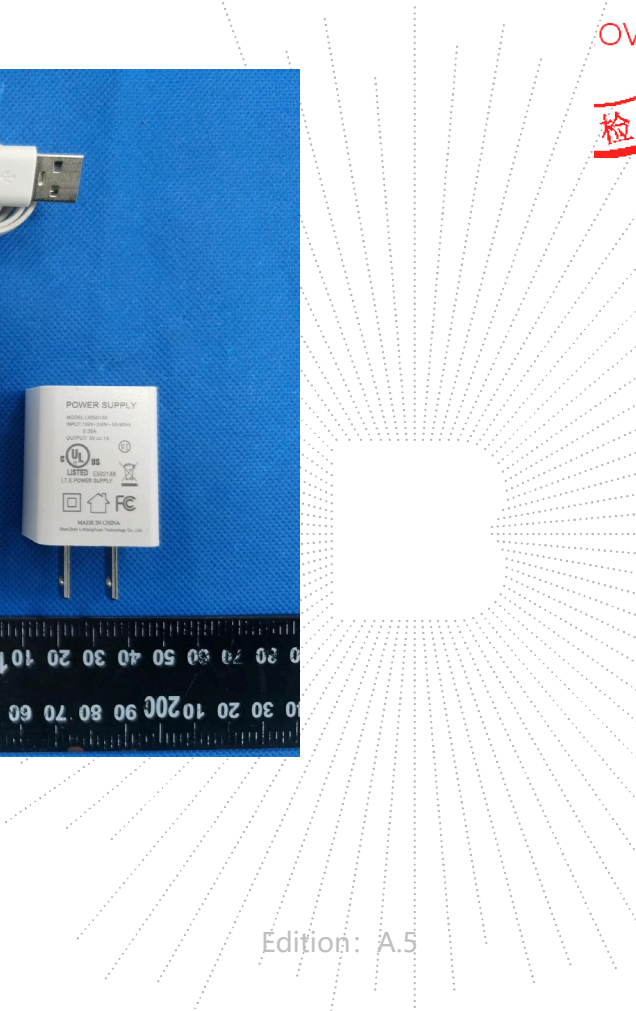

12. EUT Test Setup Photographs

Conducted Emissions Photo



Radiated Measurement Photos

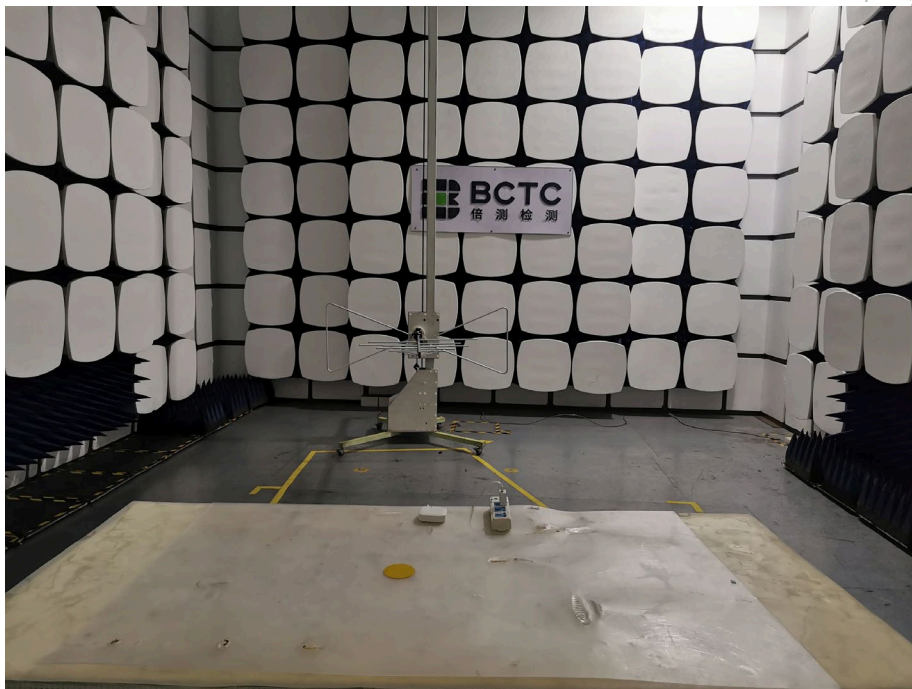

EST
C
ED
测

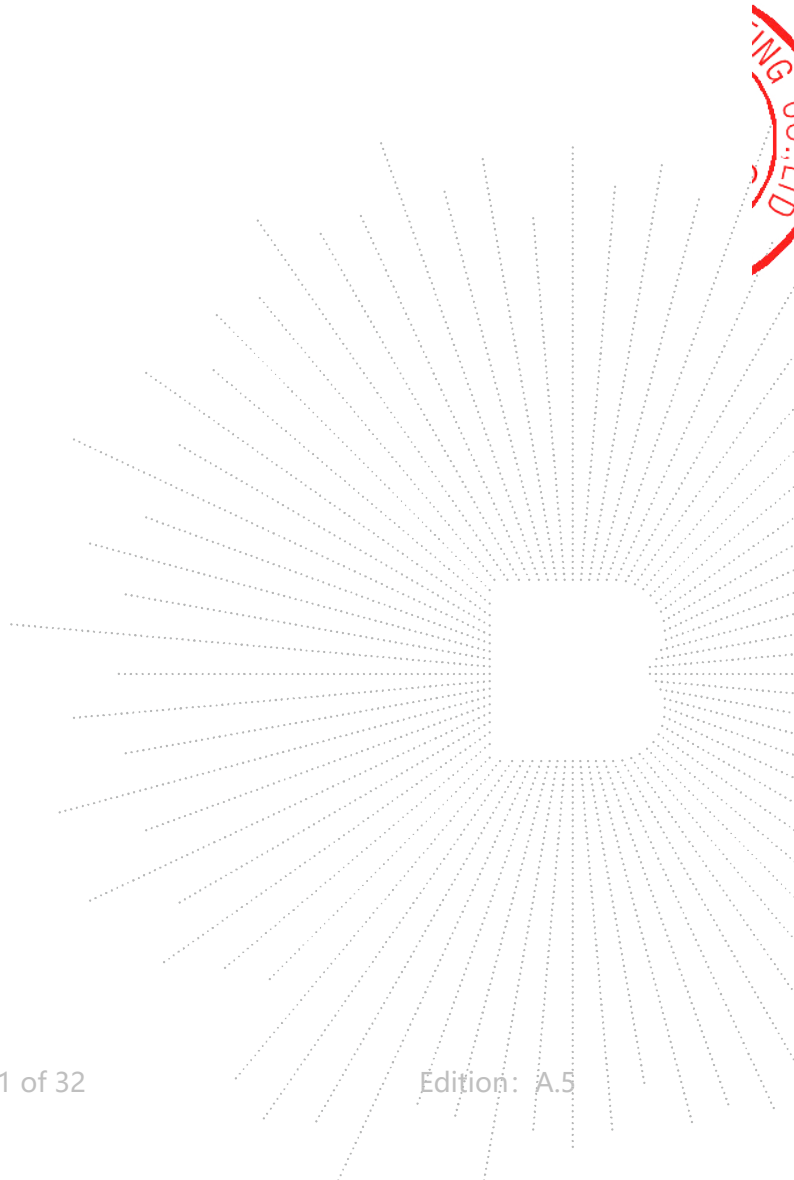
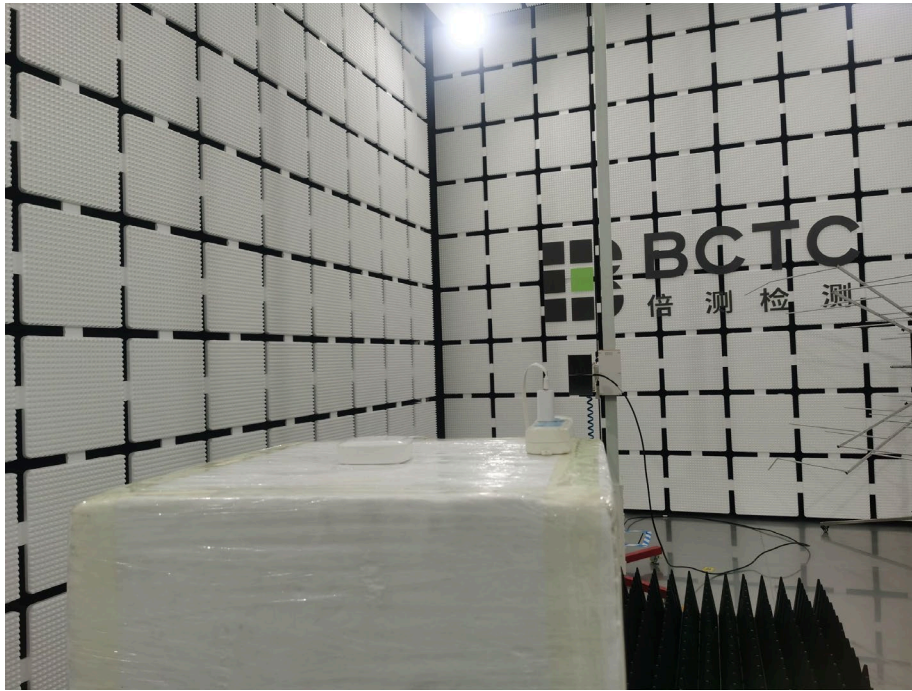

STATEMENT

1. The equipment lists are traceable to the national reference standards.
2. The test report can not be partially copied unless prior written approval is issued from our lab.
3. The test report is invalid without the "special seal for inspection and testing".
4. The test report is invalid without the signature of the approver.
5. The test process and test result is only related to the Unit Under Test.
6. Sample information is provided by the client and the laboratory is not responsible for its authenticity.
7. The test report without CMA mark is only used for scientific research, teaching, enterprise product development and internal quality control purposes.
8. The quality system of our laboratory is in accordance with ISO/IEC17025.
9. If there is any objection to this test report, the client should inform issuing laboratory within 15 days from the date of receiving test report.

Address:

1-2/F., Building B, Pengzhou Industrial Park, No.158, Fuyuan 1st Road, Zhancheng, Fuhai Subdistrict, Bao'an District, Shenzhen, Guangdong, China

TEL: 400-788-9558

P.C.: 518103

FAX: 0755-33229357

Website: <http://www.chnbctc.com>

E-Mail: bctc@bctc-lab.com.cn

***** END *****

COPY