



# FCC RADIO TEST REPORT

Applicant : Aidialink Corp.  
Address : No. 6, Lising 6th Rd., Science Park, Hsinchu City,  
30078, Taiwan  
Equipment : RFID UHF Handheld Reader  
Model No. : AL-700  
Trade Name : AidiaLink  
FCC ID. : 2ATL GAL700

## I HEREBY CERTIFY THAT :

The sample was received on Jul. 02, 2020 and the testing was completed on Oct. 16, 2020 at CerpPASS Technology Corp. The test result refers exclusively to the test presented test model / sample. Without written approval of CerpPASS Technology Corp., the test report shall not be reproduced except in full.

Approved by:

Mark Liao / Supervisor

Laboratory Accreditation:

CerpPASS Technology Corporation Test Laboratory





## Contents

<b>1. Summary of Test Procedure and Test Results</b>	<b>5</b>
1.1 Applicable Standards	5
<b>2. Test Configuration of Equipment under Test</b>	<b>6</b>
2.1 Feature of Equipment under Test	6
2.2 Carrier Frequency of Channes	6
2.3 Test Mode & Test Software	7
2.4 Description of Test System	7
2.5 General Information of Test	8
2.6 Measurement Uncertainty	8
<b>3. Test Equipment and Ancillaries Used for Tests</b>	<b>9</b>
<b>4. Antenna Requirements</b>	<b>11</b>
4.1 Standard Applicable	11
4.2 Antenna Construction and Directional Gain	11
<b>5. Test of AC Power Line Conducted Emission</b>	<b>12</b>
5.1 Test Limit	12
5.2 Test Procedures	12
5.3 Typical Test Setup	13
5.4 Test Result and Data	14
5.5 Test Photographs	16
<b>6. Test of Radiated Spurious Emission</b>	<b>17</b>
6.1 Test Limit	17
6.2 Test Procedures	17
6.3 Typical Test Setup	18
6.4 Test Result and Data (9kHz ~ 30MHz)	19
6.5 Test Result and Data (30MHz ~ 1GHz)	19
6.6 Test Result and Data (1GHz ~ 25GHz)	25
6.7 Restricted Bands of Operation	31
6.8 Test Photographs (30MHz ~ 1GHz)	32
6.9 Test Photographs (1GHz ~ 25GHz)	33
<b>7. Test of Conducted Spurious Emission</b>	<b>35</b>
7.1 Test Limit	35
7.2 Test Procedure	35
7.3 Test Setup Layout	35
7.4 Test Result and Data	35
<b>8. 20dB Bandwidth Measurement Data</b>	<b>38</b>
8.1 Test Limit	38
8.2 Test Procedures	38
8.3 Test Setup Layout	38
8.4 Test Result and Data	38
<b>9. Frequencies Separation</b>	<b>40</b>
9.1 Test Limit	40
9.2 Test Procedures	40



- 9.3 Test Setup Layout ..... 40
- 9.4 Test Result and Data ..... 40
- 10. Dwell Time on each channel ..... 42**
  - 10.1 Test Limit ..... 42
  - 10.2 Test Procedures ..... 42
  - 10.3 Test Setup Layout ..... 42
  - 10.4 Test Result and Data ..... 42
- 11. Number of Hopping Channels ..... 44**
  - 11.1 Test Limit ..... 44
  - 11.2 Test Procedures ..... 44
  - 11.3 Test Setup Layout ..... 44
  - 11.4 Test Result and Data ..... 44
- 12. Maximum Peak Output Power ..... 46**
  - 12.1 Test Limit ..... 46
  - 12.2 Test Procedures ..... 46
  - 12.3 Test Setup Layout ..... 46
  - 12.4 Test Result and Data ..... 47
- 13. Radio Frequency Exposure ..... 48**
  - 13.1 Applicable Standards ..... 48
  - 13.2 EUT Specification ..... 48





# 1. Summary of Test Procedure and Test Results

## 1.1 Applicable Standards

**ANSI C63.10:2013**

**FCC Rules and Regulations Part 15 Subpart C §15.247**

FCC Rule	Description of Test	Result
15.203	. Antenna Requirement	PASS
15.207	. AC Power Line Conducted Emission	PASS
15.209 15.205	. Radiated Spurious Emission	PASS
15.247(d)	. Conducted Spurious Emission	PASS
15.247(a)(1)	. Channel Carrier Frequencies Separation	PASS
15.247(a)(1)	. 20dB Bandwidth	PASS
15.247(a)(1)	. Dwell Time	PASS
15.247(b)	. Number of Hopping Channels	PASS
15.247(b)	. Peak Output Power Measurement Data	PASS

\*The lab has reduced the uncertainty risk factor from test equipment, environment and staff technicians which according to the standard on contract. Therefore, the test result will only be determined by standard requirement.

\*This EUT has been also tested and compiled with the requirement of FCC Part 15, Subpart B, recorded in a separate test report(TEFD2007006).



## 2. Test Configuration of Equipment under Test

### 2.1 Feature of Equipment under Test

Frequency Range	902MHz~928MHz
Type of Modulation	ASK
Antenna Type	Dielectric Ceramics
Antenna Gain	3.2dBi

Note: For more details, please refer to the User's manual of the EUT.

### 2.2 Carrier Frequency of Channes

Channel	Frequency (MHz)	Channel	Frequency (MHz)
<b>*01</b>	<b>903.24</b>	26	915.24
02	903.72	27	915.72
03	904.20	28	916.20
04	904.68	29	916.68
05	905.16	30	917.16
06	905.64	31	917.64
07	906.12	32	918.12
08	906.60	33	918.60
09	907.08	34	919.08
10	907.56	35	919.56
11	908.04	36	920.04
12	908.52	37	920.52
13	909.00	38	921.00
14	909.48	39	920.48
15	909.96	40	921.96
16	910.44	41	922.44
17	910.92	42	922.92
18	911.40	43	923.04
19	911.88	44	923.88
20	912.36	45	924.36
21	912.84	46	924.84
22	913.32	47	925.32
23	913.80	48	925.80
24	914.28	49	926.28
<b>*25</b>	<b>914.76</b>	<b>*50</b>	<b>926.76</b>

Note: Channels remarked \* are selected to perform test.



### 2.3 Test Mode & Test Software

- a. During testing, the interface cables and equipment positions were varied according to ANSI C63.10
- b. The complete test system included Notebook and EUT for RF test.
- c. An executive program, "AL-700 Utility ver.1.6" under Android system was executed to transmit and receive data via RFID.
- d. The following test modes were performed for the test:  
Test Mode 1.RFID

### 2.4 Description of Test System

RF Conducted				
Equipment	Brand	Model	Length/Type	Power cord/Length/Type
Micro USB Cable	kolin	KEX-DLCP07	1m / NS	N/A
Adapter	SAMSUNG	EP-TA20JBS	NA	NA
Radiated Emissions				
Equipment	Brand	Model	Length/Type	Power cord/Length/Type
Micro USB Cable	kolin	KEX-DLCP07	1m / NS	N/A
Adapter	SAMSUNG	EP-TA20JBS	NA	NA
AC Power Line Conducted Emission				
Equipment	Brand	Model	Length/Type	Power cord/Length/Type
Micro USB Cable	kolin	KEX-DLCP07	1m / NS	N/A
Adapter	SAMSUNG	EP-TA20JBS	NA	NA



## 2.5 General Information of Test

Test Site	<b>CerpPASS Technology Corporation Test Laboratory</b> Address: No.10, Ln. 2, Lianfu St., Luzhu Dist., Taoyuan City 33848, Taiwan (R.O.C.) Tel:+886-3-3226-888 Fax:+886-3-3226-881	
	FCC	TW1439, TW1079
	IC	4934E-1, 4934E-2
	VCCI	T-2205 for Telecommunication test C-4663 for Conducted emission test R-4218 for Radiated emission test G-10812, G-10813 for radiated disturbance above 1GHz
Frequency Range Investigated:	Conducted: from 150kHz to 30 MHz Radiation: from 30 MHz to 40,000MHz	
Test Distance:	The test distance of radiated emission from antenna to EUT is 3 M.	

Test Item	Test Site	Finish Date	Environmental Conditions	Tested By
RF Conducted	RFCON01-NK	2020/10/16	26°C / 50%	Nick Guan
Radiated Emissions	3M02-NK	2020/08/21	24°C / 48%	Nick Guan
AC Power Line Conducted Emission	CON01-NK	2020/08/23	30°C / 50%	Leon Huang

## 2.6 Measurement Uncertainty

Measurement Item	Uncertainty
AC Power Line Conduction(150K~30MHz)	±1.60dB
Radiated Spurious Emission(9KHz~30MHz)	±3.404dB
Radiated Spurious Emission(30MHz~1GHz)	±5.690dB
Radiated Spurious Emission(1GHz~18GHz)	±6.434dB
20dB Bandwidth	±4.646%
Occupied Bandwidth	±4.735%
Deactivation Time	±3.73%
Conducted Spurious Emission	±2.022dB
Peak Output Power(Conducted Power Meter)	±1.02dB





### 3. Test Equipment and Ancillaries Used for Tests

Test Item	Radiated Emissions				
Test Site	Semi Anechoic Room(3M02-NK)				
Instrument	Manufacturer	Model No	Serial No	Calibration Date	Valid Date
Bilog Antenna	Schwarzbeck	VULB9168	275	2019/09/24	2020/09/23
Active Loop Antenna	EMCO	6507	40855	2020/05/21	2021/05/20
Horn Antenna	EMCO	3115	31589	2020/03/26	2021/03/25
Horn Antenna	EMCO	3116	31974	2019/09/17	2020/09/16
EMI Receiver	ROHDE & SCHWARZ	ESCI	100821	2019/09/16	2020/09/15
Spectrum Analyzer	ROHDE & SCHWARZ	FSV 40-N	102151	2020/08/03	2021/08/02
Preamplifier	EM Electronics corp.	EM330	60660	2020/03/16	2021/03/15
Preamplifier	EMC INSTRUMENTS	EMC051845SE	980333	2019/09/20	2020/09/19
Preamplifier	Agilent	8449B	3008A01954	2020/03/16	2021/03/15
Preamplifier	EMC INSTRUMENTS	EMC184045	980065	2019/11/07	2020/11/06
Bluetooth Tester	ROHDE & SCHWARZ	CBT	101133	2020/04/07	2021/04/06
Cable-3in1(30M-1G)	HARBOUR INDUSTRIES	LL142	CCE1316	2019/09/20	2020/09/19
Cable-0.5m(1G-18G)	HUBER SUHNER	SUCOFLEX 100	805443/4	2020/05/27	2021/05/26
Cable-3m(1G-18G)	HUBER SUHNER	SUCOFLEX 100	805796/4	2020/05/27	2021/05/26
Cable-8m(1G-18G)	HUBER SUHNER	SUCOFLEX 100	805795/4	2020/05/27	2021/05/26
Cable-0.5m(30M-40G)	HUBER SUHNER	SUCOFLEX 102	28420/2	2020/04/01	2021/03/31
Cable-3m(30M-40G)	HUBER SUHNER	SUCOFLEX 102	MY2608/2	2020/04/01	2021/03/31
Cable-0.5m(1G-40G)	Rapidtek	40GHZ 50CM	38MS-38MS50314	2020/04/09	2021/04/08
E3	AUDIX	v8.2014-8-6	RK-000529	NA	NA

Test Item	RF Conducted				
Test Site	RFCON01-NK				
Instrument	Manufacturer	Model No	Serial No	Calibration Date	Valid Date
Spectrum Analyzer	ROHDE & SCHWARZ	FSV 40-N	101329	2020/07/07	2021/07/06
Bluetooth Tester	ROHDE & SCHWARZ	CBT	101133	2020/04/07	2021/04/06
CAX Signal Analyzer	KEYSIGHT	N9000B	MY57100339	2019/11/25	2020/11/24
Attenuator	KEYSIGHT	8491B	MY39250703	2020/04/17	2021/04/16
TEMP & HUMIDITY CHAMBER	T-MACHINE	TMJ-9712	T-12-040111	2020/08/25	2021/08/24
Power Meter	Anritsu	ML2495A	1224005	2020/04/17	2021/04/16
Power Sensor	Anritsu	MA2411B	1207295	2020/04/17	2021/04/16



Test Item	AC Power Line Conducted Emission				
Test Site	CON01-NK				
<b>Instrument</b>	<b>Manufacturer</b>	<b>Model No</b>	<b>Serial No</b>	<b>Calibration Date</b>	<b>Valid Date</b>
EMI Receiver	ROHDE & SCHWARZ	ESCI	100821	2019/09/16	2020/09/15
Line Impedance Stabilization Network	Schwarzbeck	NSLK 8127	8127-516	2019/09/19	2020/09/18
Pulse Limiter	ROHDE & SCHWARZ	ESH3-Z2	101933	2019/09/11	2020/09/10
Cable-6m(9k~300M)	NA	EMC5D-BM-BM-6	130605	2019/09/11	2020/09/10
E3	AUDIX	v8.2014-8-6	RK-000531	NA	NA



## 4. Antenna Requirements

### 4.1 Standard Applicable

For intentional device, according to FCC 47 CFR Section 15.203, an intentional radiator shall be designed to ensure that no antenna other than that furnished by the responsible party shall be used with the device.

And according to FCC 47 CFR Section 15.247 (b), if transmitting antennas of directional gain greater than 6dBi are used, the power shall be reduced by the amount in dB that the directional gain of the antenna exceeds 6dBi.

### 4.2 Antenna Construction and Directional Gain

Antenna Type	Dielectric Ceramics
Antenna Gain	3.2 dBi

Directional gain greater than 6dBi are used, the power limit shall be reduced by 1 dB.



## 5. Test of AC Power Line Conducted Emission

### 5.1 Test Limit

Conducted Emissions were measured from 150 kHz to 30 MHz with a bandwidth of 9 KHz, according to the methods defined in ANSI C63.4-2014. The EUT was placed on a nonmetallic stand in a shielded room 0.8 meters above the ground plane. The interface cables and equipment positioning were varied within limits of reasonable applications to determine the position produced maximum conducted emissions.

Frequency (MHz)	Quasi Peak (dB $\mu$ V)	Average (dB $\mu$ V)
0.15 – 0.5	66-56*	56-46*
0.5 – 5.0	56	46
5.0 – 30.0	60	50

\*Decreases with the logarithm of the frequency.

### 5.2 Test Procedures

- a. The EUT was placed 0.4 meter from the conducting wall of the shielding room was kept at least 80 centimeters from any other grounded conducting surface.
- b. Connect EUT to the power mains through a line impedance stabilization network (LISN).
- c. All the support units are connecting to the other LISN.
- d. The LISN provides 50 ohm coupling impedance for the measuring instrument.
- e. The FCC states that a 50 ohm, 50 micro-Henry LISN should be used.
- f. Both sides of AC line were checked for maximum conducted interference.
- g. The frequency range from 150 kHz to 30 MHz was searched.
- h. Set the test-receiver system to Peak Detect Function and Specified Bandwidth with Maximum Hold Mode.



### 5.3 Typical Test Setup

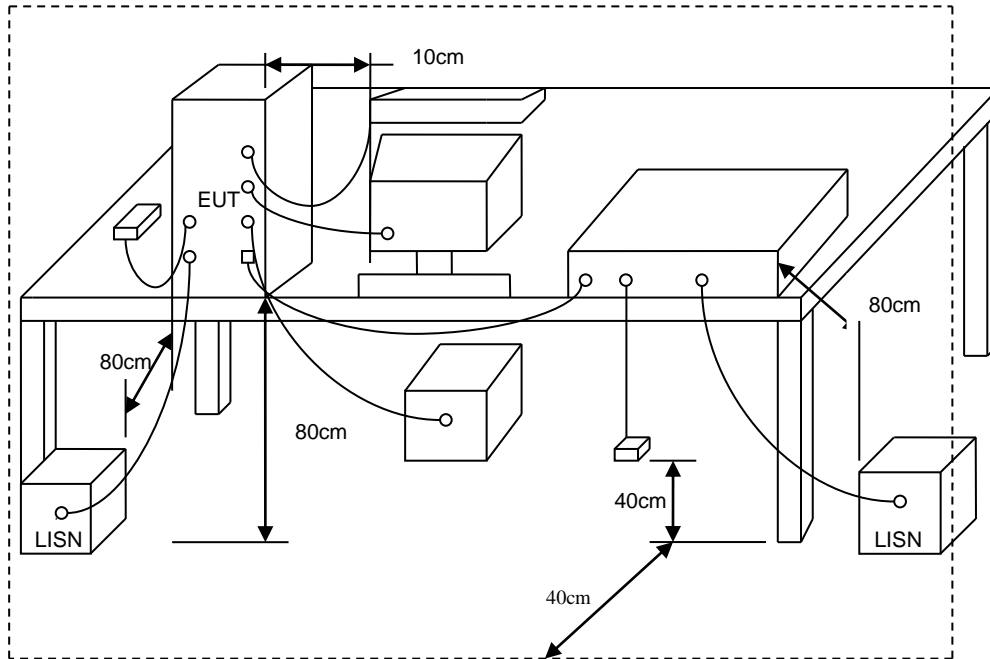



5.4 Test Result and Data

Power	: AC 120V / 60Hz	Pol/Phase	: LINE
Test Mode	: Mode 1		:

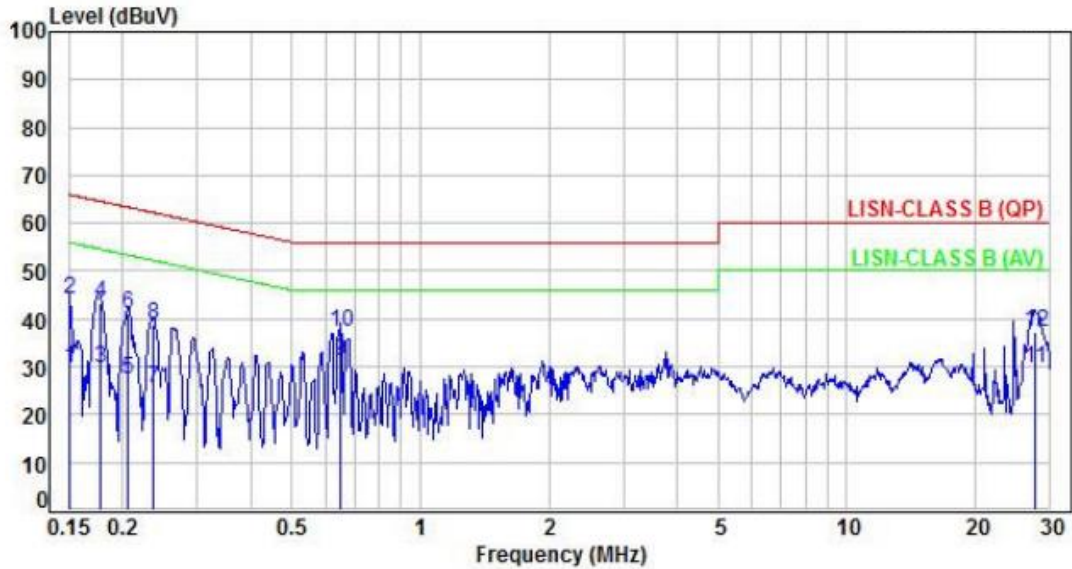

No.	Frequency (MHz)	Factor (dB)	Reading (dBuV)	Level (dBuV)	Limit (dBuV)	Margin (dB)	Detector	P/F
1	0.15	10.03	19.75	29.78	55.99	-26.21	Average	P
2	0.15	10.03	33.94	43.97	65.99	-22.02	QP	P
3	0.18	10.03	19.78	29.81	54.60	-24.79	Average	P
4	0.18	10.03	33.46	43.49	64.60	-21.11	QP	P
5	0.21	10.03	17.49	27.52	53.38	-25.86	Average	P
6	0.21	10.03	31.03	41.06	63.38	-22.32	QP	P
7	0.24	10.03	15.48	25.51	52.25	-26.74	Average	P
8	0.24	10.03	28.82	38.85	62.25	-23.40	QP	P
9	0.65	10.08	21.16	31.24	46.00	-14.76	Average	P
10	0.65	10.08	27.12	37.20	56.00	-18.80	QP	P
11	27.60	10.96	18.69	29.65	50.00	-20.35	Average	P
12	27.60	10.96	26.14	37.10	60.00	-22.90	QP	P

Note: Level=Reading+Factor  
 Margin=Level-Limit  
 Factor=(LISN or ISN or Current Probe)Factor + Cable Loss



Power	: AC 120V / 60Hz	Pol/Phase	: NEUTRAL
Test Mode	: Mode 1		

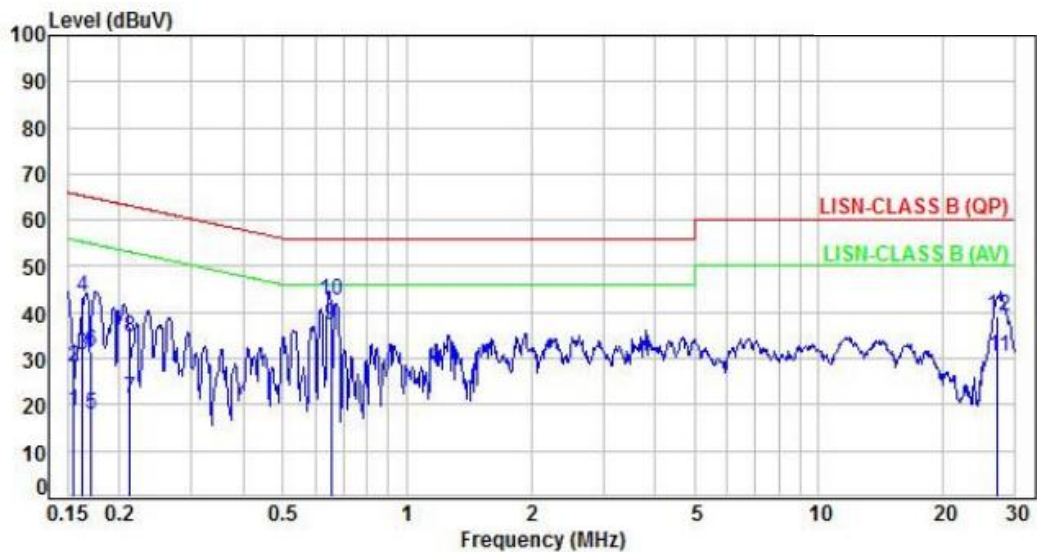

No.	Frequency (MHz)	Factor (dB)	Reading (dBuV)	Level (dBuV)	Limit (dBuV)	Margin (dB)	Detector	P/F
1	0.15	10.00	8.66	18.66	55.76	-37.10	Average	P
2	0.15	10.00	18.11	28.11	65.76	-37.65	QP	P
3	0.16	10.00	20.66	30.66	55.31	-24.65	Average	P
4	0.16	10.00	33.22	43.22	65.31	-22.09	QP	P
5	0.17	10.00	7.79	17.79	54.93	-37.14	Average	P
6	0.17	10.00	21.63	31.63	64.93	-33.30	QP	P
7	0.21	10.00	11.43	21.43	53.12	-31.69	Average	P
8	0.21	10.00	24.55	34.55	63.12	-28.57	QP	P
9	0.65	10.04	27.14	37.18	46.00	-8.82	Average	P
10	0.65	10.04	32.56	42.60	56.00	-13.40	QP	P
11	27.21	10.95	19.55	30.50	50.00	-19.50	Average	P
12	27.21	10.95	28.36	39.31	60.00	-20.69	QP	P

Note: Level=Reading+Factor  
 Margin=Level-Limit  
 Factor=(LISN or ISN or Current Probe)Factor + Cable Loss



## 6. Test of Radiated Spurious Emission

### 6.1 Test Limit

In any 100kHz bandwidth outside the frequency band in which the spread spectrum or digitally modulated intentional radiator is operating, the radio frequency power that is produced by the intentional radiator shall be at least 20dB below that in the 100kHz bandwidth within the band that contains the highest level of the desired power, based on either an RF conducted or a radiated measurement. If the transmitter measurement is based on the maximum conducted output power, the attenuation required under this paragraph shall be 30dB instead of 20dB. In addition, radiated emissions which fall in section 15.205(a) the restricted bands must also comply with the radiated emission limit specified in section 15.209(a).

Frequency (MHz)	Field Strength (microvolt/meter)	Measurement Distance (meters)
0.009 ~ 0.490	2400/F(kHz)	300
0.490 ~ 1.705	24000/F(kHz)	30
1.705 ~ 30.0	30	30
30 ~ 88	100	3
88 ~ 216	150	3
216 ~ 960	200	3
Above 960	500	3

### 6.2 Test Procedures

- The EUT was placed on a rotatable table top 0.8 meter above ground.
- The EUT was set 3 meters from the interference receiving antenna which was mounted on the top of a variable height antenna tower.
- The table was rotated 360 degrees to determine the position of the highest radiation.
- The antenna is a broadband antenna and its height is varied between one meter and four meters above ground to find the maximum value of the field strength both horizontal polarization and vertical polarization of the antenna are set to make the measurement.
- For each suspected emission the EUT was arranged to its worst case and then tune the antenna tower (from 1 M to 4 M) and turn table (from 0 degree to 360 degrees) to find the maximum reading.
- Set the test-receiver system to Peak or CISPR quasi-peak Detect Function and specified bandwidth with Maximum Hold Mode.
- If the emission level of the EUT in peak mode was 3 dB lower than the limit specified, then testing will be stopped and peak values of EUT will be reported, otherwise, the emissions which do not have 3 dB margin will be repeated one by one using the quasi-peak method and reported.
- For testing above 1GHz, the emission level of the EUT in peak mode was 20dB lower than average limit (that means the emission level in peak mode also complies with the limit in average mode), then testing will be stopped and peak values of EUT will be reported, otherwise, the emissions will be measured in average mode again and reported.





### 6.3 Typical Test Setup

Below 30MHz test setup

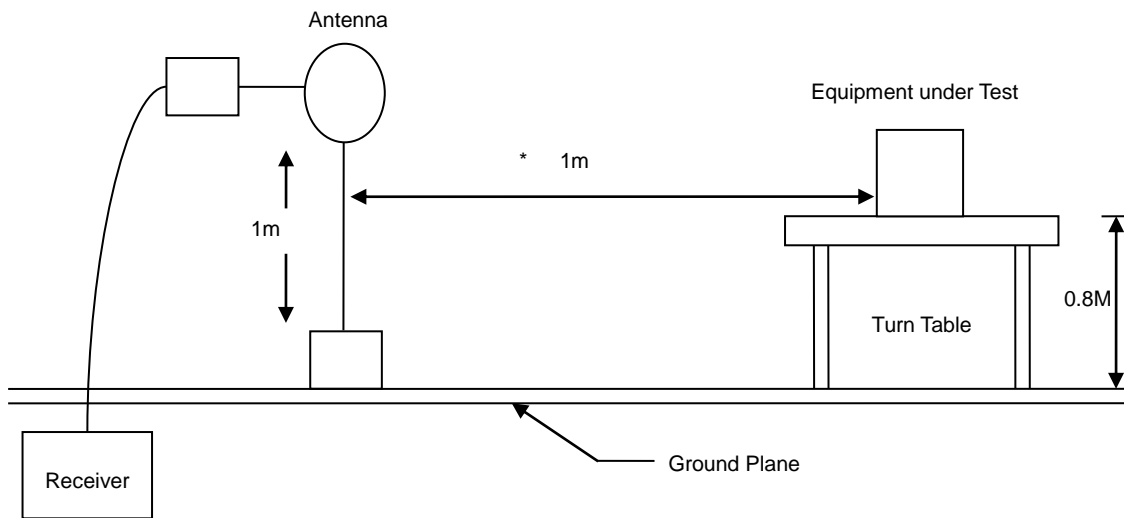

30MHz- 1GHz Test Setup

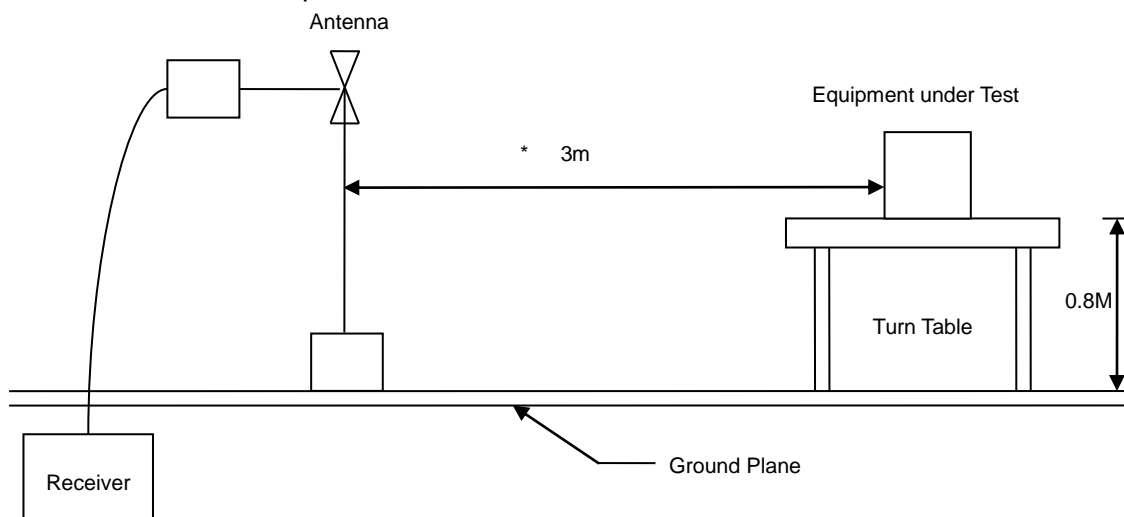

Above 1GHz Test Setup

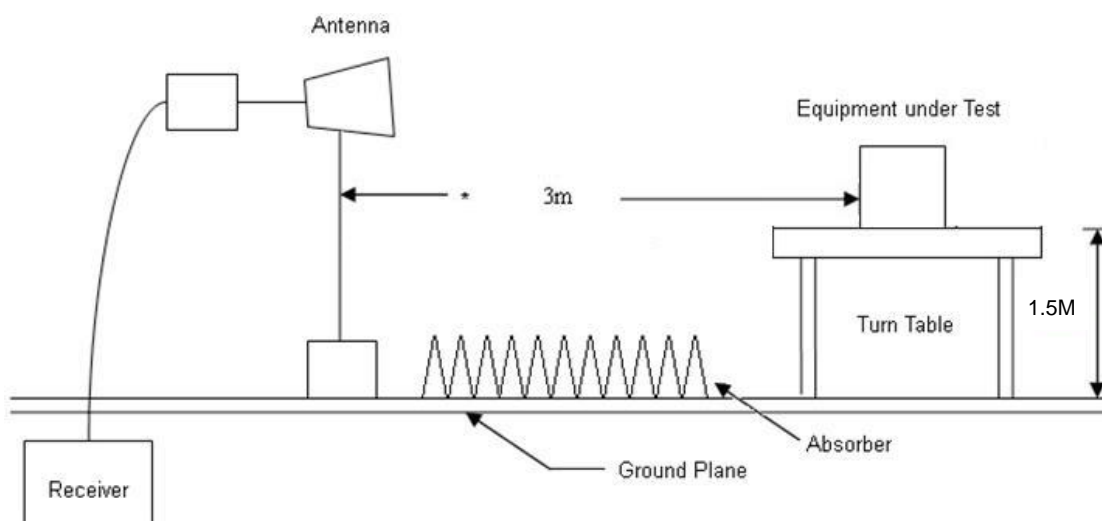



### 6.4 Test Result and Data (9kHz ~ 30MHz)

The 9kHz-30MHz spurious emission is under limit 20dB more.

### 6.5 Test Result and Data (30MHz ~ 1GHz)

Power	: AC 120V / 60Hz	Pol/Phase	: VERTICAL
Test Mode	: Mode 1, CH01		:

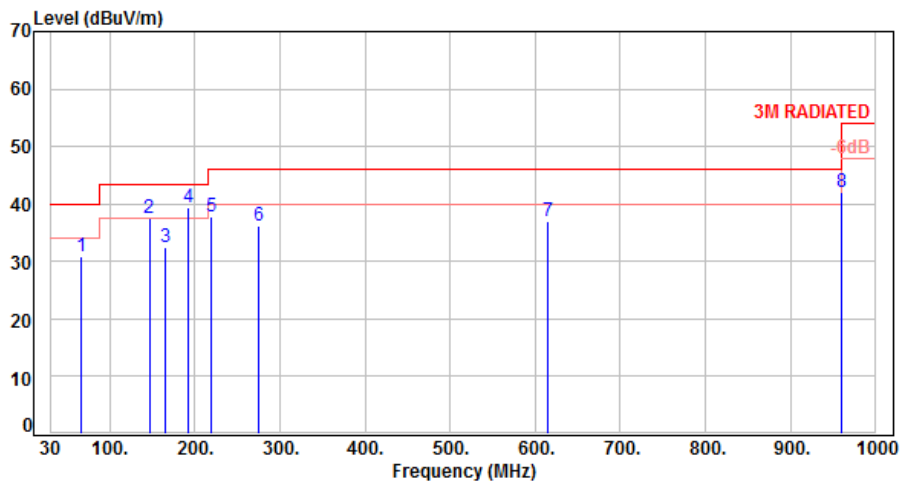

No.	Frequency (MHz)	Factor (dB)	Reading (dBuV)	Level (dBuV/m)	Limit (dBuV/m)	Margin (dB)	Detector	Height (cm)	Azimuth (deg)	P/F
1	65.89	19.82	11.10	30.92	40.00	-9.08	Peak	400	0	P
2	146.40	20.88	16.63	37.51	43.50	-5.99	Peak	400	0	P
3	164.83	21.10	11.42	32.52	43.50	-10.98	Peak	400	0	P
4	191.99	18.70	20.66	39.36	43.50	-4.14	Peak	400	0	P
5	219.15	18.89	18.82	37.71	46.00	-8.29	Peak	400	0	P
6	274.44	21.21	14.93	36.14	46.00	-9.86	Peak	400	0	P
7	614.00	28.72	8.34	37.06	46.00	-8.94	Peak	400	0	P
8	960.00	33.38	8.61	41.99	46.00	-4.01	Peak	400	0	P

Note: Level=Reading+Factor  
Margin=Level-Limit  
Factor=Antenna Factor + cable loss - Amplifier Factor



Power	: AC 120V / 60Hz	Pol/Phase	: HORIZONTAL
Test Mode	: Mode 1, CH01		:

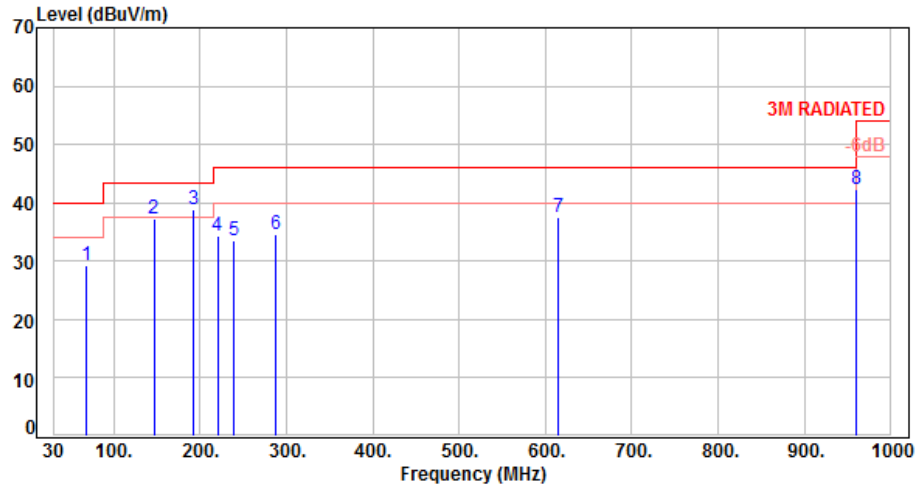

No.	Frequency (MHz)	Factor (dB)	Reading (dBuV)	Level (dBuV/m)	Limit (dBuV/m)	Margin (dB)	Detector	Height (cm)	Azimuth (deg)	P/F
1	67.83	19.53	9.69	29.22	40.00	-10.78	Peak	100	0	P
2	146.40	20.88	16.44	37.32	43.50	-6.18	Peak	100	0	P
3	191.99	18.70	20.13	38.83	43.50	-4.67	Peak	100	0	P
4	220.12	18.89	15.56	34.45	46.00	-11.55	Peak	100	0	P
5	239.52	19.81	13.82	33.63	46.00	-12.37	Peak	100	0	P
6	288.02	21.57	13.08	34.65	46.00	-11.35	Peak	100	0	P
7	614.00	28.72	8.87	37.59	46.00	-8.41	Peak	100	0	P
8	960.00	33.38	8.89	42.27	46.00	-3.73	Peak	100	0	P

Note: Level=Reading+Factor  
 Margin=Level-Limit  
 Factor=Antenna Factor + cable loss - Amplifier Factor



Power	: AC 120V / 60Hz	Pol/Phase	: VERTICAL
Test Mode	: Mode 1, CH25		:

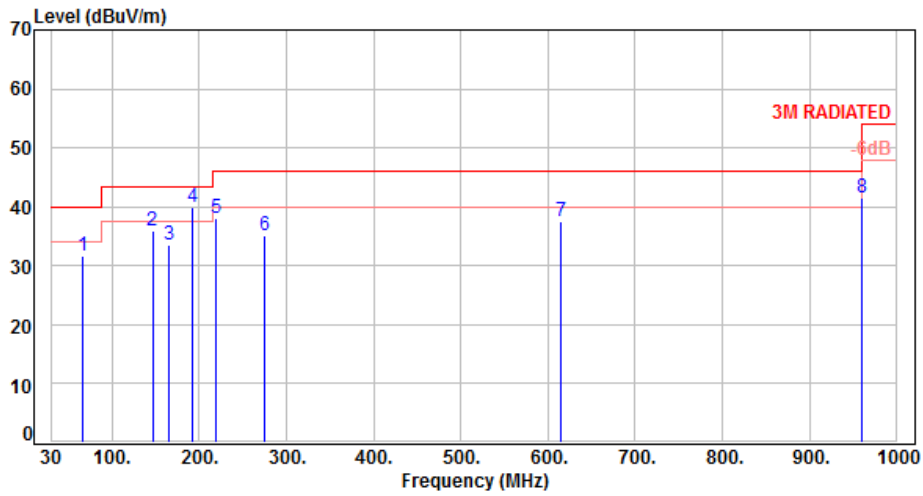

No.	Frequency (MHz)	Factor (dB)	Reading (dBuV)	Level (dBuV/m)	Limit (dBuV/m)	Margin (dB)	Detector	Height (cm)	Azimuth (deg)	P/F
1	65.89	19.82	11.75	31.57	40.00	-8.43	Peak	400	0	P
2	146.40	20.88	15.08	35.96	43.50	-7.54	Peak	400	0	P
3	164.83	21.10	12.54	33.64	43.50	-9.86	Peak	400	0	P
4	191.99	18.70	21.12	39.82	43.50	-3.68	Peak	400	0	P
5	219.15	18.89	19.27	38.16	46.00	-7.84	Peak	400	0	P
6	274.44	21.21	13.82	35.03	46.00	-10.97	Peak	400	0	P
7	614.00	28.72	8.90	37.62	46.00	-8.38	Peak	400	0	P
8	960.00	33.38	8.12	41.50	46.00	-4.50	Peak	400	0	P

Note: Level=Reading+Factor  
 Margin=Level-Limit  
 Factor=Antenna Factor + cable loss - Amplifier Factor



Power	: AC 120V / 60Hz	Pol/Phase	: HORIZONTAL
Test Mode	: Mode 1, CH25		:

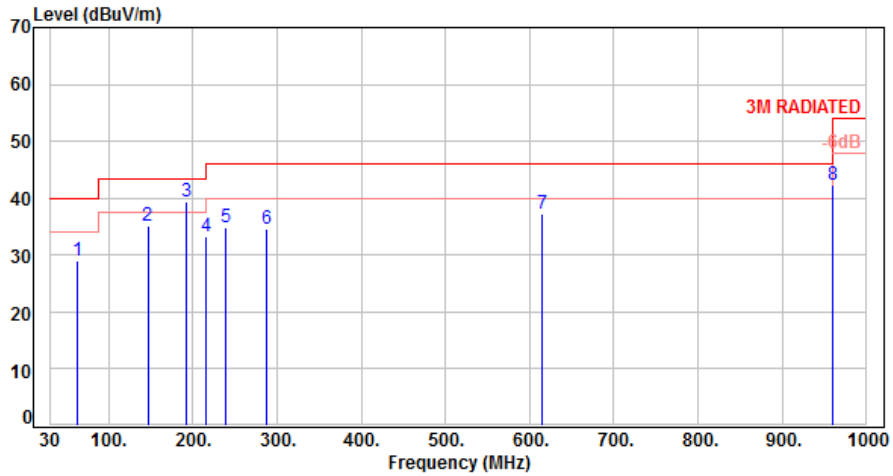

No.	Frequency (MHz)	Factor (dB)	Reading (dBuV)	Level (dBuV/m)	Limit (dBuV/m)	Margin (dB)	Detector	Height (cm)	Azimuth (deg)	P/F
1	62.98	20.37	8.77	29.14	40.00	-10.86	Peak	100	0	P
2	146.40	20.88	14.16	35.04	43.50	-8.46	Peak	100	0	P
3	191.99	18.70	20.69	39.39	43.50	-4.11	Peak	100	0	P
4	216.24	18.87	14.33	33.20	46.00	-12.80	Peak	100	0	P
5	239.52	19.81	15.18	34.99	46.00	-11.01	Peak	100	0	P
6	288.02	21.57	12.96	34.53	46.00	-11.47	Peak	100	0	P
7	614.00	28.72	8.44	37.16	46.00	-8.84	Peak	100	0	P
8	960.00	33.38	8.84	42.22	46.00	-3.78	Peak	100	0	P

Note: Level=Reading+Factor  
 Margin=Level-Limit  
 Factor=Antenna Factor + cable loss - Amplifier Factor



Power	: AC 120V / 60Hz	Pol/Phase	: VERTICAL
Test Mode	: Mode 1, CH50		:

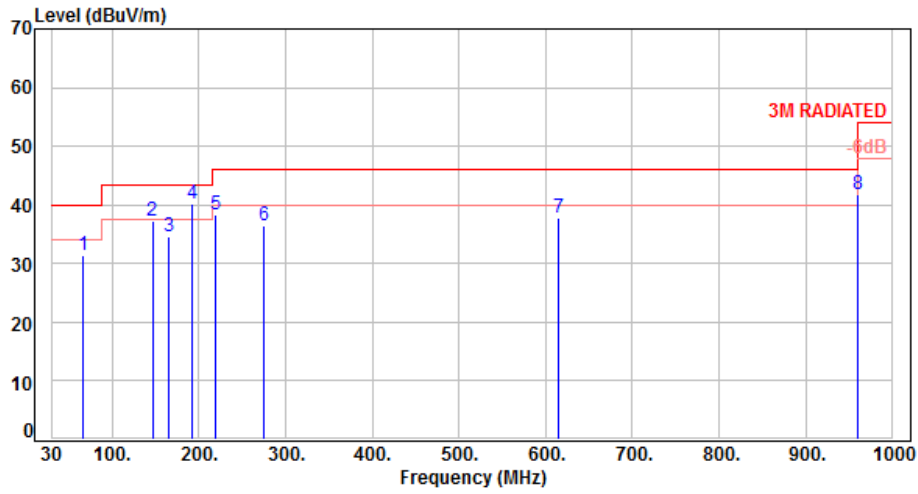

No.	Frequency (MHz)	Factor (dB)	Reading (dBuV)	Level (dBuV/m)	Limit (dBuV/m)	Margin (dB)	Detector	Height (cm)	Azimuth (deg)	P/F
1	65.89	19.82	11.62	31.44	40.00	-8.56	Peak	400	0	P
2	146.40	20.88	16.30	37.18	43.50	-6.32	Peak	400	0	P
3	164.83	21.10	13.63	34.73	43.50	-8.77	Peak	400	0	P
4	191.99	18.70	21.61	40.31	43.50	-3.19	Peak	400	0	P
5	219.15	18.89	19.40	38.29	46.00	-7.71	Peak	400	0	P
6	274.44	21.21	15.36	36.57	46.00	-9.43	Peak	400	0	P
7	614.00	28.72	9.12	37.84	46.00	-8.16	Peak	400	0	P
8	960.00	33.38	8.34	41.72	46.00	-4.28	Peak	400	0	P

Note: Level=Reading+Factor  
 Margin=Level-Limit  
 Factor=Antenna Factor + cable loss - Amplifier Factor



Power	: AC 120V / 60Hz	Pol/Phase	: HORIZONTAL
Test Mode	: Mode 1, CH50		:

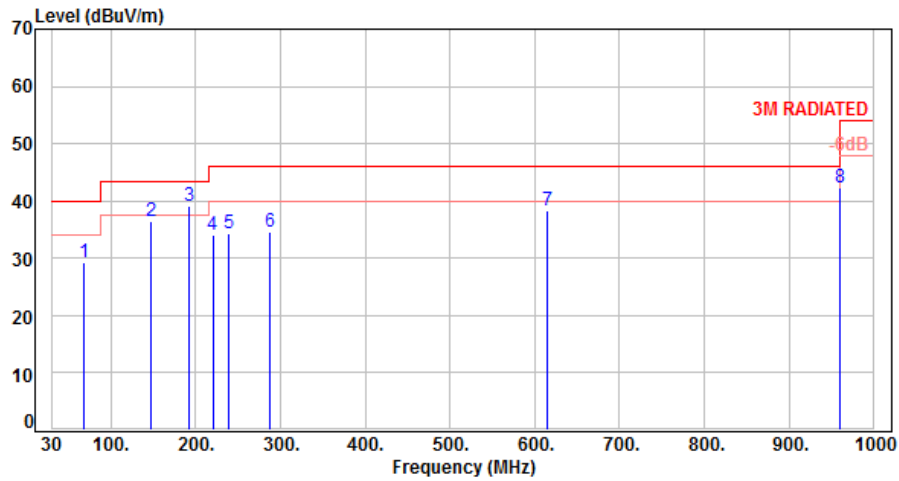

No.	Frequency (MHz)	Factor (dB)	Reading (dBuV)	Level (dBuV/m)	Limit (dBuV/m)	Margin (dB)	Detector	Height (cm)	Azimuth (deg)	P/F
1	67.83	19.53	9.76	29.29	40.00	-10.71	Peak	100	0	P
2	147.37	20.94	15.47	36.41	43.50	-7.09	Peak	100	0	P
3	191.99	18.70	20.48	39.18	43.50	-4.32	Peak	100	0	P
4	220.12	18.89	15.09	33.98	46.00	-12.02	Peak	100	0	P
5	239.52	19.81	14.56	34.37	46.00	-11.63	Peak	100	0	P
6	288.02	21.57	13.06	34.63	46.00	-11.37	Peak	100	0	P
7	614.00	28.72	9.65	38.37	46.00	-7.63	Peak	100	0	P
8	960.00	33.38	8.92	42.30	46.00	-3.70	Peak	100	0	P

Note: Level=Reading+Factor  
 Margin=Level-Limit  
 Factor=Antenna Factor + cable loss - Amplifier Factor



6.6 Test Result and Data (1GHz ~ 25GHz)

Power	: AC 120V / 60Hz	Pol/Phase	: VERTICAL
Test Mode	: Mode 1, CH01		

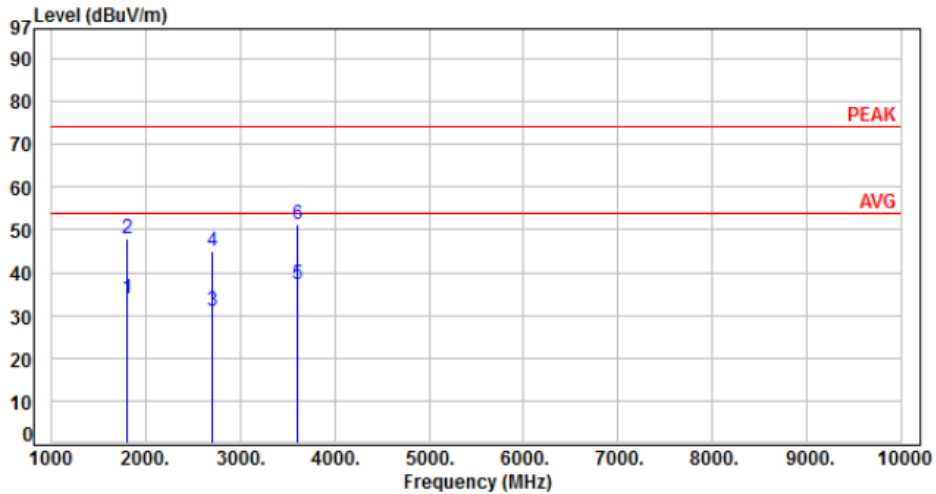

No.	Frequency (MHz)	Factor (dB)	Reading (dBuV)	Level (dBuV/m)	Limit (dBuV/m)	Margin (dB)	Detector	Height (cm)	Azimuth (deg)	P/F
1	1806.48	-5.59	39.54	33.95	54.00	-20.05	Average	128	244	P
2	1806.48	-5.59	53.65	48.06	74.00	-25.94	Peak	128	244	P
3	2709.72	-1.75	32.58	30.83	54.00	-23.17	Average	103	275	P
4	2709.72	-1.75	46.69	44.94	74.00	-29.06	Peak	103	275	P
5	3612.96	1.94	35.16	37.10	54.00	-16.90	Average	241	25	P
6	3612.96	1.94	49.27	51.21	74.00	-22.79	Peak	241	25	P

Note: Level=Reading+Factor  
Margin=Level-Limit  
Factor=Antenna Factor + cable loss - Amplifier Factor





Power	: AC 120V / 60Hz	Pol/Phase	: HORIZONTAL
Test Mode	: Mode 1, CH01		:

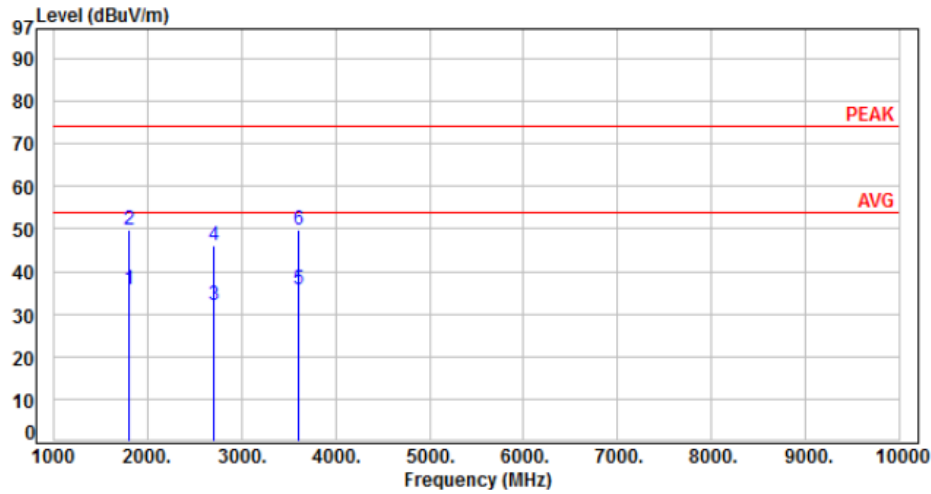

No.	Frequency (MHz)	Factor (dB)	Reading (dBuV)	Level (dBuV/m)	Limit (dBuV/m)	Margin (dB)	Detector	Height (cm)	Azimuth (deg)	P/F
1	1806.48	-5.59	41.29	35.70	54.00	-18.30	Average	108	29	P
2	1806.48	-5.59	55.40	49.81	74.00	-24.19	Peak	108	29	P
3	2709.72	-1.75	33.76	32.01	54.00	-21.99	Average	138	349	P
4	2709.72	-1.75	47.87	46.12	74.00	-27.88	Peak	138	349	P
5	3612.96	1.94	33.78	35.72	54.00	-18.28	Average	100	359	P
6	3612.96	1.94	47.89	49.83	74.00	-24.17	Peak	100	359	P

Note: Level=Reading+Factor  
 Margin=Level-Limit  
 Factor=Antenna Factor + cable loss - Amplifier Factor



Power	: AC 120V / 60Hz	Pol/Phase	: VERTICAL
Test Mode	: Mode 1, CH25		:

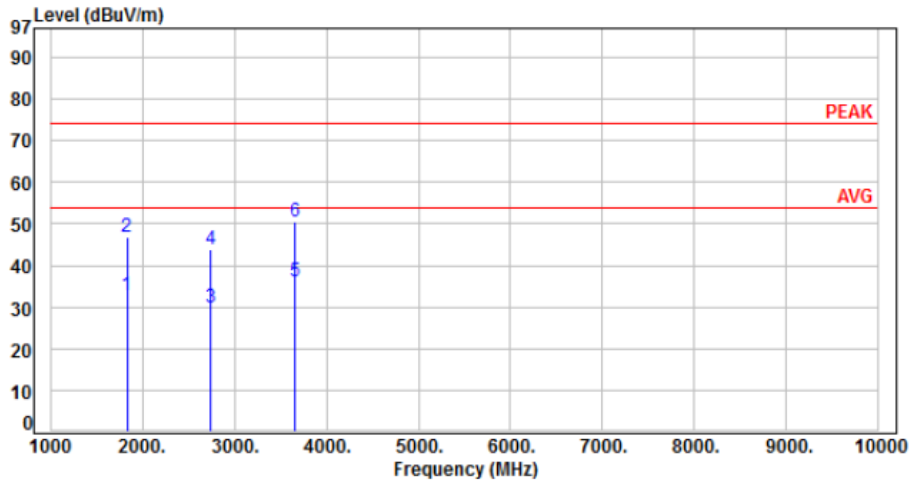

No.	Frequency (MHz)	Factor (dB)	Reading (dBuV)	Level (dBuV/m)	Limit (dBuV/m)	Margin (dB)	Detector	Height (cm)	Azimuth (deg)	P/F
1	1829.52	-5.30	38.19	32.89	54.00	-21.11	Average	123	230	P
2	1829.52	-5.30	52.30	47.00	74.00	-27.00	Peak	123	230	P
3	2744.28	-1.71	31.41	29.70	54.00	-24.30	Average	101	288	P
4	2744.28	-1.71	45.52	43.81	74.00	-30.19	Peak	101	288	P
5	3659.04	2.20	34.09	36.29	54.00	-17.71	Average	239	27	P
6	3659.04	2.20	48.20	50.40	74.00	-23.60	Peak	239	27	P

Note: Level=Reading+Factor  
 Margin=Level-Limit  
 Factor=Antenna Factor + cable loss - Amplifier Factor



Power	: AC 120V / 60Hz	Pol/Phase	: HORIZONTAL
Test Mode	: Mode 1, CH25		:

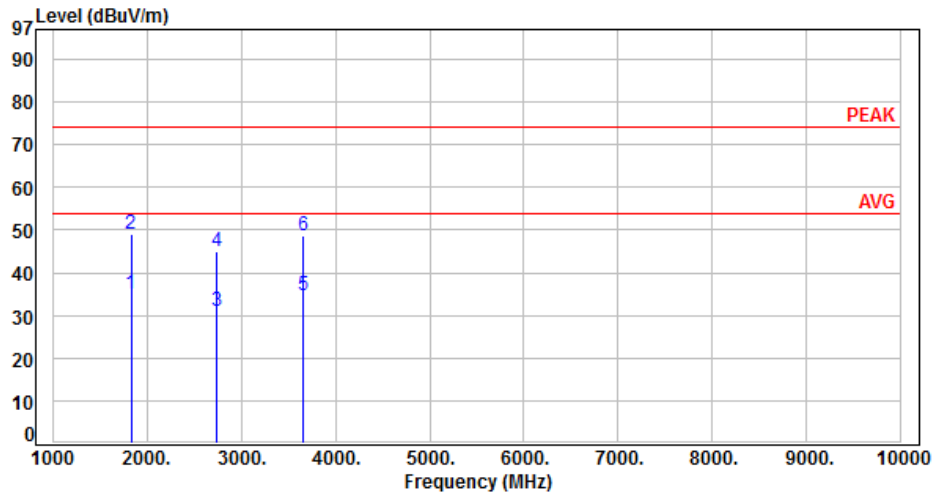

No.	Frequency (MHz)	Factor (dB)	Reading (dBuV)	Level (dBuV/m)	Limit (dBuV/m)	Margin (dB)	Detector	Height (cm)	Azimuth (deg)	P/F
1	1829.52	-5.30	40.17	34.87	54.00	-19.13	Average	106	34	P
2	1829.52	-5.30	54.28	48.98	74.00	-25.02	Peak	106	34	P
3	2744.28	-1.71	32.62	30.91	54.00	-23.09	Average	142	351	P
4	2744.28	-1.71	46.73	45.02	74.00	-28.98	Peak	142	351	P
5	3659.04	2.20	32.53	34.73	54.00	-19.27	Average	100	356	P
6	3659.04	2.20	46.64	48.84	74.00	-25.16	Peak	100	356	P

Note: Level=Reading+Factor  
 Margin=Level-Limit  
 Factor=Antenna Factor + cable loss - Amplifier Factor



Power	: AC 120V / 60Hz	Pol/Phase	: VERTICAL
Test Mode	: Mode 1, CH50		:

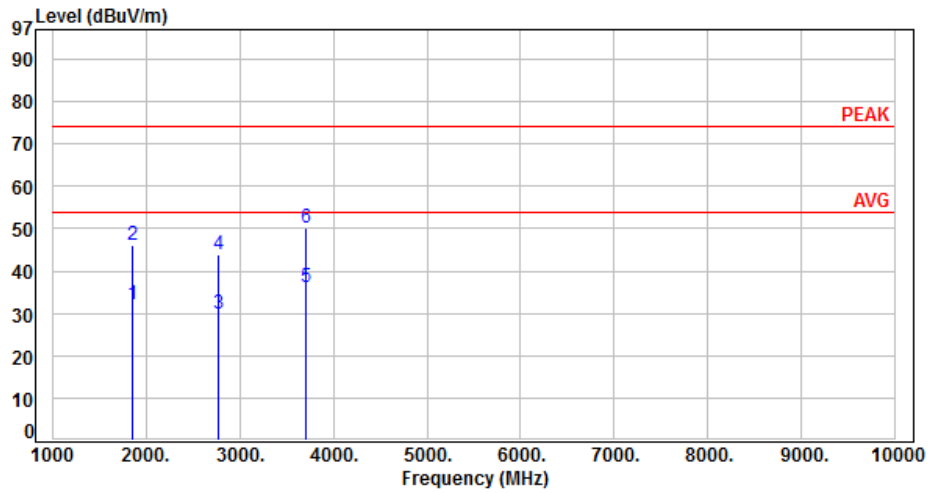

No.	Frequency (MHz)	Factor (dB)	Reading (dBuV)	Level (dBuV/m)	Limit (dBuV/m)	Margin (dB)	Detector	Height (cm)	Azimuth (deg)	P/F
1	1853.52	-5.00	36.98	31.98	54.00	-22.02	Average	100	224	P
2	1853.52	-5.00	51.09	46.09	74.00	-27.91	Peak	100	224	P
3	2780.28	-1.66	31.57	29.91	54.00	-24.09	Average	100	242	P
4	2780.28	-1.66	45.68	44.02	74.00	-29.98	Peak	100	242	P
5	3707.04	2.56	33.64	36.20	54.00	-17.80	Average	249	26	P
6	3707.04	2.56	47.75	50.31	74.00	-23.69	Peak	249	26	P

Note: Level=Reading+Factor  
 Margin=Level-Limit  
 Factor=Antenna Factor + cable loss - Amplifier Factor



Power	: AC 120V / 60Hz	Pol/Phase	: HORIZONTAL
Test Mode	: Mode 1, CH50		:

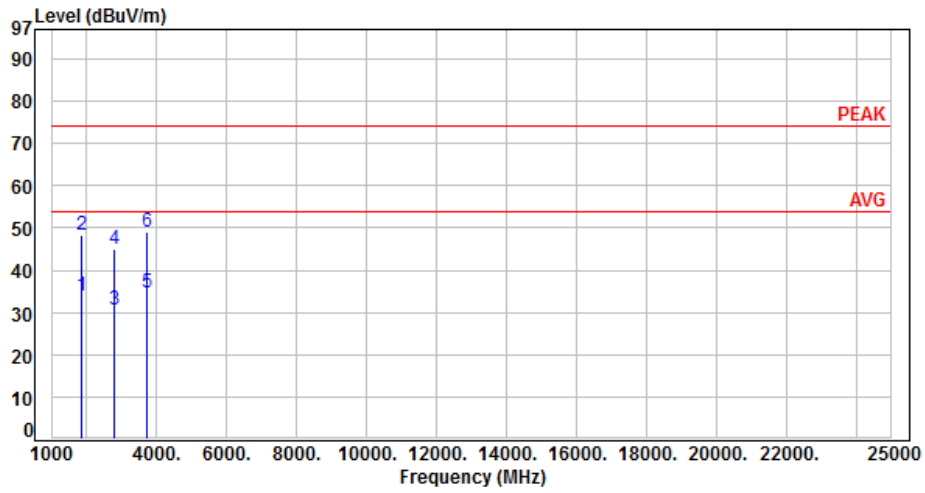

No.	Frequency (MHz)	Factor (dB)	Reading (dBuV)	Level (dBuV/m)	Limit (dBuV/m)	Margin (dB)	Detector	Height (cm)	Azimuth (deg)	P/F
1	1853.52	-5.00	39.02	34.02	54.00	-19.98	Average	100	39	P
2	1853.52	-5.00	53.13	48.13	74.00	-25.87	Peak	100	39	P
3	2780.28	-1.66	32.39	30.73	54.00	-23.27	Average	146	355	P
4	2780.28	-1.66	46.50	44.84	74.00	-29.16	Peak	146	355	P
5	3707.04	2.56	32.20	34.76	54.00	-19.24	Average	101	358	P
6	3707.04	2.56	46.31	48.87	74.00	-25.13	Peak	101	358	P

Note: Level=Reading+Factor  
 Margin=Level-Limit  
 Factor=Antenna Factor + cable loss - Amplifier Factor



### 6.7 Restricted Bands of Operation

Only spurious emissions are permitted in any of the frequency bands listed below:

MHz	MHz	MHz	GHz
0.09000 – 0.11000	16.42000 – 16.42300	399.9 – 410.0	4.500 – 5.250
0.49500 – 0.505**	16.69475 – 16.69525	608.0 – 614.0	5.350 – 5.460
2.17350 – 2.19050	16.80425 – 16.80475	960.0 – 1240.0	7.250 – 7.750
4.12500 – 4.12800	25.50000 – 25.67000	1300.0 – 1427.0	8.025 – 8.500
4.17725 – 4.17775	37.50000 – 38.25000	1435.0 – 1626.5	9.000 – 9.200
4.20725 – 4.20775	73.00000 – 74.60000	1645.5 – 1646.5	9.300 – 9.500
6.21500 – 6.21800	74.80000 – 75.20000	1660.0 – 1710.0	10.600 – 12.700
6.26775 – 6.26825	108.00000 – 121.94000	1718.8 – 1722.2	13.250 – 13.400
6.31175 – 6.31225	123.00000 – 138.00000	2200.0 – 2300.0	14.470 – 14.500
8.29100 – 8.29400	149.90000 – 150.05000	2310.0 – 2390.0	15.350 – 16.200
8.36200 – 8.36600	156.52475 – 156.52525	2483.5 – 2500.0	17.700 – 21.400
8.37625 – 8.38675	156.70000 – 156.90000	2655.0 – 2900.0	22.010 – 23.120
8.41425 – 8.41475	162.01250 – 167.17000	3260.0 – 3267.0	23.600 – 24.000
12.29000 – 12.29300	167.72000 – 173.20000	3332.0 – 3339.0	31.200 – 31.800
12.51975 – 12.52025	240.00000 – 285.00000	3345.8 – 3358.0	36.430 – 36.500
12.57675 – 12.57725	322.00000 – 335.40000	3600.0 – 4400.0	Above 38.6
13.36000 – 13.41000			

\*\* : Until February 1, 1999, this restricted band shall be 0.490-0.510 MHz



## 7. Test of Conducted Spurious Emission

### 7.1 Test Limit

Below -20dB of the highest emission level of operating band (in 100kHz Resolution Bandwidth).

### 7.2 Test Procedure

- a. The transmitter output was connected to the spectrum analyzer via a low loss cable.
- b. Set both RBW and VBW of spectrum analyzer to 100 KHz with convenient frequency span including 300 KHz bandwidth from band edge.
- c. The band edges was measured and recorded.

### 7.3 Test Setup Layout

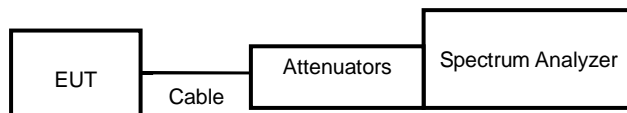

### 7.4 Test Result and Data

Note: Test plots refer to the following pages.



Modulation Type: ASK  
CH01

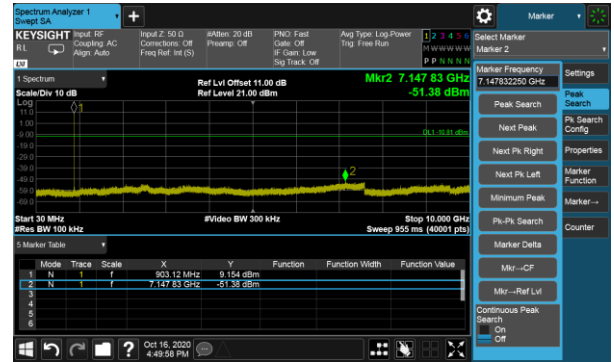
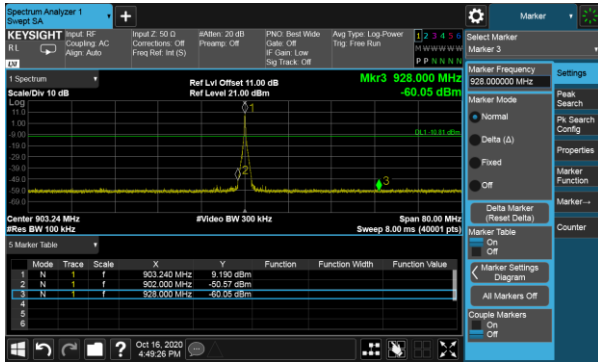

CH25

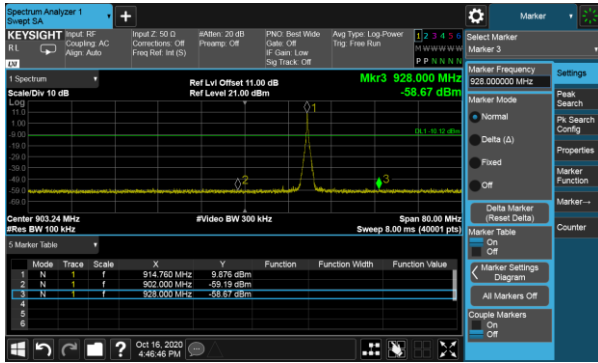

CH50

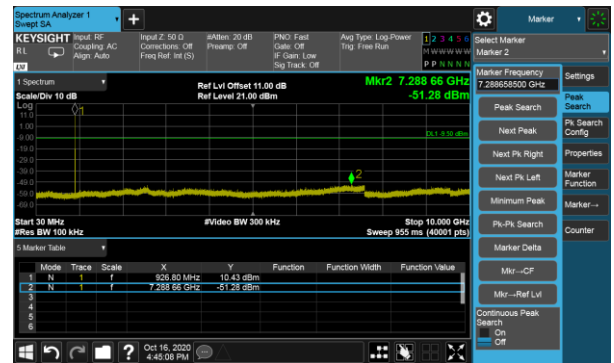
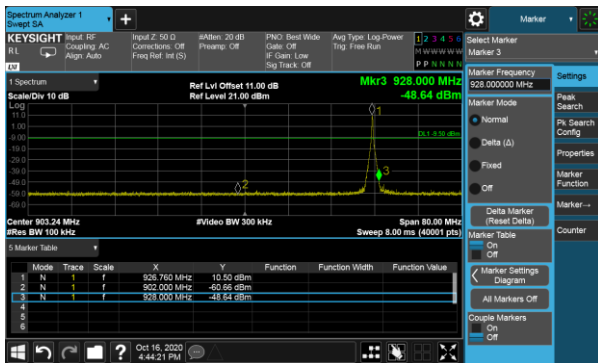





Modulation Type: ASK  
Hopping

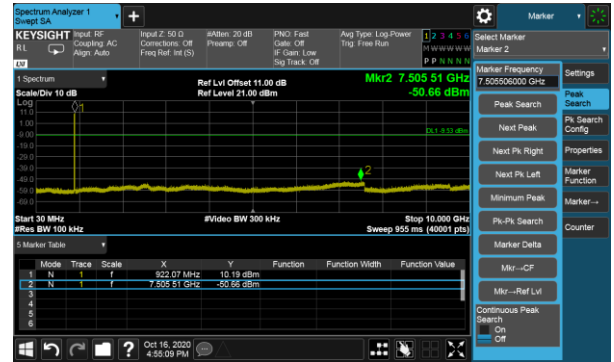
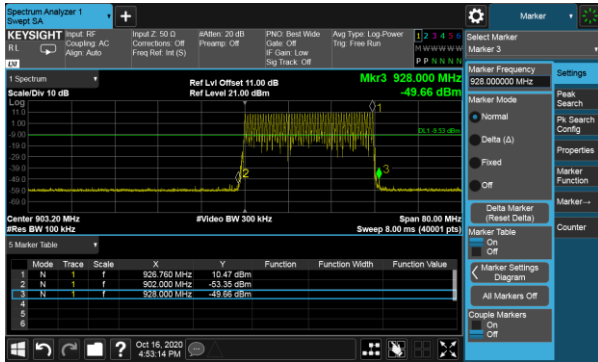



## 8. 20dB Bandwidth Measurement Data

### 8.1 Test Limit

The maximum allowed 20 dB bandwidth of the hopping channel is 500 kHz..

### 8.2 Test Procedures

- a. The transmitter output was connected to the spectrum analyzer.
- b. Set RBW of spectrum analyzer to 10 KHz and VBW to 30 KHz.
- c. The 20 dB bandwidth is defined as the total spectrum the power of which is higher than peak power minus 20 dB.

### 8.3 Test Setup Layout

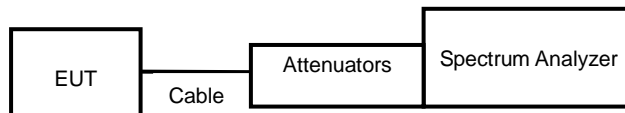

### 8.4 Test Result and Data

Modulation Type	Channel	Channel Frequency (MHz)	20dB Bandwidth (MHz)
ASK	1	903.24	0.168
	25	914.76	0.168
	50	926.76	0.168



Modulation Type: ASK  
CH01

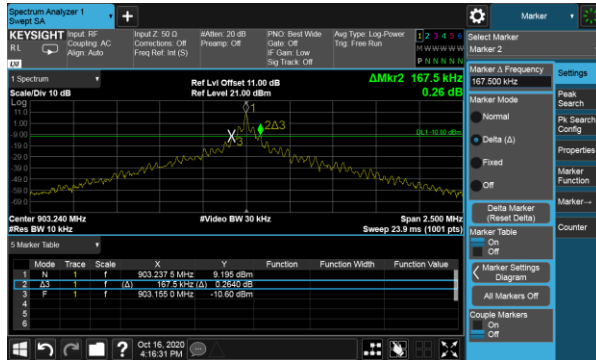

CH25

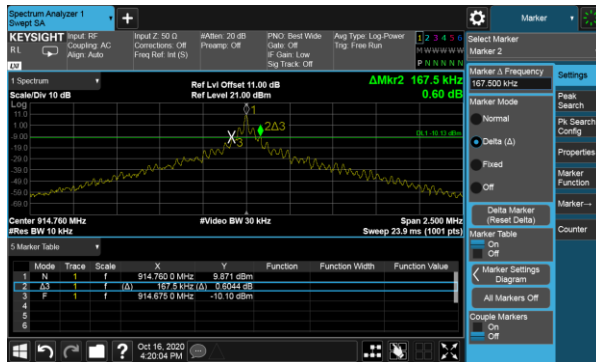

CH50

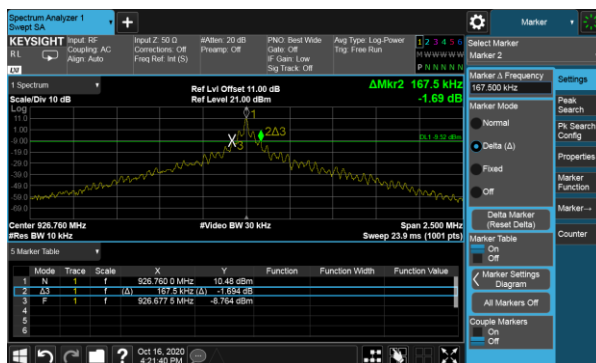



## 9. Frequencies Separation

### 9.1 Test Limit

Frequency hopping systems shall have hopping channel carrier frequencies separated by a minimum of 25 kHz or the 20 dB bandwidth of the hopping channel, whichever is greater.

### 9.2 Test Procedures

- a. The transmitter output was connected to the spectrum analyzer.
- b. Set RBW of spectrum analyzer to 10 KHz and VBW to 30 KHz.
- c. By using the MaxHold function record the separation of two adjacent channels.
- d. Measure the frequency difference of these two adjacent channels.

### 9.3 Test Setup Layout

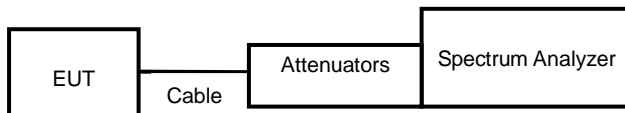

### 9.4 Test Result and Data

Modulation Type	Channel	Channel Frequency (MHz)	Channel Separation (MHz)	Limit (MHz)
ASK	1	903.24	0.48	0.1675
	25	914.76	0.48	0.1675
	50	926.76	0.48	0.1675



Modulation Type: ASK  
CH01

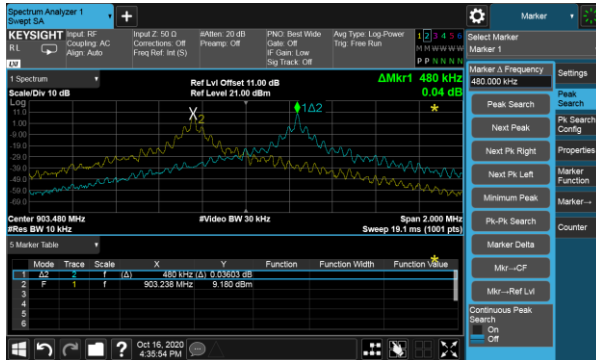

CH25

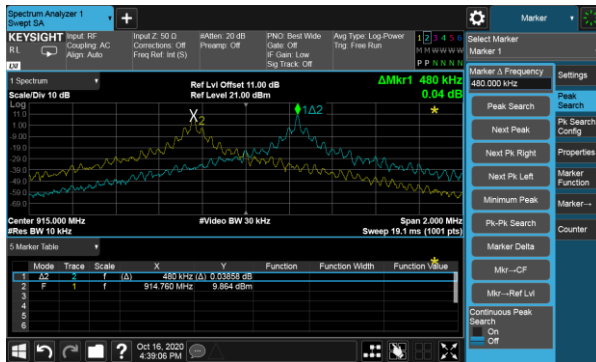

CH50

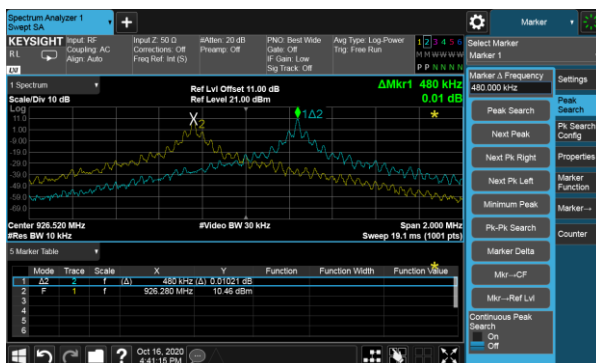



## 10. Dwell Time on each channel

### 10.1 Test Limit

The average time of occupancy on any channel shall not be greater than 0.4 seconds within a period of 0.4 seconds multiplied by the number of hopping channels employed.

### 10.2 Test Procedures

1. The transmitter output was connected to the spectrum analyzer.
2. Adjust the center frequency to measure frequency, then set zero span mode.
2. Set RBW of spectrum analyzer to 10 KHz and VBW to 30 KHz.
4. Measure the time duration of one transmission on the measured frequency.

### 10.3 Test Setup Layout

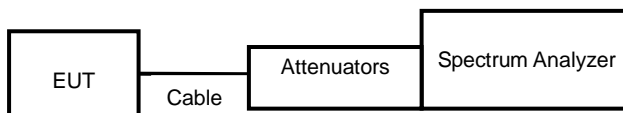

### 10.4 Test Result and Data

Channel	Channel Frequency (MHz)	Length of transmission time (ms)	Number of transmission in a 20 sec	Dwell Time (ms)	Limit (ms)
1	903.24	19.20	3.00	57.60	400
25	914.76	19.20	3.00	57.60	400
50	926.76	19.20	3.00	57.60	400



Modulation Type: ASK  
CH01

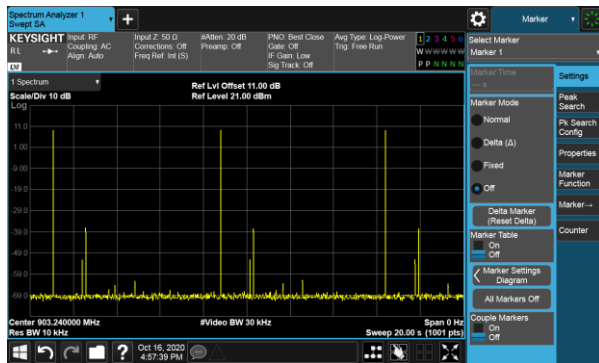

CH25

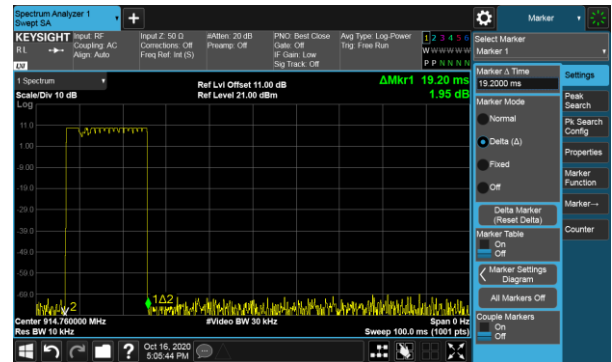
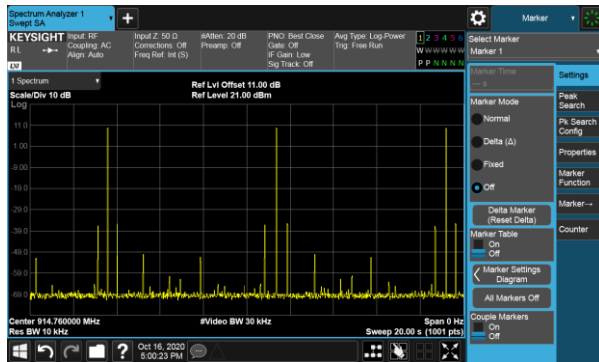

CH50

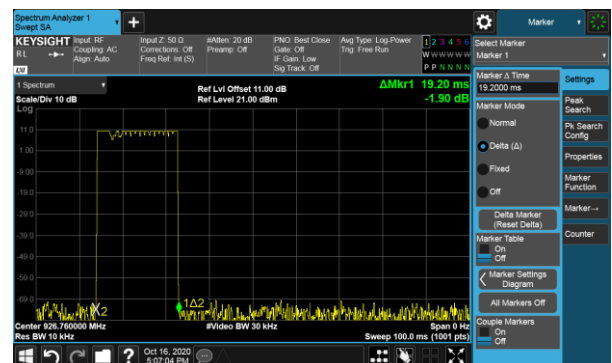
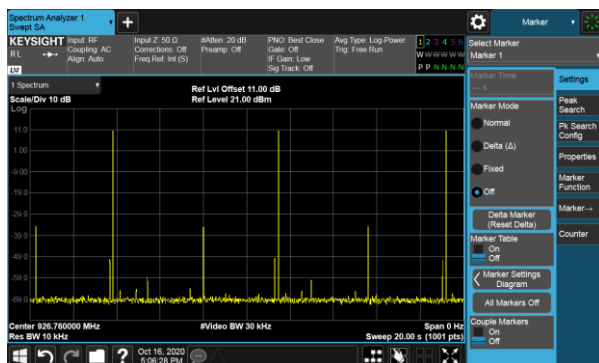



## 11. Number of Hopping Channels

### 11.1 Test Limit

Frequency hopping systems in the 902 ~ 928MHz band shall use at least 50 channels.

### 11.2 Test Procedures

- a. The transmitter output was connected to the spectrum analyzer.
- b. 2. Set RBW of spectrum analyzer to 10 KHz and VBW to 30 KHz.
- c. 3. Set the MaxHold function, and then keep the EUT in hopping mode. Record all the signals from each channel until each one has been record.

### 11.3 Test Setup Layout

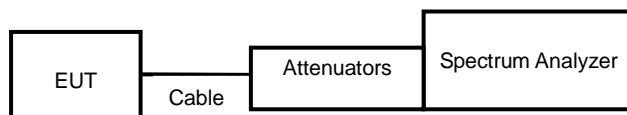

### 11.4 Test Result and Data

Modulation Type	Hopping Channels
ASK	50





Modulation Type: ASK

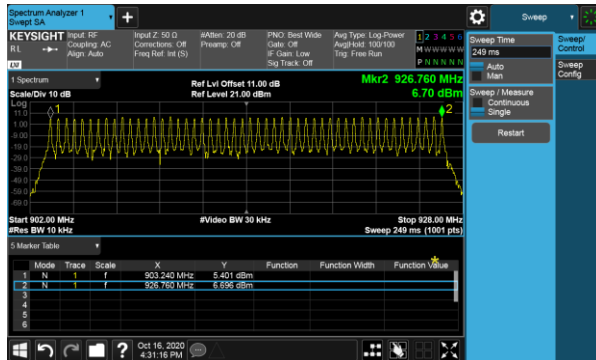



## 12. Maximum Peak Output Power

### 12.1 Test Limit

The Maximum Peak Output Power Measurement is 30dBm.

### 12.2 Test Procedures

The antenna port( RF output )of the EUT was connected to the input( RF input )of a power meter. Power was read directly from the meter and cable loss connection was added to the reading to obtain power at the EUT antenna terminal. The EUT Output Power was set to maximum to produce the worse case test result.

### 12.3 Test Setup Layout

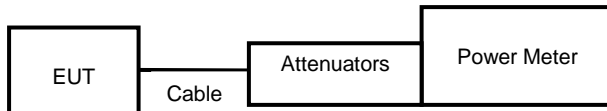



### 12.4 Test Result and Data

Modulation Type	Setting	Channel	Channel Frequency (MHz)	PK Output Power (dBm)	PK Output Power (mW)
ASK	10	1	903.24	8.82	7.621
	10	25	914.76	9.46	8.831
	10	50	926.76	<b>10.02</b>	10.046

Modulation Type	Setting	Channel	Channel Frequency (MHz)	AV Output Power (dBm)	AV Output Power (mW)
ASK	10	1	903.24	8.73	7.464
	10	25	914.76	9.36	8.630
	10	50	926.76	9.94	9.863

Note: Average power is for reference only.