



E-mail

support@vava.com

Manufacturer:

Manufacturer: Shenzhen Danya Technology Co.,Ltd.
Address: Room 2801,Building C,Galaxy World Phase ,Minle
Community,Minzhin Street,Longhua District,Shenzhen

Learn more about the EU Declaration of Conformity:

<https://www.vava.com/pages/user-manual>



CONTENTS

SAFETY INSTRUCTIONS	01
CAUTION	01
PACKAGE CONTENTS	02
PRODUCT DIAGRAM	03
GETTING STARTED	05
1. Charging & Powering Baby Monitor	05
2. Powering Camera	05
3. Pairing the Baby Monitor & the Camera	05
4. Placing the Camera	06
5. Wall Mounting Camera	06
6. Wide-Angle Lens (Optional)	07
FUNCTIONS & OPERATIONS	08
Monitor Interface Overview	08
1. Digital Zoom & Circulating	09
2. Pan-n-Tilt	10
3. Night Vision	10
4. Talkback	10
5. 5. Volume Adjustment	10
6. Display Brightness Adjustment	11
7. Camera	11
8. VOX	14
9. Alarm	15
10. Lullabies	15
11. Monitor Settings	15
SPECIFICATIONS	19
TROUBLESHOOTING	21
WARRANTY & CUSTOMER SERVICE	22
FCC STATEMENT	23
IC STATEMENT	25

SAFETY INSTRUCTIONS

- Keep cord out of the reach of children (more than 3ft / 0.9m away) in case of STRANGULATION.

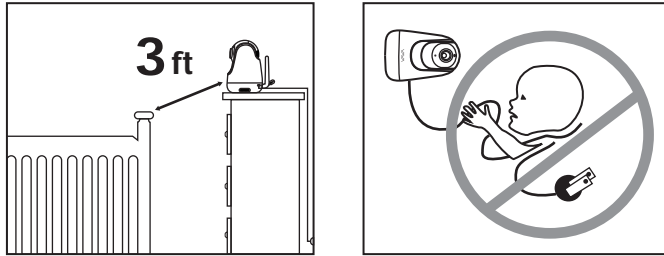

- NEVER place the camera or cord in or near the crib or playpen.
- NEVER mount the camera directly above the crib or playpen to avoid the risk of injury.
- Only use the AC adapters provided.
- Never use the unit near water, including near a bathtub, sink, laundry machine tube, wet basement, etc.
- Do not install near any heat sources such as radiators, heat registers, stoves, or other devices that produce heat.
- Only use attachments and accessories specified by the manufacturer.
- Unplug this device when unused for long periods of time.
- Do not insert anything into the upgrade pinholes. This operation is only intended for professionals.

CAUTION

- NOT toys. Do not allow children to play with them.
- The lens and lens hood are small parts, keep them out of your baby's reach at all times.
- This product is NOT intended to replace the proper supervision of children. You MUST check your child's activity regularly.
- This product is not intended for use as a medical camera and its use should not replace adult supervision.
- Unplug the product during lightning storms.
- Please check the operating range and condition of the camera carefully at

- the initial installation, and on a regular basis after that.
- Check the reception regularly. Test the camera before use and after changing the camera's location.
- For indoor use only.
- Clean the camera with a dry cloth only.
- Do not block any ventilation openings.
- Microphone feedback might occur when the monitor is too close to the camera. Please keep them at least 1.5m / 4.9ft apart.

PACKAGE CONTENTS

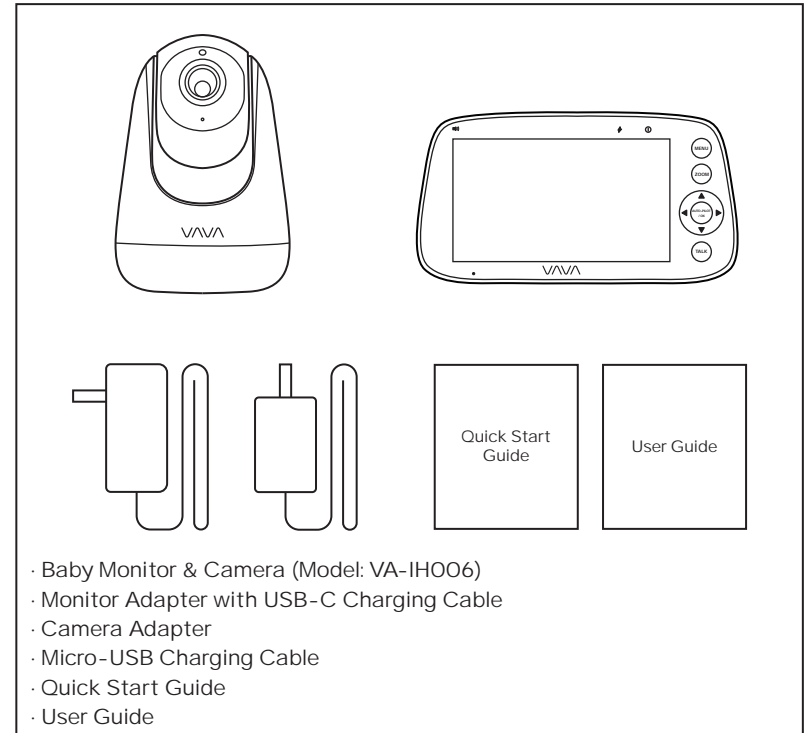

PRODUCT DIAGRAM

Baby Monitor

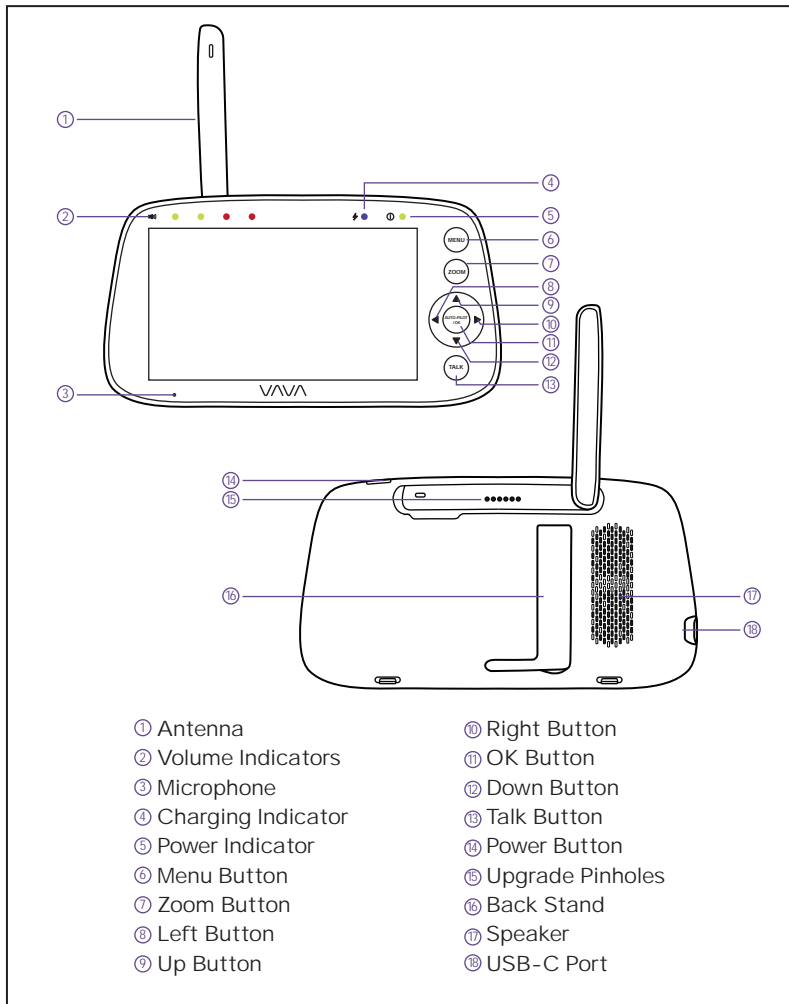

Camera

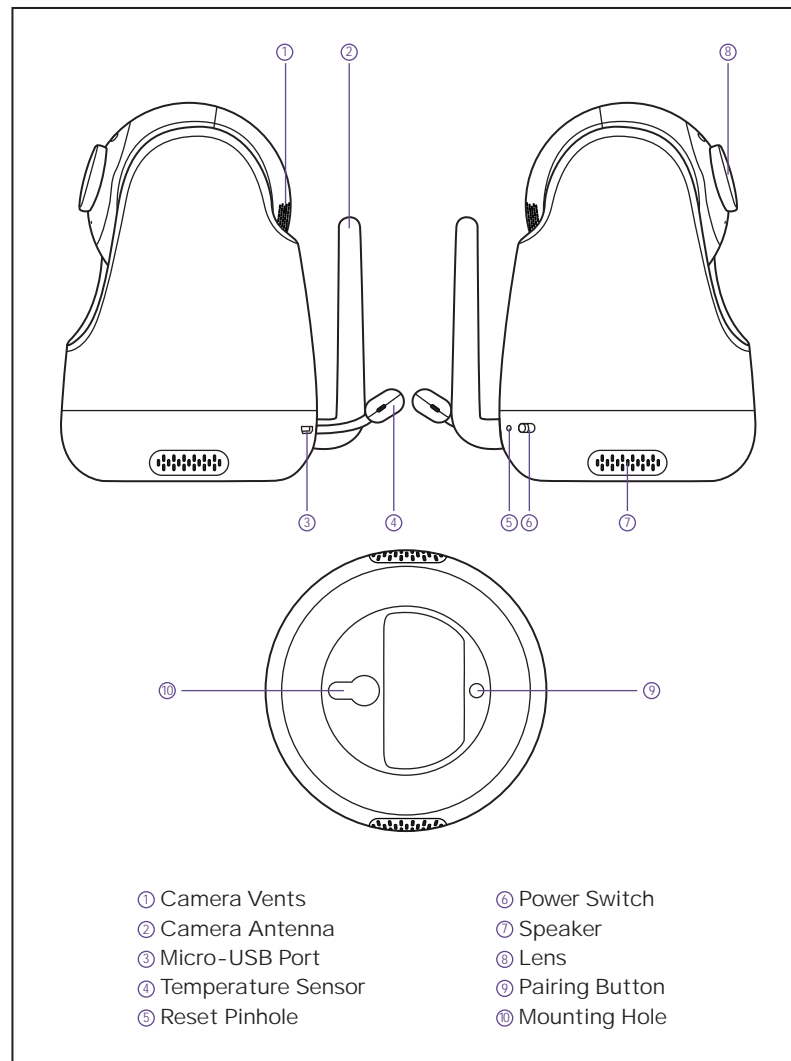

GETTING STARTED

1. Charging & Powering Baby Monitor

- 1) Connect the monitor adapter to the monitor and a power outlet.
- 2) Unplug the unit when its power indicator turns off, indicating a full charge.
- 3) Press the Power button on the monitor to power on with the power indicator lighting green.

2. Powering Camera

- 1) Connect the camera to power source via the Micro-USB cable and camera adapter.
- 2) Slide the Power Switch on camera to power on. Make sure the power indicator light is green.



- Only use the power adapters included in the package.
- Do not place the camera and power cord within the reach of your baby.

3. Pairing the Baby Monitor & the Camera

By default, one camera has been paired with the monitor when manufactured. When you power on the monitor and camera, the two will automatically pair. To add more cameras, press the Pair Button at the bottom of the camera, press Menu button, select through -> -> , and then the monitor will auto-pair with the camera.



- Once they're paired successfully, the camera number with icon 1 will be shown at the top left.
- Microphone feedback might occur when the monitor is too close to the camera. Please keep them at least 1.5m / 4.9ft apart.
- It is recommended to pair in the baby's room, or wherever you intend to place the camera.

4. Placing the Camera

Place the camera 1.5-2m / 4.9-6.6ft away from your baby for safety reason and for a better view when in night vision mode.

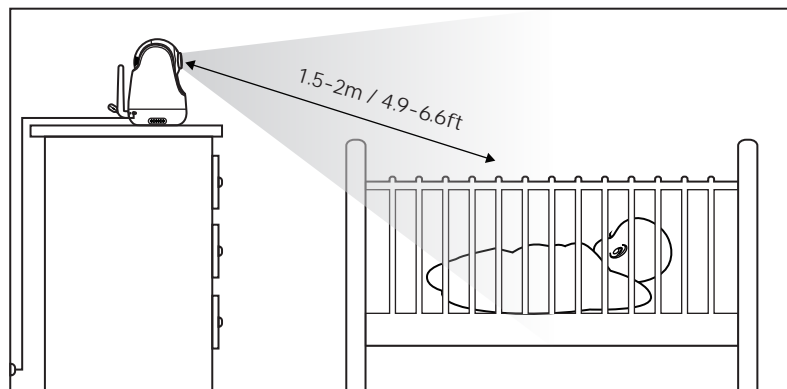

5. Wall Mounting Camera

- 1) Select the spot to mount the camera, keeping it beyond your baby's reach.
- 2) Insert the screw (not included) pre-installed on wall into the mounting hole of the camera.

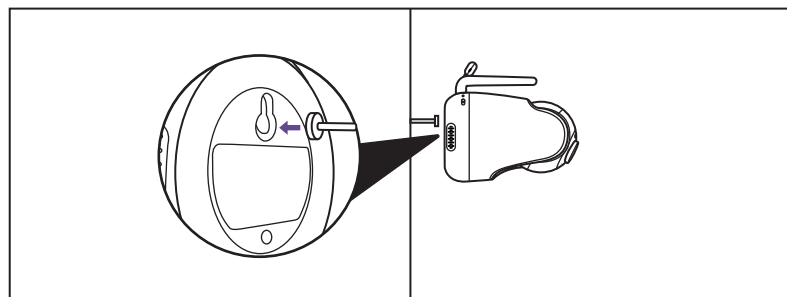

It's strongly recommended to use a screw and screw anchor. Don't release the camera until you're sure it is firmly mounted.

6. Wide-Angle Lens (Optional)

The aluminum lens hood (no special video effects) has been installed when the camera was manufactured.

To install wide-angle lens (sold separately), simply rotate the original lens hood counterclockwise to remove. Then install the new lens and rotate clockwise to fix in place.

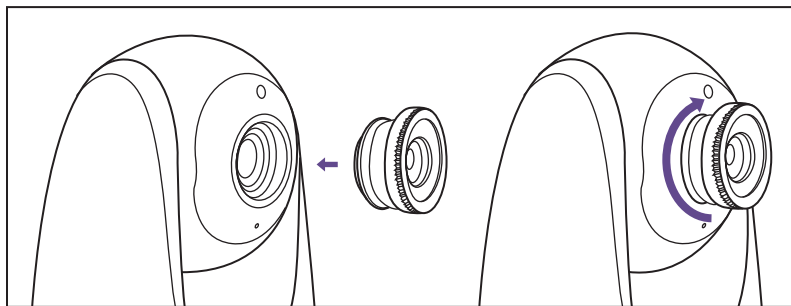
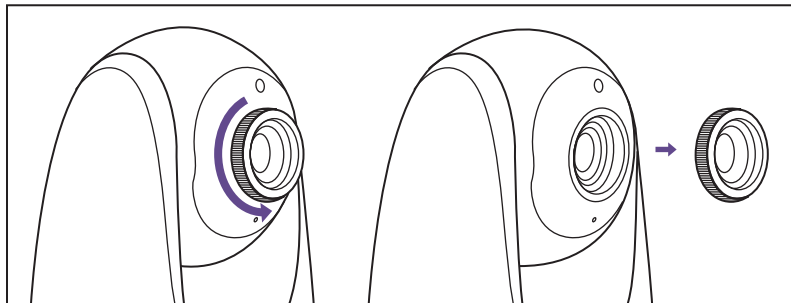

Install your wide-angle lens (separately sold) referring to the previous mounting wide-angle lens section. Now you can view the camera in a wider angle of about 170 degrees.

FUNCTIONS & OPERATIONS



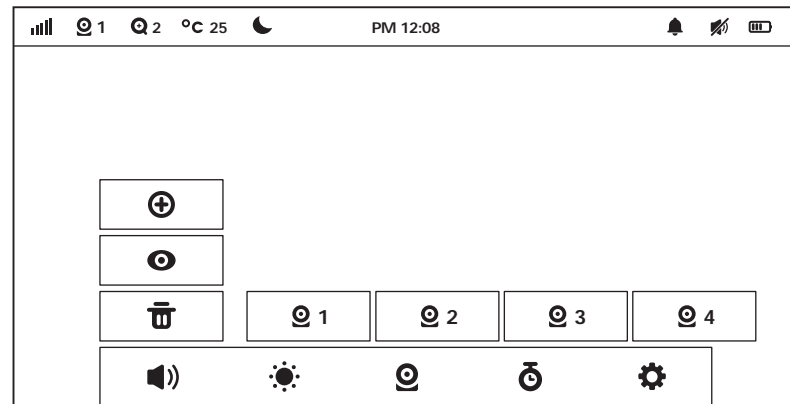











Monitor Interface Overview



Top Status Indications

	Signal	4 levels
	Current Camera	Camera 1 / Camera 2 / Camera 3 / Camera 4
	Zoom	2X / 4X
	Current Temperature	°C / °F
	Night Vision	Auto ON in a dim environment
	Current Time	AM / PM
	Alarm	ON / OFF
	Mute	Mute all system sounds
	Talk-back	ON / OFF
	Battery	5 levels
	Voice	Voice transfer between 2 cameras

Bottom Menu Brief

	Add Camera	Max. 4 cameras
	Split Screen	Select the cameras for split screen display
	View Camera	Select to view each at a time
	Delete Camera	Select to delete cameras
	Speaker Volume	0-7 levels (mute when it's 0)
	Brightness	1-8 levels
	Camera	To add / view / delete cameras
	Alarm	OFF / 2Hr / 4Hr /6Hr / Set Time (hour / minute / AM, PM)
	Settings	<ul style="list-style-type: none">  Time  System sound volume  Temperature scale  Auto-sleep time  Restore to factory setting  Customer service contacts

1. Digital Zoom & Circulating

- 1) Under split screen mode, press Left / Right Button -> OK Button to select the camera (Camera 1 or 2) you want to view or zoom in.
- 2) Press Zoom Button to zoom in to 2X / 4X when viewing the camera. A third pressing of the button will restore to the original image.
- 3) Press and hold OK Button for 4 seconds to start auto circulating 2 cameras simultaneously, press OK again to stop. Then press Menu Button to return to split screen display.



- The current zoom level number will be shown with the Zoom icon  2 on the monitor.
- Under split screen mode, you can select only one camera to zoom in.

2. Pan-n-Tilt

When viewing the camera, press Left / Right / Up / Down Button to view at different angles, 108 degrees vertically and 270 degrees horizontally.

3. Night Vision

The night vision is automatically activated in a dim environment. The camera has 12 high-intensity infrared LEDs for picking up clear images in the dark. Black and white images can be captured within 2m distance.

4. Talkback

- 1) Press Talk / Shortcut Button once to quickly adjust the Volume or Brightness.
- 2) Talking Under Split Screen Mode:
 - Press Left / Right Button to select the camera (Camera 1 or 2) you want to talk to. Hold to talk and release to exit.



- When you enter the talking mode, the icon  will be shown on the monitor.
- When it's mute or the speaker volume is too low, you may not be able to hear the baby.
- When you're pressing the Talk Button, the camera will not transfer the sound to the monitor. Please release the button to listen to your baby.

5. Volume Adjustment



- 1) Use Shortcut Button: Press Talk Button -> Left / Right Button to quickly adjust the volume with  &  icons.

- 2) Or you can press Menu Button: Choose  -> OK Button -> Left / Right Button to volume down / up, and OK Button to saving your settings.



For system sound adjustment, please go to Monitor Settings ->  System sound volume.

6. Display Brightness Adjustment

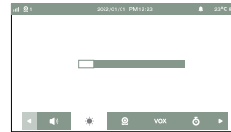

- 1) Use Shortcut Button: Press Talk Button -> Up / Down Button to quickly adjust the brightness with  &  icons.

- 2) Or you can press Menu Button: Choose  -> OK Button -> Up / Down Button to turn up / down the brightness, and OK Button to saving your settings.



7. Camera

Add Camera

- 1) Press Menu button, select through  ->  ->  to add a camera.





- 2) Press and hold the Pair Button on the camera for 3 seconds



Four Cameras at most can be connected to one monitor.

Split Screen

- 1) Press Menu button, select through  ->  .
2) Then select two cameras (Camera 1/2/3/4) for  Split screen display.

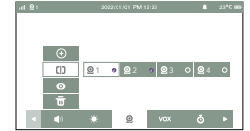

- 3) Once set, you can view two cameras at one time without delay. The sound of the two rooms will be switched every 15 seconds.

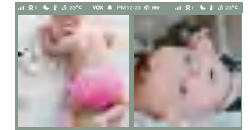



- 4) Under Split screen mode, you can also press Left / Right Button -> OK Button to select one camera (Camera 1 or 2) you want to view or zoom in. Press the Menu Button to return to Split screen mode.



The split screen mode it turned on by default when the monitor is powered on.

View Camera

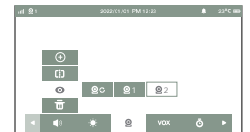

- 1) Press Menu button, select through  ->  to view a camera.
- If there are 2 or more cameras, tap  to cycle through the added cameras every 15 seconds.
 - Select the camera number (1/2/3/4) to view the corresponding camera.





You can switch viewing different cameras; the current camera number will be shown with the Camera icon  on the monitor.

DeleteCamera

- 1) Press Menu button, select through  ->  to delete a camera.

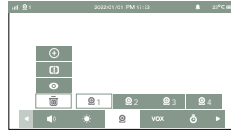

At least one camera shall be added. Do not delete all the cameras. If necessary, please add a new camera before deletion.

8. VOX

- 1) Explanation:
 - There are three options of sound detection, LOW(78dB), MEDIUM(65dB) and HIGH(60dB). LOW means the sound can be detected if it reached 78dB, and so on for MEDIUM and HIGH.
 - Setting " off " turns off the alarm sound in VOX mode.

- 2) Press Menu button, Choose **VOX** -> OK Button.



- 3) Select the option you want. Press OK Button.

9. Alarm

- 1) Explanation: This function is to remind you of feeding your baby. OFF means you shut down the function; 2 hour means it reminds you every 2 hours and so on for the other options.

- 2) Press Menu button, Choose  -> OK Button.



- 3) Select the time you want. or set the hour and minute otherwise. When the alarm time is reached, a beep will be heard. Press OK Button to stop; otherwise it'll keep beeping for 30s, beeping again in 1min, stops after it's alerted 3 times. .





- When the timer is set, the Alarm icon  will be shown on the monitor.
- Before setting, please check that the monitor time is your current time.

10. Lullabies

- 1) Explanation: This function is to comfort baby when needed.

- 2) Press Menu button, Choose  -> OK Button.

- 2) Select the lullaby you want. Select   to play the lullabies in a loop.



Left / Right Button to volume down / up, and OK Button to saving your settings .

11. Monitor Settings

Explanation: This is the sub-menu of the function page where the temperature alert icon, auto sleep time, System sound volume, date and time, system language, Customer service contacts and Restore to factory setting.



- 1) Press Menu button, Choose

 -> OK Button.

- 2) Select the function to be adjusted.



Temperature Alert

Explanation: The monitor will prompt too high (>35°C / 95°F) and too low (<0°C / 32°F) temperatures with the "HH" and "LL" icon, accompanied with a  &  icon and a beep alert.

- 1) Choose  -> OK Button.

- 2) Select between °C and °F.
Press OK Button.



When the monitor is mute, you may not be able to hear the baby.

Screen auto-sleep time

- 1) Choose  -> OK Button .

- 2) Select between 1min, 2min, 5min, and OFF.
Press OK Button.



- When the monitor screen is under sleep mode, the power indicator flashes green slowly while the audio is still on; press any button to awake. You can also short press the Power Button to turn the screen off.
- Press and hold the Power Button to power on / off the monitor.

System sound volume

This function is to adjust the monitor side system sound.

- 1) Choose  -> OK Button .

- 2) Select between Low, High, and Mute.
Press OK Button.



- To mute the sound during poor monitor-camera connection, please set the  system sound volume to mute.

Date

1) Choose  -> OK Button .

2) Set the current date by setting the year, month and day.
Press OK Button.



Time

1) Choose  -> OK Button .

2) Set the current time by setting hour, minute, and AM/ PM.
Press OK Button.



Language

There are four languages built in your device, you can choose your language here.

1) Choose  -> OK Button .

2) Select your language.
Press OK Button.



· If you need to return to the video page, please press twice Menu button or wait 30 seconds to return.

Customer service contacts

1) Choose  -> OK Button .

2) Check the email, Tel. number, and address for customer service.
Press OK Button.



· If you need to return to the video page, please press twice Menu button or wait 30 seconds to return.

Restore to factory

1) Choose  -> OK Button .

2) Conform YES to reset. Press Menu button or conform NO to exit.



Press OK Button to confirm resetting; "Restoring factory settings" will be shown when restoring, and you can't press any button to control the device during this period. The monitor will auto restart when it's done.

SPECIFICATIONS



Monitor

Model	VA-IH009
Resolution	IPS (720 x 1280), PPI=296
Connectivity	2.4GHz
Image Aspect	16:9 (HD720)
Image Compression	h.264 (frame rate = 18fs)
Operating Range	280 - 300m (antenna vertically positioned at 90°)
Temperature Alert	Yes
Volume Control	7 levels
Brightness	8 levels
Antenna	Rotatable (max. 90 degree)
Power Input	5V / 2A (1.5m long USB C cable)
Zoom	Zoom In (2X) Zoom In (4X)
Auto-Pilot	2 cycles
Two-Way Talk	Yes
Multi-Camera	Max. 4 cameras
Storage Temperature	-10°C ~ 55°C / 14°F - 131°F
Operation Temperature	0°C ~ 40°C / 32°F - 104°F

Camera

Cmos	720p(1280x720), 1.0M, 1/4"
Connectivity	2.4GHz
Image Compression	h.264 (frame rate = 18fs)
Power Input	5V / 2A, 2m-long Micro-USB cable
Pan-n-Tilt	108 degrees vertical (Up=90, Down=18) 270 degrees horizontal (Left=135, Right=135)
Zoom	Zoom In (2X) Zoom In (4X)
Auto-Pilot	2 cycles
View Angle	Vertical: 1.5m, Horizontal: 1.4m
Depth of Field	1.5m to 6m
Night Vision	Black & White image, 2m clear range, up to 6m
IR LED	Non-visible IR LED with wavelength 940nm (x 12 pcs)
Light Sensor	Yes
Two-Way Talk	Yes
Storage Temperature	-10°C ~ 55°C / 14°F - 131°F
Operation Temperature	0°C ~ 40°C / 32°F - 104 °F

TROUBLESHOOTING

Product not powering on?	<ul style="list-style-type: none"> · Check that the camera and monitor are turned on. · Check the camera is connected to power properly (it cannot be charged; it's power off once disconnected from power). · Check that the monitor is of enough battery (it'll auto shut off when battery level icon flashes red slowly on the monitor). · Check the intactness of the power cable.
Baby monitor can't connect with the camera?	<ul style="list-style-type: none"> · Check whether the camera is near the monitor (recommended to keep within 1.5-2m / 4.9-6.6ft). · Check whether the monitor is of low battery. Charge it in time to restore good connection. · Check whether the camera is well connected to power. · Check whether there are any large metallic objects including doors, refrigerators, mirrors, etc., are placed between the camera and monitor thus blocking the radio signals. · Check whether there's any other 2.4GHz product is used nearby like WiFi routers, microwave ovens, which may interfere the connection. · If nothing above is involved, please retry to pair: press the Pair Button at the bottom of the camera, press Menu button, select through  ->  ->  , and then the monitor will auto-pair with the camera.
Nothing shown when I view a camera?	<ul style="list-style-type: none"> · Check all connections to the camera (power cable plugging and pairing). · Check whether the screen is in sleep mode. Press any button to awake it. · Check whether the camera is within range of the monitor. · Adjust the monitor antenna to vertical position for

No sound from the monitor?	<p>better signal transfer. Check whether the system sound volume is set to "0". It'll be mute if set so.</p>
Black and white pictures?	<p>Night vision LED may be ON. Please turn on room lights to force it out of the night mode.</p>
Choppy videos?	<ul style="list-style-type: none"> · Check whether the camera is near the monitor and that there're no obstacles between them. · Adjust the monitor antenna to vertical position for better signal transfer.
Too much noise?	<ul style="list-style-type: none"> · Volume may be set too high. Press Menu Button -> OK Button -> Left Button to volume down. · The camera and monitor may be put too close; keep them at least 1.5m / 4.9ft apart. · The camera may be too out of range. Please keep it within 10m / 32.8ft to the monitor.
Software Version?	<p>Press the Power button on the monitor to turn off the monitor. The software version will be displayed at the screen bottom before power off.</p>

WARRANTY & CUSTOMER SERVICE

12 months warranty

Lifetime customer service (contacts on the monitor, and back cover of this User Guide)

FCC STATEMENT

changes or modifications not expressly approved by the party responsible for compliance could void the user's authority to operate the equipment.

This device complies with Part 15 of the FCC Rules. Operation is subject to the following two conditions:

- (1) this device may not cause harmful interference, and
- (2) this device must accept any interference received, including interference that may cause undesired operation.

Note: This equipment has been tested and found to comply with the limits for a Class B digital device, pursuant to Part 15 of the FCC Rules. These limits are designed to provide reasonable protection against harmful interference in a residential installation. This equipment generates, uses, and can radiate radio frequency energy, and if not installed and used in accordance with the instructions, may cause harmful interference to radio communications. However, there is no guarantee that interference will not occur in a particular installation. If this equipment does cause harmful interference to radio or television reception, which can be determined by turning the equipment off and on, the user is encouraged to try to correct the interference by one or more of the following measures:

- Reorient or relocate the receiving antenna.
- Increase the separation between the equipment and receiver.
- Connect the equipment into an outlet on a circuit different from that to which the receiver is connected.
- Consult the dealer or an experienced radio/TV technician for help.

FCC RF Exposure Statement (for Camera)

This equipment complies with FCC radiation exposure limits set forth for an uncontrolled environment. This equipment should be installed and operated with a minimum distance of 20cm between the radiator & your body. This transmitter must not be co-located or operating in conjunction with any other antenna or transmitter.

IC STATEMENT

This device contains licence-exempt transmitter(s)/receiver(s) that comply with Innovation, Science and Economic Development Canada's licence-exempt RSS(s). Operation is subject to the following two conditions:

- (1) This device may not cause interference.
- (2) This device must accept any interference, including interference that may cause undesired operation of the device.

L'émetteur/récepteur exempt de licence contenu dans le présent appareil est conforme aux CNR d'Innovation, Sciences et Développement économique Canada applicables aux appareils radio exempts de licence. L'exploitation est autorisée aux deux conditions suivantes :

- 1) L'appareil ne doit pas produire de brouillage;
- 2) L'appareil doit accepter tout brouillage radioélectrique subi, même si le brouillage est susceptible d'en compromettre le fonctionnement.

The device meets the exemption from the routine evaluation limits in section 2.5 of RSS 102 and compliance with RSS-102 RF exposure, users can obtain Canadian information on RF exposure and compliance.

Le dispositif rencontre l'exemption des limites courantes d'évaluation dans la section 2.5 de RSS 102 et la conformité à l'exposition de RSS-102 rf, utilisateurs peut obtenir l'information canadienne sur l'exposition et la conformité de rf.

This transmitter must not be co-located or operating in conjunction with any other antenna or transmitter. This equipment should be installed and operated with a minimum distance of 20 centimeters between the radiator and your body.

Cet émetteur ne doit pas être Co-placé ou ne fonctionnant en même temps qu'aucune autre antenne ou émetteur. Cet équipement devrait être installé et actionné avec une distance minimum de 20 centimètres entre le radiateur et votre corps.