

The background of the page is white and features several decorative, flowing teal lines that create a sense of movement and modernity. These lines are smooth and organic in shape, curving across the page from top to bottom.

Baby Monitor 5.5"/5"屏

USER MANUAL

720P/1080P

→ **ENGLISH**

This device complies with part 15 of the FCC Rules. Operation is subject to the following two conditions:
(1) this device may not cause harmful interference, and
(2) this device must accept any interference received, including interference that may cause undesired operation.

WARNING

Incorrect use of the product(s) may lead to safety risks. Therefore, we STRONGLY recommend reading the following instructions before using your product.

1. Keep the cord(s) away from children in case of strangulation (3 feet/ 1 meter away).
2. Put the product(s) in a dry place in case of short-circuit.
3. Use the AC adapter(s) provided by us ONLY. Using unauthorized charging cables and AC adapters may result in overheat even explosion.
4. Unplug the AC adapter(s) if you don't use it(them).
5. Check your baby's activities regularly as this product is not designed for supervision but for assisting your supervising.

PACKING LIST

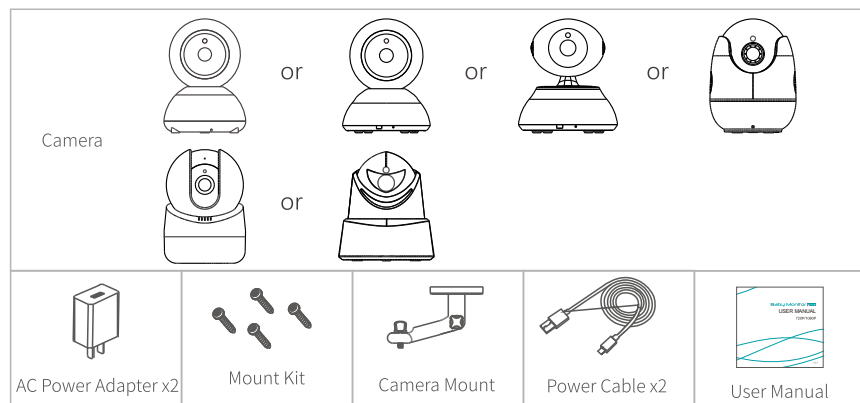
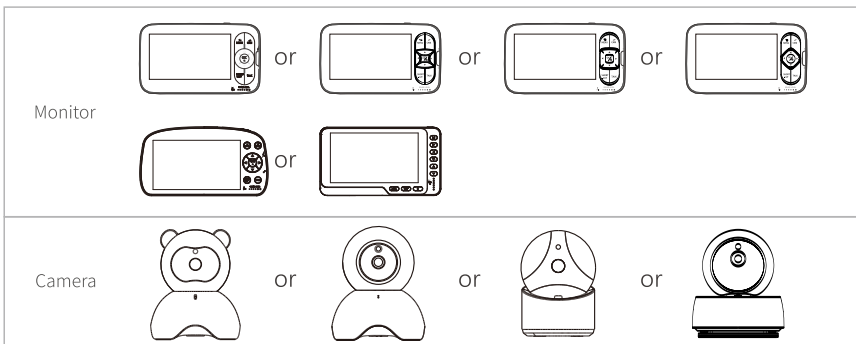

CAMERA

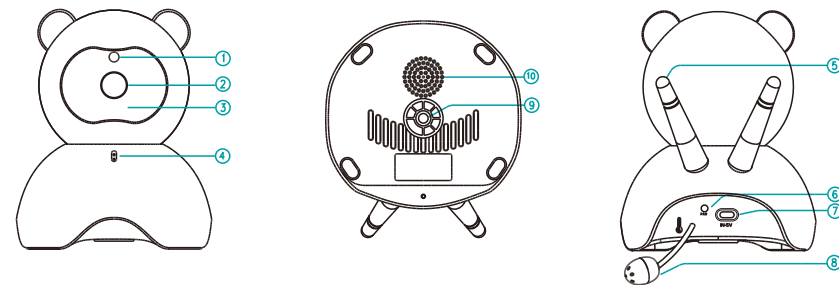

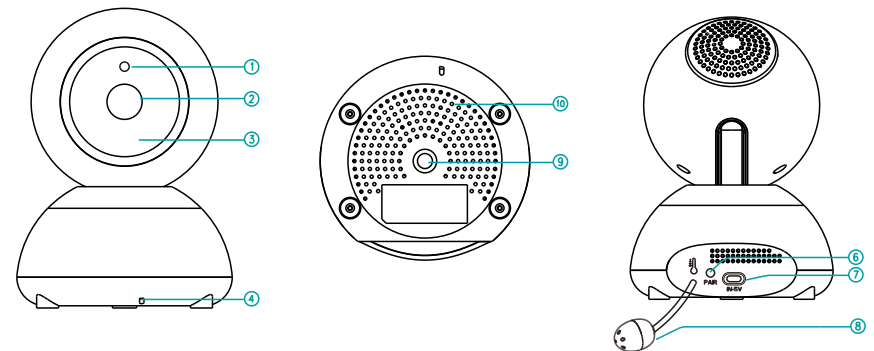
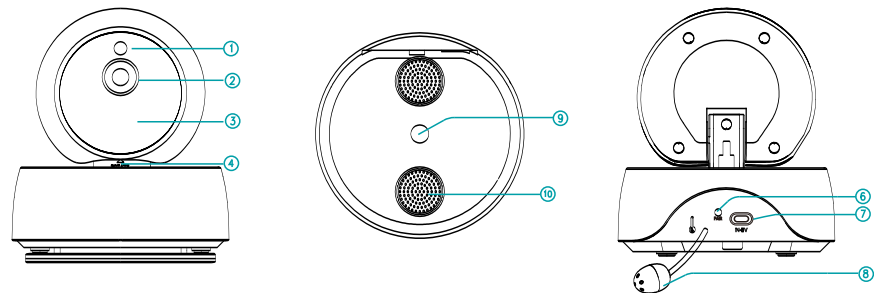
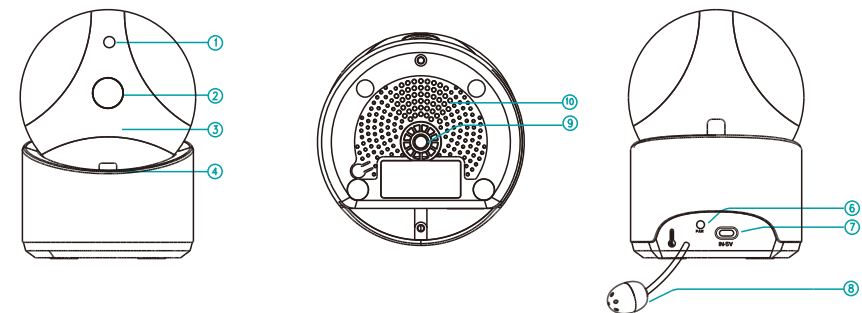
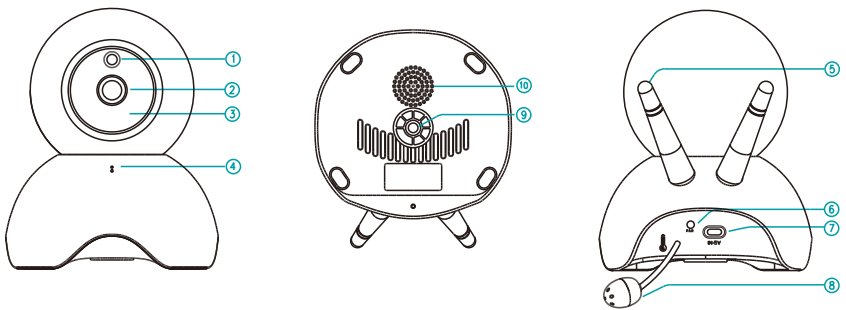

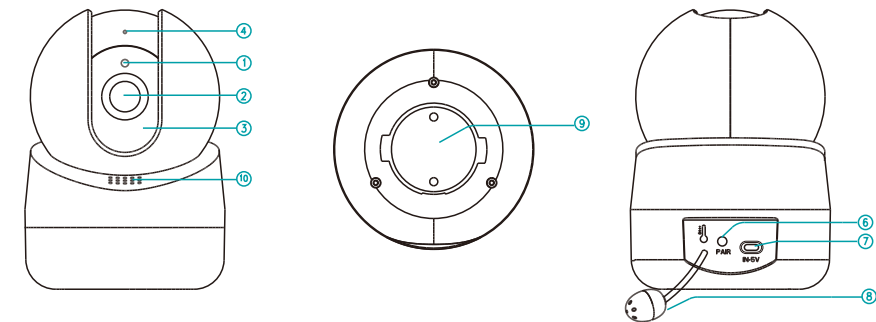
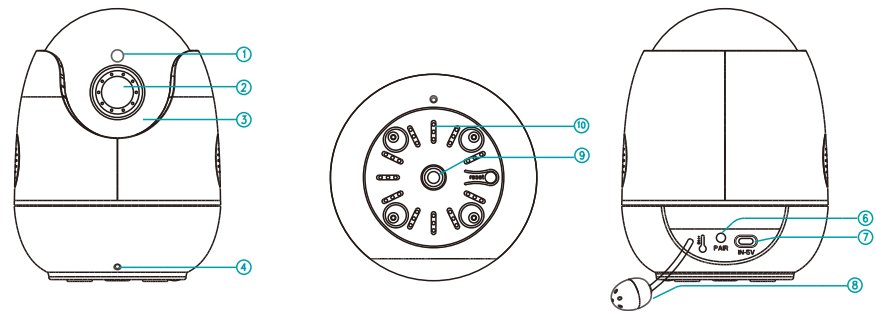
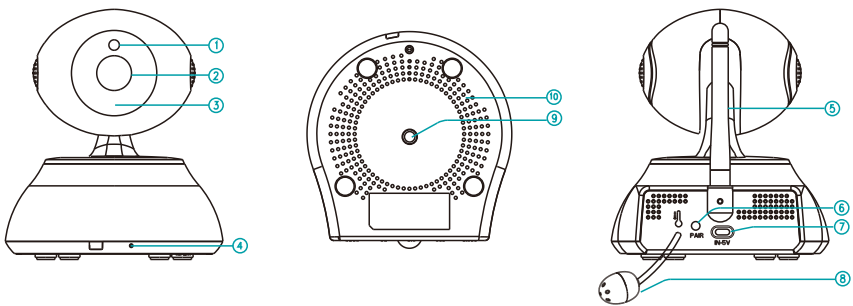
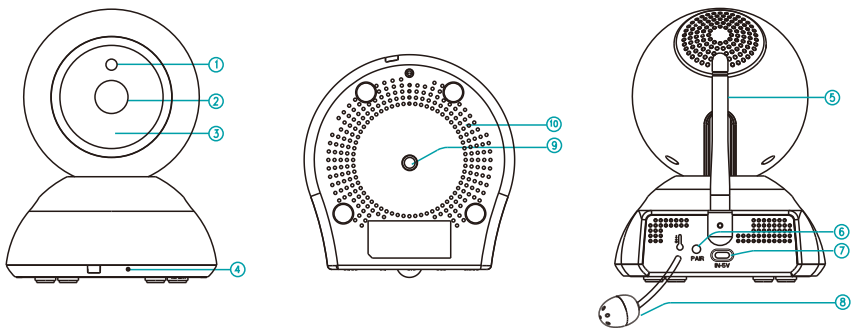

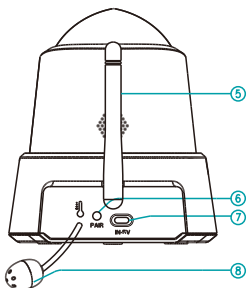
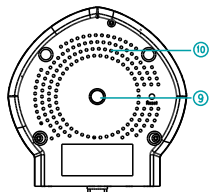
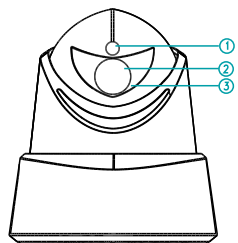

- 1. Night Vision Sensor
- 2. Camera Lens
- 3. IR LED
- 4. Microphone

- 5. Antenna
- 6. Pair Button
- 7. Power Input
- 8. Temperature Sensor

- 9. Mounting Bracket
- 10. Speaker

MONITOR

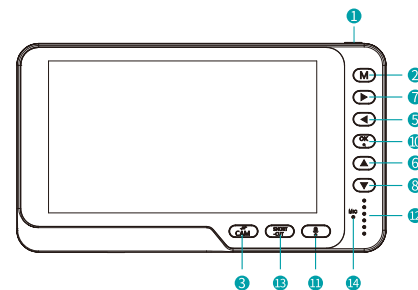
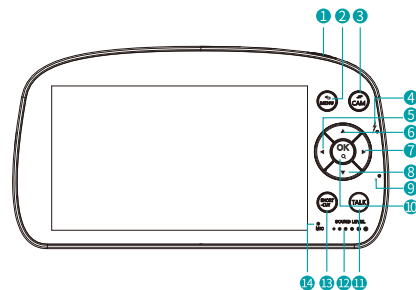
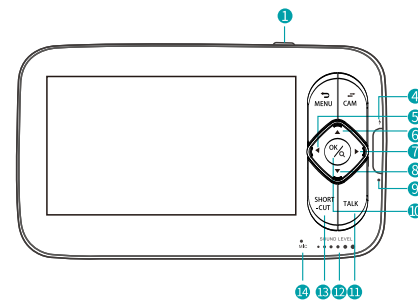
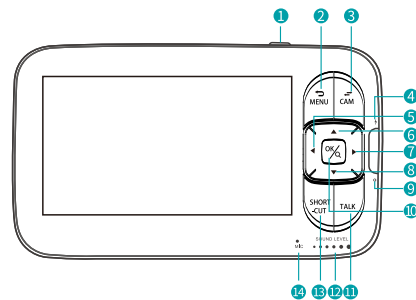
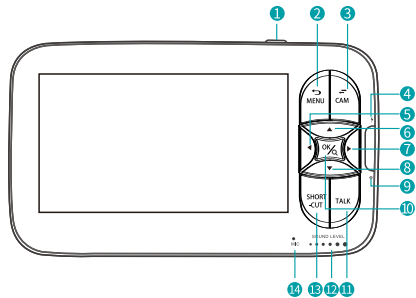
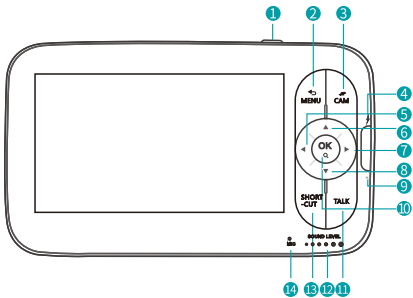

- Power/Sleep Button:** Long press to turn on/off the monitor; short press to turn on/off the screen.
- Menu/Back:** Press to enter menu page or press as a Back button.
- Camera Switch:** Switch cameras if connected with 2 or more cameras.
- Charging Indicator:** It gives off yellow light while the monitor is being charged.
- Left:** Press to pan the camera leftward or to change your selection leftward.
- Up:** Press to tilt the camera upward or to change your selection upward.
- Right:** Press to pan the camera rightward or to change your selection rightward.
- Down:** Press to tilt the camera downward or to change your selection downward.
- Power Indicator:** The green light turns on if connected to electricity.
- Zoom/OK:** Press to Zoom in/out or to confirm your selection.
- Talk:** Press to talk to your baby in the monitoring image.
- Sound Level LED:** Low/high level shows low/high sound detected by the camera.
- Volume/Brightness:** Press to adjust the monitor's volume or brightness in the monitoring image.
- Microphone**

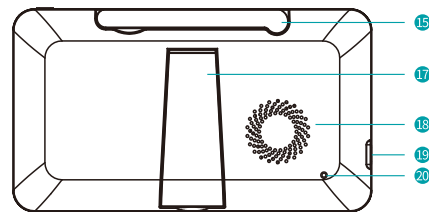
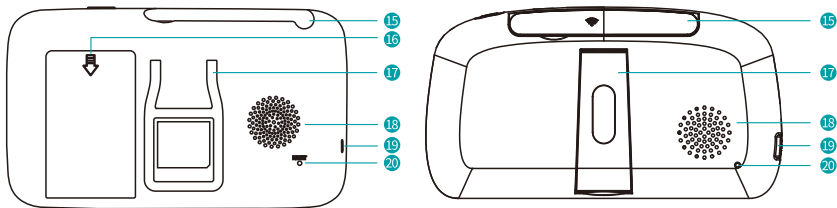

15. Antenna
16. Battery Compartment
17. Support Stand
18. Speaker
19. Power Input
20. Reset Hole

Note:

1. If you RESET with a pin, the monitor will be forced shutdown.
2. Do not open the battery compartment without official guidance.

GETTING STARTED

Step 1:

1. Connect the camera to the AC adapter.
2. Plug the AC adapter into a socket.

Note: Put the camera away from your baby (3ft/1m away at least).

Step 2:

1. Connect the monitor to the AC adapter.
2. Plug the AC adapter into a socket.
3. Long press the Power button to turn on the monitor then you can see the monitoring interface.

Note:

The monitor takes about 4 hours to be fully charged, and it lasts about 4-5 hours.

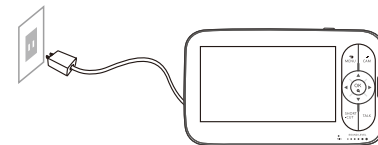



CAMERA SETTING

Notice:

The camera and monitor were paired already. This function is to add new cameras to the monitor.

1. Add cameras

Step 1:

1. Press  to enter menu page.
2. Choose  and press OK button.



Step 2:

1. Select  then press OK button.

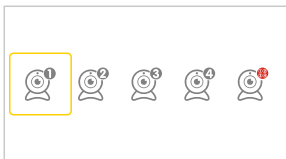

Step 3:

1. Select  and press OK button TWICE.
See Camera is NOT paired.
2. Press OK button to start pairing.

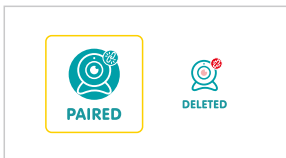

Step 4:

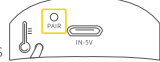
1. Press  PAIR button on the back of the camera.
2. Then see the prompted Paired.

Note: Four cameras at most can be connected to one monitor.

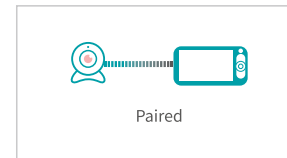

2. Delete cameras

Step 1:

1. Press  to enter menu page.
Choose  and press OK.

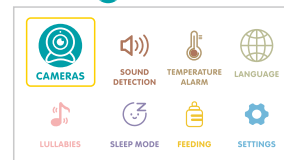

2. Select the camera need deleting.
Press OK.

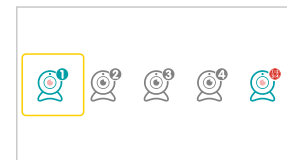

Step 2:

1. Select the right camera icon. Press OK TWICE.

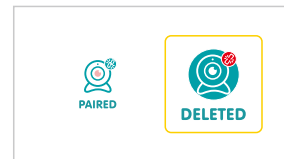

2. See Deleted. Your camera is deleted.

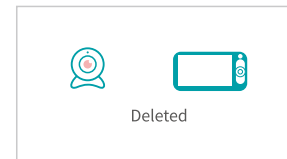

SOUND DETECTION

Explanation:

There are four options of sound detection, OFF, LOW (80dB), MEDIUM (70dB) and HIGH (65dB). OFF means you shut down the function; LOW means the sound can be detected if it reached 80dB, and so on for MEDIUM and HIGH.

Step 1:

1. Press to enter menu page. Choose and press OK.



2. Select the option you want. Press OK.

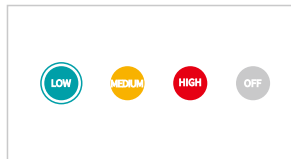

TEMPERATURE ALARM

Explanation:

This function is to send alarms if the temperature is too low (< 15°C/59°F) or too high (> 29°C/84°F).

Step 1:

1. Press to enter menu page. Choose and press OK.

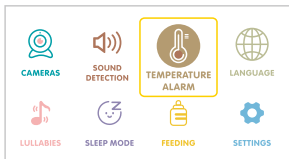

2. Select the option you want. Press OK.

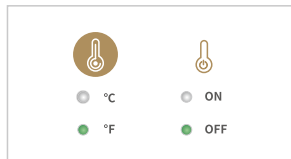

Note: A sound/temperature alarm can be temporarily turned off by pressing any button on the monitor.

LANGUAGE

Explanation:

There are eight languages built in our device, you can choose your language here.

Step 1:

1. Press to enter menu page. Choose and press OK.

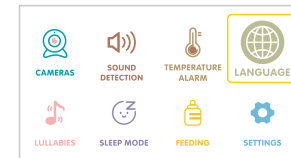

2. Select your language and press OK to confirm.

LULLABIES

Explanation:

This function is to comfort your baby when needed.

Step 1:

1. Press to enter menu page. Choose and press OK.

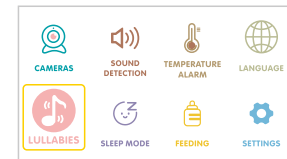

2. Select the lullaby you want. Select ALL to play the lullabies in a loop.

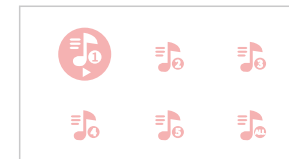

SLEEP MODE

Explanation:

This function is to prolong your monitor's runtime by shutting down the screen.

Step 1:

1. Press **MENU** to enter menu page.
Choose  and press **OK**.

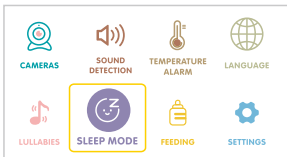

2. Select the time you want.
Select **OFF** to turn off Sleep Mode.

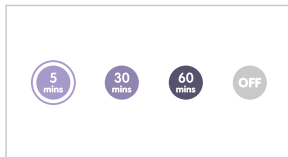

Note: The screen will automatically light up if there is a sound alarm or a temperature alarm.

FEEDING

Explanation:

This function is to remind you of feeding your baby. **OFF** means you shut down the function; **2.5 hour** means it reminds you every 2.5 hours and so on for the other options.

Step 1:

1. Press **MENU** to enter menu page.
Choose  and press **OK**.

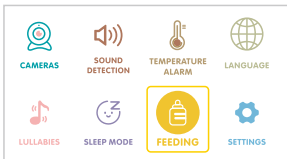

2. Select the time you want.
Select **OFF** to turn off the feeding reminder.



SETTINGS

Explanation:

This function is to set Date/Time, turn on/off OSD, restore factory settings and provide service support information.

Date/Time:

1. Press **MENU** to enter menu page.
Choose  and press **OK**.

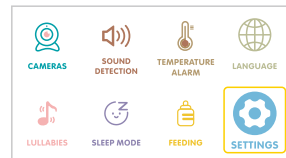

2. Select **Date/Time**.
Press **OK** to enter the interface.

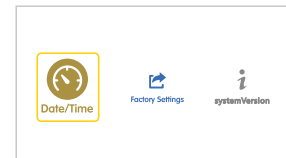

3. Press **OK** to start/finish setting.
 stands for starting the setting.

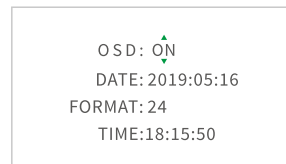

4.  stands for finishing the setting.



Note:

* Press Up/Down/Left/Right to select and press OK button to confirm.

* If OSD is ON, the date and time will be displayed on the status bar of the monitor; otherwise, it will not be displayed.

Restore factory settings:

1. Select and conform 

Press OK to enter the interface.

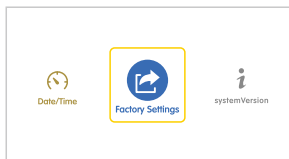

2. Conform YES to reset.

Press  or conform NO to exit.

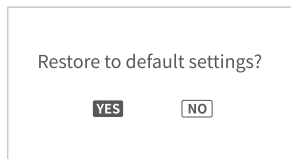





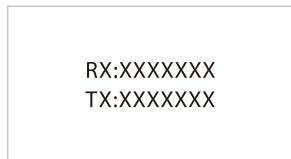
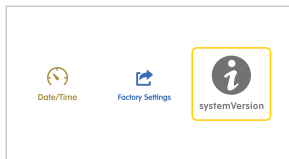



1. Select .

Press OK to enter the interface.







ICONS EXPLANATION



1. Status Bar Icons

-  : No signal connection
-  : Signal strength
-  : Live video loop
-  : Lullabies enabled
-  : Sleep Mode enabled
- 27°C : Current room temperature
-  : Battery Level
-  : Sound detection enabled
-  : Temperature alarm enabled
-  : Feeding reminder enabled

2. Notifications Icons

-  : No camera connected
-  : Sound Alarm
-  : Temperature Alarm
-  : Feeding Notification

Explanation:

You can open Live-Video-Loop function through short presses on the  button until you see  on the status bar. When Live-Video-Loop function is on, the connected cameras will automatically switch every 10 seconds. And if there is a sound/temperature alarm, the camera-switch function will pause temporarily.

FAQ

Q1. Why did I fail to connect the camera to the monitor?

- * Make sure to plug the power adapter into the camera and socket firmly.
- * Make sure the camera and the monitor is within the effective distance.

Q2. Why is the live video so blurry?

- * Make sure there is no obstacle on the lens of the camera.

Q3. Why did the monitor make noise?

- * The camera and monitor may be too close. Put them further apart.

Q4. Can I hear my baby when I turn off the screen?

- * Yes. You should turn on Sound Detection, and it will wake up the screen and make a sound alarm if a loud sound is detected.

Q5. Why is the picture black and white?

- * The Night Vision Mode will be activated if the camera worked in a dark environment (Brightness \leq 5 Lux).

Q6. How long will the monitor stand by with 5" screen on?

- * The monitor can last about 5 hours, and the time of endurance varies depending on the brightness.

Q7. How long will the monitor stand by with 5.5" screen on?

- * The monitor can last about 10 hours, and the time of endurance varies depending on the brightness.

FCC Caution:

This device complies with part 15 of the FCC Rules. Operation is subject to the following two conditions: (1) This device may not cause harmful interference, and (2) this device must accept any interference received, including interference that may cause undesired operation.

Any Changes or modifications not expressly approved by the party responsible for compliance could void the user's authority to operate the equipment.

Note: This equipment has been tested and found to comply with the limits for a Class B digital device, pursuant to part 15 of the FCC Rules. These limits are designed to provide reasonable protection against harmful interference in a residential installation. This equipment generates uses and can radiate radio frequency energy and, if not installed and used in accordance with the instructions, may cause harmful interference to radio communications. However, there is no guarantee that interference will not occur in a particular installation. If this equipment does cause harmful interference to radio or television reception, which can be determined by turning the equipment off and on, the user is encouraged to try to correct the interference by one or more of the following measures:

- Reorient or relocate the receiving antenna.
- Increase the separation between the equipment and receiver.
- Connect the equipment into an outlet on a circuit different from that to which the receiver is connected.
- Consult the dealer or an experienced radio/TV technician for help.

The device has been evaluated to meet general RF exposure requirement. The device can be used in portable exposure condition without restriction.