



Test Report

FCC: 2ATJWBM-RXCD02

| | |
|------------------|--|
| Product Name: | 720P HD Digital Color Video Baby Monitor |
| Trademark: | N/A |
| Model Name : | BM-RXCD02 BM-RXPD02, BM-RXEA02, BM-RXMP02, BabyCar |
| Prepared For : | Shenzhen Dayunlinks Co.,ltd |
| Address : | 30th Park West Zhangbei Yuanhu Road Longcheng Street Longgang District Shenzhen City. 518000. GuangDong Province . China |
| Prepared By : | Shenzhen BCTC Testing Co., Ltd. |
| Address : | BCTC Building & 1-2F, East of B Building, Pengzhou Industrial, Fuyuan 1st Road, Qiaotou Community, Fuyong Street, Bao'an District, Shenzhen, China |
| Test Date: | Apr. 29, 2019 – May 27, 2019 |
| Date of Report : | May 27, 2019 |
| Report No.: | BCTC-LH190400188E |

TEST RESULT CERTIFICATION

Applicant's name : Shenzhen Dayunlinks Co.,Ltd
Address : 30th Park West Zhangbei Yuanhu Road Longcheng Street
Longgang District Shenzhen City. 518000. GuangDong Province .
China
Manufacture's Name..... : Shenzhen Dayunlinks Co.,Ltd
Address : 30th Park West Zhangbei Yuanhu Road Longcheng Street
Longgang District Shenzhen City. 518000. GuangDong Province .
China
Product description
Product name : 720P HD Digital Color Video Baby Monitor
Trademark : N/A
Model and/or type reference : BM-RXCD02
BM-RXPD02, BM-RXEA02, BM-RXMP02, BabyCar
Standards : FCC Part15.247
ANSI C63.10:2013

This device described above has been tested by BCTC, and the test results show that the equipment under test (EUT) is in compliance with the FCC requirements. And it is applicable only to the tested sample identified in the report.

This report shall not be reproduced except in full, without the written approval of BCTC, this document may be altered or revised by BCTC, personal only, and shall be noted in the revision of the document.

Prepared by(Engineer):

Cai Fang Zhong

Cai Fang Zhong

Reviewer(Supervisor):

Eric Yang

Eric Yang

Approved(Manager):

Zero Zhou



| Table of Contents | | Page |
|---|--|-------------|
| 1 . SUMMARY OF TEST RESULTS | | 5 |
| 1.1 TEST FACILITY | | 6 |
| 1.2 MEASUREMENT UNCERTAINTY | | 6 |
| 2 . GENERAL INFORMATION | | 7 |
| 2.1 GENERAL DESCRIPTION OF EUT | | 7 |
| 2.2 DESCRIPTION OF TEST MODES | | 8 |
| 2.3 BLOCK DIGRAM SHOWING THE CONFIGURATION OF SYSTEM TESTED | | 8 |
| 2.4 DESCRIPTION OF SUPPORT UNITS(CONDUCTED MODE) | | 9 |
| 2.5 EQUIPMENTS LIST FOR ALL TEST ITEMS | | 10 |
| 3 . EMC EMISSION TEST | | 11 |
| 3.1 CONDUCTED EMISSION MEASUREMENT | | 11 |
| 3.1.1 POWER LINE CONDUCTED EMISSION LIMITS | | 11 |
| 3.1.2 TEST PROCEDURE | | 11 |
| 3.1.3 DEVIATION FROM TEST STANDARD | | 11 |
| 3.1.4 TEST SETUP | | 12 |
| 3.1.5 EUT OPERATING CONDITIONS | | 12 |
| 3.1.6 TEST RESULTS | | 12 |
| 3.2 RADIATED EMISSION MEASUREMENT | | 15 |
| 3.2.1 RADIATED EMISSION LIMITS | | 15 |
| 3.2.2 TEST PROCEDURE | | 16 |
| 3.2.3 DEVIATION FROM TEST STANDARD | | 16 |
| 3.2.4 TEST SETUP | | 16 |
| 3.2.5 EUT OPERATING CONDITIONS | | 18 |
| 3.2.6 TEST RESULTS (BETWEEN 9KHZ – 30 MHZ) | | 19 |
| 3.2.7 TEST RESULTS (BETWEEN 30MHZ – 1GHZ) | | 20 |
| 3.3 RADIATED BAND EMISSION MEASUREMENT | | 23 |
| 3.3.1 TEST REQUIREMENT: | | 23 |
| 3.3.2 TEST PROCEDURE | | 23 |
| 3.3.3 DEVIATION FROM TEST STANDARD | | 23 |
| 3.3.4 TEST SETUP | | 24 |
| 3.3.5 EUT OPERATING CONDITIONS | | 24 |
| 4 . POWER SPECTRAL DENSITY TEST | | 26 |
| 4.1 APPLIED PROCEDURES / LIMIT | | 26 |
| 4.1.1 TEST PROCEDURE | | 26 |



| | Page |
|---|-------------|
| Table of Contents | |
| 4.1.2 DEVIATION FROM STANDARD | 26 |
| 4.1.3 TEST SETUP | 26 |
| 4.1.4 EUT OPERATION CONDITIONS | 26 |
| 4.1.5 TEST RESULTS | 27 |
| 5 . BANDWIDTH TEST | 29 |
| 5.1 APPLIED PROCEDURES / LIMIT | 29 |
| 5.1.1 TEST PROCEDURE | 29 |
| 5.1.2 DEVIATION FROM STANDARD | 29 |
| 5.1.3 TEST SETUP | 29 |
| 5.1.4 EUT OPERATION CONDITIONS | 29 |
| 5.1.5 TEST RESULTS | 30 |
| 6 . PEAK OUTPUT POWER TEST | 32 |
| 6.1 APPLIED PROCEDURES / LIMIT | 32 |
| 6.1.1 TEST PROCEDURE | 32 |
| 6.1.2 DEVIATION FROM STANDARD | 32 |
| 6.1.3 TEST SETUP | 32 |
| 6.1.4 EUT OPERATION CONDITIONS | 32 |
| 6.1.5 TEST RESULTS | 33 |
| 7 . 100 KHZ BANDWIDTH OF FREQUENCY BAND EDGE | 34 |
| 7.1 APPLICABLE STANDARD | 34 |
| 7.2 TEST PROCEDURE | 34 |
| 7.3 DEVIATION FROM STANDARD | 34 |
| 7.4 TEST SETUP | 34 |
| 7.5 EUT OPERATION CONDITIONS | 34 |
| 8 . ANTENNA REQUIREMENT | 37 |
| 8.1 STANDARD REQUIREMENT | 37 |
| 8.2 EUT ANTENNA | 37 |
| 9 . EUT TEST PHOTO | 38 |
| 10 . EUT PHOTO | 40 |
| APPENDIX-PHOTOGRAPHS OF EUT CONSTRUCTIONAL DETAILS | |

1. SUMMARY OF TEST RESULTS

Test procedures according to the technical standards:

| RSS-247 Issue 2: February 2017 FCC Part15 (15.247) , Subpart C | | | |
|---|-----------------------------------|----------|--------|
| Standard Section | Test Item | Judgment | Remark |
| RSS-GEN 8.8 RSS-247 3.1 15.207 | Conducted Emission | PASS | |
| RSS-247 5.2 (a) 15.247 (a)(2) | 6dB Bandwidth | PASS | |
| RSS-247 5.4 (b) 15.247 (b) | Peak Output Power | PASS | |
| RSS-247 5.5 15.247 (d) | Radiated Spurious Emission | PASS | |
| RSS-247 5.2 (b) 15.247 (e) | Power Spectral Density | PASS | |
| RSS-247 5.5 15.205 | Restricted Band of Operation | PASS | |
| RSS-Gen.6.7 15.247(d) | Band Edge (Out of Band Emissions) | PASS | |
| RSS-GEN 8.8 RSS-247 3.1 15.203 | Antenna Requirement | PASS | |

NOTE:

(1) "N/A" denotes test is not applicable in this Test Report

1.1 TEST FACILITY

Shenzhen BCTC Testing Co., Ltd.

Add.: BCTC Building & 1-2F, East of B Building, Pengzhou Industrial, Fuyuan 1st Road, Qiaotou Community, Fuyong Street, Bao'an District, Shenzhen, China

FCC Test Firm Registration Number: 712850

Test site MRA number: CN1212

IC Registered No.: 23583

1.2 MEASUREMENT UNCERTAINTY

The reported uncertainty of measurement $y \pm U$, where expanded uncertainty U is based on a standard uncertainty multiplied by a coverage factor of $k=2$, providing a level of confidence of approximately 95 %.

| No. | Item | Uncertainty |
|-----|--|-------------|
| 1 | 3m chamber Radiated spurious emission(30MHz-1GHz) | U=4.3dB |
| 2 | 3m chamber Radiated spurious emission(1GHz-18GHz) | U=4.5dB |
| 3 | 3m chamber Radiated spurious emission(18GHz-40GHz) | U=3.34dB |
| 4 | Conducted Adjacent channel power | U=1.38dB |
| 5 | Conducted output power uncertainty Above 1G | U=1.576dB |
| 6 | Conducted output power uncertainty below 1G | U=1.28dB |
| 7 | humidity uncertainty | U=5.3% |
| 8 | Temperature uncertainty | U=0.59°C |

2. GENERAL INFORMATION

2.1 GENERAL DESCRIPTION OF EUT

| | | |
|--|---|--------------------|
| Equipment | 720P HD Digital Color Video Baby Monitor | |
| Trade Name | N/A | |
| Model Name | BM-RXCD02 BM-RXPD02, BM-RXEA02, BM-RXMP02, BabyCar | |
| Model Difference | All the model are the same circuit and RF module, except model names . | |
| Product Description | The EUT is a 720P HD Digital Color Video Baby Monitor | |
| | Operation Frequency: | 2410-2477 MHz |
| | Modulation Type: | GFSK |
| | Number Of Channel | 20CH |
| | Antenna Designation: | Please see Note 3. |
| Based on the application, features, or specification exhibited in User's Manual, the EUT is considered as an ITE/Computing Device. More details of EUT technical specification, please refer to the User's Manual. | | |
| Channel List | Please refer to the Note 2. | |
| Ratings | DC 5V | |
| Adapter | Model No.: SAN-05015 Input: 100-240V~50/60Hz, 0.35A Output: DC 5V, 1.5A | |
| Connecting I/O Port(s) | Please refer to the User's Manual | |

Note:

1. For a more detailed features description, please refer to the manufacturer's specifications or the User's Manual.



2.

| Channel List | | | | | |
|--------------|-----------------|---------|-----------------|---------|-----------------|
| Channel | Frequency (MHz) | Channel | Frequency (MHz) | Channel | Frequency (MHz) |
| 01 | 2410 | 08 | 2434.5 | 15 | 2459 |
| 02 | 2413.5 | 09 | 2438 | 16 | 2462.5 |
| 03 | 2417 | 10 | 2441.5 | 17 | 2466 |
| 04 | 2420.5 | 11 | 2445 | 18 | 2469.5 |
| 05 | 2424 | 12 | 2448.5 | 19 | 2473 |
| 06 | 2427.5 | 13 | 2452 | 20 | 2477 |
| 07 | 2431 | 14 | 2455.5 | \ | \ |

3.

Table for Filed Antenna

| Ant. | Brand | Model Name | Antenna Type | Gain (dBi) |
|------|-------|------------|------------------|------------|
| 1 | N/A | N/A | External antenna | 1 |

2.2 DESCRIPTION OF TEST MODES

To investigate the maximum EMI emission characteristics generates from EUT, the test system was pre-scanning tested base on the consideration of following EUT operation mode or test configuration mode which possible have effect on EMI emission level. Each of these EUT operation mode(s) or test configuration mode(s) mentioned above was evaluated respectively.

| For All Mode | Description | Modulation Type |
|--------------|---|-----------------|
| Mode 1 | CH01 | GFSK |
| Mode 2 | CH10 | |
| Mode 3 | CH20 | |
| Mode 4 | Link mode(conducted emission and Radiated emission) | |

Note:

- (1) The measurements are performed at the highest, middle, lowest available channels.
- (2) Fully-charged battery is used during the test

2.3 BLOCK DIGRAM SHOWING THE CONFIGURATION OF SYSTEM TESTED

Conducted Emission

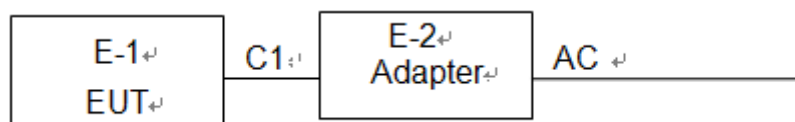



Radiated Spurious Emission

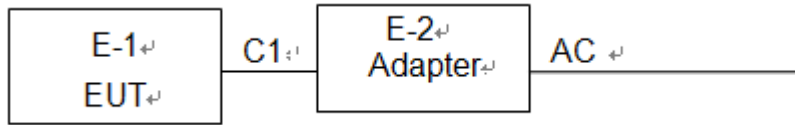

2.4 DESCRIPTION OF SUPPORT UNITS(CONDUCTED MODE)

The EUT has been tested as an independent unit together with other necessary accessories or support units. The following support units or accessories were used to form a representative test configuration during the tests.

| Item | Equipment | Mfr/Brand | Model/Type No. | Series No. | Note |
|------|--|-----------|----------------|------------|-----------|
| E-1 | 720P HD Digital Color Video Baby Monitor | N/A | BM-RXCD02 | N/A | EUT |
| E-2 | Adapter | N/A | SAN-05015 | N/A | Auxiliary |

| Item | Shielded Type | Ferrite Core | Length | Note |
|------|---------------|--------------|--------|----------------------|
| C1 | NO | NO | 1.0M | USB cable unshielded |

Note:

- (1) The support equipment was authorized by Declaration of Confirmation.
- (2) For detachable type I/O cable should be specified the length in cm in 『Length』 column.

2.5 EQUIPMENTS LIST FOR ALL TEST ITEMS

Radiation Test equipment

| Item | Equipment | Manufacturer | Type No. | Serial No. | Last calibration | Calibrated until |
|------|----------------------------------|--------------|---------------|---------------|------------------|------------------|
| 1 | Spectrum Analyzer (9kHz-26.5GHz) | Agilent | E4407B | MY45109572 | 2018.06.20 | 2019.06.20 |
| 2 | Test Receiver (9kHz-7GHz) | R&S | ESR7 | 101154 | 2018.06.20 | 2019.06.20 |
| 3 | Bilog Antenna (30MHz-3GHz) | SCHWARZBEC K | VULB9163 | VULB9163-942 | 2018.06.23 | 2019.06.23 |
| 4 | Horn Antenna (1GHz-18GHz) | SCHWARZBEC K | BBHA9120D | 1541 | 2018.06.23 | 2019.06.22 |
| 5 | Horn Antenna (18GHz-40GHz) | SCHWARZBEC K | BBHA9170 | 822 | 2018.08.06 | 2019.08.06 |
| 6 | Amplifier (9kHz-6GHz) | SCHWARZBEC K | BBV9744 | 9744-0037 | 2018.06.20 | 2019.06.20 |
| 7 | Amplifier (0.5GHz-18GHz) | SCHWARZBEC K | BBV9718 | 9718-309 | 2018.06.20 | 2019.06.20 |
| 8 | Amplifier (18GHz-40GHz) | MITEQ | TTA1840-35-HG | 2034381 | 2018.08.06 | 2019.08.06 |
| 9 | Loop Antenna (9kHz-30MHz) | SCHWARZBEC K | FMZB1519B | 014 | 2018.06.23 | 2019.06.23 |
| 10 | RF cables1 (9kHz-30MHz) | Huber+Suhnar | 9kHz-30MHz | B1702988-0008 | 2019.02.12 | 2020.02.12 |
| 11 | RF cables2 (30MHz-1GHz) | Huber+Suhnar | 30MHz-1GHz | 1486150 | 2019.03.27 | 2020.03.27 |
| 12 | RF cables3 (1GHz-40GHz) | Huber+Suhnar | 1GHz-40GHz | 1607106 | 2018.06.19 | 2019.06.19 |
| 13 | Power Metter | Keysight | E4419 | \ | 2018.06.15 | 2019.06.15 |
| 14 | Power Sensor (AV) | Keysight | E9 300A | \ | 2018.06.15 | 2019.06.15 |
| 15 | Signal Analyzer 20kHz-26.5GHz | KEYSIGHT | N9020A | MY49100060 | 2018.08.14 | 2019.08.13 |
| 16 | Test Receiver 9kHz-40GHz | R&S | FSP40 | 100550 | 2018.06.13 | 2019.06.12 |
| 17 | D.C. Power Supply | LongWei | TPR-6405D | \ | \ | \ |
| 18 | Software | Frad | EZ-EMC | FA-03A2 RE | \ | \ |

Conduction Test equipment

| Item | Equipment | Manufacturer | Type No. | Serial No. | Last calibration | Calibrated until |
|------|---------------|--------------|------------|---------------|------------------|------------------|
| 1 | Test Receiver | R&S | ESR3 | 102075 | 2018.06.20 | 2019.06.20 |
| 2 | LISN | SCHWARZBEC K | NSLK8127 | 8127739 | 2018.06.19 | 2019.06.19 |
| 3 | LISN | R&S | ENV216 | 101375 | 2018.06.20 | 2019.06.20 |
| 4 | RF cables | Huber+Suhnar | 9kHz-30MHz | B1702988-0008 | 2019.02.12 | 2020.02.12 |
| 5 | Software | Frad | EZ-EMC | EMC-CON 3A1 | \ | \ |

3. EMC EMISSION TEST

3.1 CONDUCTED EMISSION MEASUREMENT

3.1.1 POWER LINE CONDUCTED EMISSION Limits (Frequency Range 150KHz-30MHz)

| FREQUENCY (MHz) | Limit (dBuV) | | Standard |
|-----------------|--------------|-----------|----------|
| | Quas -peak | Average | |
| 0.15 -0.5 | 66 - 56 * | 56 - 46 * | FCC |
| 0.50 -5.0 | 56.00 | 46.00 | FCC |
| 5.0 -30.0 | 60.00 | 50.00 | FCC |

Note:

- (1) The tighter limit applies at the band edges.
- (2) The limit of " * " marked band means the limitation decreases linearly with the logarithm of the frequency in the range.

The following table is the setting of the receiver

| Receiver Parameters | Setting |
|---------------------|----------|
| Attenuation | 10 dB |
| Start Frequency | 0.15 MHz |
| Stop Frequency | 30 MHz |
| IF Bandwidth | 9 kHz |

3.1.2 TEST PROCEDURE

- a. The EUT was placed 0.8 meters from the horizontal ground plane with EUT being connected to the power mains through a line impedance stabilization network (LISN). All other support equipments powered from additional LISN(s). The LISN provide 50 Ohm/ 50uH of coupling impedance for the measuring instrument.
- b. Interconnecting cables that hang closer than 40 cm to the ground plane shall be folded back and forth in the center forming a bundle 30 to 40 cm long.
- c. I/O cables that are not connected to a peripheral shall be bundled in the center. The end of the cable may be terminated, if required, using the correct terminating impedance. The overall length shall not exceed 1 m.
- d. LISN at least 80 cm from nearest part of EUT chassis.
- e. For the actual test configuration, please refer to the related Item –EUT Test Photos.

3.1.3 DEVIATION FROM TEST STANDARD

No deviation

3.1.4 TEST SETUP

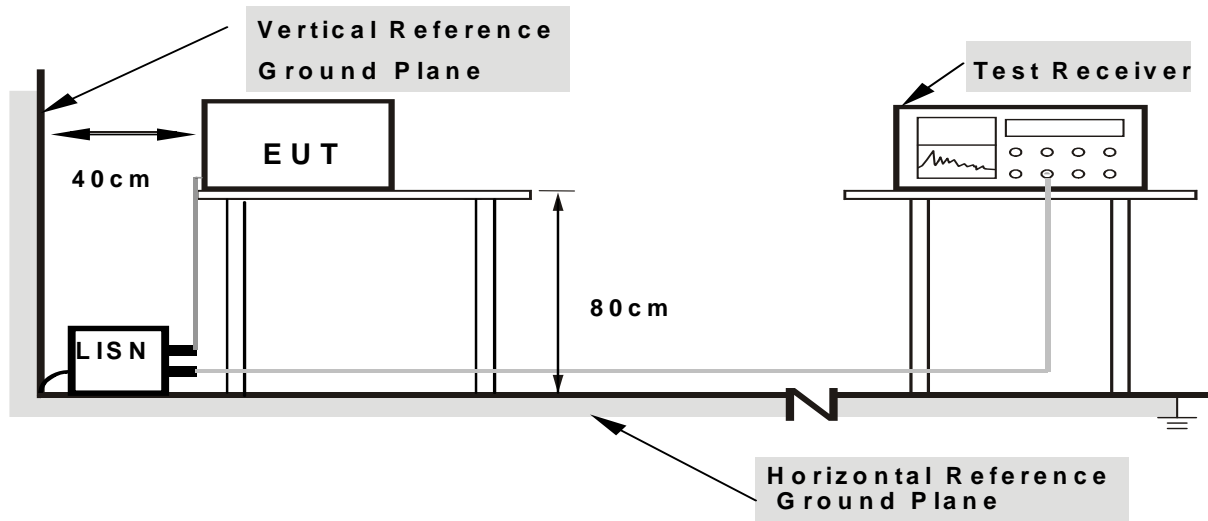

Note: 1.Support units were connected to second LISN.

2.Both of LISNs (AMN) are 80 cm from EUT and at least 80 from other units and other metal planes

3.1.5 EUT OPERATING CONDITIONS

The EUT was configured for testing in a typical fashion (as a customer would normally use it). The EUT has been programmed to continuously transmit during test. This operating condition was tested and used to collect the included data.

We pretest AC 120V and AC 240V, the worst voltage was AC 120V and the data recording in the report.

3.1.6 TEST RESULTS



| | | | |
|----------------|--------------|---------------------|-----|
| Temperature : | 26°C | Relative Humidity : | 54% |
| Test Voltage : | AC 120V/60Hz | Phase : | L |
| Test Mode : | Mode 4 | | |

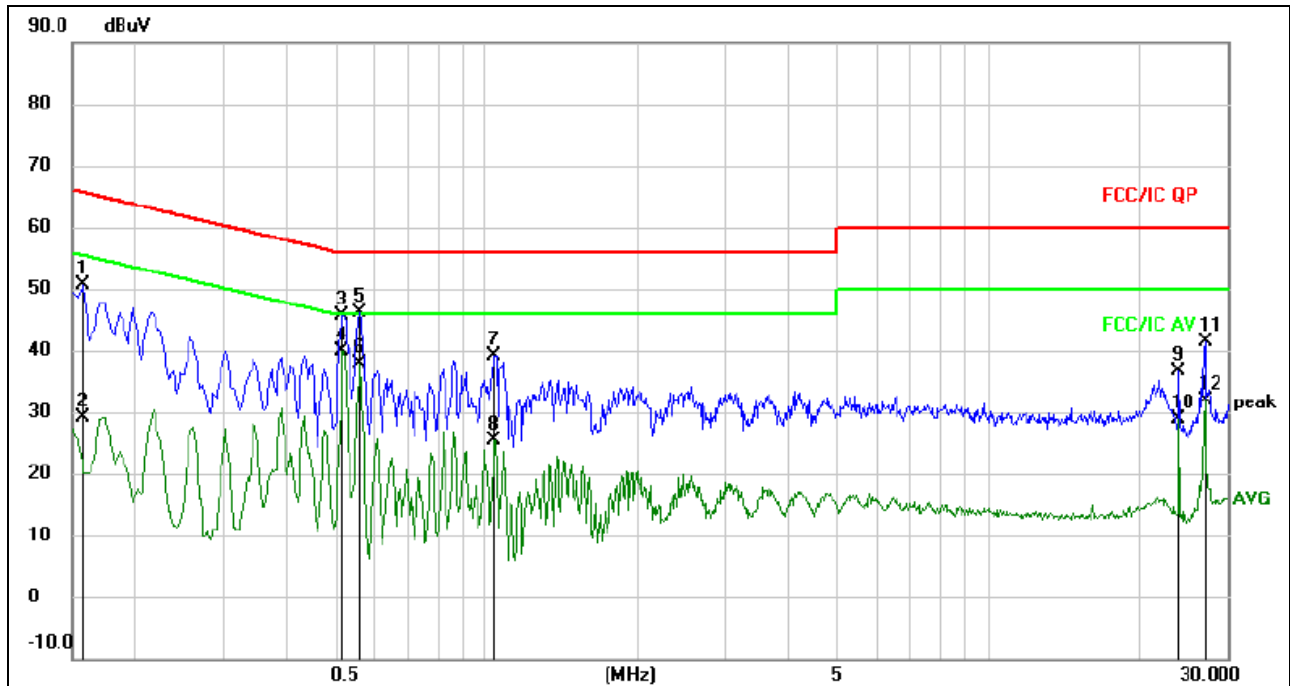

Remark:

1. All readings are Quasi-Peak and Average values.
2. Factor = Insertion Loss + Cable Loss.

| No. | Mk. | Freq. MHz | Reading Level dBuV | Correct Factor | Measure- ment dBuV | Limit dBuV | Over dB | Detector | Comment |
|-----|-----|--------------|--------------------------|-------------------|--------------------------|---------------|------------|----------|---------|
| 1 | | 0.1580 | 41.04 | 9.51 | 50.55 | 65.57 | -15.02 | QP | |
| 2 | | 0.1580 | 19.56 | 9.51 | 29.07 | 55.57 | -26.50 | AVG | |
| 3 | | 0.5180 | 36.05 | 9.66 | 45.71 | 56.00 | -10.29 | QP | |
| 4 | * | 0.5180 | 30.22 | 9.66 | 39.88 | 46.00 | -6.12 | AVG | |
| 5 | | 0.5620 | 36.29 | 9.84 | 46.13 | 56.00 | -9.87 | QP | |
| 6 | | 0.5620 | 28.03 | 9.84 | 37.87 | 46.00 | -8.13 | AVG | |
| 7 | | 1.0380 | 29.65 | 9.57 | 39.22 | 56.00 | -16.78 | QP | |
| 8 | | 1.0380 | 15.87 | 9.57 | 25.44 | 46.00 | -20.56 | AVG | |
| 9 | | 24.0020 | 26.83 | 9.75 | 36.58 | 60.00 | -23.42 | QP | |
| 10 | | 24.0020 | 19.14 | 9.75 | 28.89 | 50.00 | -21.11 | AVG | |
| 11 | | 26.9860 | 31.71 | 9.73 | 41.44 | 60.00 | -18.56 | QP | |
| 12 | | 26.9860 | 22.09 | 9.73 | 31.82 | 50.00 | -18.18 | AVG | |



| | | | |
|----------------|--------------|---------------------|-----|
| Temperature : | 26℃ | Relative Humidity : | 54% |
| Test Voltage : | AC 120V/60Hz | Phase : | N |
| Test Mode : | Mode 4 | | |

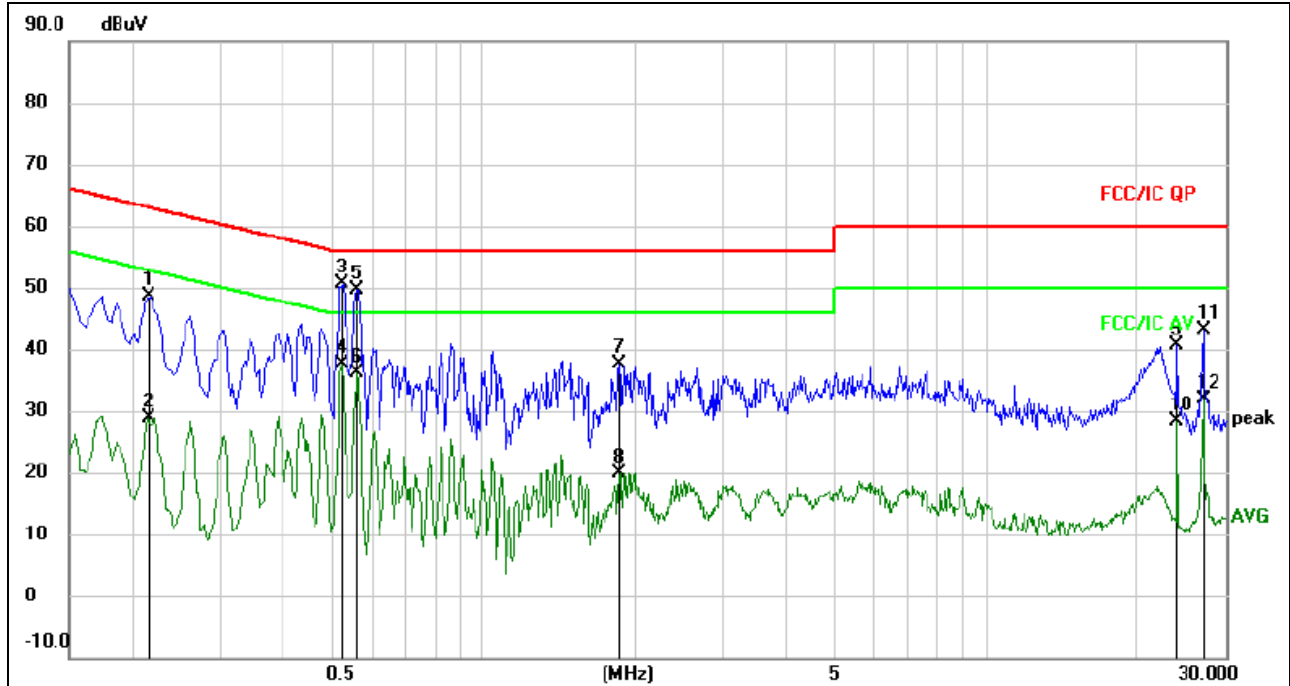

Remark:

1. All readings are Quasi-Peak and Average values.
2. Factor = Insertion Loss + Cable Loss.

| No. | Mk. | Freq. MHz | Reading Level dBuV | Correct Factor | Measure- ment dBuV | Limit dBuV | Over dB | Detector | Comment |
|-----|-----|--------------|--------------------------|-------------------|--------------------------|---------------|------------|----------|---------|
| 1 | | 0.2140 | 39.04 | 9.48 | 48.52 | 63.05 | -14.53 | QP | |
| 2 | | 0.2140 | 19.50 | 9.48 | 28.98 | 53.05 | -24.07 | AVG | |
| 3 | * | 0.5220 | 40.96 | 9.68 | 50.64 | 56.00 | -5.36 | QP | |
| 4 | | 0.5220 | 27.87 | 9.68 | 37.55 | 46.00 | -8.45 | AVG | |
| 5 | | 0.5620 | 39.71 | 9.84 | 49.55 | 56.00 | -6.45 | QP | |
| 6 | | 0.5620 | 26.40 | 9.84 | 36.24 | 46.00 | -9.76 | AVG | |
| 7 | | 1.8620 | 28.06 | 9.59 | 37.65 | 56.00 | -18.35 | QP | |
| 8 | | 1.8620 | 10.34 | 9.59 | 19.93 | 46.00 | -26.07 | AVG | |
| 9 | | 24.0020 | 30.79 | 9.75 | 40.54 | 60.00 | -19.46 | QP | |
| 10 | | 24.0020 | 18.59 | 9.75 | 28.34 | 50.00 | -21.66 | AVG | |
| 11 | | 26.9900 | 33.49 | 9.73 | 43.22 | 60.00 | -16.78 | QP | |
| 12 | | 26.9900 | 22.06 | 9.73 | 31.79 | 50.00 | -18.21 | AVG | |

3.2 RADIATED EMISSION MEASUREMENT

3.2.1 RADIATED EMISSION LIMITS (Frequency Range 9kHz-1000MHz)

20dBc in any 100 kHz bandwidth outside the operating frequency band. In case the emission fall within the restricted band specified on 15.205(a), then the 15.209(a) limit in the table below has to be followed.

| Frequencies (MHz) | Field Strength (micorvolts/meter) | Measurement Distance (meters) |
|-------------------|-----------------------------------|-------------------------------|
| 0.009~0.490 | 2400/F(KHz) | 300 |
| 0.490~1.705 | 24000/F(KHz) | 30 |
| 1.705~30.0 | 30 | 30 |
| 30~88 | 100 | 3 |
| 88~216 | 150 | 3 |
| 216~960 | 200 | 3 |
| Above 960 | 500 | 3 |

LIMITS OF RADIATED EMISSION MEASUREMENT (Above 1000MHz)

| FREQUENCY (MHz) | Limit (dBuV/m) (at 3M) | |
|-----------------|------------------------|---------|
| | PEAK | AVERAGE |
| Above 1000 | 74 | 54 |

Notes:

- (1) The limit for radiated test was performed according to FCC PART 15C.
- (2) The tighter limit applies at the band edges.
- (3) Emission level (dBuV/m)=20log Emission level (uV/m).

FREQUENCY RANGE OF RADIATED MEASUREMENT (For unintentional radiators)

| Highest frequency generated or Upper frequency of measurement used in the device or on which the device operates or tunes (MHz) | Range (MHz) |
|---|---|
| Below 1.705 | 30 |
| 1.705 – 108 | 1000 |
| 108 – 500 | 2000 |
| 500 – 1000 | 5000 |
| Above 1000 | 5 th harmonic of the highest frequency or 40 GHz, whichever is lower |

| Spectrum Parameter | Setting |
|---------------------------------------|--|
| Attenuation | Auto |
| Start Frequency | 1000 MHz |
| Stop Frequency | 10th carrier harmonic |
| RB / VB (emission in restricted band) | 1 MHz / 1 MHz for Peak, 1 MHz / 10Hz for Average |

| Receiver Parameter | Setting |
|------------------------|----------------------------------|
| Attenuation | Auto |
| Start ~ Stop Frequency | 9kHz~150kHz / RB 200Hz for QP |
| Start ~ Stop Frequency | 150kHz~30MHz / RB 9kHz for QP |
| Start ~ Stop Frequency | 30MHz~1000MHz / RB 120kHz for QP |

3.2.2 TEST PROCEDURE

- a. The measuring distance of at 3 m shall be used for measurements at frequency up to 25GHz. For frequencies above 1GHz, any suitable measuring distance may be used.
- b. The EUT was placed on the top of a rotating table 0.8 meters above the ground at a 3 meter semi-chamber test. The table was rotated 360 degrees to determine the position of the highest radiation.
- c. The height of the equipment or of the substitution antenna shall be 0.8m; above 1GHz, the height was 1.5m, the height of the test antenna shall vary between 1 m to 4 m. Both horizontal and vertical polarizations of the antenna are set to make the measurement.
- d. The initial step in collecting conducted emission data is a spectrum analyzer peak detector mode pre-scanning the measurement frequency range. Significant peaks are then marked and then Quasi Peak detector mode re-measured.
- e. If the Peak Mode measured value compliance with and lower than Quasi Peak Mode Limit, the EUT shall be deemed to meet QP Limits and then no additional QP Mode measurement performed.
- f. For the actual test configuration, please refer to the related Item –EUT Test Photos.
- g. For the radiated emission test above 1GHz:
 Place the measurement antenna away from each area of the EUT determined to be a source of emissions at the specified measurement distance, while keeping the measurement antenna aimed at the source of emissions at each frequency of significant emissions, with polarization oriented for maximum response.
 The measurement antenna may have to be higher or lower than the EUT, depending on the radiation pattern of the emission and staying aimed at the emission source for receiving the maximum signal. The final measurement antenna elevation shall be that which maximizes the emissions. The measurement antenna elevation for maximum emissions shall be restricted to a range of heights of from 1 m to 4 m above the ground or reference ground plane.
 Note:
 Both horizontal and vertical antenna polarities were tested and performed pretest to three orthogonal axis. The worst case emissions were reported

3.2.3 DEVIATION FROM TEST STANDARD

No deviation

3.2.4 TEST SETUP

(A) Radiated Emission Test-Up Frequency Below 30MHz

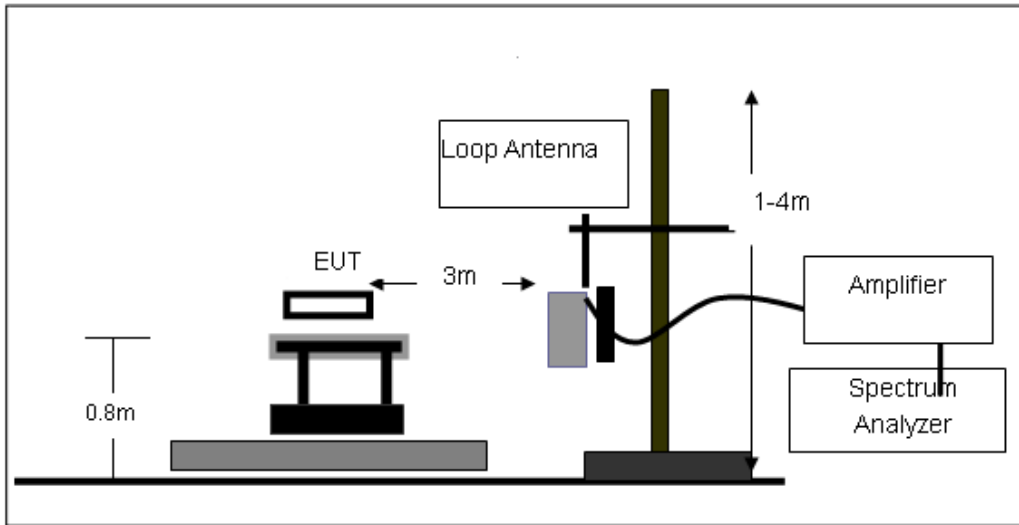

(B) Radiated Emission Test-Up Frequency 30MHz~1GHz

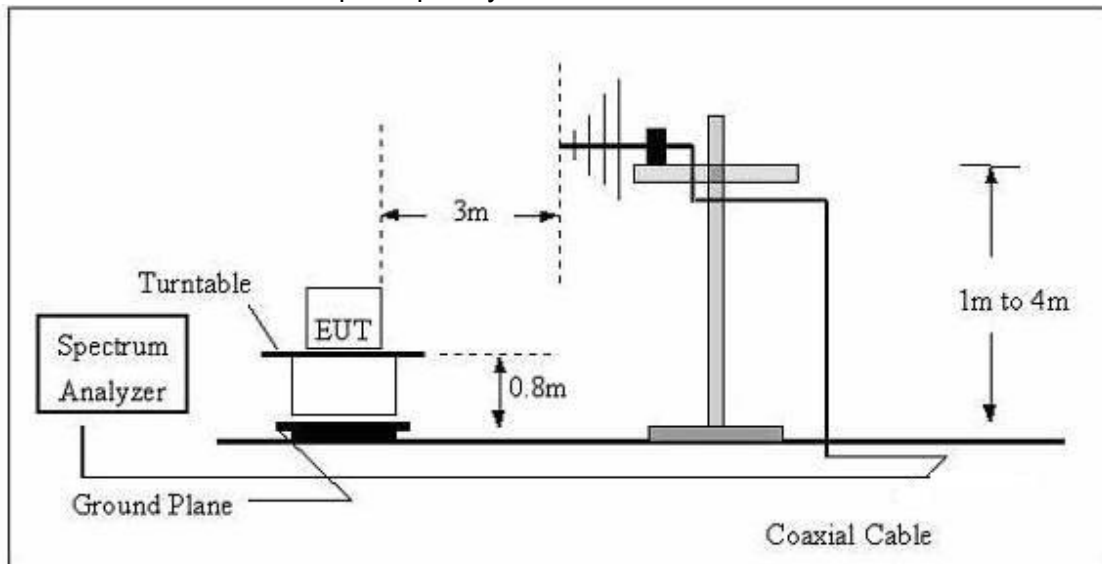

(C) Radiated Emission Test-Up Frequency Above 1GHz

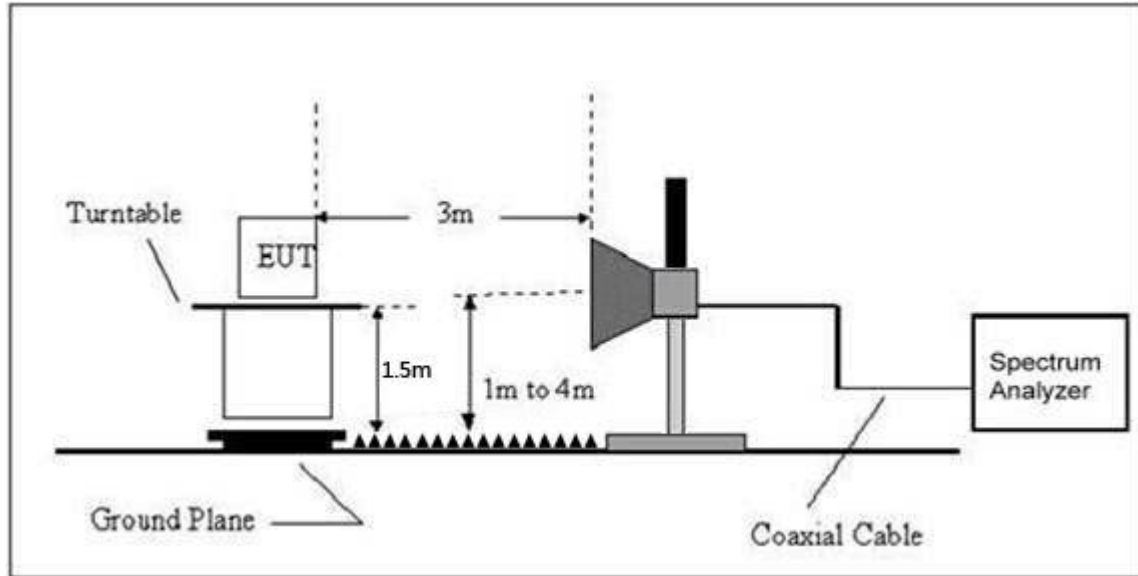

3.2.5 EUT OPERATING CONDITIONS

The EUT tested system was configured as the statements of 2.4 Unless otherwise a special operating condition is specified in the follows during the testing.

3.2.6 TEST RESULTS (BETWEEN 9KHZ – 30 MHZ)

| | | | |
|--------------|---------|--------------------|-------------------|
| Temperature: | 26℃ | Relative Humidity: | 54% |
| Pressure: | 101 kPa | Test Voltage : | DC 5V for adapter |
| Test Mode : | Mode 4 | Polarization : | -- |

| Freq. | Reading | Limit | Margin | State |
|-------|----------|----------|--------|-------|
| (MHz) | (dBuV/m) | (dBuV/m) | (dB) | P/F |
| -- | -- | -- | -- | PASS |
| -- | -- | -- | -- | PASS |

NOTE:

The amplitude of spurious emissions which are attenuated by more than 20dB below the permissible value has no need to be reported.

Distance extrapolation factor = $40 \log(\text{specific distance}/\text{test distance})$ (dB);

Limit line = specific limits(dBuv) + distance extrapolation factor.

3.2.7 TEST RESULTS (BETWEEN 30MHZ – 1GHZ)

| | | | |
|----------------|-------------------|---------------------|------------|
| Temperature : | 26°C | Relative Humidity : | 54% |
| Test Voltage : | DC 5V for adapter | Polarization : | Horizontal |
| Test Mode : | Mode 4 | | |

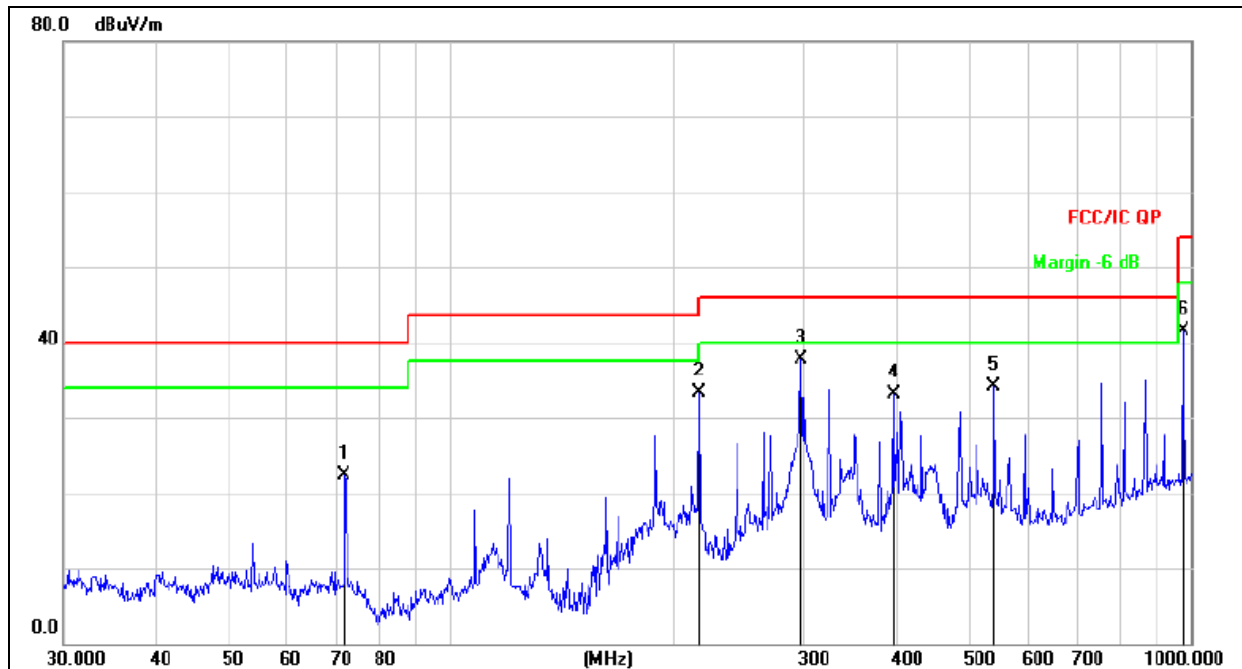

Remark:

Factor = Antenna Factor + Cable Loss – Pre-amplifier.

| No. | Mk. | Freq. | Reading Level | Correct Factor | Measurement | Limit | Over | |
|-----|-----|----------|---------------|----------------|-------------|-------|--------|----------|
| | | MHz | dBuV | dB | dBuV/m | dB/m | dB | Detector |
| 1 | | 71.8320 | 40.95 | -18.60 | 22.35 | 40.00 | -17.65 | QP |
| 2 | | 216.0240 | 49.32 | -15.93 | 33.39 | 46.00 | -12.61 | QP |
| 3 | * | 297.2241 | 51.42 | -13.69 | 37.73 | 46.00 | -8.27 | QP |
| 4 | | 396.2415 | 44.21 | -11.18 | 33.03 | 46.00 | -12.97 | QP |
| 5 | | 541.3725 | 42.02 | -7.90 | 34.12 | 46.00 | -11.88 | QP |
| 6 | | 972.3374 | 42.49 | -0.98 | 41.51 | 54.00 | -12.49 | QP |



| | | | |
|----------------|-------------------|---------------------|----------|
| Temperature : | 26℃ | Relative Humidity : | 54% |
| Test Voltage : | DC 5V for adapter | Polarization : | Vertical |
| Test Mode : | Mode 4 | | |

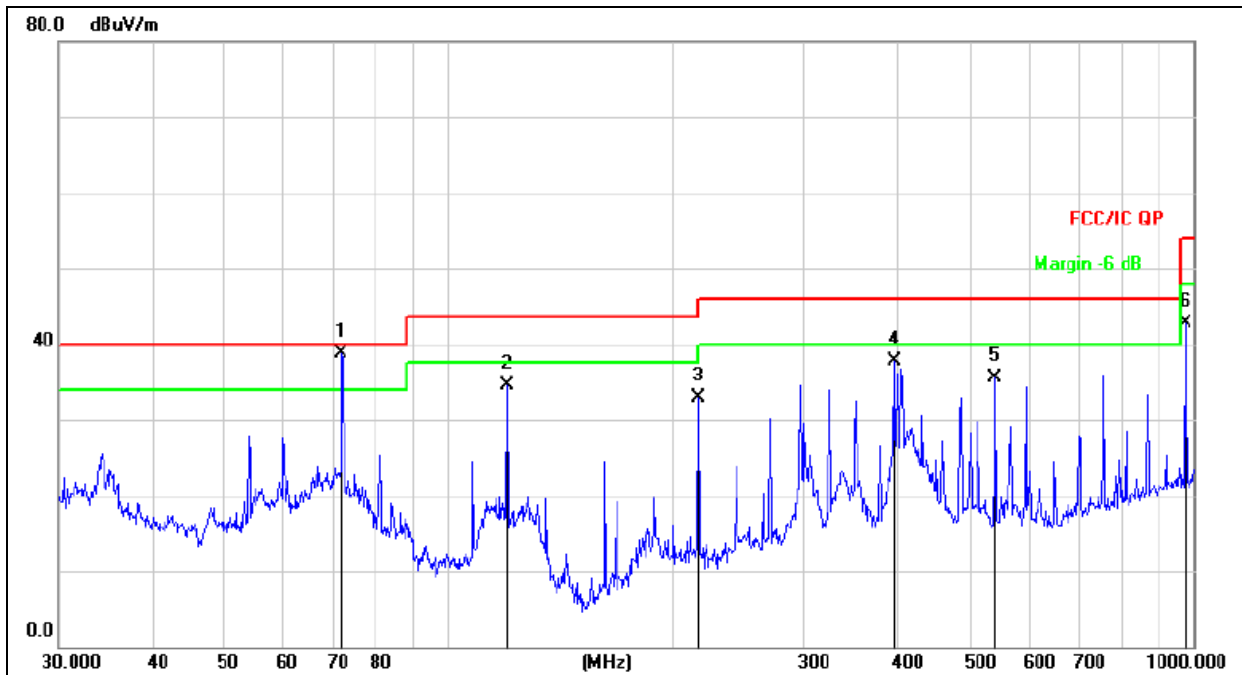

Remark:
Factor = Antenna Factor + Cable Loss – Pre-amplifier.

| No. | Mk. | Freq. MHz | Reading Level dBuV | Correct Factor dB | Measure- ment dBuV/m | Limit dB/m | Over dB | Detector |
|-----|-----|--------------|--------------------------|-------------------------|----------------------------|---------------|------------|----------|
| 1 | * | 71.8320 | 57.25 | -18.60 | 38.65 | 40.00 | -1.35 | QP |
| 2 | | 119.8556 | 52.15 | -17.56 | 34.59 | 43.50 | -8.91 | QP |
| 3 | | 216.0240 | 48.85 | -15.93 | 32.92 | 46.00 | -13.08 | QP |
| 4 | | 396.2415 | 48.85 | -11.18 | 37.67 | 46.00 | -8.33 | QP |
| 5 | | 541.3725 | 43.48 | -7.90 | 35.58 | 46.00 | -10.42 | QP |
| 6 | | 972.3374 | 43.69 | -0.98 | 42.71 | 54.00 | -11.29 | QP |

3.2.8 TEST RESULTS (1ghz~25ghz)

GFSK

| Polar (H/V) | Frequency | Meter Reading | Pre-amplifier | Cable Loss | Antenna Factor | Emission Level | Limits | Margin | Detector Type |
|----------------------------|-----------|---------------|---------------|------------|----------------|----------------|----------|--------|---------------|
| | (MHz) | (dBuV) | (dB) | (dB) | (dB) | (dBuV/m) | (dBuV/m) | (dB) | |
| Low Channel:2410MHz | | | | | | | | | |
| V | 4822.00 | 54.32 | 39.55 | 7.77 | 25.66 | 48.20 | 74.00 | -25.80 | PK |
| V | 4822.00 | 43.43 | 39.55 | 7.77 | 25.66 | 37.31 | 54.00 | -16.69 | AV |
| V | 7233.00 | 50.65 | 38.33 | 7.3 | 24.55 | 44.17 | 74.00 | -29.83 | PK |
| V | 7233.00 | 43.69 | 38.33 | 7.3 | 24.55 | 37.21 | 54.00 | -16.79 | AV |
| V | 15450.00 | 51.42 | 35.23 | 6.6 | 26.59 | 49.38 | 74.00 | -24.62 | PK |
| H | 4822.00 | 54.98 | 39.55 | 7.77 | 25.66 | 48.86 | 74.00 | -25.14 | PK |
| H | 4822.00 | 43.37 | 39.55 | 7.77 | 25.66 | 37.25 | 54.00 | -16.75 | AV |
| H | 7233.00 | 54.93 | 38.33 | 7.3 | 23.55 | 47.45 | 74.00 | -26.55 | PK |
| H | 7233.00 | 43.46 | 38.33 | 7.3 | 23.22 | 35.65 | 54.00 | -18.35 | AV |
| H | 15450.00 | 52.22 | 35.45 | 6.6 | 27.88 | 51.25 | 74.00 | -22.75 | PK |

| Polar (H/V) | Frequency | Meter Reading | Pre-amplifier | Cable Loss | Antenna Factor | Emission Level | Limits | Margin | Detector Type |
|---------------------------------|-----------|---------------|---------------|------------|----------------|----------------|----------|--------|---------------|
| | (MHz) | (dBuV) | (dB) | (dB) | (dB) | (dBuV/m) | (dBuV/m) | (dB) | |
| Middle Channel:2441.5MHz | | | | | | | | | |
| V | 4882.00 | 53.44 | 38.89 | 7.57 | 25.45 | 47.57 | 74.00 | -26.43 | PK |
| V | 4882.00 | 44.00 | 38.89 | 7.57 | 25.45 | 38.13 | 54.00 | -15.87 | AV |
| V | 7323.00 | 50.85 | 38.78 | 7.35 | 24.78 | 44.20 | 74.00 | -29.80 | PK |
| V | 7323.00 | 43.67 | 38.78 | 7.35 | 24.78 | 37.02 | 54.00 | -16.98 | AV |
| V | 15450.00 | 53.60 | 35.89 | 6.42 | 26.47 | 50.60 | 74.00 | -23.40 | PK |
| H | 4882.00 | 54.76 | 38.89 | 7.57 | 25.45 | 48.89 | 74.00 | -25.11 | PK |
| H | 4882.00 | 43.21 | 38.89 | 7.57 | 25.45 | 37.34 | 54.00 | -16.66 | AV |
| H | 7323.00 | 54.34 | 38.78 | 7.35 | 24.78 | 47.69 | 74.00 | -26.31 | PK |
| H | 7323.00 | 43.16 | 38.78 | 7.35 | 24.78 | 36.51 | 54.00 | -17.49 | AV |
| H | 15450.00 | 54.58 | 36.68 | 6.42 | 26.65 | 50.97 | 74.00 | -23.03 | PK |

| Polar (H/V) | Frequency | Meter Reading | Pre-amplifier | Cable Loss | Antenna Factor | Emission Level | Limits | Margin | Detector Type |
|------------------------------|-----------|---------------|---------------|------------|----------------|----------------|----------|--------|---------------|
| | (MHz) | (dBuV) | (dB) | (dB) | (dB) | (dBuV/m) | (dBuV/m) | (dB) | |
| High Channel: 2477MHz | | | | | | | | | |
| V | 4954.00 | 53.08 | 38.75 | 7.38 | 25.45 | 47.16 | 74.00 | -26.84 | PK |
| V | 4954.00 | 43.95 | 38.75 | 7.38 | 25.45 | 38.03 | 54.00 | -15.97 | AV |
| V | 7431.00 | 50.19 | 38.65 | 7.15 | 24.78 | 43.47 | 74.00 | -30.53 | PK |
| V | 7431.00 | 43.73 | 38.65 | 7.15 | 24.78 | 37.01 | 54.00 | -16.99 | AV |
| V | 15450.00 | 51.10 | 35.58 | 6.25 | 26.47 | 48.24 | 74.00 | -25.76 | PK |
| H | 4954.00 | 54.40 | 38.75 | 7.38 | 25.45 | 48.48 | 74.00 | -25.52 | PK |
| H | 4954.00 | 43.11 | 38.75 | 7.38 | 25.45 | 37.19 | 54.00 | -16.81 | AV |
| H | 7431.00 | 51.16 | 38.65 | 7.15 | 24.78 | 44.44 | 74.00 | -29.56 | PK |
| H | 7431.00 | 43.23 | 38.65 | 7.15 | 24.78 | 36.51 | 54.00 | -17.49 | AV |
| H | 15450.00 | 54.48 | 36.42 | 6.25 | 26.65 | 50.96 | 74.00 | -23.04 | PK |

Remark:

1. Emission Level = Meter Reading + Antenna Factor + Cable Loss – Pre-amplifier,

Margin= Emission Level - Limit

2. If peak below the average limit, the average emission was no test.

3. The amplitude of spurious emissions which are attenuated by more than 20dB below the permissible value has no need to be reported.

3.3 RADIATED BAND EMISSION MEASUREMENT

3.3.1 TEST REQUIREMENT:

FCC Part15 C Section 15.209 and 15.205

LIMITS OF RADIATED EMISSION MEASUREMENT (Above 1000MHz)

| FREQUENCY (MHz) | Limit (dBuV/m) (at 3M) | |
|-----------------|------------------------|---------|
| | PEAK | AVERAGE |
| Above 1000 | 74 | 54 |

Notes:

- (1) The limit for radiated test was performed according to FCC PART 15C.
- (2) The tighter limit applies at the band edges.
- (3) Emission level (dBuV/m)=20log Emission level (uV/m).

| Spectrum Parameter | Setting |
|---------------------------------------|--|
| Attenuation | Auto |
| Start Frequency | 2300MHz |
| Stop Frequency | 2520 |
| RB / VB (emission in restricted band) | 1 MHz / 1 MHz for Peak, 1 MHz / 10Hz for Average |

3.3.2 TEST PROCEDURE

Above 1GHz test procedure as below:

- a. 1. The EUT was placed on the top of a rotating table 1.5 meters above the ground at a 3 meter camber. The table was rotated 360 degrees to determine the position of the highest radiation.
- b. The EUT was set 3 meters away from the interference-receiving antenna, which was mounted on the top of a variable-height antenna tower.
- c. The antenna height is varied from one meter to four meters above the ground to determine the maximum value of the field strength. Both horizontal and vertical polarizations of the antenna are set to make the measurement.
- d. For each suspected emission, the EUT was arranged to its worst case and then the antenna was tuned to heights from 1 meter to 4 meters and the rota table was turned from 0 degrees to 360 degrees to find the maximum reading.
- e. The test-receiver system was set to Peak Detect Function and Specified Bandwidth with Maximum Hold Mode.
- f. If the emission level of the EUT in peak mode was 10dB lower than the limit specified, then testing could be stopped and the peak values of the EUT would be reported. Otherwise the emissions that did not have 10dB margin would be re-tested one by one using peak, quasi-peak or average method as specified and then reported in a data sheet.
- g. Test the EUT in the lowest channel, the Highest channel

Note:

Both horizontal and vertical antenna polarities were tested and performed pretest to three orthogonal axis. The worst case emissions were reported

3.3.3 DEVIATION FROM TEST STANDARD

No deviation

3.3.4 TEST SETUP

Radiated Emission Test-Up Frequency Above 1GHz

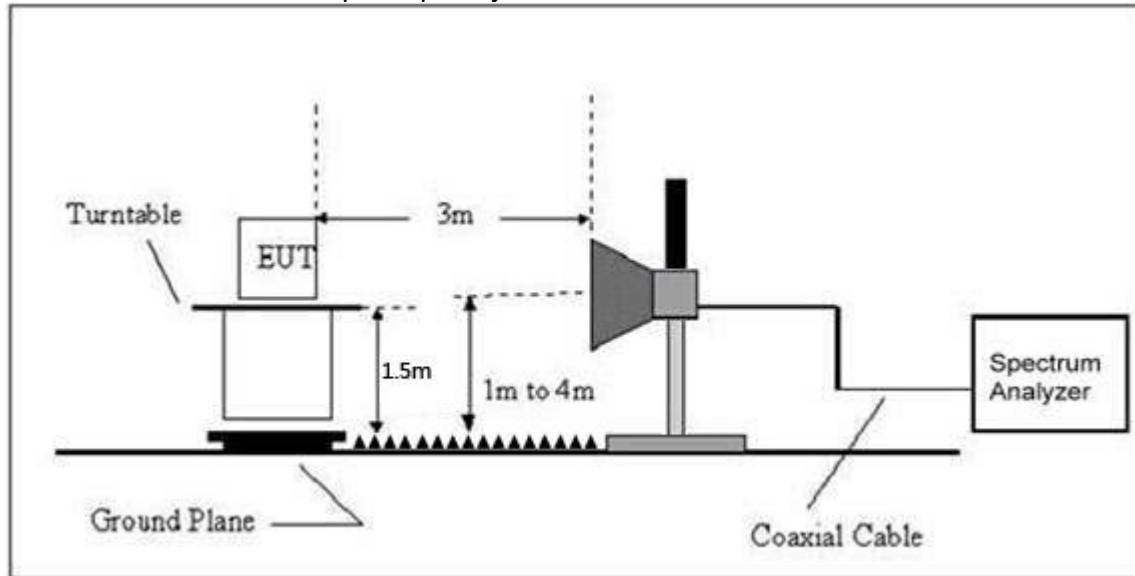

3.3.5 EUT OPERATING CONDITIONS

The EUT tested system was configured as the statements of 2.3 Unless otherwise a special operating condition is specified in the follows during the testing.



3.3.6 TEST RESULT

| | Polar (H/V) | Frequency (MHz) | Meter Reading (dBuV) | Pre-amplifier (dB) | Cable Loss (dB) | Antenna Factor (dB/m) | Emission level (dBuV/m) | Limits (dBuV/m) | | Result |
|--|-----------------------------|-----------------|----------------------|--------------------|-----------------|-----------------------|-------------------------|-----------------|-------|--------|
| | | | | | | | PK | PK | AV | |
| GFSK | Low Channel 2410MHz | | | | | | | | | |
| | H | 2390.00 | 60.80 | 38.06 | 7.42 | 20.15 | 50.31 | 74.00 | 54.00 | PASS |
| | H | 2400.00 | 51.76 | 38.06 | 7.42 | 20.15 | 41.27 | 74.00 | 54.00 | PASS |
| | V | 2390.00 | 62.10 | 38.06 | 7.42 | 20.15 | 51.61 | 74.00 | 54.00 | PASS |
| | V | 2400.00 | 51.45 | 38.06 | 7.42 | 20.15 | 40.96 | 74.00 | 54.00 | PASS |
| | High Channel 2477MHz | | | | | | | | | |
| | H | 2483.50 | 59.14 | 38.17 | 7.45 | 20.54 | 48.96 | 74.00 | 54.00 | PASS |
| | H | 2485.50 | 51.47 | 38.17 | 7.45 | 20.54 | 41.29 | 74.00 | 54.00 | PASS |
| | V | 2483.50 | 60.80 | 38.2 | 7.45 | 20.54 | 50.59 | 74.00 | 54.00 | PASS |
| | V | 2485.50 | 53.66 | 38.2 | 7.45 | 20.54 | 43.45 | 74.00 | 54.00 | PASS |
| Remark: | | | | | | | | | | |
| 1. Emission Level = Meter Reading + Antenna Factor + Cable Loss – Pre-amplifier, Margin= Emission Level - Limit | | | | | | | | | | |
| 2. If the PK measured levels comply with average limit, then the average level were deemed to comply with average limit. | | | | | | | | | | |

4. POWER SPECTRAL DENSITY TEST

4.1 APPLIED PROCEDURES / LIMIT

| FCC Part15 (15.247) , Subpart C | | | | |
|---------------------------------|------------------------|------------------------|-----------------------|--------|
| Section | Test Item | Limit | Frequency Range (MHz) | Result |
| 15.247 | Power Spectral Density | 8 dBm (in any 3KHz) | 2400-2483.5 | PASS |

4.1.1 TEST PROCEDURE

1. Set analyzer center frequency to DTS channel center frequency.
2. Set the span to 1.5 times the DTS bandwidth.
3. Set the RBW to: $3 \text{ kHz} \leq \text{RBW} \leq 100 \text{ kHz}$.
4. Set the VBW $\geq 3 \times \text{RBW}$.
5. Detector = peak.
6. Sweep time = auto couple.
7. Trace mode = max hold.
8. Allow trace to fully stabilize.
9. Use the peak marker function to determine the maximum amplitude level within the RBW.
10. If measured value exceeds limit, reduce RBW (no less than 3 kHz) and repeat.

4.1.2 DEVIATION FROM STANDARD

No deviation.

4.1.3 TEST SETUP



4.1.4 EUT OPERATION CONDITIONS

The EUT tested system was configured as the statements of 2.1 Unless otherwise a special operating condition is specified in the follows during the testing.

Note: Power Spectral Density(dBm)=Reading+Cable Loss



CH10

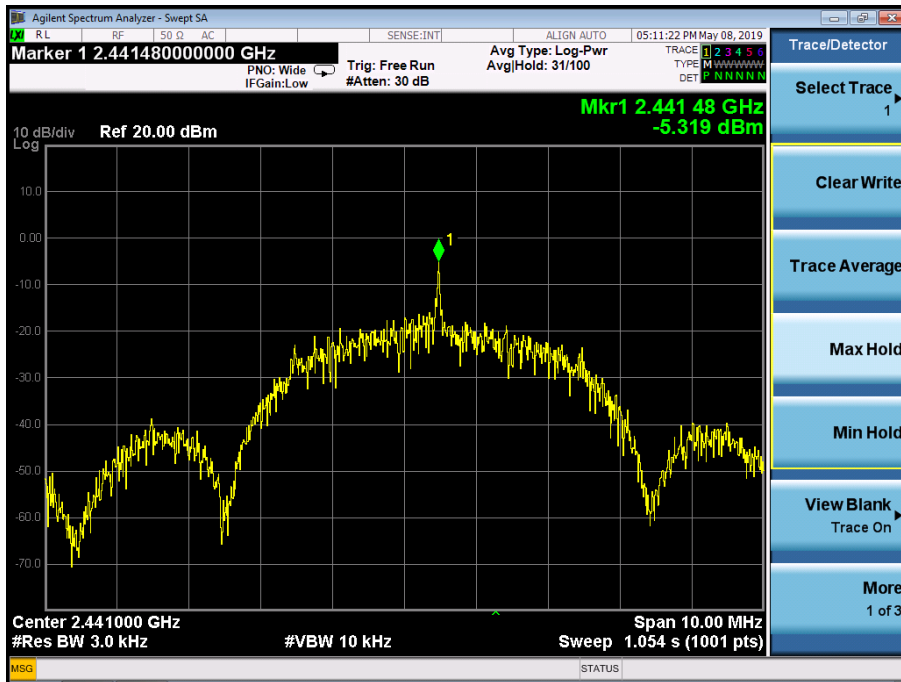

CH20

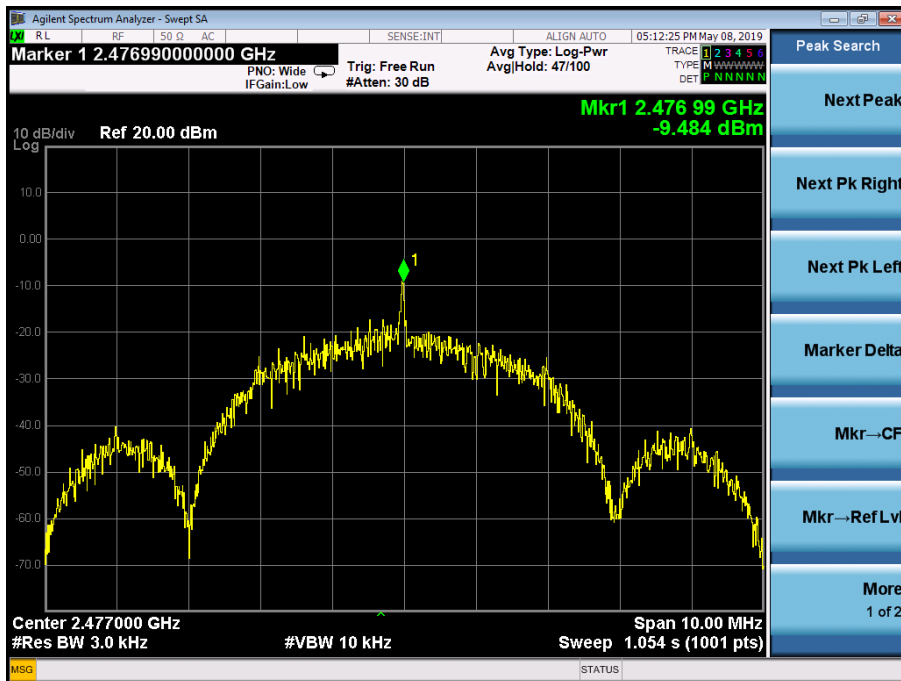

5. BANDWIDTH TEST

5.1 APPLIED PROCEDURES / LIMIT

| FCC Part15 (15.247) , Subpart C | | | | |
|---------------------------------|-----------|---|-----------------------|--------|
| Section | Test Item | Limit | Frequency Range (MHz) | Result |
| 15.247(a)(2) | Bandwidth | $\geq 500\text{KHz}$ (6dB bandwidth) | 2400-2483.5 | PASS |

5.1.1 TEST PROCEDURE

1. Set RBW = 100 kHz.
2. Set the video bandwidth (VBW) $\geq 3 \times$ RBW.
3. Detector = Peak.
4. Trace mode = max hold.
5. Sweep = auto couple.
6. Allow the trace to stabilize.
7. Measure the maximum width of the emission that is constrained by the frequencies associated with the two outermost amplitude points (upper and lower frequencies) that are attenuated by 6 dB relative to the maximum level measured in the fundamental emission.

5.1.2 DEVIATION FROM STANDARD

No deviation.

5.1.3 TEST SETUP

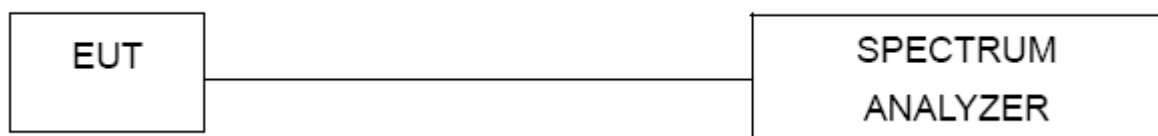

5.1.4 EUT OPERATION CONDITIONS

The EUT tested system was configured as the statements of 2.4 Unless otherwise a special operating condition is specified in the follows during the testing.

5.1.5 TEST RESULTS

| | | | |
|---------------|------|---------------------|-------------------|
| Temperature : | 26°C | Relative Humidity : | 54% |
| Test Mode : | GFSK | Test Voltage : | DC 5V for adapter |

| Frequency (MHz) | 6dB bandwidth (MHz) | Limit (kHz) | Result |
|-----------------|---------------------|-------------|--------|
| 2410 | 1.111 | 500 | Pass |
| 2441.5 | 1.130 | 500 | Pass |
| 2477 | 1.106 | 500 | Pass |

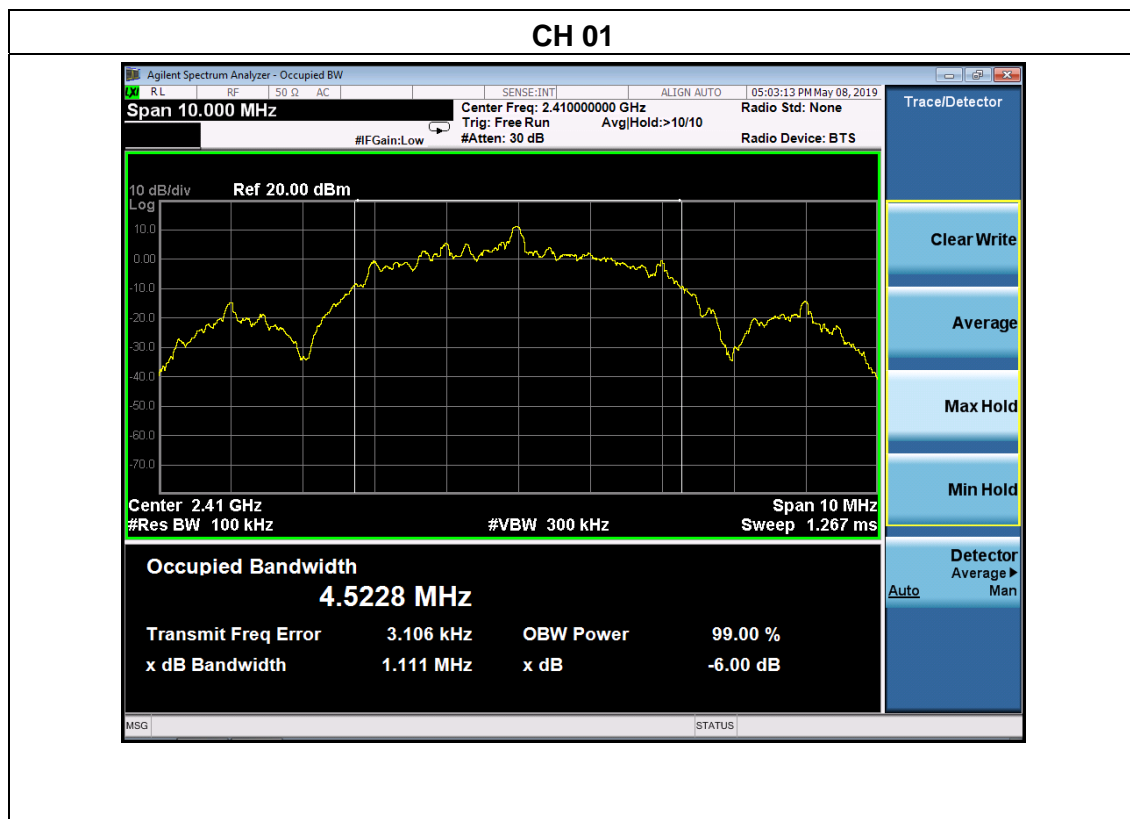



CH10

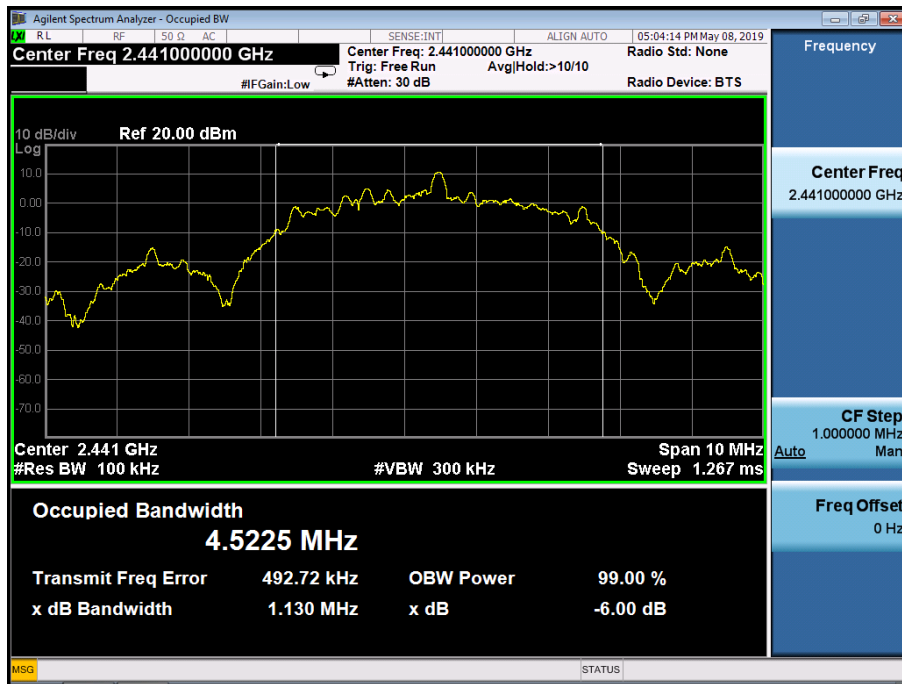

CH20

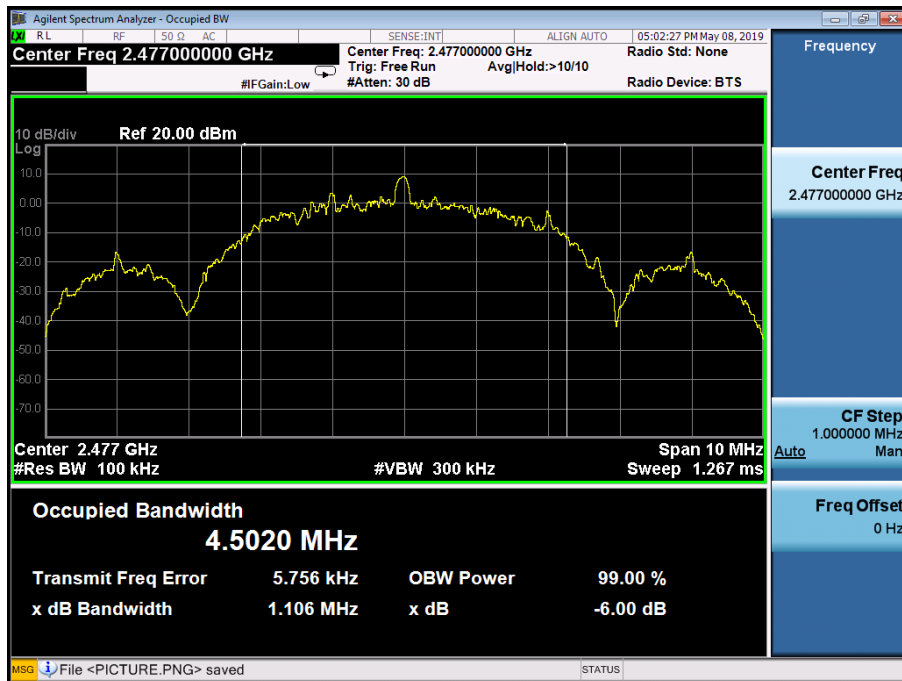



6. PEAK OUTPUT POWER TEST

6.1 APPLIED PROCEDURES / LIMIT

| FCC Part15 (15.247) , Subpart C | | | | |
|---------------------------------|-------------------|-----------------|-----------------------|--------|
| Section | Test Item | Limit | Frequency Range (MHz) | Result |
| 15.247(b)(3) | Peak Output Power | 1 watt or 30dBm | 2400-2483.5 | PASS |

6.1.1 TEST PROCEDURE

- a. The EUT was directly connected to the Power meter

6.1.2 DEVIATION FROM STANDARD

No deviation.

6.1.3 TEST SETUP



6.1.4 EUT OPERATION CONDITIONS

The EUT tested system was configured as the statements of 2.4 Unless otherwise a special operating condition is specified in the follows during the testing.



6.1.5 TEST RESULTS

| | | | |
|----------------|-------------------|---------------------|-----|
| Temperature : | 26℃ | Relative Humidity : | 54% |
| Test Voltage : | DC 5V for adapter | | |

| | Frequency | Maximum Conducted Output Power(PK) | Conducted Output Power Limit |
|------|-----------|---|------------------------------------|
| | (MHz) | (dBm) | dBm |
| GFSK | 2410 | 8.02 | 30 |
| | 2441 | 8.14 | 30 |
| | 2477 | 8.09 | 30 |

7. 100 KHZ BANDWIDTH OF FREQUENCY BAND EDGE

7.1 APPLICABLE STANDARD

In any 100 kHz bandwidth outside the frequency band in which the spread spectrum intentional radiator is operating, the radio frequency power that is produced by the intentional radiator shall be at least 20 dB below that in the 100 kHz bandwidth within the band that contains the highest level of the desired power, based on either an RF conducted or a radiated measurement.

7.2 TEST PROCEDURE

Using the following spectrum analyzer setting:

- a) Set the RBW = 100KHz.
- b) Set the VBW = 300KHz.
- c) Sweep time = auto couple.
- d) Detector function = peak.
- e) Trace mode = max hold.
- f) Allow trace to fully stabilize.

7.3 DEVIATION FROM STANDARD

No deviation.

7.4 TEST SETUP

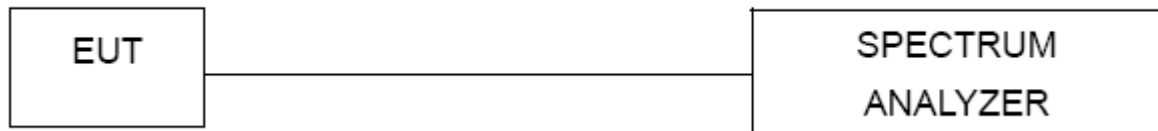

7.5 EUT OPERATION CONDITIONS

The EUT tested system was configured as the statements of 2.4 Unless otherwise a special operating condition is specified in the follows during the testing.

7.6 TEST RESULTS



GFSK: Band Edge, Left Side

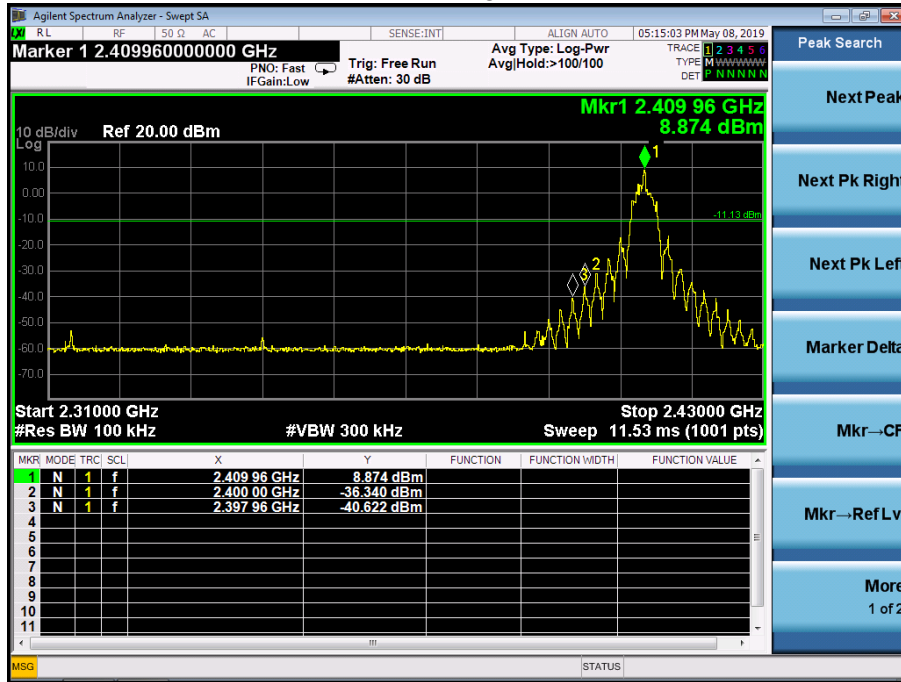

GFSK: Band Edge, Right Side

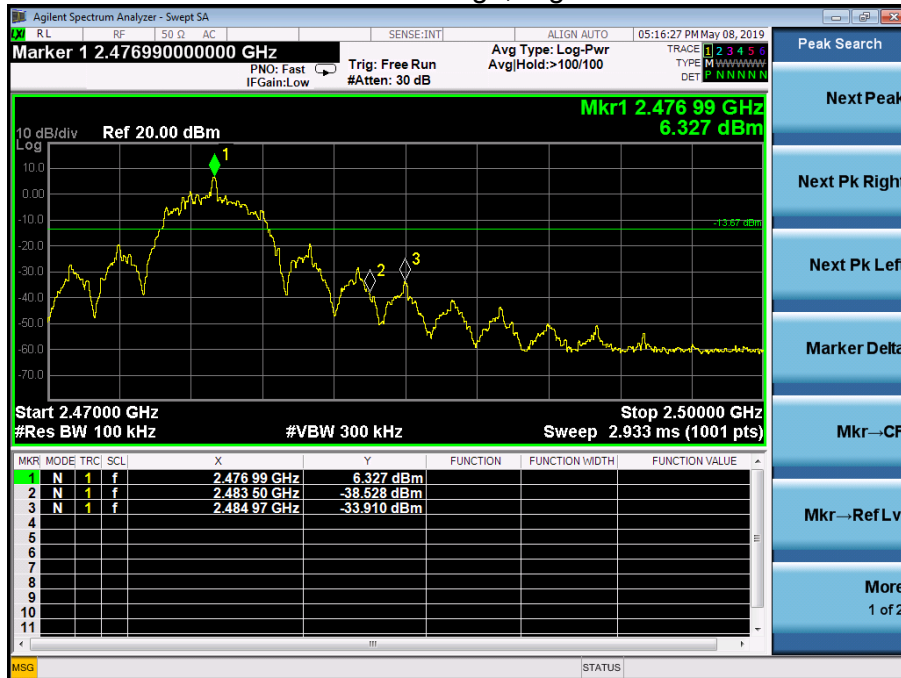



CONDUCTED EMISSION MEASUREMENT

GFSK

Low Channel 2410MHz

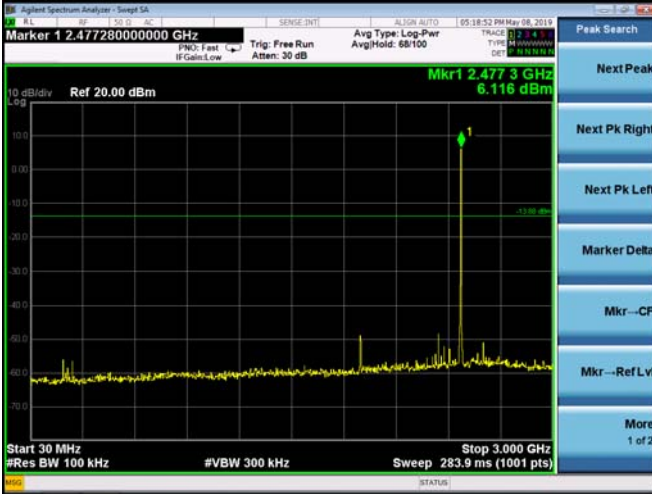

Middle Channel 2441.5MHz

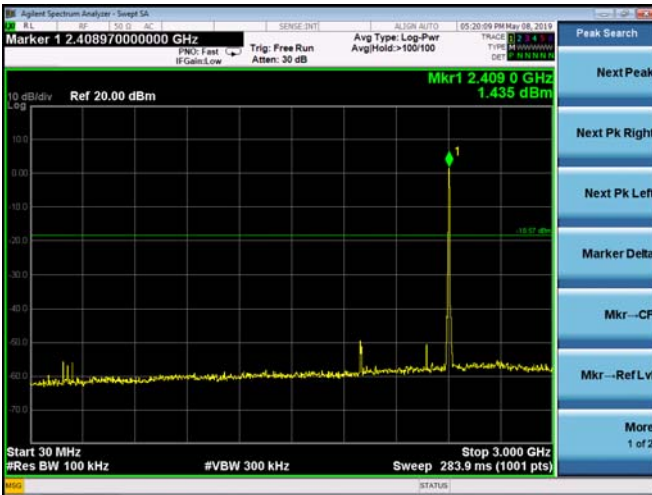

High Channel 2477MHz

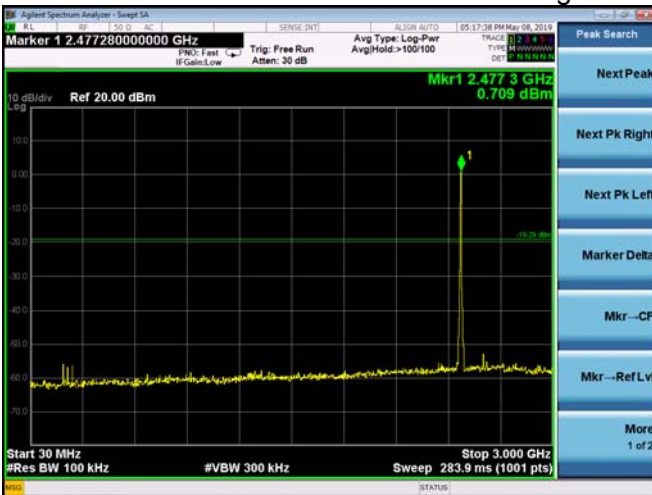

8. ANTENNA REQUIREMENT

8.1 STANDARD REQUIREMENT

15.203 requirement: For intentional device, according to 15.203: an intentional radiator shall be designed to ensure that no antenna other than that furnished by the responsible party shall be used with the device.

8.2 EUT ANTENNA

The EUT antenna is External antenna, fulfill the requirement of this section.



9. EUT TEST PHOTO

Conducted Emission





Radiated Measurement Photos

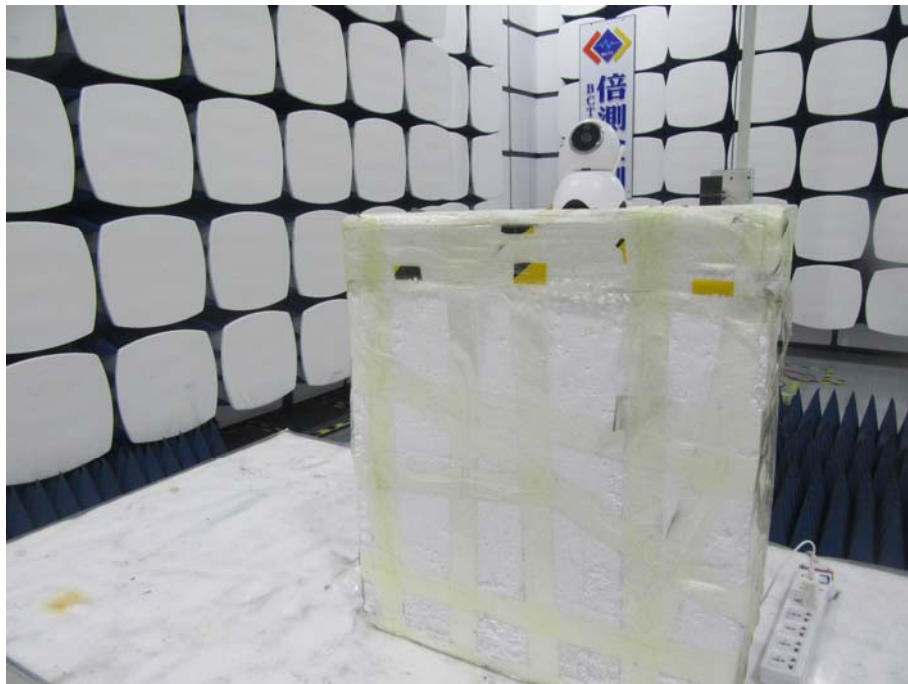



10. EUT PHOTO



***** END OF REPORT *****