

USER MANUAL

4.3" LCD Screen | VIDEO BABY MONITOR

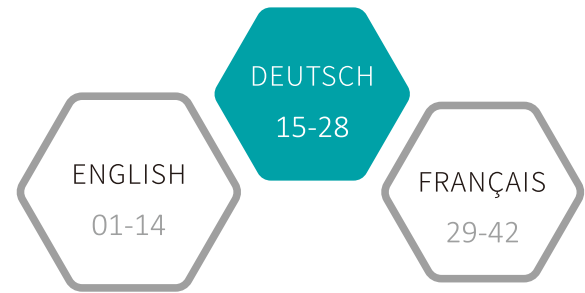

ENGLISH
01-14

DEUTSCH
15-28

FRANÇAIS
29-42

→ ENGLISH







This device complies with part 15 of the FCC Rules. Operation is subject to the following two conditions:
(1) this device may not cause harmful interference, and
(2) this device must accept any interference received, including interference that may cause undesired operation.

WARNING

Incorrect use of the product(s) may lead to safety risks. Therefore, we STRONGLY recommend reading the following instructions before using your product.

1. Keep the cord(s) away from children in case of strangulation (3 feet/ 1 meter away).
2. Put the product(s) in a dry place in case of short-circuit.
3. Use the AC adapter(s) provided by us ONLY. Using unauthorized charging cables and AC adapters may result in overheat even explosion.
4. Unplug the AC adapter(s) if you don't use it(them).
5. Check your baby's activities regularly as this product is not designed for supervision but for assisting your supervising.

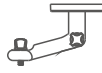
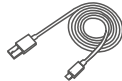
PACKING LIST

Monitor		Camera		
				
				
AC Power Adapter x2	Mount Kit	Camera Mount	Power Cable x2	User Manual

CAMERA

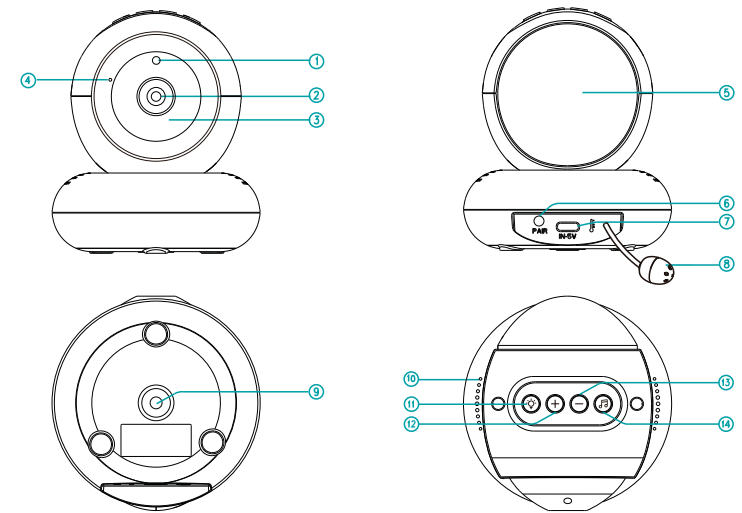

- | | | | |
|------------------------|-----------------------|---------------------|----------------------|
| 1. Night Vision Sensor | 5. LED | 9. Mounting Bracket | 13. - Button |
| 2. Camera Lens | 6. Pair Button | 10. Speaker | 14. Lullabies Button |
| 3. IR LED | 7. Power Input | 11. LED Button | |
| 4. Microphone | 8. Temperature Sensor | 12. + Button | |

MONITOR

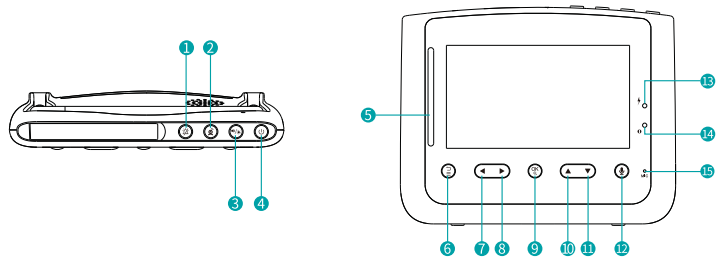

1. **VOX**: The display screen enters the standby state, and the camera detection sound reaches 65dB. The display screen is on for one minute without alarm sound.
2. **Camera Switch**: Switch cameras if connected with 2 or more cameras.
3. **Volume/Brightness**: Press to adjust the monitor's volume or brightness in the monitoring image.
4. **Power/Sleep Button**: Long press to turn on/off the monitor; short press to turn on/off the screen.
5. **Sound Level LED**: Low/high level shows low/high sound detected by the camera.
6. **Menu/Back**: Press to enter menu page or press as a Back button.
7. **Left**: Press to pan the camera leftward or to change your selection leftward.
8. **Right**: Press to pan the camera rightward or to change your selection rightward.
9. **Zoom/OK**: Press to Zoom in/out or to confirm your selection.
10. **Up**: Press to tilt the camera upward or to change your selection upward.
11. **Down**: Press to tilt the camera downward or to change your selection downward.
12. **Talk**: Press to talk to your baby in the monitoring image.
13. **Charging Indicator**: It gives off yellow light while the monitor is being charged.
14. **Power Indicator**: The green light turns on if connected to electricity.
15. **Microphone**

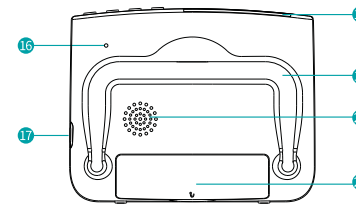

16. **Reset Hole**
17. **Power Input**
18. **Antenna**
19. **Support Stand**
20. **Speaker**
21. **Battery Compartment**

Note:

1. If you **RESET** with a pin, the monitor will be forced shutdown.
2. Do not open the battery compartment without official guidance.

GETTING STARTED

Step 1:

1. Connect the camera to the AC adapter.
2. Plug the AC adapter into a socket.

Note: Put the camera away from your baby (3ft/1m away at least).

Step 2:

1. Connect the monitor to the AC adapter.
2. Plug the AC adapter into a socket.
3. Long press the Power button to turn on the monitor then you can see the monitoring interface.

Note:

The monitor takes about 4 hours to be fully charged, and it lasts about 4-5 hours.

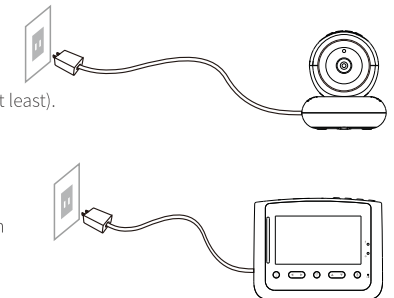



CAMERA SETTING

Notice:

The camera and monitor were paired already. This function is to add new cameras to the monitor.



1. Add cameras

Step 1:

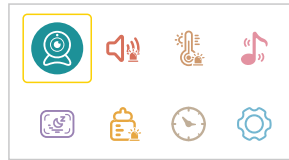
1. Press  to enter menu page.
2. Choose  and press  button.



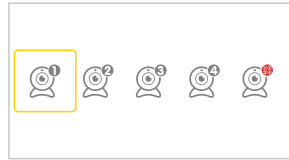

Step 2:

1. Select  then press  button.



Step 3:

1. Select  and press  button TWICE.
See Camera is NOT paired.
2. Press  button to start pairing.

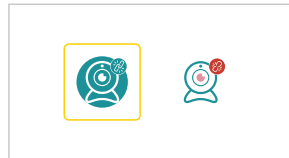

Step 4:

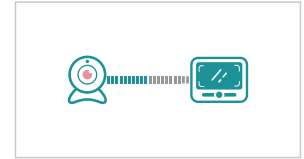

1. Press  PAIR button on the back of the camera.
2. Then see the prompted Paired.

Note: Four cameras at most can be connected to one monitor.



2. Delete cameras

Step 1:

1. Press  to enter menu page.
Choose  and press .



2. Select the camera need deleting.
Press .

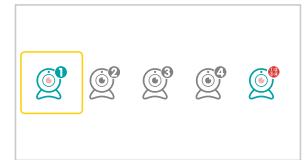

Step 2:

1. Select the right camera icon. Press  TWICE.

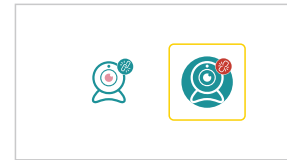

2. See Deleted. Your camera is deleted.

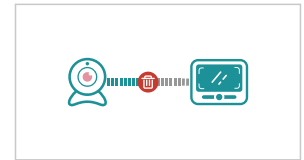

SOUND DETECTION

Explanation:

There are four options of sound detection, I (78dB), II (65dB) and III (60dB). I means the sound can be detected if it reached 78dB, and so on for II and III.

Step 1:

1. Press  to enter menu page. Choose  and press .

2. Select the option you want. Press .

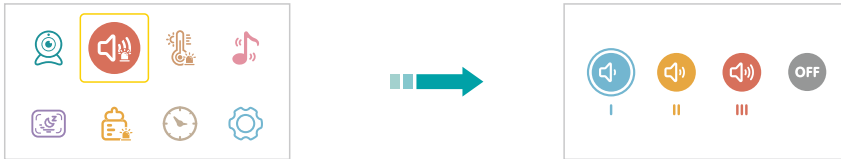

TEMPERATURE ALARM

Explanation:

 indicates that the temperature value for high and low temperature alarms can be set.

Step 1:

1. Press  to enter menu page. Choose  and press .

2. Select the option you want. Press .



Note: A sound/temperature alarm can be temporarily turned off by pressing any button on the monitor.

LULLABIES

Explanation:

This function is to comfort your baby when needed.

Step 1:

1. Press  to enter menu page.

Choose  and press .

2. Select the lullaby you want.

Select ALL to play the lullabies in a loop.

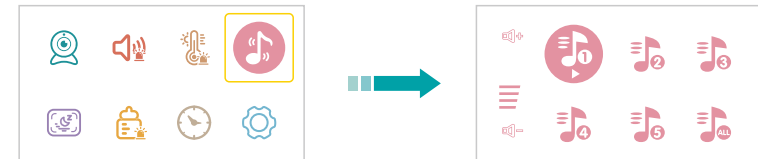

SLEEP MODE

Explanation:

This function is to prolong your monitor's runtime by shutting down the screen.

Step 1:

1. Press  to enter menu page.

Choose  and press .

2. Select the time you want.

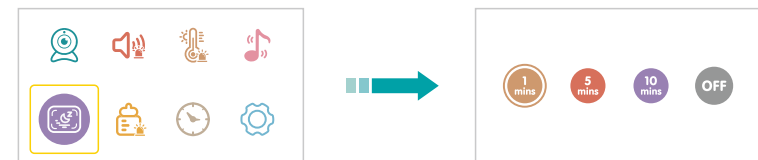

Note: The screen will automatically light up if there is a sound alarm or a temperature alarm.

FEEDING

Explanation:

This function is to remind you of feeding your baby. **OFF** means you shut down the function; **2.5 hour** means it reminds you every 2.5 hours and so on for the other options.

Step 1:

1. Press  to enter menu page.
Choose  and press .

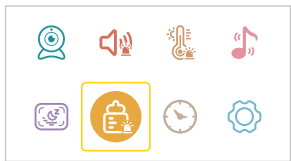

2. Select the time you want.
Select **OFF** to turn off the feeding reminder.



Note: Selecting  will set the alarm to the specified time.

DATE/TIME



Explanation:

This function is to set Date/Time, turn on/off .

Step 1:

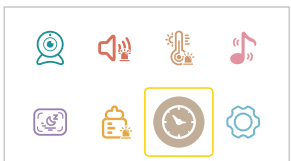
1. Press  to enter menu page.
Choose  and press .



2. Press  to start/finish setting.
 stands for starting the setting.

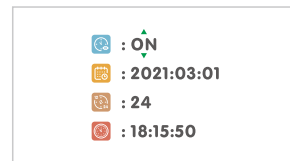

3.  stands for finishing the setting.

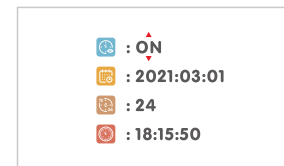

Note:

* Press Up/Down/Left/Right to select and press  button to confirm.

* If  is ON, the date and time will be displayed on the status bar of the monitor; otherwise, it will not be displayed.

SETTINGS



Explanation:

Restore factory settings and provide service support information.

Step 1:

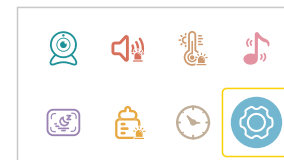
1. Press  to enter menu page.
Choose  and press .



2. Select and conform .
Press  to enter the interface.

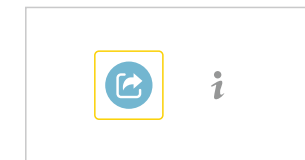

3. Conform YES to reset.

Press  or conform NO to exit.

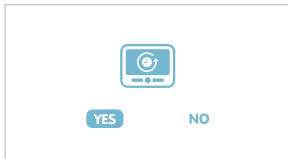

1. Select .



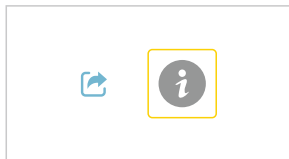









Press  to enter the interface.







RX:XXXXXXX
TX:XXXXXXX

ICONS EXPLANATION



1. Status Bar Icons

-  : No signal connection
-  : Signal strength
-  : Live video loop
-  : Lullabies enabled
-  : Sleep Mode enabled
-  : Current room temperature
-  : Battery Level
-  : Sound detection enabled
-  : Temperature alarm enabled
-  : Feeding reminder enabled
-  : 2 times magnification
-  : 4 times magnification
-  : Night mode
- VOX** : VOX mode is on

2. Notifications Icons

-  : No camera connected
-  : Sound Alarm
-  : Temperature Alarm
-  : Feeding Notification

Explanation:

You can open Live-Video-Loop function through short presses on the  button until you see  on the status bar. When Live-Video-Loop function is on, the connected cameras will automatically switch every 10 seconds. And if there is a sound/temperature alarm, the camera-switch function will pause temporarily.

FAQ

Q1. Why did I fail to connect the camera to the monitor?

- * Make sure to plug the power adapter into the camera and socket firmly.
- * Make sure the camera and the monitor is within the effective distance.

Q2. Why is the live video so blurry?

- * Make sure there is no obstacle on the lens of the camera.

Q3. Why did the monitor make noise?

- * The camera and monitor may be too close. Put them further apart.

Q4. Can I hear my baby when I turn off the screen?

- * Yes. You should turn on Sound Detection, and it will wake up the screen and make a sound alarm if a loud sound is detected.

Q5. Why is the picture black and white?

- * The Night Vision Mode will be activated if the camera worked in a dark environment (Brightness \leq 5 Lux).







→ DEUTSCH

SICHERHEITSHINWEISE

Die falsche Verwendung des Produkt kann zu Sicherheitsrisiken führen. Derum empfehlen Sie wir DRINGEND, die folgenden Anweisungen lesen, bevor Sie verwenden.

1. Halten Sie Kabel im Falle einer Strangulation von Kindern fern (3 Fuß / 1 Meter).
2. Legen Sie das / die Produkt (e) bei Kurzschluss an einen trockenen Ort.
3. Verwenden Sie AC-Adapter NUR gelieferten von uns. Die Verwendung von nicht zugelassenen Ladekabeln und Gleichstromadaptern kann zu Überhitzung und Explosion führen.
4. Ziehen Sie den AC-Adapter heraus, wenn Sie nicht verwenden.
5. Überprüfen Sie regelmäßig die Aktivitäten Ihres Babys, da dieses Produkt nicht für die Überwachung vorgesehen ist, sondern Sie bei der Überwachung unterstützt.

INHALT

Monitor		Kamera		
				
				
AC Adapter x2	Montagesatz	Kamerahalterun	Stromkabel x2	Bedienungsanleitung

KAMERA

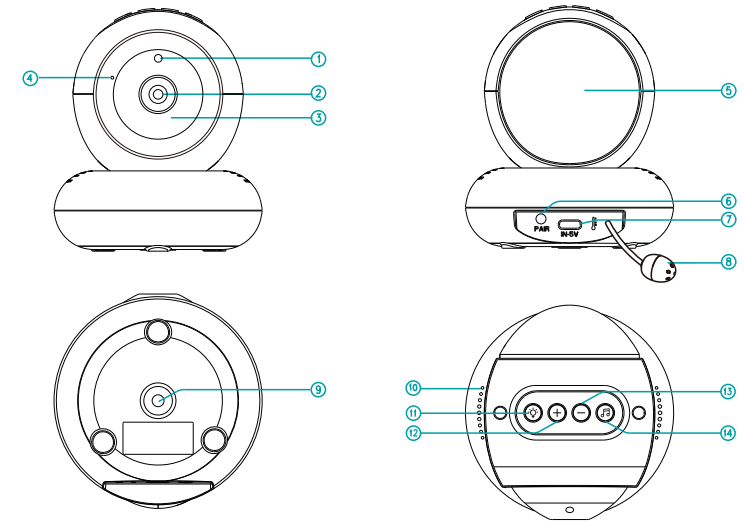

- | | | | |
|---------------------|----------------------|------------------|------------------------|
| 1. Nachtsichtsensor | 5. LED | 9. Montageloch | 13. - Taste |
| 2. Kameralinsen | 6. Pair Taste | 10. Lautsprecher | 14. Schlaflieder Taste |
| 3. IR LED | 7. Leistungsaufnahme | 11. LED Taste | |
| 4. Mikrofon | 8. Temperatur Sensor | 12. + Taste | |

MONITOR

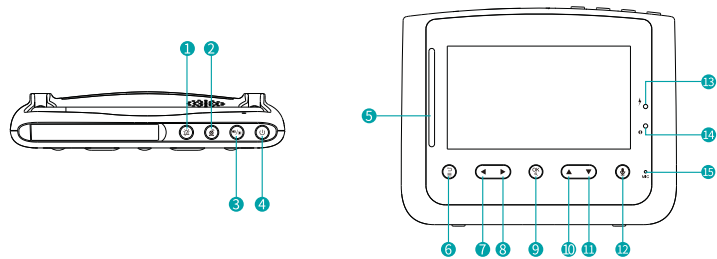

1. **VOX**: Der Bildschirm wechselt in den Standby-Zustand und die Kamera erkennt, dass der Ton 65 dB erreicht. Der Bildschirm ist eine Minute lang eingeschaltet und es liegt kein Alarm vor.
2. **Kameraschalter**: Wechselt die Kamera, wenn zwei oder mehr Kameras angeschlossen sind.
3. **Lautstärke/Helligkeit**: Drücken Sie diese Taste, um die Lautstärke oder Helligkeit des Monitors im Überwachungsbild anzupassen.
4. **Power/Sleep-Taste**: Lang drücken, um den Monitor ein- oder auszuschalten. kurz drücken, um den Bildschirm ein- /auszuschalten.
5. **Schallpegel-LED**: Niedriger/hoher Pegel zeigt den von der Kamera erkannten niedrigen/hohen Ton an.
6. **Menü/Zurück**: Drücken Sie diese Taste, um die Menüseite aufzurufen, oder drücken Sie sie als Zurück-Taste.
7. **Links**: Drücken Sie diese Taste, um die Kamera nach links zu schwenken oder Ihre Auswahl nach links zu ändern.
8. **Rechts**: Drücken Sie diese Taste, um die Kamera nach rechts zu schwenken oder Ihre Auswahl nach rechts zu ändern.
9. **Zoom/OK**: Drücken Sie diese Taste, um die Ansicht zu vergrößern/zu verkleinern oder um Ihre Auswahl zu bestätigen.
10. **Nach oben**: Drücken Sie diese Taste, um die Kamera nach oben zu neigen oder Ihre Auswahl nach oben zu ändern.
11. **Nach unten**: Drücken Sie diese Taste, um die Kamera nach unten zu neigen oder Ihre Auswahl nach unten zu ändern.
12. **Sprechen**: Drücken Sie, um mit Ihrem Baby im Überwachungsbild zu sprechen.
13. **Ladeanzeige**: Sie leuchtet gelb, während der Monitor geladen wird.
14. **Stromanzeige**: Das grüne Licht leuchtet auf, wenn Strom angeschlossen ist.
15. **Mikrofon**

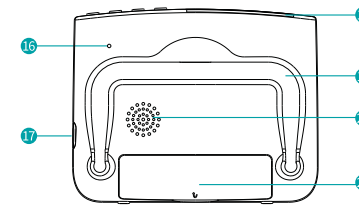

16. Bohrung zurücksetzen
17. Leistungsaufnahme
18. Antenne
19. Ständer
20. Sprecher
21. Batteriefach

Hinweise :

1. Wenn Sie den **RESET** Knopf drücken, wird das Herunterfahren des Monitors erzwungen.
2. Öffnen Sie das Batteriefach nicht ohne offizielle Anleitung.

AUFLADEN

Schritt 1:

1. Schließen Sie die Kamera an den Gleichstrom Adapter an.
2. Stecken Sie den AC-Adapter in eine Steckdose.

Hinweis: Stellen Sie die Kamera nicht in der Nähe Ihres Babys auf (mindestens 1 m Abstand).

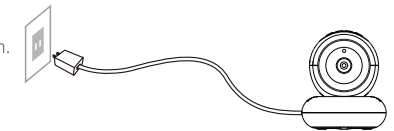

Schritt 2:

1. Schließen Sie den Monitor an den Gleichstromadapter an.
2. Stecken Sie den AC-Adapter in eine Steckdose.
3. Halten Sie die Ein-/Aus-Taste lange gedrückt um den Monitor anzuschalten und das zu überwachende Areal zu sehen.

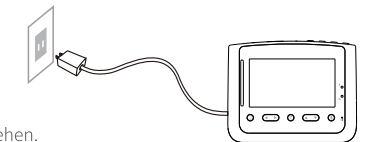

Hinweis: Das vollständige Aufladen des Monitors dauert 4 Stunden. Und es hält ungefähr 4 - 5 Stunden.



KAMERA EINSTELLUNGEN

Beachte:

Die Kamera und der Monitor waren bereits gekoppelt. Diese Funktion dient zum Hinzufügen neuer Kameras zum Monitor.

1. Fügen Sie Kameras hinzu

Schritt 1:

1. Drücken Sie , um die Menüseite aufzurufen.
2. Wählen Sie  und drücken Sie die **OK**-Taste.

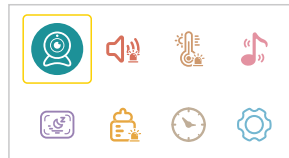

Schritt 2:

1. Wählen Sie  und drücken Sie die Taste **OK**.

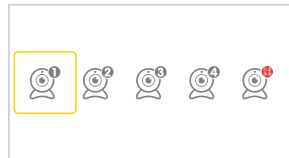

Schritt 3:

1. Wählen Sie  und drücken Sie die **OK**-Taste.
Siehe **Kamera ist nicht gekoppelt**.
2. Drücken Sie die **OK**-Taste, um die Kopplung zu starten.

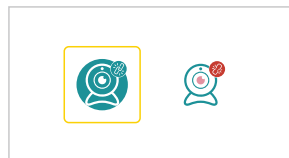

Schritt 4:

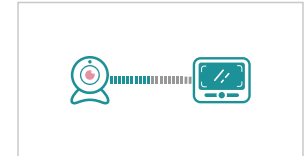

1. Drücken Sie die -Taste am Rückseite der Kamera.
2. Dann sehen Sie die Aufforderung **Die Kopplung ist Ok**.

Hinweis: Maximal vier Kameras können an einen Monitor angeschlossen werden.



2. Lösche Kameras

Schritt 1:

1.  drücken, um die Menüseite aufzurufen.
Wählen Sie  und drücken Sie **OK**.

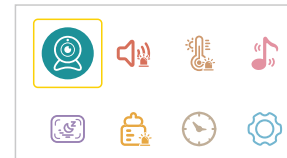

2. Wählen Sie die zu löschende Kamera aus.
Drücke **OK**.

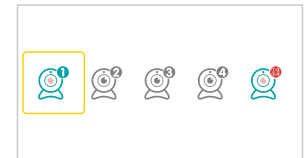

Schritt 2:

1. Wählen Sie das rechte Kamerasymbol.
Drücken Sie zweimal **OK**.

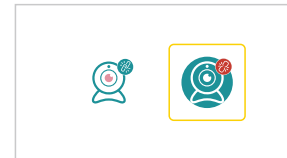

2. Siehe **Das Löschen ist OK**.
Ihre Kamera wird gelöscht.

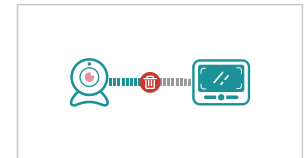



GERÄUSCHERKENNUNG

Erläuterung:

Es gibt vier Optionen für die Tonerkennung: I (78 dB), II (65 dB) und III (60 dB). I bedeutet, dass der Ton erkannt werden kann, wenn er 78 dB erreicht, und so weiter für II und III.

Schritt 1:

1. Drücken Sie , um die Menüseite aufzurufen.
Wählen Sie  und drücken Sie .

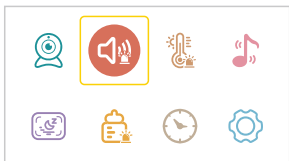

2. Wählen Sie die gewünschte Option.
Drücken Sie .

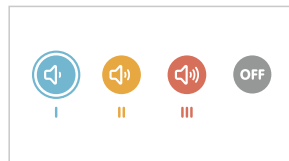



TEMPERURALARM

Erläuterung:

 zeigt an, dass der Temperaturwert für Alarme bei hohen und niedrigen Temperaturen eingestellt werden kann.

Schritt 1:

1. Drücken Sie , um die Menüseite aufzurufen.
Wählen Sie  und drücken Sie .

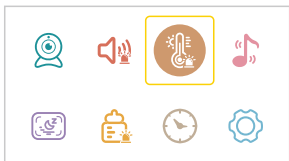

2. Gewünschte Einheit auswählen und bestätigen.
ON/OFF bedeutet Öffnen/Schließen des Alarms.

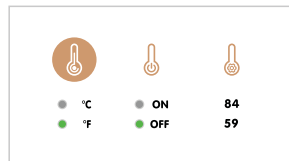



Hinweis: Eine Alarmmeldung kann vorübergehend durch das Drücken einer beliebigen Taste des Monitors ausgeschaltet werden.

SCHLAFLIEDER

Erklärung:

Diese Funktion soll Ihr Baby bei Bedarf trösten.

Schritt 1:

1. Drücken Sie , um die Menüseite aufzurufen.
Wählen Sie  und drücken Sie .

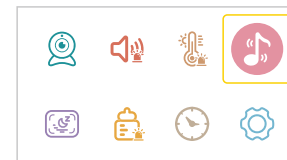

2. Wählen Sie das gewünschte Wiegelied aus.
Wählen Sie ALL, um das Schlaflied in einer Schleife abzuspielen.

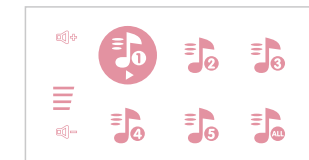

SCHLAFMODUS

Erläuterung:

Mit dieser Funktion können Sie die Laufzeit Ihres Monitors verlängern, indem Sie den Bildschirm herunterfahren.

Schritt 1:

1. Drücken Sie , um die Menüseite aufzurufen.
Wählen Sie  und drücken Sie .

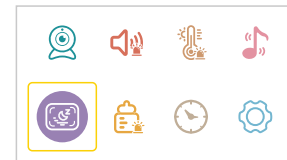



Hinweis: Der Bildschirm leuchtet automatisch auf, wenn ein akustischer Alarm oder ein Temperaturalarm vorliegt.

FÜTTERUNGSERINNERUNG

Erläuterung:

Diese Funktion soll Sie an das Stillen Ihres Babys erinnern. **OFF** bedeutet, dass Sie die Funktion beendet haben. **2,5 Stunden** bedeutet, dass Sie alle 2,5 Stunden daran erinnert werden, usw. für die anderen Optionen.

Schritt 1:

1. Drücken Sie , um die Menüseite aufzurufen.
Wählen Sie  und drücken Sie .
2. Wählen Sie die gewünschte Zeit. Wählen Sie **OFF**, um die Fütterungserinnerung auszuschalten.

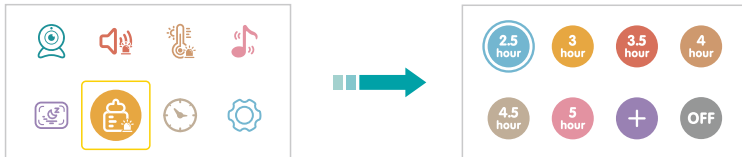





Hinweis: Wählen Sie , um den Alarm auf die angegebene Zeit einzustellen.

DATUM/UHRZEIT

Erläuterung:

Mit dieser Funktion können Sie Datum und Uhrzeit einstellen, das  ein- und ausschalten.

Schritt 1:

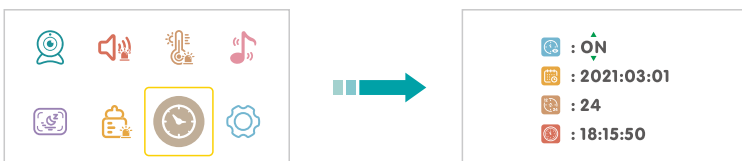

1. Drücken Sie , um die Menüseite aufzurufen.
Wählen Sie  und drücken Sie .
2. Drücken Sie , um die Einstellung zu starten/zu beenden.  steht für das Starten der Einstellung.

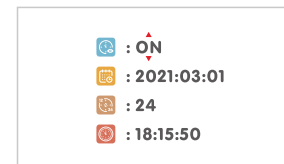

3.  steht für das Beenden der Einstellung.



Hinweis:



- * Wählen Sie mit **Auf/Ab/Links/Rechts** die Option aus und drücken Sie zur Bestätigung die Taste .
- * Wenn  aktiviert ist, werden Datum und Uhrzeit in der Statusleiste des Monitors angezeigt. Andernfalls wird es nicht angezeigt.

EINSTELLUNGEN

Erläuterung:

Die Werkseinstellungen wiederherstellen und Geben Sie Informationen zum Service-Support an.

Schritt 1:

1. Drücken Sie , um die Menüseite aufzurufen.
Wählen Sie  und drücken Sie .
2. Auswählen und anpassen 
Drücken Sie , um die Schnittstelle aufzurufen.

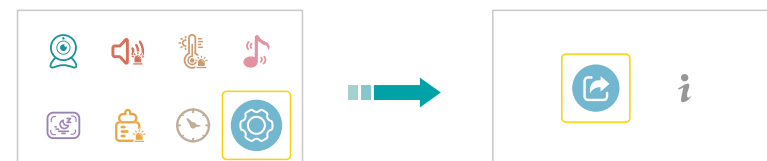

2. Zum Zurücksetzen YES bestätigen.

 drücken oder NO bestätigen, um den Vorgang zu beenden.

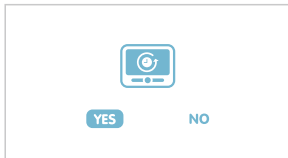





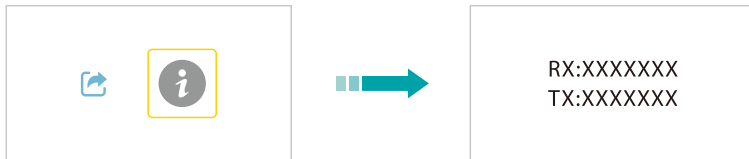







1. Wählen Sie .

Drücken Sie , um die Schnittstelle aufzurufen.







SYMBOLERLÄUTERUNGEN



1. Statusleistsensymbole

-  : Keine Signalverbindung
-  : Signalstärke
-  : Live-Video-Loop
-  : Schlaflieder aktiviert
-  : Schlafmodus aktiviert
-  : Aktuelle Raumtemperatur
-  : Batterie Level
-  : Sounderkennung aktiviert
-  : Temperaturalarm aktiviert
-  : Fütterungserinnerung aktiviert
-  : 2-fache Vergrößerung
-  : 4-fache Vergrößerung
-  : Nacht-Modus
-  : Der VOX-Modus ist aktiviert

2. Benachrichtigungssymbole

-  : Keine Kamera angeschlossen
-  : Ton Alarm
-  : Temperaturalarm
-  : Fütterungsbenechtigung

Erklärung:

Sie können die Live-Video-Loop Funktion mit Hilfe kurzen Drückens der  Taste einschalten bis Sie  in der Statusleiste sehen können. Wenn die Live-Video-Loop Funktion aktiviert ist, werden die damit verbundenen Kameras automatisch im 10 Sekunden Takt wechseln und Ihnen die Aufnahmen übertragen. Sollte es eine Alarmmeldung geben, wird der Kamerawechsel vorübergehend eingestellt.

FAQ

Q1. Warum verbindet sich die Kamera nicht mit dem Monitor?

- * Vergewissern Sie sich das der Stecker fest in der Kamera und dem Netzteil steckt.
- * Vergewissern Sie sich, dass die Kamera und der Monitor die richtige Entfernung haben.

Q2. Warum ist das Live Video verschwommen?

- * Vergewissern Sie sich das nichts vor den Linsen oder vor der Kamera steht.

Q3. Warum macht der Monitor Geräusche?

- * Die Kamera und der Monitor steht zu nah nebeneinander. Stellen Sie beide weiter auseinander.

Q4. Kann ich mein Baby hören, wenn ich den Bildschirm ausschalte?

- * Ja. Sie sollten die Geräuscherkennung aktivieren. Sie weckt den Bildschirm und gibt einen akustischen Alarm aus, wenn ein lautes Geräusch erkannt wird.

Q5. Warum ist das Bild schwarz - weiss?

- * Der Nachtsichtmodus schaltet sich ein, wenn die Kamera in einer dunklen Umgebung an ist. (Helligkeit ≤ 5 Lux)







→ FRANÇAIS

ATTENTION

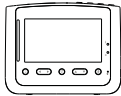
L'utilisation incorrecte du produit peut entraîner des risques en sécurité. Nous vous recommandons VIVEMENT de lire les instructions ci-dessous avant votre utilisation.

1. Gardez le(s) corde(s) hors de portée des enfants en cas de strangulation (à 3 pieds ou 1 mètre).
2. Placez le (s) produit (s) dans un endroit sec en cas de court-circuit.
3. Utilisez UNIQUEMENT le(s) adaptateur(s) fourni(s) par nous. L'utilisation de câbles de charge et d'adaptateurs non autorisés peut entraîner une surchauffe, voire une explosion.
4. Débranchez le(s) adaptateur(s), si vous ne le(s) utilisez pas.
5. Faites attention régulièrement aux activités de votre bébé, car le produit n'est pas conçu pour la surveillance, mais pour vous aider en surveillance.

LISTE DE PAQUET

Moniteur		Caméra		
				
				
Adaptateurs AC x2	Accessoire de support	Support de caméra	Câble d'alimentation x2	Mode d'emploi

CAMERA

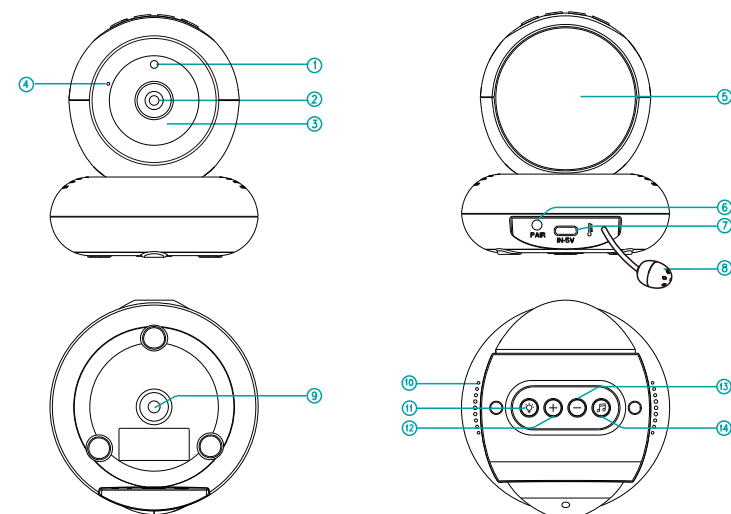

- | | | | |
|-------------------------------|---------------------------|------------------------|---------------------|
| 1. Capteur de vision nocturne | 5. LED | 9. Support de fixation | 13. Bouton - |
| 2. La lentille de la caméra | 6. Bouton appariement | 10. Parleur | 14. Bouton Berceuse |
| 3. IR LED | 7. L'entrée de courant | 11. Bouton LED | |
| 4. Microphone | 8. Capteur de température | 12. Bouton + | |

MONITEUR

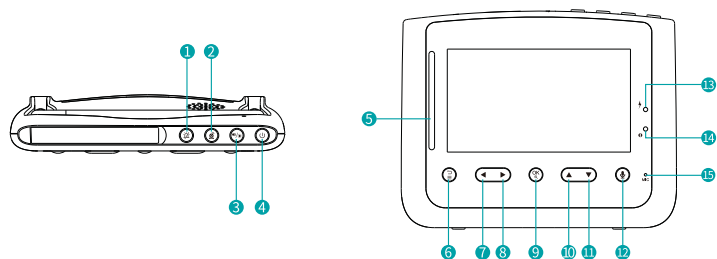

1. **VOX**: L'écran d'affichage entre en état de veille et la caméra détecte que le son atteint 65 dB. L'écran d'affichage est allumé pendant une minute et il n'y a pas d'alarme.
2. **Commutateur de caméra**: Commutez les caméras s'il y a 2 caméras ou plus.
3. **Volume / Lumiosité**: Appuyez pour régler le volume ou la luminosité de l'affichage du moniteur.
4. **Bouton d'alimentation / veille**: Appui long pour allumer/éteindre le moniteur; appuyez brièvement pour allumer / éteindre l'écran.
5. **LED qui indique le niveau sonore**: Le niveau bas / haut indique le son faible/élevé détecté par la caméra.
6. **Menu / Retour**: Appuyez sur le bouton pour entrer la page de menu ou pour retourner au dernier page.
7. **Gauche**: Appuyez pour incliner la caméra à gauche ou pour changer le choix à gauche.
8. **Droite**: Appuyez pour incliner la caméra ou pour changer votre sélection vers la droite.
9. **Zoom / OK**: Appuyez pour effectuer un zoom avant ou arrière ou pour confirmer votre sélection.
10. **Haut**: Appuyez pour incliner la caméra vers le haut ou pour changer votre sélection vers le haut.
11. **Bas**: Appuyez pour incliner la caméra vers le bas ou pour changer votre sélection vers le bas.
12. **Parler**: Appuyez pour parler à votre bébé dans l'image de surveillance.
13. **Indicateur de charge**: Il émet une lumière jaune pendant le chargement du moniteur.
14. **Indicateur d'alimentation**: Le voyant vert s'allume s'il est connecté à l'électricité.
15. **Microphone**

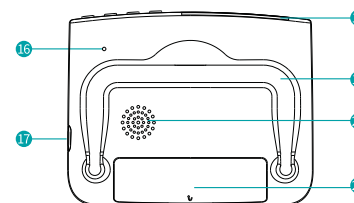

16. Le trou de la remise
17. Entrée de courant
18. Antenne
19. Support
20. Parleur
21. Compartiment de la batterie.

Remarques:

1. Si vous appuyez sur **RESET** avec une broche, le moniteur pourra être éteint par force.
2. Il est interdit d'ouvrir le compartiment de cellule sans instruction officielle.

CHARGEMENT

Étape 1:

1. Connectez la caméra à l'adaptateur.
2. Branchez l'adaptateur AC dans une prise.

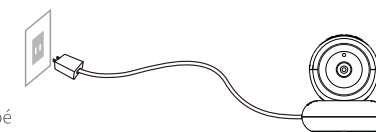

Remarque: Éloignez la caméra hors de portée de votre bébé (au moins de 3ft / 1 mètre).

Étape 2:

1. Connectez le moniteur à l'adaptateur AC.
2. Branchez l'adaptateur AC dans une prise.
3. Cliquez sur le bouton d'alimentation pour démarrer le moniteur et voir l'interface de surveillance.

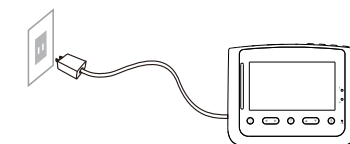

Remarque: Le moniteur prend 4 heures pour être complètement chargé. Et cela dure environ 4 à 5 heures.



RÉGLAGE DE LA CAMÉRA

A remarquer:

La caméra et le moniteur ont été déjà appariés. Cette fonction consiste à rajouter de nouvelles caméras sur le moniteur.

1. Ajouter des caméras

Étape 1:

1. Appuyez sur  pour accéder à la page du menu.
2. Choisissez  et appuyez sur le bouton .

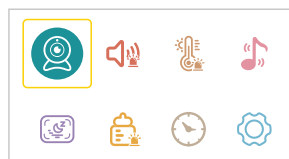

Étape 2:

1. Sélectionnez  puis appuyez sur le bouton .

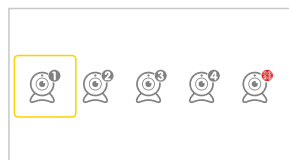

Étape 3:

1. Sélectionnez  et appuyez sur le bouton . **Caméra n'est pas connectée** s'affiche.
2. Appuyez sur le bouton  pour commencer l'appariement.

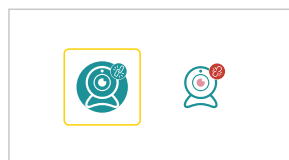

Étape 4:

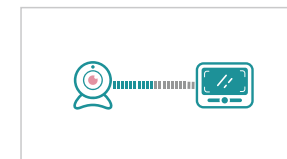

1. Appuyez sur le bouton  de l'arrière de la caméra.
2. Puis **Connexion OK** s'affiche.

Remarque: Quatre caméras au maximum peuvent être connectées à un moniteur.



2. Supprimer les caméras

Étape 1:

1. Appuyez sur  pour accéder à la page du menu. Choisissez  et appuyez sur .

2. Sélectionnez la caméra à supprimer et appuyez sur .

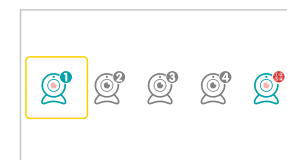
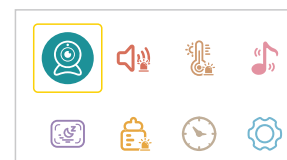

Étape 2:

1. Sélectionnez l'icône de caméra. Appuyez sur  DEUX fois.

2. **Effacement est OK** s'affiche. Votre caméra a été supprimée.

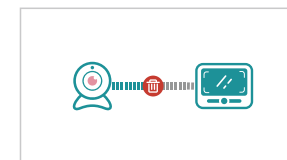
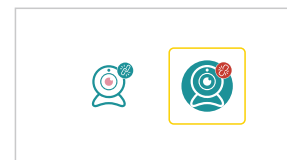



DÉTECTION SONORE

Explication:

Il existe quatre options de détection du son, à savoir I (78 dB), II (65dB) et III (60dB). I signifie que le son peut être détecté s'il atteint 78dB, et ainsi de suite pour II et III.

Etape 1:

1. Appuyez sur  pour accéder à la page de menu.

Choisissezz  et appuyez sur .



2. Sélectionnez l'option vous voulez.

Appuyez sur .

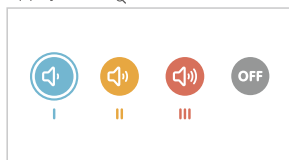



ALARME DE TEMPÉRATURE

Explication:

 indique que la valeur de température pour les alarmes de haute et basse température peut être réglée.

Etape 1:

1. Appuyez sur  pour accéder à la page de menu.

Choisissezz  et appuyez sur .

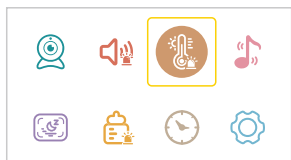

2. Sélectionnez et confirmez l'unité souhaitée.

ON/OFF signe démarrer / fermer l'alarme.

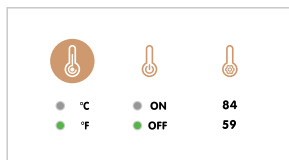

Remarque: En appuyant sur n'importe quel bouton du moniteur, la détection sonore / de température peut être temporairement désactivée.

BERCEUSE

Explication:

Cette fonction a pour but de réconforter votre bébé en cas de besoin.

Etape 1:

1. Appuyez sur  pour accéder à la page de menu.

Choisissezz  et appuyez sur .

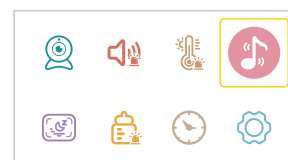

2. Sélectionnez la berceuse que vous désirez

Sélectionnez **ALL** pour démarrer toutes les berceuses.

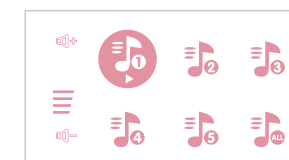

MODE VEILLE

Explication:

Cette fonction permet de prolonger la durée d'exécution de votre moniteur en éteignant l'écran.

Etape 1:

1. Appuyez sur  pour accéder à la page de menu.

Choisissezz  et appuyez sur .

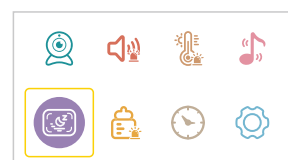

2. Sélectionnez le temps que vous désirez

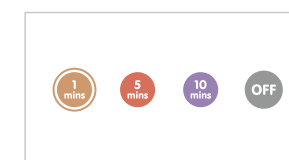

Remarque: L'écran s'allumera automatiquement s'il y a une alarme sonore ou une alarme de température.

Minuterie d'Alimentation

Explication:

Cette fonction a pour objet de vous rappeler de nourrir votre bébé. « Fermer » signifie éteindre la fonction. « 2,5 heures » signifie le rappel une fois toutes les 2,5 heures et ainsi de suite.

Étape 1:

1. Appuyez sur  pour accéder à la page du menu. Vérifiez  et appuyez .

2. Choisissez le temps.

Sélectionnez **OFF** pour désactiver la fonctionnalité de rappel d'alimentation.





Remarque: sélectionnez  pour régler l'alarme à l'heure spécifiée.

DATE/UHEURES

Explication:

Cette fonction permet de définir la date / heure, d'activer / désactiver l' .

Étape 1:

1. Appuyez sur  pour accéder à la page du menu. Vérifiez  et appuyez .

2. Appuyez sur **OK** pour démarrer / terminer la configuration. Le représentant de  commence le réglage,

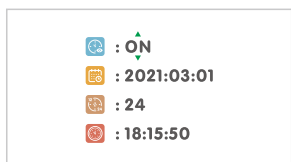
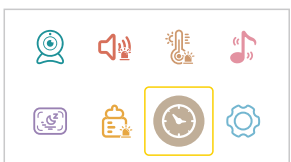

3.  est synonyme de réglage final.

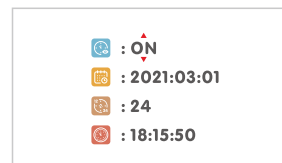

Note:

* Appuyez sur les boutons **Haut / Bas / Gauche / Droite** pour sélectionner, puis appuyez sur le bouton  pour confirmer.



* Si l'  est activé, la date et l'heure seront affichées sur la barre d'état du moniteur. Sinon, il ne sera pas affiché.

RÉGLAGES

Explication:

De restaurer les paramètres d'usine et de fournir des informations de support technique.

Étape 1:

1. Appuyez sur  pour accéder à la page du menu. Vérifiez  et appuyez .

1. Sélectionnez et appuyez  Appuyez sur  pour entrer dans l'interface.

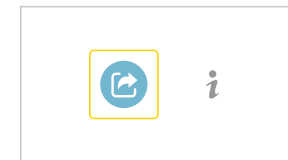
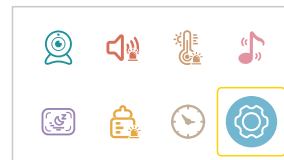

2. Confirmez l'option YES, restaurez les paramètres d'usine. Appuyez sur  ou confirmez NO pour quitter.

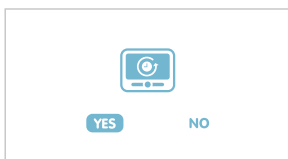

1. Choisissez .
Appuyez sur  pour entrer dans l'interface.

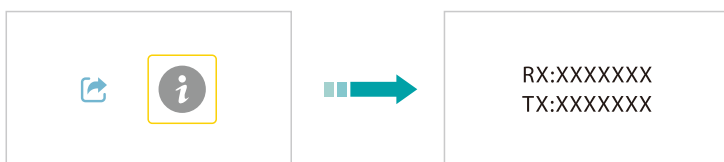





EXPLICATION DES ICÔNES



1. Icônes de la barre d'état

-  : Aucune connexion de signal
-  : Force du signal
-  : Boucle vidéo en direct
-  : Berceuses activées
-  : Mode veille activé
-  27°C : Température ambiante actuelle
-  : Niveau de batterie
-  : Détection sonore activée
-  : Alarme de température activée
-  : Rappel d'alimentation activé
-  x2 : Grossissement 2 fois
-  x4 : Grossissement 4 fois
-  : Mode nuit
- VOX** : Le mode VOX est activé

2. Icônes de notifications

-  : Aucune caméra connectée
-  : Alarme sonore
-  : Alarme de température
-  : Notification d'alimentation

Note:

Vous pouvez activer la fonction boucle de vidéo en direct en cliquant sur le bouton  jusqu'à quand tu vois  dans la barre d'état. Lorsque la fonction boucle de vidéo en direct est démarrée, la caméra connectée est automatiquement commutée toutes les 10 secondes. En cas de la détection sonore / de température, la fonction de commutation de caméra est temporairement suspendue.

FAQ

Q1. Pourquoi n'ai-je pas réussi à connecter la caméra au moniteur?

- * Assurez-vous de brancher fermement l'adaptateur d'alimentation sur la caméra et sur la prise.
- * Assurez-vous que la caméra et le moniteur se trouvent dans la distance effective.

Q2. Pourquoi la vidéo en direct est-elle si floue?

- * Assurez-vous qu'il n'y a pas d'obstacle sur la lentille ou devant la caméra.

Q3. Pourquoi le moniteur a-t-il fait du bruit?

- * La caméra et le moniteur sont peut-être trop proches. Mettez-les plus éloignés.

Q4. Puis-je entendre mon bébé lorsque j'éteins l'écran?

- * Oui. Vous devez activer la détection du son pour que l'écran se réactive et déclenche une alarme sonore si un son fort est détecté.

Q5. Pourquoi la photo est-elle en noir et blanc?

- * Le mode de vision nocturne est activé si la caméra fonctionne dans un environnement sombre (luminosité ≤ 5 lux).

FCC WARNING

This device complies with part 15 of the FCC Rules. Operation is subject to the following two conditions: (1) this device may not cause harmful interference, and (2) this device must accept any interference received, including interference that may cause undesired operation.

Any changes or modifications not expressly approved by the party responsible for compliance could void the user's authority to operate the equipment.

NOTE: This equipment has been tested and found to comply with the limits for a Class B digital device, pursuant to Part 15 of the FCC Rules. These limits are designed to provide reasonable protection against harmful interference in a residential installation. This equipment generates, uses and can radiate radio frequency energy and, if not installed and used in accordance with the instructions, may cause harmful interference to radio communications.

However, there is no guarantee that interference will not occur in a particular installation.

If this equipment does cause harmful interference to radio or television reception, which can be determined by turning the equipment off and on, the user is encouraged to try to correct the interference by one or more of the following measures:

- Reorient or relocate the receiving antenna.
- Increase the separation between the equipment and receiver.
- Connect the equipment into an outlet on a circuit different from that to which the receiver is connected.
- Consult the dealer or an experienced radio/TV technician for help.

To maintain compliance with FCC's RF Exposure guidelines, This equipment should be installed and operated with minimum distance between 20cm the radiator your body: Use only the supplied antenna.