

TEST REPORT

Product Name : Pro Air Purifier
Model Number : Miya, Miya 2.0, Max, Max2.0, Mage, Mage2.0
FCC ID : 2ATIZ-MIYA20

Prepared for : Guangdong Invitop Technology Co., Ltd
Address : Minsen Information Technology Industrial Park, East of Jinsan Avenue, Sanjiao, Zhongshan, Guangdong, China

Prepared by : EMTEK (SHENZHEN) CO., LTD.
Address : Bldg 69, Majialong Industry Zone, Nanshan District, Shenzhen, Guangdong, China

Tel: (0755) 26954280

Fax: (0755) 26954282

Report Number : ENS2205300272W00101R
Date(s) of Tests : June 10, 2022 to June 30, 2022
Date of issue : July 1, 2022

TABLE OF CONTENTS

1 TEST RESULT CERTIFICATION.....	3
2 EUT TECHNICAL DESCRIPTION.....	5
3 SUMMARY OF TEST RESULT.....	6
4 TEST METHODOLOGY.....	7
4.1 GENERAL DESCRIPTION OF APPLIED STANDARDS.....	7
4.2 MEASUREMENT EQUIPMENT USED.....	7
4.3 DESCRIPTION OF TEST MODES.....	8
5 FACILITIES AND ACCREDITATIONS.....	9
5.1 FACILITIES.....	9
5.2 LABORATORY ACCREDITATIONS AND LISTINGS.....	9
6 TEST SYSTEM UNCERTAINTY.....	10
7 SETUP OF EQUIPMENT UNDER TEST.....	11
7.1 RADIO FREQUENCY TEST SETUP 1.....	11
7.2 RADIO FREQUENCY TEST SETUP 2.....	11
7.3 CONDUCTED EMISSION TEST SETUP.....	13
7.4 BLOCK DIAGRAM CONFIGURATION OF TEST SYSTEM.....	14
7.5 SUPPORT EQUIPMENT.....	14
8 TEST REQUIREMENTS.....	15
8.1 DTS 6DB BANDWIDTH.....	15
8.2 MAXIMUM PEAK CONDUCTED OUTPUT POWER.....	17
8.3 MAXIMUM POWER SPECTRAL DENSITY.....	19
8.4 UNWANTED EMISSIONS IN NON-RESTRICTED FREQUENCY BANDS.....	21
8.5 RADIATED SPURIOUS EMISSION.....	27
8.6 CONDUCTED EMISSIONS TEST.....	40
8.7 ANTENNA APPLICATION.....	43

1 TEST RESULT CERTIFICATION

Applicant : Guangdong Invitop Technology Co., Ltd
 Address : Minsen Information Technology Industrial Park, East of Jinsan Avenue, Sanjiao, Zhongshan, Guangdong, China
 Manufacturer : Guangdong Invitop Technology Co., Ltd
 Address : Minsen Information Technology Industrial Park, East of Jinsan Avenue, Sanjiao, Zhongshan, Guangdong, China
 EUT : Pro Air Purifier
 Model Name : Miya, Miya 2.0, Max, Max2.0, Mage, Mage2.0
 (Note: The only difference in models is the appearance and control plate location, all other information is the same.)
 Trademark : N/A

Measurement Procedure Used:

APPLICABLE STANDARDS	
STANDARD	TEST RESULT
FCC 47 CFR Part 2 , Subpart J FCC 47 CFR Part 15, Subpart C	PASS

The above equipment was tested by EMTEK(SHENZHEN) CO., LTD. The test data, data evaluation, test procedures, and equipment configurations shown in this report were made in accordance with the procedures given in ANSI C63.10 (2013) and the energy emitted by the sample EUT tested as described in this report is in compliance with the requirements of FCC Rules Part 2 and Part 15.247

The test results of this report relate only to the tested sample identified in this report

Date of Test : June 10, 2022 to June 30, 2022

Prepared by : Una Yu
Una Yu/Editor

Reviewer : Joe Xia
Joe Xia/Supervisor

Approved & Authorized Signer : Lisa Wang
Lisa Wang/Manager

Modified Information

Version	Report No.	Revision Date	Summary
Ver.1.0	ENS2205300272W00101R	/	Original Report

2 EUT TECHNICAL DESCRIPTION

Product	Pro Air Purifier
Model Number	Miya, Miya 2.0, Max, Max2.0, Mage, Mage2.0 (Note: The only difference in models is the appearance and control plate location, all other information is the same.)
Device Type	BLE V4.2
Data Rate	1Mbps
Modulation	GFSK
Operating Frequency Range	2402-2480MHz
Number of Channels	40 Channels
Antenna Type	PCB Antenna
Antenna Gain	2.5 dBi
Power Supply	AC 120V/60Hz
Temperature Range	-10°C ~ 50°C

Note: for more details, please refer to the user's manual of the EUT.

3 SUMMARY OF TEST RESULT

FCC Part Clause	Test Parameter	Verdict	Remark
15.247(a)(2)	DTS (6dB) Bandwidth	PASS	
15.247(b)(3)	Maximum Peak Conducted Output Power	PASS	
15.247(e)	Maximum Power Spectral Density Level	PASS	
15.247(d)	Unwanted Emission Into Non-Restricted Frequency Bands	PASS	
15.247(d) 15.209	Unwanted Emission Into Restricted Frequency Bands (conducted)	PASS	
15.247(d) 15.209	Radiated Spurious Emission	PASS	
15.207	Conducted Emission Test	PASS	
15.247(b)	Antenna Application	PASS	
	NOTE1: N/A (Not Applicable) NOTE2: According to FCC OET KDB 558074, the report use radiated measurements in the restricted frequency bands. In addition, the radiated test is also performed to ensure the emissions emanating from the device cabinet also comply with the applicable limits.		

RELATED SUBMITTAL(S) / GRANT(S):

This submittal(s) (test report) is intended for FCC ID: 2ATIZ-MIYA20 filing to comply with Section 15.247 of the FCC Part 15, Subpart C Rules.

4 TEST METHODOLOGY

4.1 GENERAL DESCRIPTION OF APPLIED STANDARDS

According to its specifications, the EUT must comply with the requirements of the following standards:
 FCC 47 CFR Part 2, Subpart J
 FCC 47 CFR Part 15, Subpart C
 FCC KDB 558074 D01 15.247 Meas Guidance v05r02

4.2 MEASUREMENT EQUIPMENT USED

For Conducted Emission Test Equipment

Equipment	Manufacturer	Model No.	Serial No.	Last Cal.	Cal. Interval
EMI Test Receiver	Rohde & Schwarz	ESCI	101045	2022/5/14	1Year
PULSE LIMTER	Rohde & Schwarz	ESH3-Z2	100107	2022/5/14	1Year
AMN	Rohde & Schwarz	ESH3-Z5	100191	2022/5/15	1Year
AMN	Schwarzbeck	NNLK 8129	8129203	2022/5/15	1Year
V-Network	Rohde & Schwarz	ESH3-Z6	100011	2022/5/15	1Year
V-Network	Rohde & Schwarz	ESH3-Z6	100253	2022/5/15	1Year

For Spurious Emissions Test

Equipment	Manufacturer	Model No.	Serial No.	Last Cal.	Cal. Interval
Pre-Amplifier	HP	8447F	2944A07999	2022/5/14	1Year
EMI Test Receiver	Rohde & Schwarz	ESCI	101414	2022/5/14	1Year
Bilog Antenna	Schwarzbeck	VULB9163	712	2021/7/5	2 Year
Horn antenna	Schwarzbeck	BBHA9120D	9120D-1178	2020/7/4	2 Year
Pre-Amplifie	Lunar EM	LNA1G18-48	J1011131010 001	2021/5/15	1Year
Spectrum Analyzer	Rohde & Schwarz	FSV40	100967	2022/5/14	1Year
Horn antenna	Schwarzbeck	BBHA9170	9170-399	2021/6/12	2 Year
Loop Antenna	Schwarzbeck	FMZB1519	1519-012	2021/6/12	2 Year

For other test items:

Equipment	Manufacturer	Model No.	Serial No.	Last Cal.	Cal. Interval
Signal Analyzer	Agilent	N9010A	MY53470879	2022/5/14	1Year
Spectrum Analyzer	Rohde & Schwarz	FSV40	100967	2022/5/14	1Year
Power Meter	\	PS-X10-100	\	2022/5/15	1Year
Temp/ Humidity Chamber	ESPEC	EL-02KA	12107166	2021/7/3	1Year

4.3 DESCRIPTION OF TEST MODES

The EUT has been tested under its typical operating condition.

The EUT configuration for testing is installed on RF field strength measurement to meet the Commissions requirement and operating in a manner which intends to maximize its emission characteristics in a continuous normal application.

The Transmitter was operated in the normal operating mode. The TX frequency was fixed which was for the purpose of the measurements.

Test of channel included the lowest and middle and highest frequency to perform the test, then record on this report.

Those data rates were used for all test.

Pre-defined engineering program for regulatory testing used to control the EUT for staying in continuous transmitting and receiving mode is programmed.

Frequency and Channel list:

Channel	Frequency (MHz)	Channel	Frequency (MHz)	Channel	Frequency (MHz)
0	2402	19	2440
1	2404	20	2442	37	2476
2	2406	21	2444	38	2478
...	39	2480

Note: $f_c=2402\text{MHz}+k \times 1\text{MHz}$ $k=1$ to 39

Test Frequency and channel:

Lowest Frequency		Middle Frequency		Highest Frequency	
Channel	Frequency (MHz)	Channel	Frequency (MHz)	Channel	Frequency (MHz)
0	2402	19	2440	39	2480

5 FACILITIES AND ACCREDITATIONS

5.1 FACILITIES

All measurement facilities used to collect the measurement data are located at

Bldg 69, Majialong Industry Zone District, Nanshan District, Shenzhen, China

The sites are constructed in conformance with the requirements of ANSI C63.7, ANSI C63.10 and CISPR Publication 22.

5.2 LABORATORY ACCREDITATIONS AND LISTINGS

Site Description

EMC Lab.

: **Accredited by CNAS**

The Certificate Registration Number is L2291

The Laboratory has been assessed and proved to be in compliance with CNAS-CL01 (identical to ISO/IEC 17025:2017)

Accredited by FCC

Designation Number: CN1204

Test Firm Registration Number: 882943

Accredited by A2LA

The Certificate Number is 4321.01

Accredited by Industry Canada

The Conformity Assessment Body Identifier is CN0008

Name of Firm

: EMTEK (SHENZHEN) CO., LTD.

Site Location

: Building 69, Majialong Industry Zone, Nanshan District, Shenzhen, Guangdong, China

6 TEST SYSTEM UNCERTAINTY

The following measurement uncertainty levels have been estimated for tests performed on the apparatus:

Test Parameter	Measurement Uncertainty
RF Output Power	±1.0%
Power Spectral Density	±0.9%
Duty Cycle and Tx-Sequence and Tx-Gap	±1.3%
Medium Utilisation Factor	±1.5%
Occupied Channel Bandwidth	±2.3%
Transmitter Unwanted Emission in the Out-of Band	±1.2%
Transmitter Unwanted Emissions in the Spurious Domain	±2.7%
Receiver Spurious Emissions	±2.7%
Temperature	±3.2%
Humidity	±2.5%

Measurement Uncertainty for a level of Confidence of 95%

7 SETUP OF EQUIPMENT UNDER TEST

7.1 RADIO FREQUENCY TEST SETUP 1

The BLE component's antenna ports(s) of the EUT are connected to the measurement instrument per an appropriate attenuator. The EUT is controlled by PC/software to emit the specified signals for the purpose of measurements.

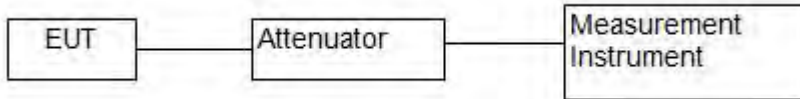

7.2 RADIO FREQUENCY TEST SETUP 2

The test site semi-anechoic chamber has met the requirement of NSA tolerance 4 dB according to the standards: ANSI C63.10. The test distance is 3m. The setup is according to the requirements in Section 13.1.4.1 of ANSI C63.10-2013 and CAN/CSA-CEI/IEC CISPR 22.

Below 30MHz:

The EUT is placed on a turntable 0.8 meters above the ground in the chamber, 3 meter away from the antenna (loop antenna). The Antenna should be positioned with its plane vertical at the specified distance from the EUT and rotated about its vertical axis for maximum response at each azimuth about the EUT. The center of the loop shall be 1 m above the ground. For certain applications, the loop antenna plane may also need to be positioned horizontally at the specified distance from the EUT.

30MHz-1GHz:

The EUT is placed on a turntable 0.8 meters above the ground in the chamber, 3 meter away from the antenna. The maximal emission value is acquired by adjusting the antenna height, polarisation and turntable azimuth. Normally, the height range of antenna is 1 m to 4 m, the azimuth range of turntable is 0° to 360°, and the receive antenna has two polarizations Vertical (V) and Horizontal (H).

Above 1GHz:

The EUT is placed on a turntable 1.5 meters above the ground in the chamber, 3 meter away from the antenna. The maximal emission value is acquired by adjusting the antenna height, polarisation and turntable azimuth. Normally, the height range of antenna is 1 m to 4 m, the azimuth range of turntable is 0° to 360°, and the receive antenna has two polarizations Vertical (V) and Horizontal (H).

(a) Radiated Emission Test Set-Up, Frequency Below 30MHz

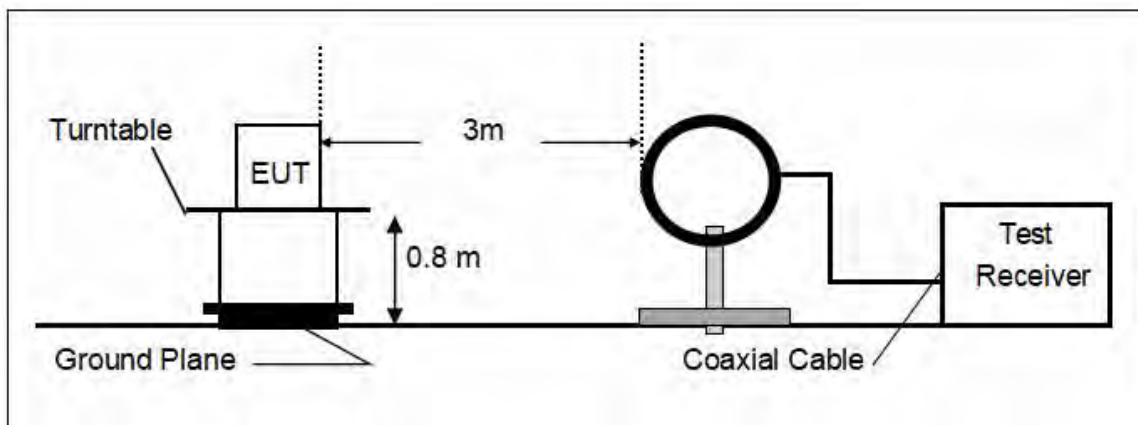

(b) Radiated Emission Test Set-Up, Frequency Below 1000MHz

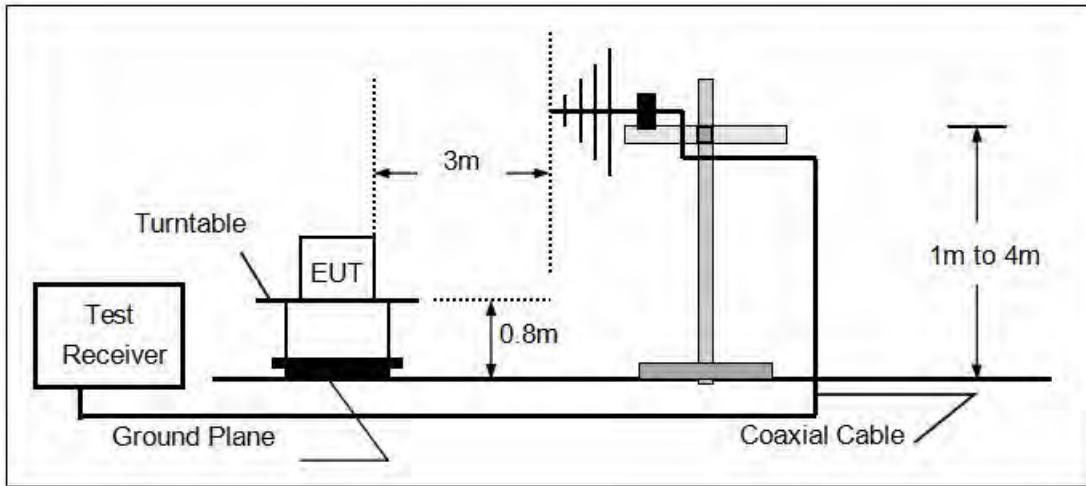

(c) Radiated Emission Test Set-Up, Frequency above 1000MHz

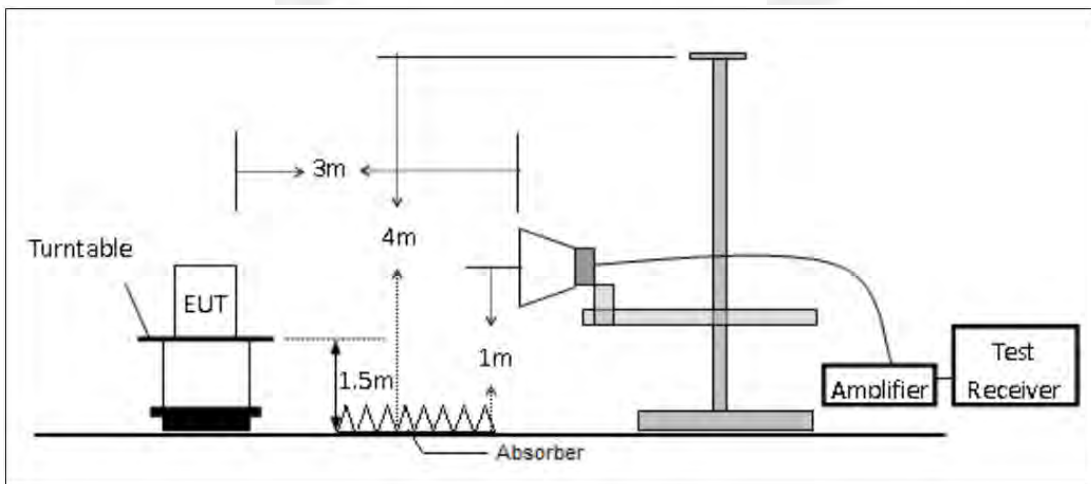

7.3 CONDUCTED EMISSION TEST SETUP

The mains cable of the EUT (maybe per AC/DC Adapter) must be connected to LISN. The LISN shall be placed 0.8 m from the boundary of EUT and bonded to a ground reference plane for LISN mounted on top of the ground reference plane. This distance is between the closest points of the LISN and the EUT. All other units of the EUT and associated equipment shall be at least 0.8m from the LISN.

Ground connections, where required for safety purposes, shall be connected to the reference ground point of the LISN and, where not otherwise provided or specified by the manufacturer, shall be of same length as the mains cable and run parallel to the mains connection at a separation distance of not more than 0.1 m.

According to the requirements in Section 13.1.4.1 of ANSI C63.10-2013 Conducted emissions from the EUT measured in the frequency range between 0.15 MHz and 30 MHz using CISPR Quasi-Peak and average detector mode.

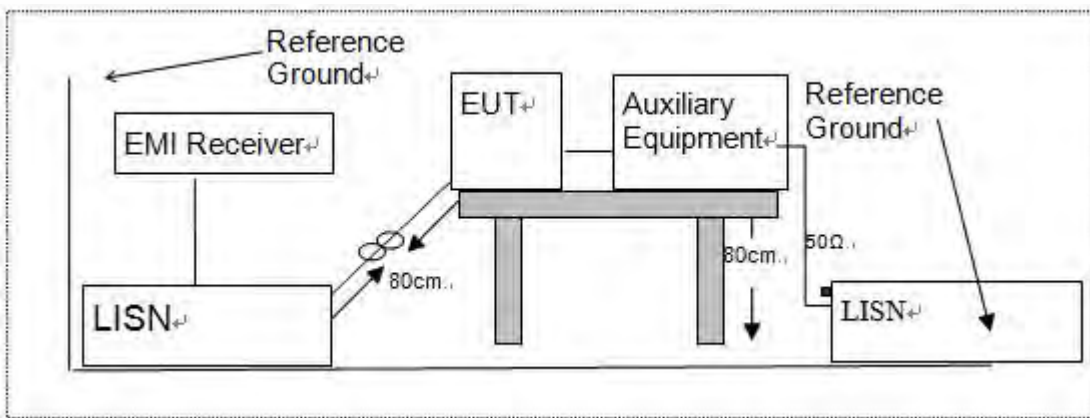

7.4 BLOCK DIAGRAM CONFIGURATION OF TEST SYSTEM

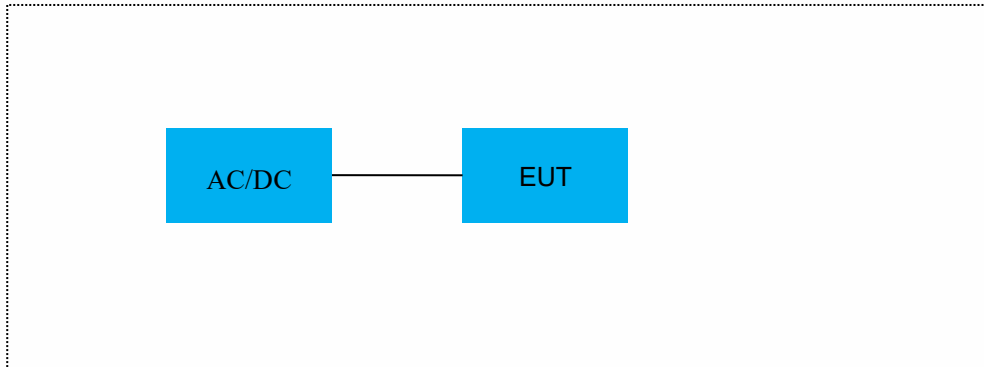

7.5 SUPPORT EQUIPMENT

EUT Cable List and Details			
Cable Description	Length (m)	Shielded/Unshielded	With / Without Ferrite

Auxiliary Cable List and Details			
Cable Description	Length (m)	Shielded/Unshielded	With / Without Ferrite

Auxiliary Equipment List and Details			
Description	Manufacturer	Model	Serial Number
AAA Battery	Panasonic	R03PNU	/

Notes:

1. All the equipment/cables were placed in the worst-case configuration to maximize the emission during the test.
2. Grounding was established in accordance with the manufacturer's requirements and conditions for the intended use.

8 TEST REQUIREMENTS

8.1 DTS 6DB BANDWIDTH

8.1.1 Applicable Standard

According to FCC Part 15.247(a)(2) and KDB 558074 D01 15.247 Meas Guidance v05r02

8.1.2 Conformance Limit

The minimum -6 dB bandwidth shall be at least 500 kHz.

8.1.3 Test Configuration

Test according to clause 7.1 radio frequency test setup 1

8.1.4 Test Procedure

The EUT was operating in BLE mode and controlled its channel. Printed out the test result from the spectrum by hard copy function.

The RF output of EUT was connected to the spectrum analyzer by RF cable and attenuator. The path loss was compensated to the results for each measurement.

Set to the maximum power setting and enable the EUT transmit continuously

Set RBW = 100 kHz.

Set the video bandwidth (VBW) =300 kHz.

Set Span=2 times OBW

Set Detector = Peak.

Set Trace mode = max hold.

Set Sweep = auto couple.

Allow the trace to stabilize.

Measure the maximum width of the emission that is constrained by the frequencies associated with the two outermost amplitude points (upper and lower frequencies) that are attenuated by 6 dB relative to the maximum level measured in the fundamental emission.

Measure and record the results in the test report.

Test Results

Temperature:	25° C
Relative Humidity:	45%
ATM Pressure:	1011 mbar

TestMode	Antenna	Frequency[MHz]	DTS BW [MHz]	FL[MHz]	FH[MHz]	Limit[MHz]	Verdict
BLE_1M	Ant1	2402	0.664	2401.660	2402.324	0.5	PASS
		2440	0.656	2439.664	2440.320	0.5	PASS
		2480	0.672	2479.652	2480.324	0.5	PASS



BLE 1M Ant1_2402

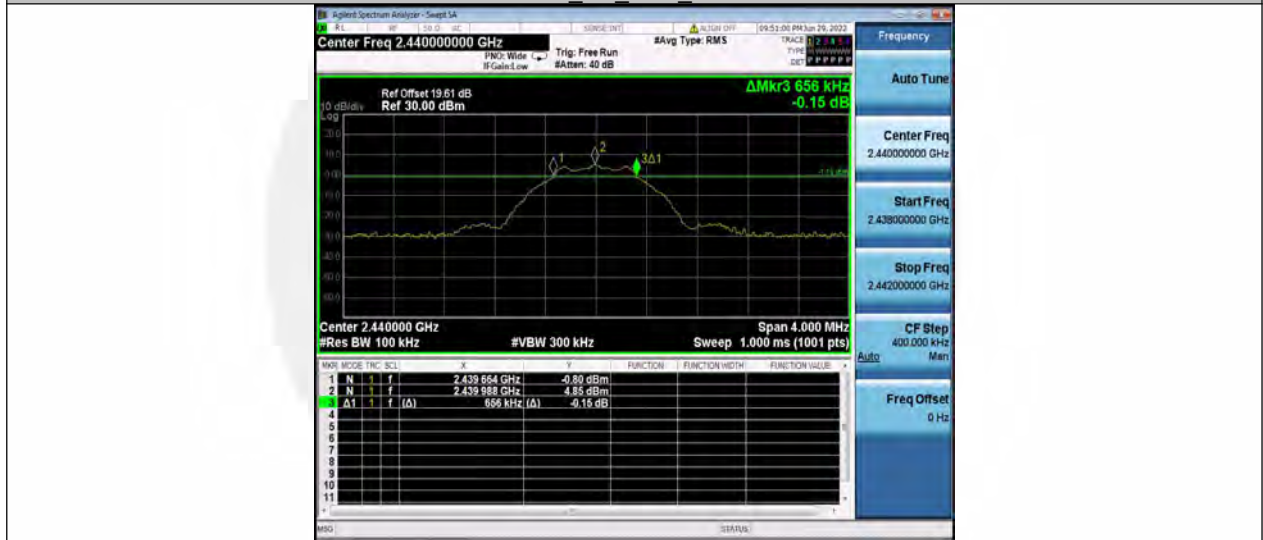

BLE 1M Ant1_2440



BLE 1M Ant1_2480

8.2 MAXIMUM PEAK CONDUCTED OUTPUT POWER

8.2.1 Applicable Standard

According to FCC Part 15.247(b)(3) and KDB 558074 D01 15.247 Meas Guidance v05r02

8.2.2 Conformance Limit

The maximum peak conducted output power of the intentional radiator for systems using digital modulation in the 2400 - 2483.5 MHz bands shall not exceed: 1 Watt (30dBm).

8.2.3 Test Configuration

Test according to clause 7.1 radio frequency test setup 1

8.2.4 Test Procedure

■ According to FCC Part15.247(b)(3)

As an alternative to a peak power measurement, compliance with the one Watt limit can be based on a measurement of the maximum conducted output power. For smart system, Maximum Conducted Output Power is defined as the total transmit power delivered to all antennas and antenna elements averaged across all symbols in the signaling alphabet when the transmitter is operating at its maximum power control level. Power must be summed across all antennas and antenna elements. If multiple modes of operation are possible (e.g., alternative modulation methods), the maximum conducted output power is the highest total transmit power occurring in any mode.

Set the RBW \cong DTS bandwidth(about 1MHz).

Set VBW =3*RBW(about 3MHz)

Set the span \cong 3*RBW

Set Sweep time = auto couple.

Set Detector = peak.

Set Trace mode = max hold.

Allow trace to fully stabilize. Use peak marker function to determine the peak amplitude level.

■ According to FCC Part 15.247(b)(4):

Conducted output power limit specified in paragraph (b) of this section is based on the use of antennas with directional gains that do not exceed 6 dBi. If transmitting antennas of directional gain greater than 6 dBi are used, the conducted output power from the intentional radiator shall be reduced below the stated values in paragraphs (b)(3) of this section, as appropriate, by the amount in dB that the directional gain of the antenna exceeds 6 dBi.

Test Results

Temperature:	25° C
Relative Humidity:	45%
ATM Pressure:	1011 mbar

TestMode	Antenna	Frequency[MHz]	Conducted Peak Power[dBm]	Conducted Limit[dBm]	EIRP[dBm]	EIRP Limit[dBm]	Verdict
BLE_1M	Ant1	2402	5.23	≤ 30	7.73	≤ 36	PASS
		2440	5.57	≤ 30	8.07	≤ 36	PASS
		2480	6.19	≤ 30	8.69	≤ 36	PASS



BLE 1M Ant1_2402

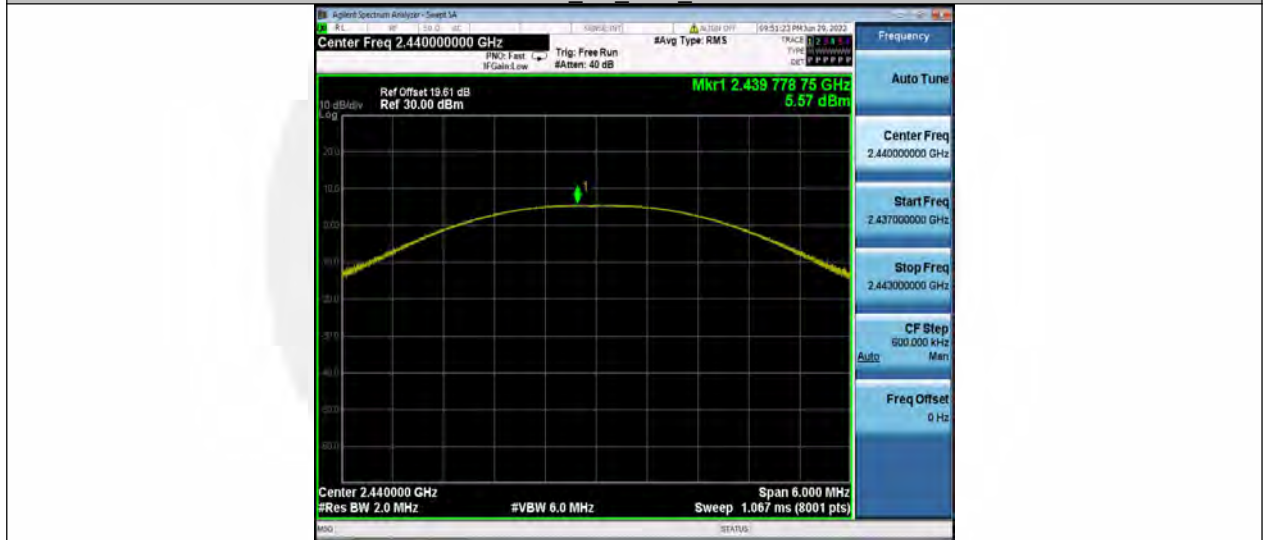

BLE 1M Ant1_2440



BLE 1M Ant1_2480

8.3 MAXIMUM POWER SPECTRAL DENSITY

8.3.1 Applicable Standard

According to FCC Part 15.247(e) and KDB 558074 D01 15.247 Meas Guidance v05r02

8.3.2 Conformance Limit

The transmitter power spectral density conducted from the transmitter to the antenna shall not be greater than 8 dBm in any 3 kHz band during any time interval of continuous transmission.

8.3.3 Test Configuration

Test according to clause 7.1 radio frequency test setup 1

8.3.4 Test Procedure

This procedure shall be used if maximum peak conducted output power was used to demonstrate compliance

The transmitter output (antenna port) was connected to the spectrum analyzer

Set analyzer center frequency to DTS channel center frequency.

Set the span to 1.5 times the DTS bandwidth.

Set the RBW to: 3 kHz

Set the VBW to: 10 kHz.

Set Detector = peak.

Set Sweep time = auto couple.

Set Trace mode = max hold.

Allow trace to fully stabilize.

Use the peak marker function to determine the maximum amplitude level within the RBW.

8.3.5 Test Results

Temperature:	25° C
Relative Humidity:	45%
ATM Pressure:	1011 mbar

TestMode	Antenna	Frequency[MHz]	Result[dBm/3kHz]	Limit[dBm/3kHz]	Verdict
BLE_1M	Ant1	2402	-10.63	≤8.00	PASS
		2440	-11.26	≤8.00	PASS
		2480	-9.05	≤8.00	PASS

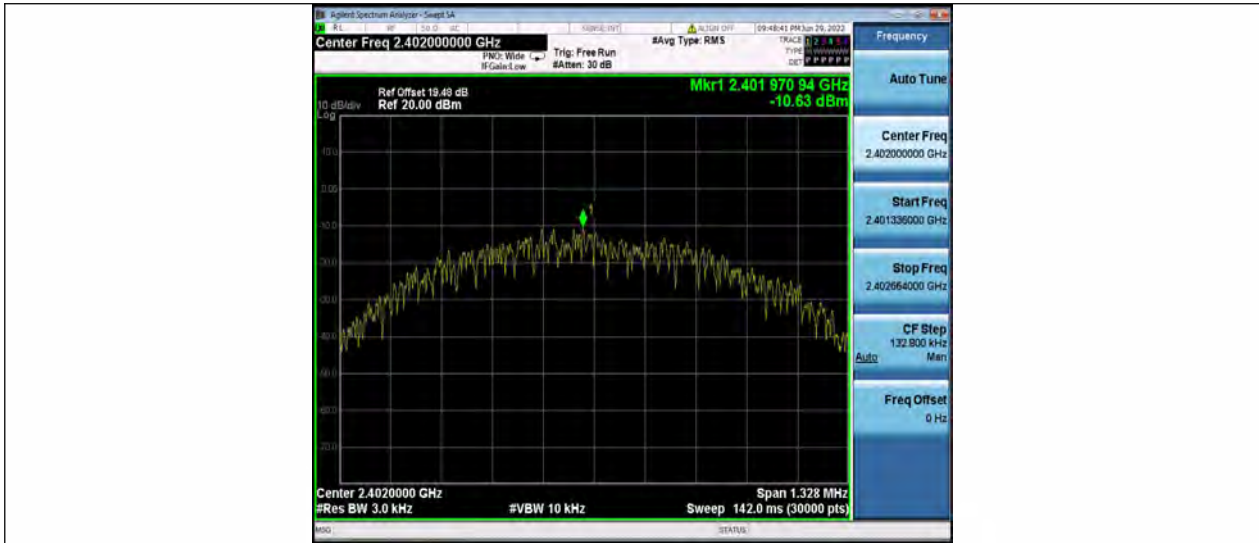

BLE 1M Ant1_2402

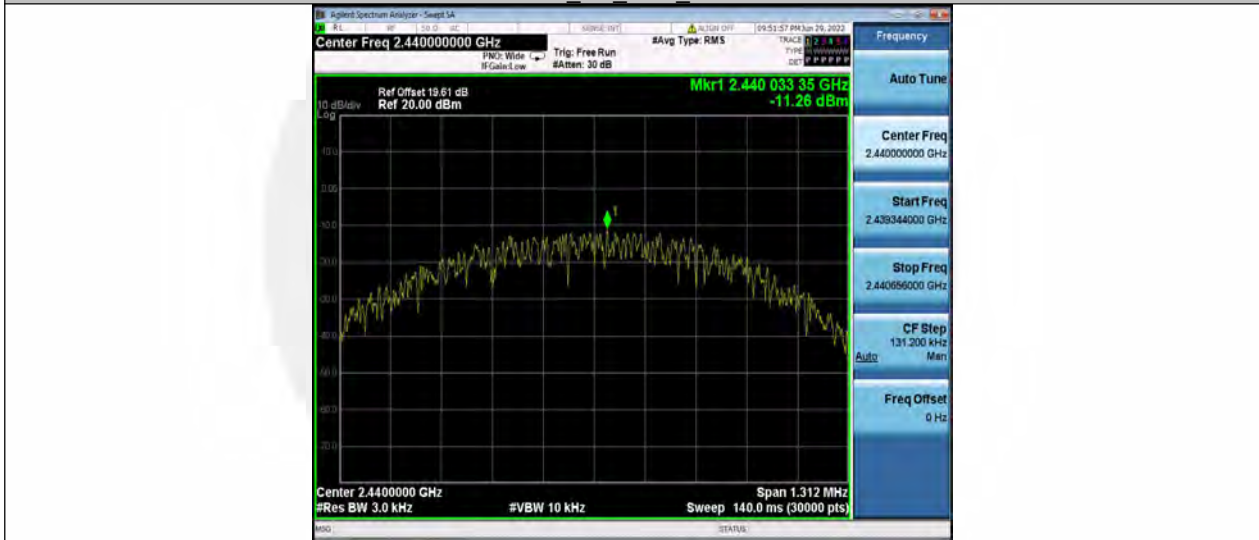

BLE 1M Ant1_2440

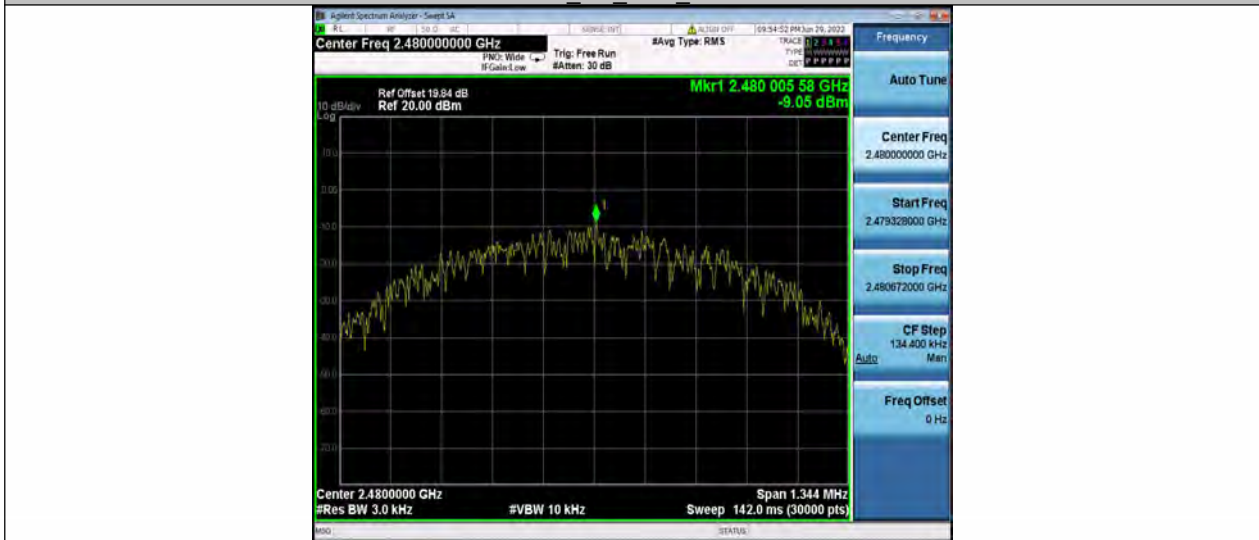

BLE 1M Ant1_2480

8.4 UNWANTED EMISSIONS IN NON-RESTRICTED FREQUENCY BANDS

8.4.1 Applicable Standard

According to FCC Part 15.247(d) and KDB 558074 D01 15.247 Meas Guidance v05r02

8.4.2 Conformance Limit

According to FCC Part 15.247(d):

In any 100 kHz bandwidth outside the frequency band in which the spread spectrum or digitally modulated intentional radiator is operating, the radio frequency power that is produced by the intentional radiator shall be at least 20 dB below that in the 100 kHz bandwidth within the band that contains the highest level of the desired power, based on either an RF conducted or a radiated measurement, provided the transmitter demonstrates compliance with the peak conducted power limits. If the transmitter complies with the conducted power limits based on the use of RMS averaging over a time interval, as permitted under paragraph (b)(3) of this section, the attenuation required under this paragraph shall be 30 dB instead of 20 dB.

8.4.3 Test Configuration

Test according to clause 7.1 radio frequency test setup 1

8.4.4 Test Procedure

The transmitter output (antenna port) was connected to the spectrum analyzer

■ Reference level measurement

Establish a reference level by using the following procedure:

Set instrument center frequency to DTS channel center frequency.

Set the span to = 1.5 times the DTS bandwidth.

Set the RBW = 100 kHz.

Set the VBW $\geq 3 \times$ RBW.

Set Detector = peak.

Set Sweep time = auto couple.

Set Trace mode = max hold.

Allow trace to fully stabilize.

Use the peak marker function to determine the maximum PSD level.

Note that the channel found to contain the maximum PSD level can be used to establish the reference level.

■ Emission level measurement

Set the center frequency and span to encompass frequency range to be measured.

Set the RBW = 100 kHz.

Set the VBW = 300 kHz.

Set Detector = peak

Sweep time = auto couple.

Trace mode = max hold.

Allow trace to fully stabilize.

Use the peak marker function to determine the maximum amplitude level.

Ensure that the amplitude of all unwanted emissions outside of the authorized frequency band (excluding restricted frequency bands) are attenuated by at least the minimum requirements. Report the three highest emissions relative to the limit.

8.4.5 Test Results

Temperature:	25° C
Relative Humidity:	45%
ATM Pressure:	1011 mbar

Emission level measurement

TestMode	Antenna	Frequency[MHz]	FreqRange [MHz]	RefLevel [dBm]	Result[dBm]	Limit[dBm]	Verdict
BLE_1M	Ant1	2402	Reference	4.88	4.88	---	PASS
			30~1000	4.88	-45.12	≤-15.12	PASS
			1000~26500	4.88	-29.99	≤-15.12	PASS
		2440	Reference	4.71	4.71	---	PASS
			30~1000	4.71	-45.14	≤-15.29	PASS
			1000~26500	4.71	-29.42	≤-15.29	PASS
		2480	Reference	5.33	5.33	---	PASS
			30~1000	5.33	-45.17	≤-14.67	PASS
			1000~26500	5.33	-29.46	≤-14.67	PASS



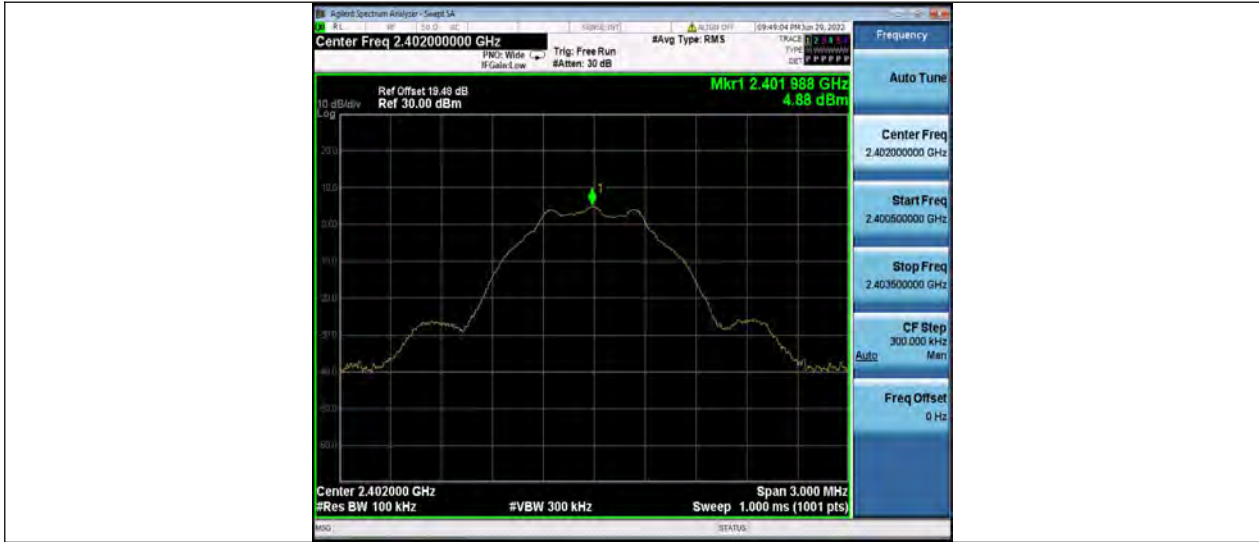

BLE 1M Ant1 2402 0~Reference



BLE 1M Ant1 2402 30~1000



BLE 1M Ant1 2402 1000~26500

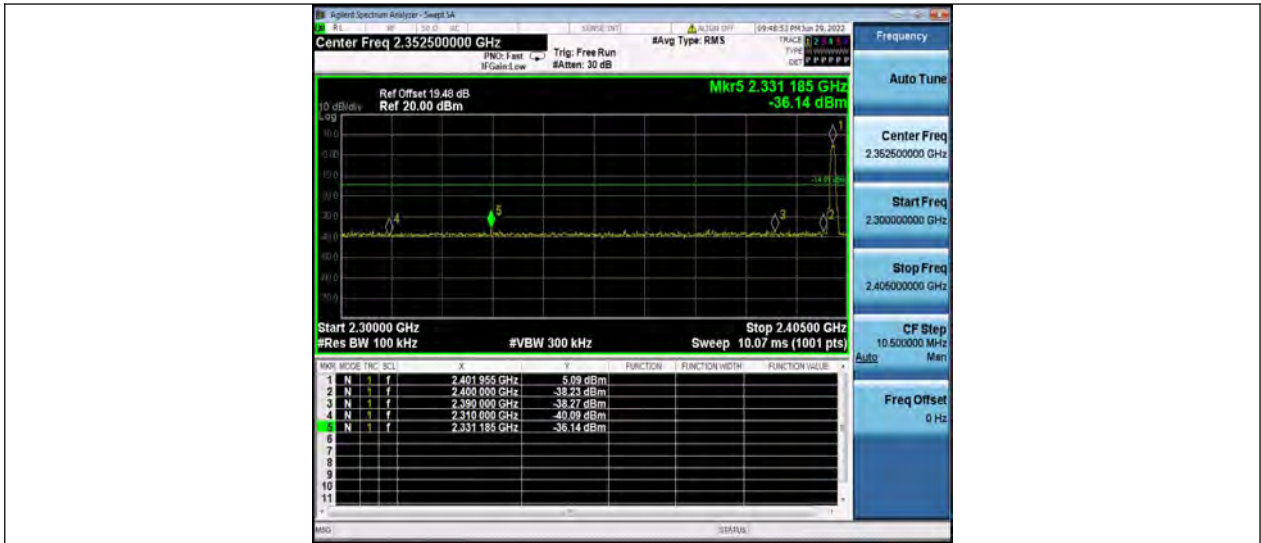

BLE 1M Ant1 Low 2402



BLE 1M Ant1 2440 0~Reference

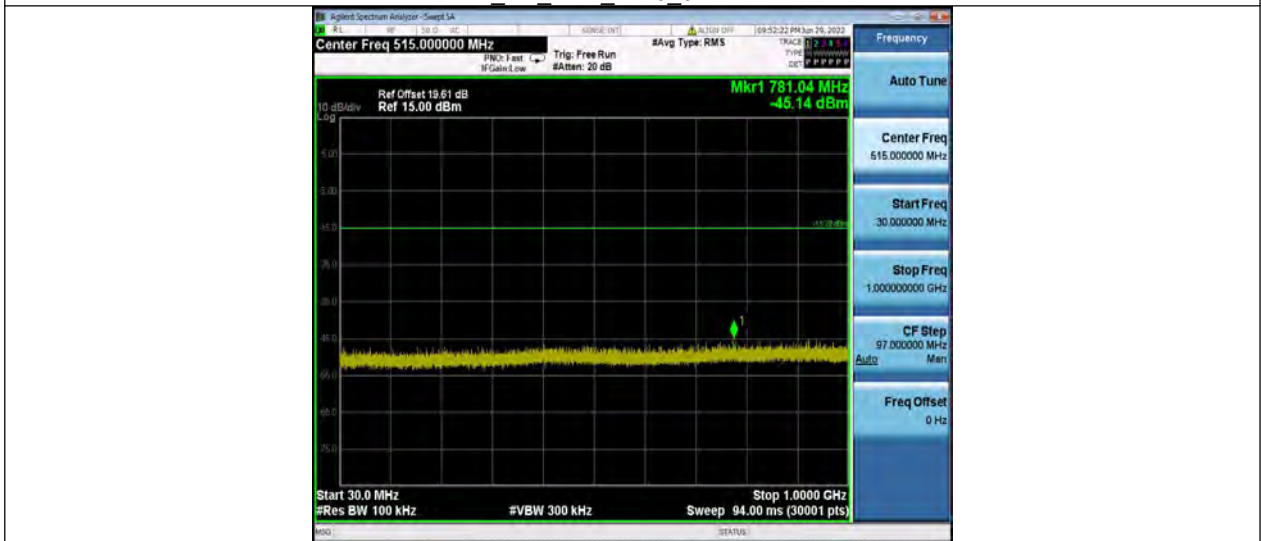

BLE 1M Ant1 2440 30~1000



BLE 1M Ant1 2440 1000~26500



BLE_1M_Ant1_2480_0~Reference

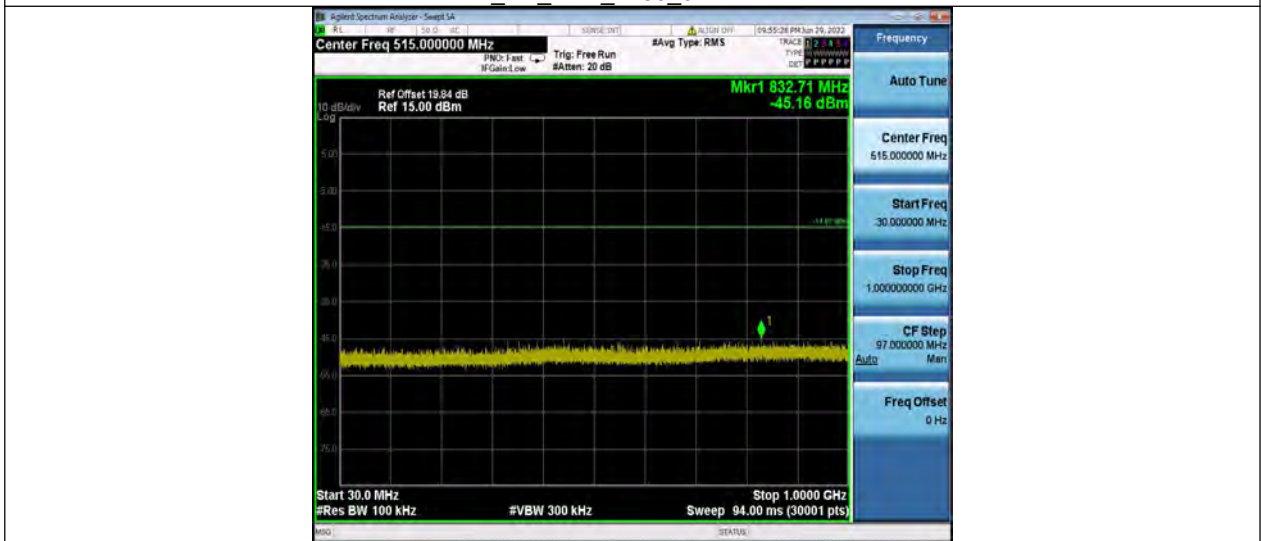

BLE_1M_Ant1_2480_30~1000



BLE 1M Ant1 2480 1000~26500



BLE 1M Ant1_High 2480

8.5 RADIATED SPURIOUS EMISSION

8.5.1 Applicable Standard

According to FCC Part 15.247(d) and 15.209 and KDB 558074 D01 15.247 Meas Guidance v05r02

8.5.2 Conformance Limit

According to FCC Part 15.247(d): radiated emissions which fall in the restricted bands, as defined in §15.205(a), must also comply with the radiated emission limits specified in §15.209(a) (see §15.205(c)).

According to FCC Part 15.205, Restricted bands

MHz	MHz	MHz	GHz
0.090-0.110	16.42-16.423	399.9-410	4.5-5.15
10.495-0.505	16.69475-16.69525	608-614	5.35-5.46
2.1735-2.1905	16.80425-16.80475	960-1240	7.25-7.75
4.125-4.128	25.5-25.67	1300-1427	8.025-8.5
4.17725-4.17775	37.5-38.25	1435-1626.5	9.0-9.2
4.20725-4.20775	73-74.6	1645.5-1646.5	9.3-9.5
6.215-6.218	74.8-75.2	1660-1710	10.6-12.7
6.26775-6.26825	123-138	2200-2300	14.47-14.5
8.291-8.294	149.9-150.05	2310-2390	15.35-16.2
8.362-8.366	156.52475-156.52525	2483.5-2500	17.7-21.4
8.37625-8.38675	156.7-156.9	2690-2900	22.01-23.12
8.41425-8.41475	162.0125-167.17	3260-3267	23.6-24.0
12.29-12.293	167.72-173.2	3332-3339	31.2-31.8
12.51975-12.52025	240-285	3345.8-3358	36.43-36.5
12.57675-12.57725	322-335.4	3600-4400	(2)
13.36-13.41			

According to FCC Part 15.205, the level of any transmitter spurious emission in Restricted bands shall not exceed the level of the emission specified in the following table

Restricted Frequency(MHz)	Field Strength ($\mu\text{V}/\text{m}$)	Field Strength ($\text{dB}\mu\text{V}/\text{m}$)	Measurement Distance
0.009-0.490	2400/F(KHz)	20 log ($\mu\text{V}/\text{m}$)	300
0.490-1.705	2400/F(KHz)	20 log ($\mu\text{V}/\text{m}$)	30
1.705-30	30	29.5	30
30-88	100	40	3
88-216	150	43.5	3
216-960	200	46	3
Above 960	500	54	3

8.5.3 Test Configuration

Test according to clause 7.2 radio frequency test setup 2

8.5.4 Test Procedure

This test is required for any spurious emission that falls in a Restricted Band, as defined in Section 15.205. It must be performed with the highest gain of each type of antenna proposed for use with the EUT. Use the following spectrum analyzer settings:

The EUT was placed on a turn table which is 0.8m above ground plane.

Maximum procedure was performed on the highest emissions to ensure EUT compliance.

Span = wide enough to fully capture the emission being measured

RBW = 1 MHz for $f \geq 1$ GHz(1GHz to 25GHz), 100 kHz for $f < 1$ GHz(30MHz to 1GHz)

VBW \geq RBW

Sweep = auto
 Detector function = peak
 Trace = max hold

Follow the guidelines in ANSI C63.10-2013 with respect to maximizing the emission by rotating the EUT, measuring the emission while the EUT is situated in three orthogonal planes (if appropriate), adjusting the measurement antenna height and polarization, etc. A pre-amp and a high pass filter are required for this test, in order to provide the measuring system with sufficient sensitivity. Allow the trace to stabilize. The peak reading of the emission, after being corrected by the antenna factor, cable loss, pre-amp gain, etc., is the peak field strength, which must comply with the limit specified in Section 15.35(b). Submit this data.

Now set the VBW to 10 Hz, while maintaining all of the other instrument settings. This peak level, once corrected, must comply with the limit specified in Section 15.209. If the dwell time per channel of the hopping signal is less than 100 ms, then the reading obtained with the 10 Hz VBW may be further adjusted by a "duty cycle correction factor", derived from $20\log(\text{dwell time}/100 \text{ ms})$, in an effort to demonstrate compliance with the 15.209 limit. Submit this data.

Repeat above procedures until all frequency measured was complete.

8.5.5 Test Results

Temperature:	26° C
Relative Humidity:	54%
ATM Pressure:	1011 mbar

■ Spurious Emission below 30MHz (9KHz to 30MHz)

Freq. (MHz)	Ant.Pol. H/V	Emission Level(dBuV/m)		Limit 3m(dBuV/m)		Over(dB)	
		PK	AV	PK	AV	PK	AV
--	--	--	--	--	--	--	--

Note: the amplitude of spurious emission that is attenuated by more than 20dB below the permissible limit has no need to be reported.

Distance extrapolation factor = $40\log(\text{Specific distance}/ \text{test distance})$ (dB);

Limit line = Specific limits(dBuV) + distance extrapolation factor

■ Spurious Emission Above 1GHz (1GHz to 25GHz)

BLE mode have been tested, and the worst result was report as below:

Test mode: BLE Frequency: Channel 0: 2402MHz

Freq. (MHz)	Ant.Pol.	Emission Level(dBuV/m)	Limit 3m(dBuV/m)	Over(dB)	Detector
6653.991	V	46.55	74.00	-27.45	peak
6653.991	V	28.95	54.00	-25.05	AVG
11245.45	V	56.86	74.00	-17.14	peak
11245.45	V	38.52	54.00	-15.48	AVG
17818.82	V	64.34	74.00	-9.66	peak
17818.82	V	46.35	54.00	-7.65	AVG
5689.137	H	44.32	74.00	-29.68	peak
5689.137	H	26.99	54.00	-27.01	AVG
9978.641	H	55.50	74.00	-18.50	peak
9978.641	H	38.52	54.00	-15.48	AVG
17870.40	H	64.80	74.00	-9.20	peak
17870.4	H	46.97	54.00	-7.03	AVG

Test mode: BLE Frequency: Channel 19: 2440MHz

Freq. (MHz)	Ant.Pol.	Emission Level(dBuV/m)	Limit 3m(dBuV/m)	Over(dB)	Detector
6211.646	V	45.30	74.00	-28.70	peak
6211.646	V	28.93	54.00	-25.07	AVG
11154.80	V	56.35	74.00	-17.65	peak
11154.80	V	38.55	54.00	-15.45	AVG
17935.08	V	64.28	74.00	-9.72	peak
17935.08	V	46.78	54.00	-7.22	AVG
5467.470	H	43.42	74.00	-30.58	peak
5467.470	H	25.33	54.00	-28.67	AVG
10692.33	H	54.91	74.00	-19.09	peak
10692.33	H	36.87	54.00	-17.13	AVG
17966.21	H	64.44	74.00	-9.56	peak
17966.21	H	46.33	54.00	-7.67	AVG

Test mode: BLE Frequency: Channel 39: 2480MHz

Freq. (MHz)	Ant.Pol.	Emission Level(dBuV/m)	Limit 3m(dBuV/m)	Over(dB)	Detector
5419.483	V	43.75	74.00	-30.25	peak
5419.483	V	25.79	54.00	-28.21	AVG
11389.38	V	56.34	74.00	-17.66	peak
11389.38	V	38.53	54.00	-15.47	AVG
17901.42	V	64.27	74.00	-9.73	peak
17901.42	V	46.38	54.00	-7.62	AVG
7391.138	H	51.31	74.00	-22.69	peak
7391.138	H	33.29	54.00	-20.71	AVG
11222.72	H	58.08	74.00	-15.92	peak
11222.72	H	40.26	54.00	-13.74	AVG
18000.00	H	64.45	74.00	-9.55	peak
18000	H	46.33	54.00	-7.67	AVG

- Note:** (1) All Readings are Peak Value (VBW=3MHz) and Peak Value (VBW=10Hz).
(2) Emission Level= Reading Level+Correct Factor +Cable Loss.
(3) Correct Factor= Ant_F + Cab_L - Preamp
(4) Data of measurement within this frequency range shown “ -- ” in the table above means the reading of emissions are attenuated more than 20dB below the permissible limits or the field strength is too small to be measured.



■ Spurious Emission in Restricted Band 2310-2390MHz and 2483.5-2500MHz

Test mode: BLE Frequency: Channel 0: 2402MHz

Freq. (MHz)	Ant.Pol.	Emission Level(dBuV/m)	Limit 3m(dBuV/m)	Over(dB)	Detector
2385.892	V	49.35	74.00	-24.65	peak
2385.892	V	31.29	54.00	-22.71	AVG
2390.000	H	49.54	74.00	-24.46	peak
2390	H	31.52	54.00	-22.48	AVG

Test mode: BLE Frequency: Channel 39: 2480MHz

Freq. (MHz)	Ant.Pol.	Emission Level(dBuV/m)	Limit 3m(dBuV/m)	Over(dB)	Detector
2484.538	V	55.94	74.00	-18.06	peak
2484.538	V	38.88	54.00	-15.12	AVG
2484.683	H	54.86	74.00	-19.14	peak
2484.683	H	36.77	54.00	-17.23	AVG

- Note:**
- (1) All Readings are Peak Value (VBW=3MHz) and Peak Value (VBW=10Hz).
 - (2) Emission Level= Reading Level+Correct Factor +Cable Loss.
 - (3) Correct Factor= Ant_F + Cab_L - Preamp
 - (4) Data of measurement within this frequency range shown "--" in the table above means the reading of emissions are attenuated more than 20dB below the permissible limits or the field strength is too small to be measured.

All the modulation modes were tested, the data of the worst mode are described in the following table

Test Model	Spurious Emission in Restricted Band 2310-2390MHz
	BLE
	Channel 0: 2402MHz
	H

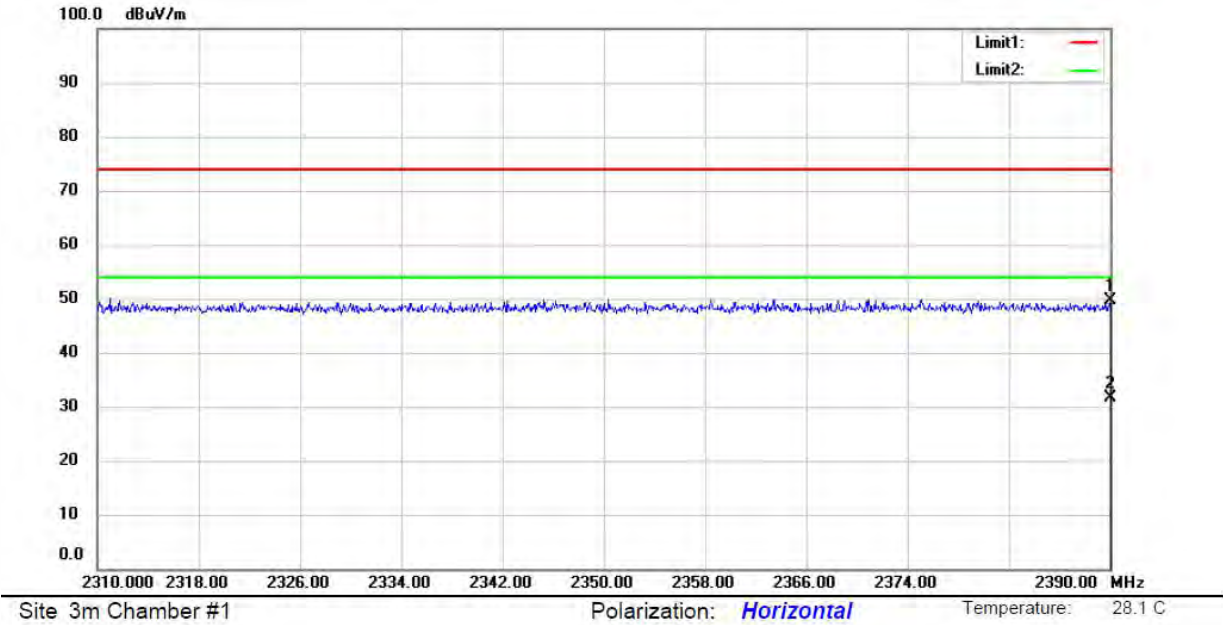

Test Model	Spurious Emission in Restricted Band 2310-2390MHz
	BLE
	Channel 0: 2402MHz
	V

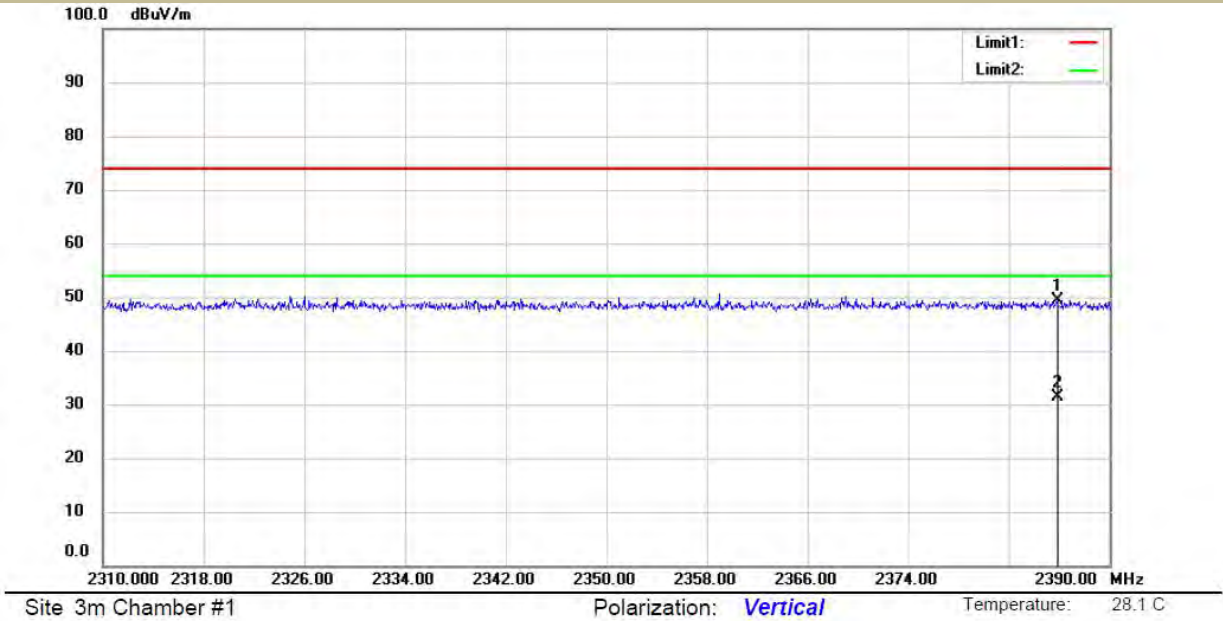

Test Model Spurious Emission in Restricted Band 2483.5-2500MHz
BLE
Channel 39: 2480MHz H

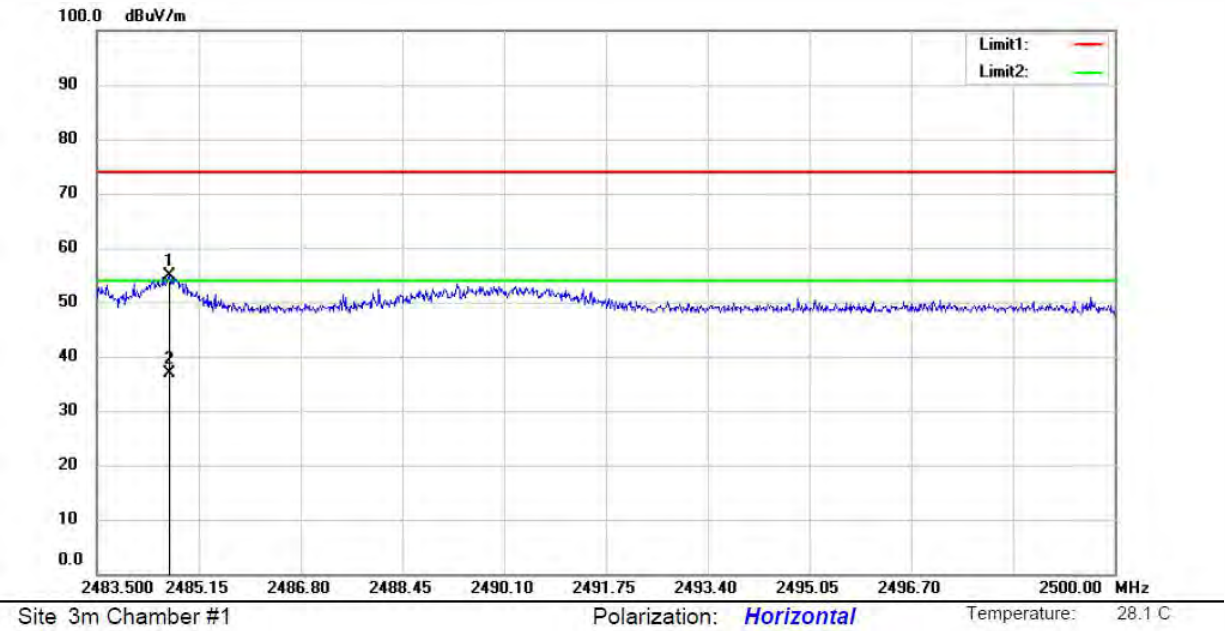

Test Model Spurious Emission in Restricted Band 2483.5-2500MHz
BLE
Channel 39: 2480MHz V

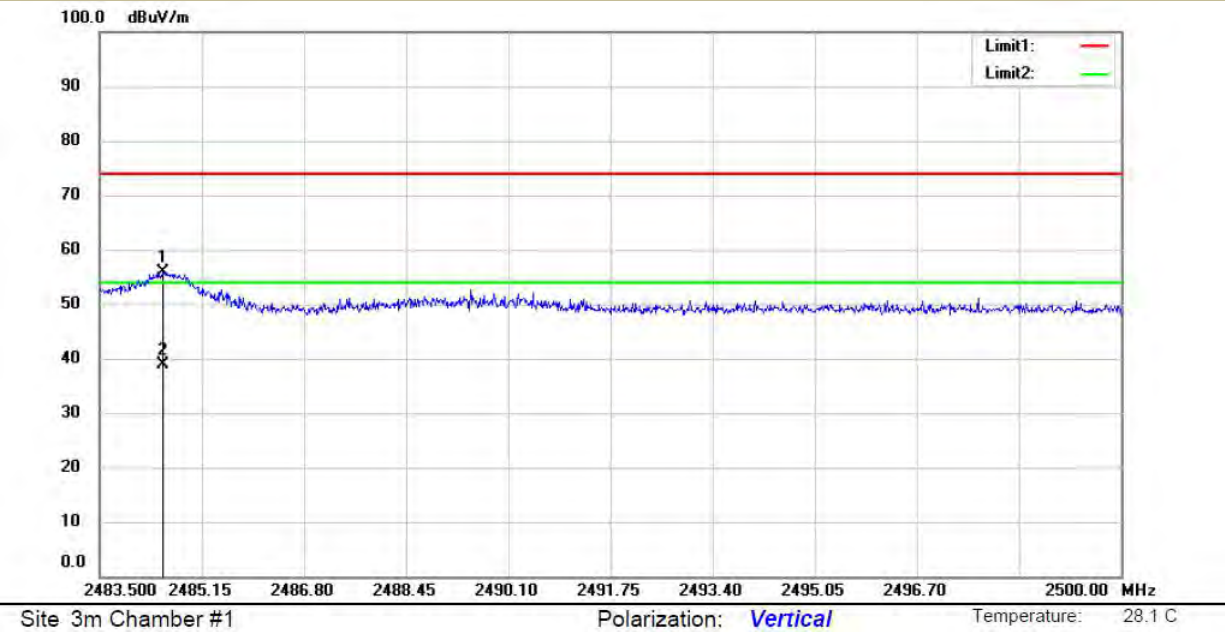

■ Spurious Emission below 1GHz (30MHz to 1GHz)

All modes have been tested, and the worst result recorded was report as below:

Test mode: BLE Frequency: Channel 0: 2402MHz



Site 3m Chamber #1 Polarization: Vertical Temperature: 28.1 C

No.	Mk.	Freq.	Reading Level	Correct Factor	Measurement	Limit	Over	Antenna Height	Table Degree	
		MHz	dBuV	dB	dBuV/m	dBuV/m	dB	cm	degree	Comment
1		50.4090	38.71	-7.49	31.22	40.00	-8.78			QP
2		96.6477	37.27	-10.32	26.95	43.50	-16.55			QP
3		160.0648	35.07	-9.60	25.47	43.50	-18.03			QP
4		274.0736	38.35	-5.92	32.43	46.00	-13.57			QP
5		523.4058	32.91	-1.16	31.75	46.00	-14.25			QP
6	*	828.9455	32.27	6.32	38.59	46.00	-7.41			QP

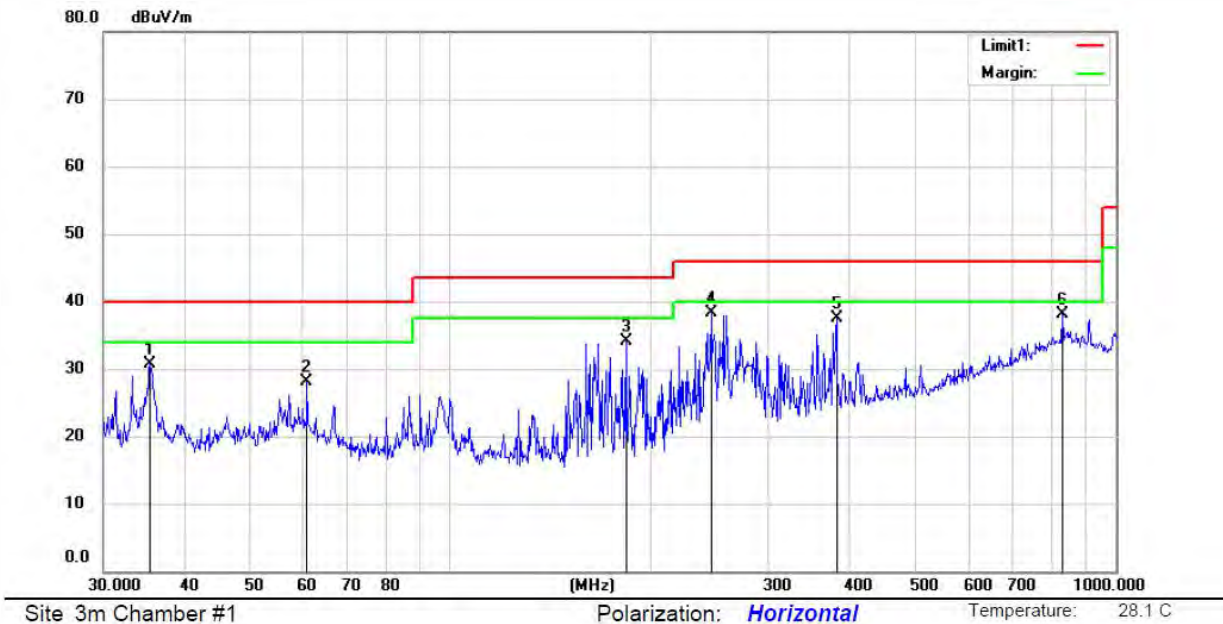

No.	Mk.	Freq. MHz	Reading Level dBuV	Correct Factor dB	Measure- ment dBuV/m	Limit dBuV/m	Over dB	Antenna Height cm	Table Degree degree	Comment
1		35.2976	39.89	-9.11	30.78	40.00	-9.22	QP		
2		60.8375	35.57	-7.44	28.13	40.00	-11.87	QP		
3		183.3611	43.60	-9.58	34.02	43.50	-9.48	QP		
4	*	246.3825	45.81	-7.57	38.24	46.00	-7.76	QP		
5		380.7477	40.78	-3.20	37.58	46.00	-8.42	QP		
6		830.4002	31.66	6.37	38.03	46.00	-7.97	QP		

Test mode: BLE Frequency: Channel 19: 2440MHz

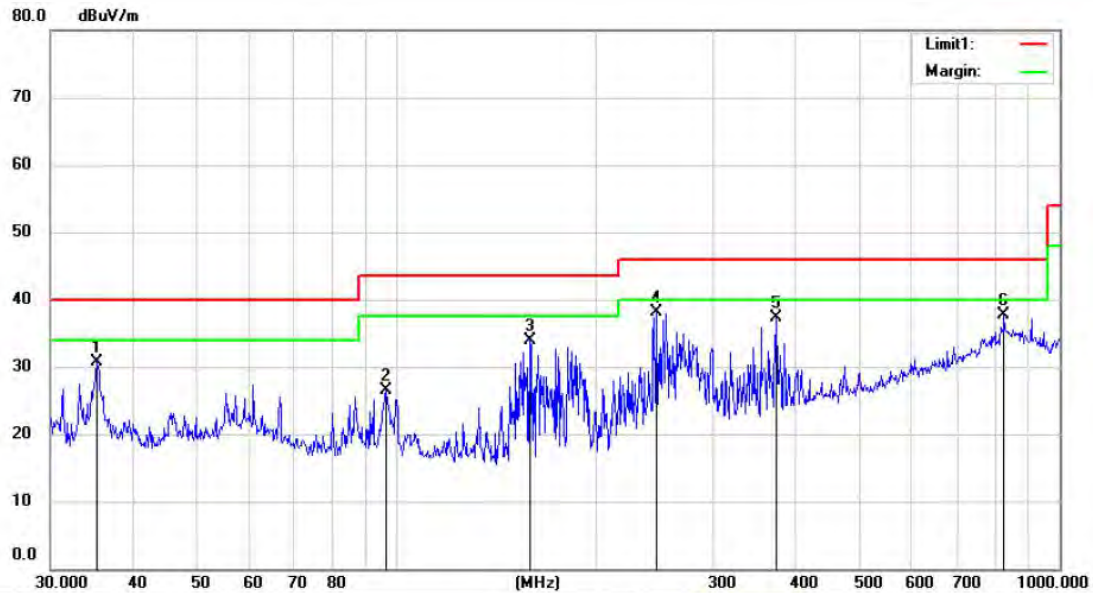

Site 3m Chamber #1 Polarization: *Horizontal* Temperature: 28.1 C

No.	Mk.	Freq.	Reading Level	Correct Factor	Measurement	Limit	Over	Antenna Height	Table Degree	
		MHz	dBuV	dB	dBuV/m	dBuV/m	dB	cm	degree	Comment
1		35.2976	39.90	-9.11	30.79	40.00	-9.21			QP
2		96.3517	36.89	-10.30	26.59	43.50	-16.91			QP
3		158.7373	43.44	-9.63	33.81	43.50	-9.69			QP
4	*	246.5986	45.55	-7.54	38.01	46.00	-7.99			QP
5		373.3112	40.61	-3.37	37.24	46.00	-8.76			QP
6		826.4060	31.60	6.17	37.77	46.00	-8.23			QP



Site 3m Chamber #1 Polarization: *Vertical* Temperature: 28.1 C

No.	Mk.	Freq. MHz	Reading Level dBuV	Correct Factor dB	Measure- ment dBuV/m	Limit dBuV/m	Over dB	Antenna Height cm	Table Degree degree	Comment
1		35.3440	39.47	-9.10	30.37	40.00	-9.63			QP
2		50.4310	37.69	-7.49	30.20	40.00	-9.80			QP
3		95.9723	37.45	-10.29	27.16	43.50	-16.34			QP
4		259.9165	37.20	-6.75	30.45	46.00	-15.55			QP
5		599.3212	33.40	1.07	34.47	46.00	-11.53			QP
6	*	827.1308	32.47	6.21	38.68	46.00	-7.32			QP

Test mode: BLE Frequency: Channel 39: 2480MHz



Site 3m Chamber #1 Polarization: Vertical Temperature: 28.1 C

No.	Mk.	Freq. MHz	Reading Level dBuV	Correct Factor dB	Measure- ment dBuV/m	Limit dBuV/m	Over dB	Antenna Height cm	Table Degree degree	Comment
1	*	35.3440	39.71	-9.10	30.61	40.00	-9.39	QP		
2		99.9653	37.52	-10.43	27.09	43.50	-16.41	QP		
3		159.9947	35.99	-9.59	26.40	43.50	-17.10	QP		
4		282.3656	35.30	-5.80	29.50	46.00	-16.50	QP		
5		598.2713	30.07	1.01	31.08	46.00	-14.92	QP		
6		798.2796	30.52	5.55	36.07	46.00	-9.93	QP		



Site 3m Chamber #1 Polarization: *Horizontal* Temperature: 28.1 C

No.	Mk.	Freq. MHz	Reading Level dBuV	Correct Factor dB	Measure- ment dBuV/m	Limit dBuV/m	Over dB	Antenna Height cm	Table Degree degree	Comment
1		33.1821	38.78	-9.58	29.20	40.00	-10.80			QP
2		98.8326	39.09	-10.39	28.70	43.50	-14.80			QP
3	*	185.6254	44.78	-9.47	35.31	43.50	-8.19			QP
4		254.1707	44.70	-7.01	37.69	46.00	-8.31			QP
5		379.2485	39.36	-3.24	36.12	46.00	-9.88			QP
6		830.0363	30.62	6.37	36.99	46.00	-9.01			QP

8.6 CONDUCTED EMISSIONS TEST

8.6.1 Applicable Standard

According to FCC Part 15.207(a)

8.6.2 Conformance Limit

Frequency(MHz)	Conducted Emission Limit	
	Quasi-peak	Average
0.15-0.5	66-56	56-46
0.5-5.0	56	46
5.0-30.0	60	50

Note: 1. The lower limit shall apply at the transition frequencies
2. The limit decreases in line with the logarithm of the frequency in the range of 0.15 to 0.50MHz.

8.6.3 Test Configuration

Test according to clause 7.3 conducted emission test setup

8.6.4 Test Procedure

The EUT was placed on a table which is 0.8m above ground plane.
Maximum procedure was performed on the highest emissions to ensure EUT compliance.
Repeat above procedures until all frequency measured were complete.

8.6.5 Test Results

Pass

The 120V & 240V voltage have been tested, and the worst result recorded was report as below:

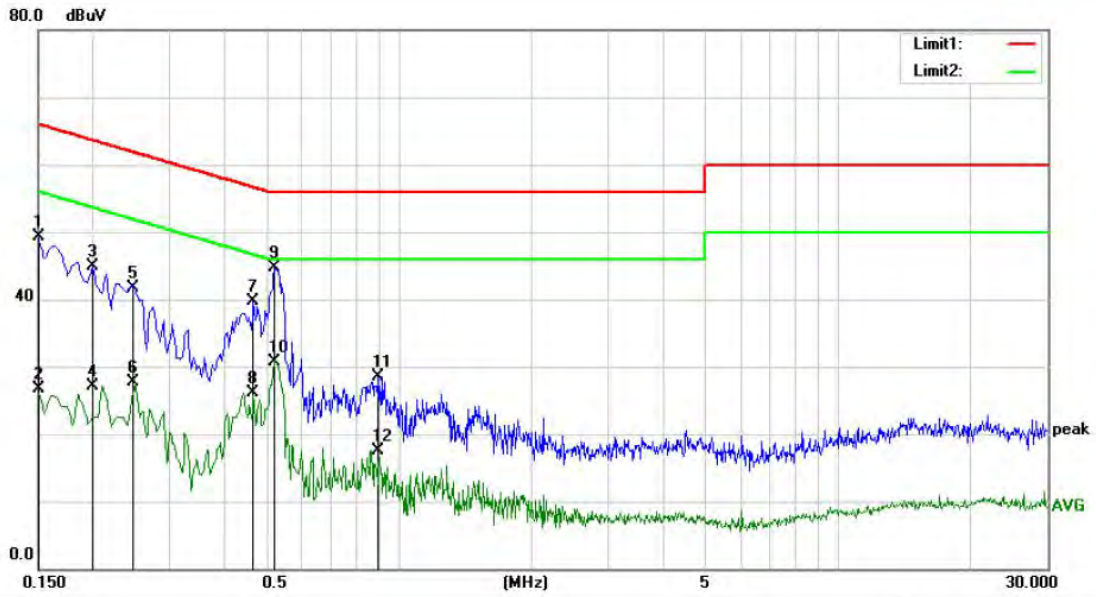

Site Conduction #1 Phase: **N** Temperature: 22.2

No.	Mk.	Freq. MHz	Reading Level dBuV	Correct Factor dB	Measure- ment dBuV	Limit dBuV	Over dB	Detector	Comment
1		0.1500	39.72	9.53	49.25	66.00	-16.75	QP	
2		0.1500	17.21	9.53	26.74	56.00	-29.26	AVG	
3		0.2000	35.29	9.53	44.82	63.61	-18.79	QP	
4		0.2000	17.64	9.53	27.17	53.61	-26.44	AVG	
5		0.2468	32.24	9.53	41.77	61.86	-20.09	QP	
6		0.2468	18.19	9.53	27.72	51.86	-24.14	AVG	
7		0.4650	30.16	9.53	39.69	56.60	-16.91	QP	
8		0.4650	16.60	9.53	26.13	46.60	-20.47	AVG	
9	*	0.5200	35.23	9.53	44.76	56.00	-11.24	QP	
10		0.5200	21.23	9.53	30.76	46.00	-15.24	AVG	
11		0.8950	19.03	9.55	28.58	56.00	-27.42	QP	
12		0.8950	8.04	9.55	17.59	46.00	-28.41	AVG	

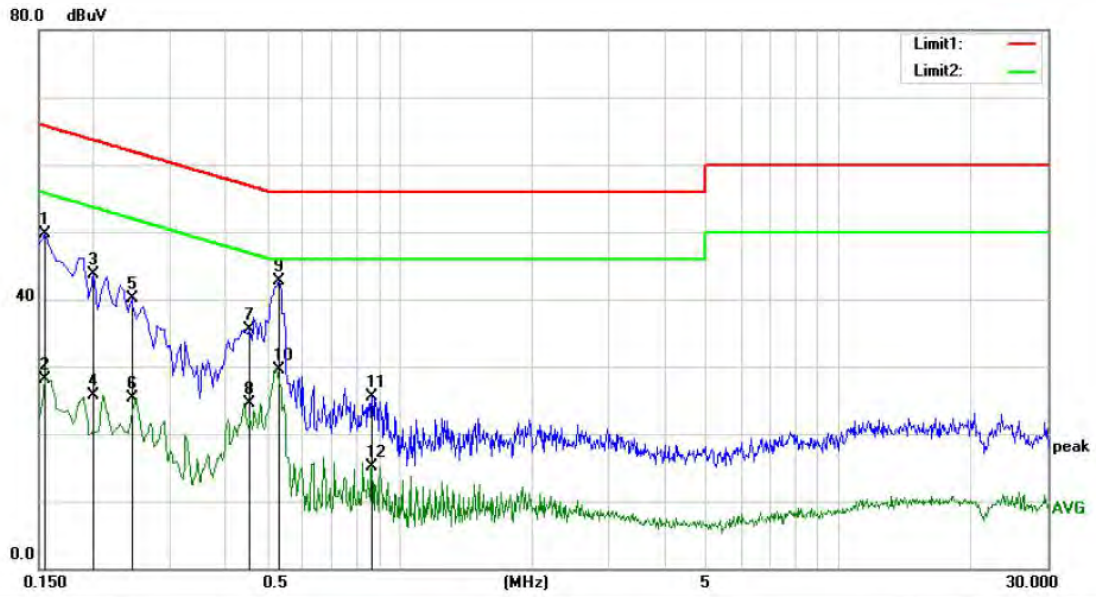

Site Conduction #1		Phase: L1		Temperature: 22.2				
No. Mk.	Freq. MHz	Reading Level dBuV	Correct Factor dB	Measurement dBuV	Limit dBuV	Over dB	Detector	Comment
1	0.1550	40.21	9.53	49.74	65.73	-15.99	QP	
2	0.1550	18.52	9.53	28.05	55.73	-27.68	AVG	
3	0.2000	34.10	9.53	43.63	63.61	-19.98	QP	
4	0.2000	16.27	9.53	25.80	53.61	-27.81	AVG	
5	0.2450	30.51	9.53	40.04	61.92	-21.88	QP	
6	0.2450	15.87	9.53	25.40	51.92	-26.52	AVG	
7	0.4550	26.05	9.53	35.58	56.78	-21.20	QP	
8	0.4550	14.96	9.53	24.49	46.78	-22.29	AVG	
9 *	0.5300	33.14	9.53	42.67	56.00	-13.33	QP	
10	0.5300	20.05	9.53	29.58	46.00	-16.42	AVG	
11	0.8650	15.92	9.55	25.47	56.00	-30.53	QP	
12	0.8650	5.61	9.55	15.16	46.00	-30.84	AVG	

8.7 ANTENNA APPLICATION

8.7.1 Antenna Requirement

Standard	Requirement
FCC CRF Part 15.203	An intentional radiator shall be designed to ensure that no antenna other than that furnished by the responsible party shall be used with the device. The use of a permanently attached antenna or of an antenna that uses a unique coupling to the intentional radiator shall be considered sufficient to comply with the provisions of this section. The manufacturer may design the unit so that a broken antenna can be replaced by the user, but the use of a standard antenna jack or electrical connector is prohibited. This requirement does not apply to carrier current devices or to devices operated under the provisions of §15.211, §15.213, §15.217, §15.219, or §15.221. Further, this requirement does not apply to intentional radiators that must be professionally installed, such as perimeter protection systems and some field disturbance sensors, or to other intentional radiators which, in accordance with §15.31(d), must be measured at the installation site. However, the installer shall be responsible for ensuring that the proper antenna is employed so that the limits in this part are not exceeded.

For intentional device, according to FCC 47 CFR Section 15.203, an intentional radiator shall be designed to ensure that no antenna other than that furnished by the responsible party shall be used with the device. And according to FCC 47 CFR Section 15.247 (b), if transmitting antennas of directional gain greater than 6dBi are used, the power shall be reduced by the amount in dB that the directional gain of the antenna exceeds 6dBi.

8.7.2 Result

PASS.

The EUT is PCB antenna, the antenna gain is 2.5dBi.

- Note:
- Antenna use a permanently attached antenna which is not replaceable.
 - Not using a standard antenna jack or electrical connector for antenna replacement
 - The antenna has to be professionally installed (please provide method of installation)

which in accordance to section 15.203, please refer to the internal photos.

Detail of factor for radiated emission

Frequency(MHz)	Ant_F(dB)	Cab_L(dB)	Preamp(dB)	Correct Factor(dB)
0.009	20.6	0.03	\	20.63
0.15	20.7	0.1	\	20.8
1	20.9	0.15	\	21.05
10	20.1	0.28	\	20.38
30	18.8	0.45	\	19.25
30	11.7	0.62	27.9	-15.58
100	12.5	1.02	27.8	-14.28
300	12.9	1.91	27.5	-12.69
600	19.2	2.92	27	-4.88
800	21.1	3.54	26.6	-1.96
1000	22.3	4.17	26.2	0.27
1000	25.6	1.76	41.4	-14.04
3000	28.9	3.27	43.2	-11.03
5000	31.1	4.2	44.6	-9.3
8000	36.2	5.95	44.7	-2.55
10000	38.4	6.3	43.9	0.8
12000	38.5	7.14	42.3	3.34
15000	40.2	8.15	41.4	6.95
18000	45.4	9.02	41.3	13.12
18000	37.9	1.81	47.9	-8.19
21000	37.9	1.95	48.7	-8.85
25000	39.3	2.01	42.8	-1.49
28000	39.6	2.16	46.0	-4.24
31000	41.2	2.24	44.5	-1.06
34000	41.5	2.29	46.6	-2.81
37000	43.8	2.30	46.4	-0.3
40000	43.2	2.50	42.2	3.5

--- End of Report ---