

TEST REPORT

CERTIFICATE OF CONFORMITY

Standard: 47 CFR FCC Part 22
47 CFR FCC Part 24
47 CFR FCC Part 27
47 CFR FCC Part 90
47 CFR FCC Part 2

Report No.: RFBDKX-WTW-P23090081

FCC ID: 2ATIO5

Product: Home IOT Gateway

Brand: Level

Model No.: H5

Series Model: H2

Received Date: 2023/8/31

Test Date: 2023/8/31 ~ 2023/11/8

Issued Date: 2023/12/8

Applicant: Level Home Inc.

Address: 935 Main Street, Redwood City, California 94063, United States of America

Issued By: Bureau Veritas Consumer Products Services (H.K.) Ltd., Taoyuan Branch
Lin Kou Laboratories

Lab Address: No. 47-2, 14th Ling, Chia Pau Vil., Lin Kou Dist., New Taipei City, Taiwan

Test Location (1): No. 19, Hwa Ya 2nd Rd., Wen Hwa Vil., Kwei Shan Dist., Taoyuan City 33383, TAIWAN

FCC Registration /

Designation Number: 788550 / TW0003

Test Location (2): No. 70, Wenming Rd., Guishan Dist., Taoyuan City 333, Taiwan (R.O.C.)

FCC Registration /

Designation Number: 281270 / TW0032

Approved by: Jeremy Lin , **Date:** 2023/12/8
Jeremy Lin / Project Engineer

This test report consists of 380 pages in total. It may be duplicated completely for legal use with the approval of the applicant. It should not be reproduced except in full, without the written approval of our laboratory. The test results in the report only apply to the tested sample. The test results in this report are traceable to the national or international standards.



Prepared by : Pettie Chen / Senior Specialist

This report is governed by, and incorporates by reference, the Conditions of Testing as posted at the date of issuance of this report at <http://www.bureauveritas.com/home/about-us/our-business/cps/about-us/terms-conditions/> and is intended for your exclusive use. Any copying or replication of this report to or for any other person or entity, or use of our name or trademark, is permitted only with our prior written permission. This report sets forth our findings solely with respect to the test samples identified herein. The results set forth in this report are not indicative or representative of the quality or characteristics of the lot from which a test sample was taken or any similar or identical product unless specifically and expressly noted. Our report includes all of the tests requested by you and the results thereof based upon the information that you provided to us. Measurement uncertainty is only provided upon request for accredited tests. Statements of conformity are based on simple acceptance criteria without taking measurement uncertainty into account, unless otherwise requested in writing. You have 60 days from date of issuance of this report to notify us of any material error or omission caused by our negligence or if you require measurement uncertainty; provided, however, that such notice shall be in writing and shall specifically address the issue you wish to raise. A failure to raise such issue within the prescribed time shall constitute your unqualified acceptance of the completeness of this report, the tests conducted and the correctness of the report contents.

Table of Contents

Release Control Record	5
1 Certificate	6
2 Summary of Test Results	7
2.1 Measurement Uncertainty	9
2.2 Supplementary Information	9
3 General Information	10
3.1 General Description of EUT	10
3.2 Antenna Description of EUT	13
3.3 Test Mode Applicability and Tested Channel Detail	14
3.4 Test Program Used and Operation Descriptions	32
3.5 Connection Diagram of EUT and Peripheral Devices	32
3.6 Configuration of Peripheral Devices and Cable Connections	32
4 Test Instruments	33
4.1 Effective Radiated Power and Equivalent Isotropically Radiated Power	33
4.2 Modulation Characteristics	33
4.3 Peak to Average Ratio	33
4.4 Bandwidth	33
4.5 Conducted Spurious Emissions	33
4.6 Radiated Spurious Emissions below 1GHz	34
4.7 Radiated Spurious Emissions above 1GHz	35
4.8 Frequency Stability	36
5 Limits of Test Items	37
5.1 Effective Radiated Power and Equivalent Isotropically Radiated Power	37
5.2 Modulation Characteristics	37
5.3 Peak to Average Ratio	37
5.4 Bandwidth	37
5.5 Conducted Spurious Emissions	37
5.6 Radiated Spurious Emissions below 1GHz	38
5.7 Radiated Spurious Emissions above 1GHz	38
5.8 Frequency Stability	38
6 Test Arrangements	39
6.1 Effective Radiated Power and Equivalent Isotropically Radiated Power	39
6.1.1 Test Setup	39
6.1.2 Test Procedure	39
6.2 Modulation Characteristics	40
6.2.1 Test Setup	40
6.2.2 Test Procedure	40
6.3 Peak to Average Ratio	40
6.3.1 Test Setup	40
6.3.2 Test Procedure	40
6.4 Bandwidth	41
6.4.1 Test Setup	41
6.4.2 Test Procedure	41
6.5 Conducted Spurious Emissions	43
6.5.1 Test Setup	43
6.5.2 Test Procedure	43
6.6 Radiated Spurious Emissions below 1GHz	44
6.6.1 Test Setup	44
6.6.2 Test Procedure	44
6.7 Radiated Spurious Emissions above 1GHz	45
6.7.1 Test Setup	45
6.7.2 Test Procedure	45
6.8 Frequency Stability	46
6.8.1 Test Setup	46



6.8.2	Test Procedure.....	46
7	Test Results of Test Item.....	47
7.1	Effective Radiated Power and Equivalent Isotropically Radiated Power.....	47
7.1.1	WCDMA Band 2.....	47
7.1.2	WCDMA Band 4.....	48
7.1.3	WCDMA Band 5.....	49
7.1.4	LTE Band 2.....	50
7.1.5	LTE Band 4.....	56
7.1.6	LTE Band 5.....	62
7.1.7	LTE Band 12.....	66
7.1.8	LTE Band 25.....	70
7.1.9	LTE Band 26 (814 MHz ~ 824 MHz).....	76
7.1.10	LTE Band 26 (824 MHz ~ 849 MHz).....	80
7.2	Modulation Characteristics.....	86
7.2.1	WCDMA Band 2.....	86
7.2.2	WCDMA Band 4.....	87
7.2.3	WCDMA Band 5.....	88
7.2.4	LTE Band 2.....	89
7.2.5	LTE Band 4.....	89
7.2.6	LTE Band 5.....	89
7.2.7	LTE Band 12.....	90
7.2.8	LTE Band 25.....	90
7.2.9	LTE Band 26 (814 MHz ~ 824 MHz).....	90
7.2.10	LTE Band 26 (824 MHz ~ 849 MHz).....	91
7.3	Peak to Average Ratio.....	92
7.3.1	WCDMA Band 2.....	92
7.3.2	WCDMA Band 4.....	93
7.3.3	WCDMA Band 5.....	94
7.3.4	LTE Band 2.....	95
7.3.5	LTE Band 4.....	101
7.3.6	LTE Band 5.....	107
7.3.7	LTE Band 12.....	111
7.3.8	LTE Band 25.....	115
7.3.9	LTE Band 26 (824 MHz ~ 849 MHz).....	121
7.4	Bandwidth.....	126
7.4.1	WCDMA Band 2.....	126
7.4.2	WCDMA Band 4.....	127
7.4.3	WCDMA Band 5.....	128
7.4.4	LTE Band 2.....	129
7.4.5	LTE Band 4.....	135
7.4.6	LTE Band 5.....	141
7.4.7	LTE Band 12.....	145
7.4.8	LTE Band 25.....	149
7.4.9	LTE Band 26 (814 MHz ~ 824 MHz).....	155
7.4.10	LTE Band 26 (824 MHz ~ 849 MHz).....	159
7.5	Conducted Spurious Emissions.....	164
7.5.1	WCDMA Band 2.....	164
7.5.2	WCDMA Band 4.....	170
7.5.3	WCDMA Band 5.....	176
7.5.4	LTE Band 2.....	182
7.5.5	LTE Band 4.....	194
7.5.6	LTE Band 5.....	206
7.5.7	LTE Band 12.....	214
7.5.8	LTE Band 25.....	222
7.5.9	LTE Band 26 (814 MHz ~ 824 MHz).....	234
7.5.10	LTE Band 26 (824 MHz ~ 849 MHz).....	241
7.6	Radiated Spurious Emissions below 1GHz.....	251
7.6.1	WCDMA Band 2.....	251
7.6.2	WCDMA Band 4.....	253
7.6.3	WCDMA Band 5.....	255



7.6.4	LTE Band 2	257
7.6.5	LTE Band 4	259
7.6.6	LTE Band 5	261
7.6.7	LTE Band 12	263
7.6.8	LTE Band 25	265
7.6.9	LTE Band 26 (814 MHz ~ 824 MHz).....	267
7.6.10	LTE Band 26 (824 MHz ~ 849 MHz).....	269
7.7	Radiated Spurious Emissions above 1GHz	271
7.7.1	WCDMA Band 2	271
7.7.2	WCDMA Band 4	274
7.7.3	WCDMA Band 5	277
7.7.4	LTE Band 2	280
7.7.5	LTE Band 4	289
7.7.6	LTE Band 5	298
7.7.7	LTE Band 12	307
7.7.8	LTE Band 25	316
7.7.9	LTE Band 26 (814 MHz ~ 824 MHz).....	325
7.7.10	LTE Band 26 (824 MHz ~ 849 MHz).....	332
7.8	Frequency Stability	341
7.8.1	WCDMA Band 2	341
7.8.2	WCDMA Band 4	342
7.8.3	WCDMA Band 5	343
7.8.4	LTE Band 2	344
7.8.5	LTE Band 4	350
7.8.6	LTE Band 5	356
7.8.7	LTE Band 12	360
7.8.8	LTE Band 25	364
7.8.9	LTE Band 26 (814 MHz ~ 824 MHz).....	370
7.8.10	LTE Band 26 (824 MHz ~ 849 MHz).....	374
8	Pictures of Test Arrangements	379
9	Information of the Testing Laboratories	380



Release Control Record

Issue No.	Description	Date Issued
RFBDKX-WTW-P23090081	Original release.	2023/12/8

1 Certificate

Product: Home IOT Gateway

Brand: Level

Model No.: H5

Series Model: H2

Sample Status: Engineering sample

Applicant: Level Home Inc.

Test Date: 2023/8/31 ~ 2023/11/8

Standard: 47 CFR FCC Part 22
47 CFR FCC Part 24
47 CFR FCC Part 27
47 CFR FCC Part 90
47 CFR FCC Part 2

Measurement procedure: ANSI/TIA/EIA-603-E 2016
ANSI C63.26-2015
KDB 971168 D01 Power Meas License Digital Systems v03r01
KDB 971168 D02 Misc Rev Approv License Devices v02r01

The above equipment has been tested by **Bureau Veritas Consumer Products Services (H.K.) Ltd., Taoyuan Branch**, and found compliance with the requirement of the above standards. The test record, data evaluation & Equipment Under Test (EUT) configurations represented herein are true and accurate accounts of the measurements of the sample's RF characteristics under the conditions specified in this report.

2 Summary of Test Results

47 CFR FCC Part 22 47 CFR FCC Part 24 47 CFR FCC Part 27 47 CFR FCC Part 90 47 CFR FCC Part 2			
Standard / Clause	Test Item	Result	Remark
FCC 47 CFR Part 2.1046 FCC 47 CFR Part 22.913 (a) FCC 47 CFR Part 24.232 (c) FCC 47 CFR Part 27.50(d) FCC 47 CFR Part 27.50(c) FCC 47 CFR Part 90.635(b)	Effective Radiated Power and Equivalent Isotropically Radiated Power	Pass	Meet the requirement of limit.
FCC 47 CFR Part 2.1047	Modulation Characteristics	Pass	Meet the requirement of limit.
FCC 47 CFR Part 22.913 (d) FCC 47 CFR Part 24.232 (d) FCC 47 CFR Part 27.50(d)	Peak to Average Ratio	Pass	Meet the requirement of limit.
FCC 47 CFR Part 2.1049	Bandwidth	Pass	Meet the requirement of limit.
FCC 47 CFR Part 2.1051 FCC 47 CFR Part 22.917 FCC 47 CFR Part 24.238 FCC 47 CFR Part 27.53(h) FCC 47 CFR Part 27.53(g) FCC 47 CFR Part 90.691	Conducted Spurious Emissions	Pass	Meet the requirement of limit.
FCC 47 CFR Part 2.1053 FCC 47 CFR Part 22.917 FCC 47 CFR Part 24.238 FCC 47 CFR Part 27.53(h) FCC 47 CFR Part 27.53(g) FCC 47 CFR Part 90.691	Radiated Spurious Emissions below 1GHz	Pass	Minimum passing margin is -32.92 dB at 49.40 MHz



47 CFR FCC Part 22
47 CFR FCC Part 24
47 CFR FCC Part 27
47 CFR FCC Part 90
47 CFR FCC Part 2

Standard / Clause	Test Item	Result	Remark
FCC 47 CFR Part 2.1053 FCC 47 CFR Part 22.917 FCC 47 CFR Part 24.238 FCC 47 CFR Part 27.53(h) FCC 47 CFR Part 27.53(g) FCC 47 CFR Part 90.691	Radiated Spurious Emissions above 1GHz	Pass	Minimum passing margin is -14.12 dB at 1672.80, 1638.00 MHz
FCC 47 CFR Part 2.1055 FCC 47 CFR Part 22.355 FCC 47 CFR Part 24.235 FCC 47 CFR Part 27.54 FCC 47 CFR Part 90.213	Frequency Stability	Pass	Meet the requirement of limit.

Note: Determining compliance based on the results of the compliance measurement, not taking into account measurement instrumentation uncertainty.

2.1 Measurement Uncertainty

Where relevant, the following measurement uncertainty levels have been estimated for tests performed on the EUT as specified in CISPR 16-4-2:

Measurement	Specification	Expanded Uncertainty (k=2) (±)
Radiated Spurious Emissions below 1GHz	9 kHz ~ 30 MHz	3.00 dB
	30 MHz ~ 1 GHz	2.93 dB
Radiated Spurious Emissions above 1GHz	1 GHz ~ 18 GHz	1.76 dB
	18 GHz ~ 40 GHz	1.77 dB

The other instruments specified are routine verified to remain within the calibrated levels, no measurement uncertainty is required to be calculated.

2.2 Supplementary Information

There is not any deviation from the test standards for the test method, and no modifications required for compliance.

3 General Information

3.1 General Description of EUT

Product	Home IOT Gateway
Brand	Level
Test Model	H5
Series Model	H2
Model Difference	Refer to Note
Status of EUT	Engineering sample
Power Supply Rating	5Vdc (From adapter) 3.6Vdc (From battery)

Note:

1. All models are listed as below.

RF Radio List	Radio ID	Technology List	H5	H2
1	LTE	WWAN (LTE + WCDMA)	V	V
2	Z-Wave	Z-wave	V	X
	Thread 900M	Thread 900M	V(Optional)	V
3	Thread	Thread	V(Optional)	V
	Zigbee	Zigbee	V	X
	BLE	BTLE	V	V
4	WiFi	WLAN(2.4G)	V	X
	BLE-SOM	BLE	V	V

2. EUT Overview

Band / Bandwidth	TX Frequency Range (MHz)	Max. EIRP Power	Emission Designator
WCDMA Band 2	1852.4-1907.6	356.451mW (25.52dBm)	4M14F9W
WCDMA Band 4	1712.4-1752.6	459.198mW (26.62dBm)	4M14F9W
Band / Bandwidth	TX Frequency Range (MHz)	Max. ERP Power	Emission Designator
WCDMA Band 5	826.4-846.6	68.234mW (18.34dBm)	4M16F9W

Band / Bandwidth	TX Frequency Range (MHz)	Max. ERP Power		Emission Designator		
		QPSK	16QAM	QPSK	16QAM	
LTE Band 5 (Channel Bandwidth 1.4MHz)	824.7-848.3	68.077mW (18.33dBm)	56.494mW (17.52dBm)	1M09G7D	1M09D7W	
LTE Band 5 (Channel Bandwidth 3MHz)	825.5-847.5	64.863mW (18.12dBm)	50.582mW (17.04dBm)	2M70G7D	2M70D7W	
LTE Band 5 (Channel Bandwidth 5MHz)	826.5-846.5	64.121mW (18.07dBm)	48.084mW (16.82dBm)	4M50G7D	4M49D7W	
LTE Band 5 (Channel Bandwidth 10MHz)	829.0-844.0	67.143mW (18.27dBm)	49.774mW (16.97dBm)	8M96G7D	4M57D7W	
LTE Band 12 (Channel Bandwidth 1.4MHz)	699.7-715.3	60.814mW (17.84dBm)	49.888mW (16.98dBm)	1M09G7D	1M09D7W	
LTE Band 12 (Channel Bandwidth 3MHz)	700.5-714.5	59.979mW (17.78dBm)	43.551mW (16.39dBm)	2M70G7D	2M70D7W	
LTE Band 12 (Channel Bandwidth 5MHz)	701.5-713.5	57.943mW (17.63dBm)	45.394mW (16.57dBm)	4M49G7D	4M49D7W	
LTE Band 12 (Channel Bandwidth 10MHz)	704.0-711.0	58.884mW (17.70dBm)	47.315mW (16.75dBm)	8M97G7D	4M57D7W	
For Part 22	LTE Band 26 (Channel Bandwidth 1.4MHz)	824.7-848.3	61.660mW (17.90dBm)	53.580mW (17.29dBm)	1M09G7D	1M09D7W
	LTE Band 26 (Channel Bandwidth 3MHz)	825.5-847.5	61.376mW (17.88dBm)	53.088mW (17.25dBm)	2M70G7D	2M70D7W
	LTE Band 26 (Channel Bandwidth 5MHz)	826.5-846.5	60.954mW (17.85dBm)	49.091mW (16.91dBm)	4M50G7D	4M49D7W
	LTE Band 26 (Channel Bandwidth 10MHz)	829.0-844.0	61.518mW (17.89dBm)	51.761mW (17.14dBm)	8M96G7D	4M57D7W
	LTE Band 26 (Channel Bandwidth 15MHz)	831.5-841.5	61.944mW (17.92dBm)	51.286mW (17.10dBm)	13M4G7D	4M68D7W
For Part 90	LTE Band 26 (Channel Bandwidth 1.4MHz)	814.7-823.3	109.648mW (20.40dBm)	86.896mW (19.39dBm)	1M09G7D	1M09D7W
	LTE Band 26 (Channel Bandwidth 3MHz)	815.5-822.5	106.414mW (20.27dBm)	87.902mW (19.44dBm)	2M70G7D	2M70D7W
	LTE Band 26 (Channel Bandwidth 5MHz)	816.5-821.5	110.154mW (20.42dBm)	88.716mW (19.48dBm)	4M49G7D	4M49D7W
	LTE Band 26 (Channel Bandwidth 10MHz)	819.0	110.662mW (20.44dBm)	85.507mW (19.32dBm)	8M95G7D	4M57D7W

Band / Bandwidth	TX Frequency Range (MHz)	Max. EIRP Power		Emission Designator	
		QPSK	16QAM	QPSK	16QAM
LTE Band 2 (Channel Bandwidth 1.4MHz)	1850.7-1909.3	378.443mW (25.78dBm)	304.789mW (24.84dBm)	1M09G7D	1M09D7W
LTE Band 2 (Channel Bandwidth 3MHz)	1851.5-1908.5	379.315mW (25.79dBm)	291.743mW (24.65dBm)	2M70G7D	2M70D7W
LTE Band 2 (Channel Bandwidth 5MHz)	1852.5-1907.5	362.243mW (25.59dBm)	281.190mW (24.49dBm)	4M50G7D	4M49D7W
LTE Band 2 (Channel Bandwidth 10MHz)	1855.0-1905.0	363.915mW (25.61dBm)	334.965mW (25.25dBm)	8M97G7D	4M57D7W
LTE Band 2 (Channel Bandwidth 15MHz)	1857.5-1902.5	377.572mW (25.77dBm)	306.902mW (24.87dBm)	13M4G7D	4M67D7W
LTE Band 2 (Channel Bandwidth 20MHz)	1860.0-1900.0	385.478mW (25.86dBm)	359.749mW (25.56dBm)	17M9G7D	4M81D7W
LTE Band 4 (Channel Bandwidth 1.4MHz)	1710.7-1754.3	426.580mW (26.30dBm)	348.337mW (25.42dBm)	1M09G7D	1M09D7W
LTE Band 4 (Channel Bandwidth 3MHz)	1711.5-1753.5	420.727mW (26.24dBm)	375.837mW (25.75dBm)	2M70G7D	2M70D7W
LTE Band 4 (Channel Bandwidth 5MHz)	1712.5-1752.5	408.319mW (26.11dBm)	331.894mW (25.21dBm)	4M50G7D	4M49D7W
LTE Band 4 (Channel Bandwidth 10MHz)	1715.0-1750.0	414.954mW (26.18dBm)	359.749mW (25.56dBm)	8M96G7D	4M57D7W
LTE Band 4 (Channel Bandwidth 15MHz)	1717.5-1747.5	435.512mW (26.39dBm)	351.560mW (25.46dBm)	13M4G7D	4M67D7W
LTE Band 4 (Channel Bandwidth 20MHz)	1720.0-1745.0	444.631mW (26.48dBm)	361.410mW (25.58dBm)	17M9G7D	4M81D7W
LTE Band 25 (Channel Bandwidth 1.4MHz)	1850.7-1914.3	375.837mW (25.75dBm)	291.743mW (24.65dBm)	1M09G7D	1M09D7W
LTE Band 25 (Channel Bandwidth 3MHz)	1851.5-1913.5	351.560mW (25.46dBm)	279.254mW (24.46dBm)	2M70G7D	2M70D7W
LTE Band 25 (Channel Bandwidth 5MHz)	1852.5-1912.5	371.535mW (25.70dBm)	292.415mW (24.66dBm)	4M50G7D	4M49D7W
LTE Band 25 (Channel Bandwidth 10MHz)	1855.0-1910.0	371.535mW (25.70dBm)	283.792mW (24.53dBm)	8M97G7D	4M57D7W
LTE Band 25 (Channel Bandwidth 15MHz)	1857.5-1907.5	368.129mW (25.66dBm)	309.030mW (24.90dBm)	13M5G7D	4M68D7W
LTE Band 25 (Channel Bandwidth 20MHz)	1860.0-1905.0	381.944mW (25.82dBm)	295.121mW (24.70dBm)	17M9G7D	4M82D7W

3. For WWAN 16QAM modulation bandwidths \geq 10MHz, EUT only supports up to 25RB.

4. The EUT uses following accessories.

Battery		
Brand	Model	Specification
Grand-Pro	INR18650	Power Rating: 3.6V 3350mah/ 12.06Wh
Adapter		
Brand	Model	Specification
CUI INC	SWH15-5B-N	AC Input: 100-240Vac, 50/60Hz, 0.5A Max DC Output: 5.0Vdc, 3.0A DC Output Cable: 1.8m non-shielded without core
LAN cable		
Brand	Model	Specification
NA	NA	1.0m non-shielded without core

5. The above EUT information is declared by manufacturer and for more detailed features description, please refers to the manufacturer's specifications or user's manual.

3.2 Antenna Description of EUT

1. The antenna information is listed as below.

Antenna Type				PIFA										
Antenna Connector				NA										
Frequency (MHz)	700	750	800	850	900	1700	1750	1800	1850	1900	1950	2000	2100	2150
Main Ant. Gain (dBi) (TX/RX)	-3.21	-1.48	-0.66	-3.22	-3.95	3.87	3.77	4.08	3.38	2.76	1.67	0.72	0.51	-0.43
Aux. Ant. Gain (dBi) (RX)	0.12	0.93	0.05	-0.42	-3.05	0.13	0.44	-0.47	-0.72	1.88	2.45	2.49	-0.99	-2.50

* Main Antenna was for the final tests.

* Detail antenna specification please refer to antenna datasheet and/or antenna measurement report.

3.3 Test Mode Applicability and Tested Channel Detail

Pre-Scan:	EUT can be used in the following ways: X-axis/ Y-axis/ Z-axis. Pre-scan these ways and find the worst case as a representative test condition.
Worst Case:	X-axis/ Y-axis/ Z-axis Worst Condition: Y-axis

For WCDMA Band 2

Test Item	Tested Channel	Channel Bandwidth	Modulation	Mode
EIRP	9262 (1852.40 MHz) 9400 (1880.00 MHz) 9538 (1907.60 MHz)	-	-	WCDMA HSDPA HSUPA
Modulation Characteristics	9400 (1880.00 MHz)	-	-	WCDMA HSDPA HSUPA
Occupied Bandwidth	9262 (1852.40 MHz) 9400 (1880.00 MHz) 9538 (1907.60 MHz)	-	-	WCDMA HSDPA HSUPA
Peak to Average Ratio	9262 (1852.40 MHz) 9400 (1880.00 MHz) 9538 (1907.60 MHz)	-	-	WCDMA HSDPA HSUPA
Conducted Emission	9262 (1852.40 MHz) 9400 (1880.00 MHz) 9538 (1907.60 MHz)	-	-	WCDMA HSDPA HSUPA
Radiated Spurious Emissions below 1GHz	9538 (1907.60 MHz)	-	-	WCDMA
Radiated Spurious Emissions above 1GHz	9262 (1852.40 MHz) 9400 (1880.00 MHz) 9538 (1907.60 MHz)	-	-	WCDMA
Frequency Stability	9262 (1852.40 MHz) 9538 (1907.60 MHz)	-	-	WCDMA

For WCDMA Band 4

Test Item	Tested Channel	Channel Bandwidth	Modulation	Mode
EIRP	1312 (1712.40 MHz) 1413 (1732.60 MHz) 1513 (1752.60 MHz)	-	-	WCDMA HSDPA HSUPA
Modulation Characteristics	1413 (1732.60 MHz)	-	-	WCDMA HSDPA HSUPA
Occupied Bandwidth	1312 (1712.40 MHz) 1413 (1732.60 MHz) 1513 (1752.60 MHz)	-	-	WCDMA HSDPA HSUPA
Peak to Average Ratio	1312 (1712.40 MHz) 1413 (1732.60 MHz) 1513 (1752.60 MHz)	-	-	WCDMA HSDPA HSUPA
Conducted Emission	1312 (1712.40 MHz) 1413 (1732.60 MHz) 1513 (1752.60 MHz)	-	-	WCDMA HSDPA HSUPA
Radiated Spurious Emissions below 1GHz	1413 (1732.60 MHz)	-	-	WCDMA
Radiated Spurious Emissions above 1GHz	1312 (1712.40 MHz) 1413 (1732.60 MHz) 1513 (1752.60 MHz)	-	-	WCDMA
Frequency Stability	1312 (1712.40 MHz) 1513 (1752.60 MHz)	-	-	WCDMA

For WCDMA Band 5

Test Item	Tested Channel	Channel Bandwidth	Modulation	Mode
ERP	4132 (826.40 MHz) 4182 (836.40 MHz) 4233 (846.60 MHz)	-	-	WCDMA HSDPA HSUPA
Modulation Characteristics	4182 (836.40 MHz)	-	-	WCDMA HSDPA HSUPA
Occupied Bandwidth	4132 (826.40 MHz) 4182 (836.40 MHz) 4233 (846.60 MHz)	-	-	WCDMA HSDPA HSUPA
Peak to Average Ratio	4132 (826.40 MHz) 4182 (836.40 MHz) 4233 (846.60 MHz)	-	-	WCDMA HSDPA HSUPA
Conducted Emission	4132 (826.40 MHz) 4182 (836.40 MHz) 4233 (846.60 MHz)	-	-	WCDMA HSDPA HSUPA
Radiated Spurious Emissions below 1GHz	4182 (836.40 MHz)	-	-	WCDMA
Radiated Spurious Emissions above 1GHz	4132 (826.40 MHz) 4182 (836.40 MHz) 4233 (846.60 MHz)	-	-	WCDMA
Frequency Stability	4132 (826.40 MHz) 4233 (846.60 MHz)	-	-	WCDMA

For LTE Band 2

Test Item	Tested Channel	Channel Bandwidth	Modulation	Mode
EIRP	18607 (1850.70 MHz) 18900 (1880.00 MHz) 19193 (1909.30 MHz)	1.4 MHz	QPSK / 16QAM	1 RB Half RB Full RB
	18615 (1851.50 MHz) 18900 (1880.00 MHz) 19185 (1908.50 MHz)	3 MHz	QPSK / 16QAM	1 RB Half RB Full RB
	18625 (1852.50 MHz) 18900 (1880.00 MHz) 19175 (1907.50 MHz)	5 MHz	QPSK / 16QAM	1 RB Half RB Full RB
	18650 (1855.00 MHz) 18900 (1880.00 MHz) 19150 (1905.00 MHz)	10 MHz	QPSK / 16QAM	1 RB Half RB Full RB
	18675 (1857.50 MHz) 18900 (1880.00 MHz) 19125 (1902.50 MHz)	15 MHz	QPSK / 16QAM	1 RB Half RB Full RB
	18700 (1860.00 MHz) 18900 (1880.00 MHz) 19100 (1900.00 MHz)	20 MHz	QPSK / 16QAM	1 RB Half RB Full RB
Modulation Characteristics	18900 (1880.00 MHz)	20 MHz	QPSK / 16QAM	Full RB
Occupied Bandwidth	18607 (1850.70 MHz) 18900 (1880.00 MHz) 19193 (1909.30 MHz)	1.4 MHz	QPSK / 16QAM	Full RB
	18615 (1851.50 MHz) 18900 (1880.00 MHz) 19185 (1908.50 MHz)	3 MHz	QPSK / 16QAM	Full RB
	18625 (1852.50 MHz) 18900 (1880.00 MHz) 19175 (1907.50 MHz)	5 MHz	QPSK / 16QAM	Full RB
	18650 (1855.00 MHz) 18900 (1880.00 MHz) 19150 (1905.00 MHz)	10 MHz	QPSK / 16QAM	Full RB
	18675 (1857.50 MHz) 18900 (1880.00 MHz) 19125 (1902.50 MHz)	15 MHz	QPSK / 16QAM	Full RB
	18700 (1860.00 MHz) 18900 (1880.00 MHz) 19100 (1900.00 MHz)	20 MHz	QPSK / 16QAM	Full RB



Test Item	Tested Channel	Channel Bandwidth	Modulation	Mode
Peak to Average Ratio	18607 (1850.70 MHz) 18900 (1880.00 MHz) 19193 (1909.30 MHz)	1.4 MHz	QPSK / 16QAM	1 RB
	18615 (1851.50 MHz) 18900 (1880.00 MHz) 19185 (1908.50 MHz)	3 MHz	QPSK / 16QAM	1 RB
	18625 (1852.50 MHz) 18900 (1880.00 MHz) 19175 (1907.50 MHz)	5 MHz	QPSK / 16QAM	1 RB
	18650 (1855.00 MHz) 18900 (1880.00 MHz) 19150 (1905.00 MHz)	10 MHz	QPSK / 16QAM	1 RB
	18675 (1857.50 MHz) 18900 (1880.00 MHz) 19125 (1902.50 MHz)	15 MHz	QPSK / 16QAM	1 RB
	18700 (1860.00 MHz) 18900 (1880.00 MHz) 19100 (1900.00 MHz)	20 MHz	QPSK / 16QAM	1 RB
Conducted Emission	18607 (1850.70 MHz) 18900 (1880.00 MHz) 19193 (1909.30 MHz)	1.4 MHz	QPSK	1 RB Full RB
	18615 (1851.50 MHz) 18900 (1880.00 MHz) 19185 (1908.50 MHz)	3 MHz	QPSK	1 RB Full RB
	18625 (1852.50 MHz) 18900 (1880.00 MHz) 19175 (1907.50 MHz)	5 MHz	QPSK	1 RB Full RB
	18650 (1855.00 MHz) 18900 (1880.00 MHz) 19150 (1905.00 MHz)	10 MHz	QPSK	1 RB Full RB
	18675 (1857.50 MHz) 18900 (1880.00 MHz) 19125 (1902.50 MHz)	15 MHz	QPSK	1 RB Full RB
	18700 (1860.00 MHz) 18900 (1880.00 MHz) 19100 (1900.00 MHz)	20 MHz	QPSK	1 RB Full RB

Test Item	Tested Channel	Channel Bandwidth	Modulation	Mode
Radiated Spurious Emissions below 1GHz	19193 (1909.30 MHz)	1.4 MHz	QPSK	1 RB
Radiated Spurious Emissions above 1GHz	18607 (1850.70 MHz) 18900 (1880.00 MHz) 19193 (1909.30 MHz)	1.4 MHz	QPSK	1 RB
	18625 (1852.50 MHz) 18900 (1880.00 MHz) 19175 (1907.50 MHz)	5 MHz	QPSK	1 RB
	18700 (1860.00 MHz) 18900 (1880.00 MHz) 19100 (1900.00 MHz)	20 MHz	QPSK	1 RB
Frequency Stability	18607 (1850.70 MHz) 19193 (1909.30 MHz)	1.4 MHz	QPSK	Full RB
	18615 (1851.50 MHz) 19185 (1908.50 MHz)	3 MHz	QPSK	Full RB
	18625 (1852.50 MHz) 19175 (1907.50 MHz)	5 MHz	QPSK	Full RB
	18650 (1855.00 MHz) 19150 (1905.00 MHz)	10 MHz	QPSK	Full RB
	18675 (1857.50 MHz) 19125 (1902.50 MHz)	15 MHz	QPSK	Full RB
	18700 (1860.00 MHz) 19100 (1900.00 MHz)	20 MHz	QPSK	Full RB

For LTE Band 4

Test Item	Tested Channel	Channel Bandwidth	Modulation	Mode
EIRP	19957 (1710.70 MHz) 20175 (1732.50 MHz) 20393 (1754.30 MHz)	1.4 MHz	QPSK / 16QAM	1 RB Half RB Full RB
	19965 (1711.50 MHz) 20175 (1732.50 MHz) 20385 (1753.50 MHz)	3 MHz	QPSK / 16QAM	1 RB Half RB Full RB
	19975 (1712.50 MHz) 20175 (1732.50 MHz) 20375 (1752.50 MHz)	5 MHz	QPSK / 16QAM	1 RB Half RB Full RB
	20000 (1715.00 MHz) 20175 (1732.50 MHz) 20350 (1750.00 MHz)	10 MHz	QPSK / 16QAM	1 RB Half RB Full RB
	20025 (1717.50 MHz) 20175 (1732.50 MHz) 20325 (1747.50 MHz)	15 MHz	QPSK / 16QAM	1 RB Half RB Full RB
	20050 (1720.00 MHz) 20175 (1732.50 MHz) 20300 (1745.00 MHz)	20 MHz	QPSK / 16QAM	1 RB Half RB Full RB
Modulation Characteristics	20175 (1732.50 MHz)	20 MHz	QPSK / 16QAM	Full RB
Occupied Bandwidth	19957 (1710.70 MHz) 20175 (1732.50 MHz) 20393 (1754.30 MHz)	1.4 MHz	QPSK / 16QAM	Full RB
	19965 (1711.50 MHz) 20175 (1732.50 MHz) 20385 (1753.50 MHz)	3 MHz	QPSK / 16QAM	Full RB
	19975 (1712.50 MHz) 20175 (1732.50 MHz) 20375 (1752.50 MHz)	5 MHz	QPSK / 16QAM	Full RB
	20000 (1715.00 MHz) 20175 (1732.50 MHz) 20350 (1750.00 MHz)	10 MHz	QPSK / 16QAM	Full RB
	20025 (1717.50 MHz) 20175 (1732.50 MHz) 20325 (1747.50 MHz)	15 MHz	QPSK / 16QAM	Full RB
	20050 (1720.00 MHz) 20175 (1732.50 MHz) 20300 (1745.00 MHz)	20 MHz	QPSK / 16QAM	Full RB

Test Item	Tested Channel	Channel Bandwidth	Modulation	Mode
Peak to Average Ratio	19957 (1710.70 MHz) 20175 (1732.50 MHz) 20393 (1754.30 MHz)	1.4 MHz	QPSK / 16QAM	1 RB
	19965 (1711.50 MHz) 20175 (1732.50 MHz) 20385 (1753.50 MHz)	3 MHz	QPSK / 16QAM	1 RB
	19975 (1712.50 MHz) 20175 (1732.50 MHz) 20375 (1752.50 MHz)	5 MHz	QPSK / 16QAM	1 RB
	20000 (1715.00 MHz) 20175 (1732.50 MHz) 20350 (1750.00 MHz)	10 MHz	QPSK / 16QAM	1 RB
	20025 (1717.50 MHz) 20175 (1732.50 MHz) 20325 (1747.50 MHz)	15 MHz	QPSK / 16QAM	1 RB
	20050 (1720.00 MHz) 20175 (1732.50 MHz) 20300 (1745.00 MHz)	20 MHz	QPSK / 16QAM	1 RB
Conducted Emission	19957 (1710.70 MHz) 20175 (1732.50 MHz) 20393 (1754.30 MHz)	1.4 MHz	QPSK	1 RB Full RB
	19965 (1711.50 MHz) 20175 (1732.50 MHz) 20385 (1753.50 MHz)	3 MHz	QPSK	1 RB Full RB
	19975 (1712.50 MHz) 20175 (1732.50 MHz) 20375 (1752.50 MHz)	5 MHz	QPSK	1 RB Full RB
	20000 (1715.00 MHz) 20175 (1732.50 MHz) 20350 (1750.00 MHz)	10 MHz	QPSK	1 RB Full RB
	20025 (1717.50 MHz) 20175 (1732.50 MHz) 20325 (1747.50 MHz)	15 MHz	QPSK	1 RB Full RB
	20050 (1720.00 MHz) 20175 (1732.50 MHz) 20300 (1745.00 MHz)	20 MHz	QPSK	1 RB Full RB
Radiated Spurious Emissions below 1GHz	20050 (1720.00 MHz)	20 MHz	QPSK	1 RB
Radiated Spurious Emissions above 1GHz	19957 (1710.70 MHz) 20175 (1732.50 MHz) 20393 (1754.30 MHz)	1.4 MHz	QPSK	1 RB
	19975 (1712.50 MHz) 20175 (1732.50 MHz) 20375 (1752.50 MHz)	5 MHz	QPSK	1 RB
	20050 (1720.00 MHz) 20175 (1732.50 MHz) 20300 (1745.00 MHz)	20 MHz	QPSK	1 RB



Test Item	Tested Channel	Channel Bandwidth	Modulation	Mode
Frequency Stability	19957 (1710.70 MHz) 20393 (1754.30 MHz)	1.4 MHz	QPSK	Full RB
	19965 (1711.50 MHz) 20385 (1753.50 MHz)	3 MHz	QPSK	Full RB
	19975 (1712.50 MHz) 20375 (1752.50 MHz)	5 MHz	QPSK	Full RB
	20000 (1715.00 MHz) 20350 (1750.00 MHz)	10 MHz	QPSK	Full RB
	20025 (1717.50 MHz) 20325 (1747.50 MHz)	15 MHz	QPSK	Full RB
	20050 (1720.00 MHz) 20300 (1745.00 MHz)	20 MHz	QPSK	Full RB

For LTE Band 5

Test Item	Tested Channel	Channel Bandwidth	Modulation	Mode
ERP	20407 (824.70 MHz) 20525 (836.50 MHz) 20643 (848.30 MHz)	1.4 MHz	QPSK / 16QAM	1 RB Half RB Full RB
	20415 (825.50 MHz) 20525 (836.50 MHz) 20635 (847.50 MHz)	3 MHz	QPSK / 16QAM	1 RB Half RB Full RB
	20425 (826.50 MHz) 20525 (836.50 MHz) 20625 (846.50 MHz)	5 MHz	QPSK / 16QAM	1 RB Half RB Full RB
	20450 (829.00 MHz) 20525 (836.50 MHz) 20600 (844.00 MHz)	10 MHz	QPSK / 16QAM	1 RB Half RB Full RB
Modulation Characteristics	20525 (836.50 MHz)	10 MHz	QPSK / 16QAM	Full RB
Occupied Bandwidth	20407 (824.70 MHz) 20525 (836.50 MHz) 20643 (848.30 MHz)	1.4 MHz	QPSK / 16QAM	Full RB
	20415 (825.50 MHz) 20525 (836.50 MHz) 20635 (847.50 MHz)	3 MHz	QPSK / 16QAM	Full RB
	20425 (826.50 MHz) 20525 (836.50 MHz) 20625 (846.50 MHz)	5 MHz	QPSK / 16QAM	Full RB
	20450 (829.00 MHz) 20525 (836.50 MHz) 20600 (844.00 MHz)	10 MHz	QPSK / 16QAM	Full RB
Peak to Average Ratio	20407 (824.70 MHz) 20525 (836.50 MHz) 20643 (848.30 MHz)	1.4 MHz	QPSK / 16QAM	1 RB
	20415 (825.50 MHz) 20525 (836.50 MHz) 20635 (847.50 MHz)	3 MHz	QPSK / 16QAM	1 RB
	20425 (826.50 MHz) 20525 (836.50 MHz) 20625 (846.50 MHz)	5 MHz	QPSK / 16QAM	1 RB
	20450 (829.00 MHz) 20525 (836.50 MHz) 20600 (844.00 MHz)	10 MHz	QPSK / 16QAM	1 RB
Conducted Emission	20407 (824.70 MHz) 20525 (836.50 MHz) 20643 (848.30 MHz)	1.4 MHz	QPSK	1 RB Full RB
	20415 (825.50 MHz) 20525 (836.50 MHz) 20635 (847.50 MHz)	3 MHz	QPSK	1 RB Full RB
	20425 (826.50 MHz) 20525 (836.50 MHz) 20625 (846.50 MHz)	5 MHz	QPSK	1 RB Full RB
	20450 (829.00 MHz) 20525 (836.50 MHz) 20600 (844.00 MHz)	10 MHz	QPSK	1 RB Full RB

Test Item	Tested Channel	Channel Bandwidth	Modulation	Mode
Radiated Spurious Emissions below 1GHz	20600 (844.00 MHz)	10 MHz	QPSK	1 RB
Radiated Spurious Emissions above 1GHz	20407 (824.70 MHz) 20525 (836.50 MHz) 20643 (848.30 MHz)	1.4 MHz	QPSK	1 RB
	20425 (826.50 MHz) 20525 (836.50 MHz) 20625 (846.50 MHz)	5 MHz	QPSK	1 RB
	20450 (829.00 MHz) 20525 (836.50 MHz) 20600 (844.00 MHz)	10 MHz	QPSK	1 RB
Frequency Stability	20407 (824.70 MHz) 20643 (848.30 MHz)	1.4 MHz	QPSK	Full RB
	20415 (825.50 MHz) 20635 (847.50 MHz)	3 MHz	QPSK	Full RB
	20425 (826.50 MHz) 20625 (846.50 MHz)	5 MHz	QPSK	Full RB
	20450 (829.00 MHz) 20600 (844.00 MHz)	10 MHz	QPSK	Full RB

For LTE Band 12

Test Item	Tested Channel	Channel Bandwidth	Modulation	Mode
ERP	23017 (699.70 MHz) 23095 (707.50 MHz) 23173 (715.30 MHz)	1.4 MHz	QPSK / 16QAM	1 RB Half RB Full RB
	23025 (700.50 MHz) 23095 (707.50 MHz) 23165 (714.50 MHz)	3 MHz	QPSK / 16QAM	1 RB Half RB Full RB
	23035 (701.50 MHz) 23095 (707.50 MHz) 23155 (713.50 MHz)	5 MHz	QPSK / 16QAM	1 RB Half RB Full RB
	23060 (704.00 MHz) 23095 (707.50 MHz) 23130 (711.00 MHz)	10 MHz	QPSK / 16QAM	1 RB Half RB Full RB
Modulation Characteristics	23095 (707.50 MHz)	10 MHz	QPSK / 16QAM	Full RB
Occupied Bandwidth	23017 (699.70 MHz) 23095 (707.50 MHz) 23173 (715.30 MHz)	1.4 MHz	QPSK / 16QAM	Full RB
	23025 (700.50 MHz) 23095 (707.50 MHz) 23165 (714.50 MHz)	3 MHz	QPSK / 16QAM	Full RB
	23035 (701.50 MHz) 23095 (707.50 MHz) 23155 (713.50 MHz)	5 MHz	QPSK / 16QAM	Full RB
	23060 (704.00 MHz) 23095 (707.50 MHz) 23130 (711.00 MHz)	10 MHz	QPSK / 16QAM	Full RB
Peak to Average Ratio	23017 (699.70 MHz) 23095 (707.50 MHz) 23173 (715.30 MHz)	1.4 MHz	QPSK / 16QAM	1 RB
	23025 (700.50 MHz) 23095 (707.50 MHz) 23165 (714.50 MHz)	3 MHz	QPSK / 16QAM	1 RB
	23035 (701.50 MHz) 23095 (707.50 MHz) 23155 (713.50 MHz)	5 MHz	QPSK / 16QAM	1 RB
	23060 (704.00 MHz) 23095 (707.50 MHz) 23130 (711.00 MHz)	10 MHz	QPSK / 16QAM	1 RB
Conducted Emission	23017 (699.70 MHz) 23095 (707.50 MHz) 23173 (715.30 MHz)	1.4 MHz	QPSK	1 RB Full RB
	23025 (700.50 MHz) 23095 (707.50 MHz) 23165 (714.50 MHz)	3 MHz	QPSK	1 RB Full RB
	23035 (701.50 MHz) 23095 (707.50 MHz) 23155 (713.50 MHz)	5 MHz	QPSK	1 RB Full RB
	23060 (704.00 MHz) 23095 (707.50 MHz) 23130 (711.00 MHz)	10 MHz	QPSK	1 RB Full RB



Test Item	Tested Channel	Channel Bandwidth	Modulation	Mode
Radiated Spurious Emissions below 1GHz	23095 (707.50 MHz)	1.4 MHz	QPSK	1 RB
Radiated Spurious Emissions above 1GHz	23017 (699.70 MHz) 23095 (707.50 MHz) 23173 (715.30 MHz)	1.4 MHz	QPSK	1 RB
	23035 (701.50 MHz) 23095 (707.50 MHz) 23155 (713.50 MHz)	5 MHz	QPSK	1 RB
	23060 (704.00 MHz) 23095 (707.50 MHz) 23130 (711.00 MHz)	10 MHz	QPSK	1 RB
Frequency Stability	23017 (699.70 MHz) 23173 (715.30 MHz)	1.4 MHz	QPSK	Full RB
	23025 (700.50 MHz) 23165 (714.50 MHz)	3 MHz	QPSK	Full RB
	23035 (701.50 MHz) 23155 (713.50 MHz)	5 MHz	QPSK	Full RB
	23060 (704.00 MHz) 23130 (711.00 MHz)	10 MHz	QPSK	Full RB

For LTE Band 25

Test Item	Tested Channel	Channel Bandwidth	Modulation	Mode
EIRP	26047 (1850.70 MHz) 26365 (1882.50 MHz) 26683 (1914.30 MHz)	1.4 MHz	QPSK / 16QAM	1 RB Half RB Full RB
	26055 (1851.50 MHz) 26365 (1882.50 MHz) 26675 (1913.50 MHz)	3 MHz	QPSK / 16QAM	1 RB Half RB Full RB
	26065 (1852.50 MHz) 26365 (1882.50 MHz) 26665 (1912.50 MHz)	5 MHz	QPSK / 16QAM	1 RB Half RB Full RB
	26090 (1855.00 MHz) 26365 (1882.50 MHz) 26640 (1910.00 MHz)	10 MHz	QPSK / 16QAM	1 RB Half RB Full RB
	26115 (1857.50 MHz) 26365 (1882.50 MHz) 26615 (1907.50 MHz)	15 MHz	QPSK / 16QAM	1 RB Half RB Full RB
	26140 (1860.00 MHz) 26365 (1882.50 MHz) 26590 (1905.00 MHz)	20 MHz	QPSK / 16QAM	1 RB Half RB Full RB
Modulation Characteristics	26365 (1882.50 MHz)	20 MHz	QPSK / 16QAM	Full RB
Occupied Bandwidth	26047 (1850.70 MHz) 26365 (1882.50 MHz) 26683 (1914.30 MHz)	1.4 MHz	QPSK / 16QAM	Full RB
	26055 (1851.50 MHz) 26365 (1882.50 MHz) 26675 (1913.50 MHz)	3 MHz	QPSK / 16QAM	Full RB
	26065 (1852.50 MHz) 26365 (1882.50 MHz) 26665 (1912.50 MHz)	5 MHz	QPSK / 16QAM	Full RB
	26090 (1855.00 MHz) 26365 (1882.50 MHz) 26640 (1910.00 MHz)	10 MHz	QPSK / 16QAM	Full RB
	26115 (1857.50 MHz) 26365 (1882.50 MHz) 26615 (1907.50 MHz)	15 MHz	QPSK / 16QAM	Full RB
	26140 (1860.00 MHz) 26365 (1882.50 MHz) 26590 (1905.00 MHz)	20 MHz	QPSK / 16QAM	Full RB

Test Item	Tested Channel	Channel Bandwidth	Modulation	Mode
Peak to Average Ratio	26047 (1850.70 MHz) 26365 (1882.50 MHz) 26683 (1914.30 MHz)	1.4 MHz	QPSK / 16QAM	1 RB
	26055 (1851.50 MHz) 26365 (1882.50 MHz) 26675 (1913.50 MHz)	3 MHz	QPSK / 16QAM	1 RB
	26065 (1852.50 MHz) 26365 (1882.50 MHz) 26665 (1912.50 MHz)	5 MHz	QPSK / 16QAM	1 RB
	26090 (1855.00 MHz) 26365 (1882.50 MHz) 26640 (1910.00 MHz)	10 MHz	QPSK / 16QAM	1 RB
	26115 (1857.50 MHz) 26365 (1882.50 MHz) 26615 (1907.50 MHz)	15 MHz	QPSK / 16QAM	1 RB
	26140 (1860.00 MHz) 26365 (1882.50 MHz) 26590 (1905.00 MHz)	20 MHz	QPSK / 16QAM	1 RB
Conducted Emission	26047 (1850.70 MHz) 26365 (1882.50 MHz) 26683 (1914.30 MHz)	1.4 MHz	QPSK	1 RB Full RB
	26055 (1851.50 MHz) 26365 (1882.50 MHz) 26675 (1913.50 MHz)	3 MHz	QPSK	1 RB Full RB
	26065 (1852.50 MHz) 26365 (1882.50 MHz) 26665 (1912.50 MHz)	5 MHz	QPSK	1 RB Full RB
	26090 (1855.00 MHz) 26365 (1882.50 MHz) 26640 (1910.00 MHz)	10 MHz	QPSK	1 RB Full RB
	26115 (1857.50 MHz) 26365 (1882.50 MHz) 26615 (1907.50 MHz)	15 MHz	QPSK	1 RB Full RB
	26140 (1860.00 MHz) 26365 (1882.50 MHz) 26590 (1905.00 MHz)	20 MHz	QPSK	1 RB Full RB
Radiated Spurious Emissions below 1GHz	26665 (1912.50 MHz)	5 MHz	QPSK	1 RB
Radiated Spurious Emissions above 1GHz	26047 (1850.70 MHz) 26365 (1882.50 MHz) 26683 (1914.30 MHz)	1.4 MHz	QPSK	1 RB
	26065 (1852.50 MHz) 26365 (1882.50 MHz) 26665 (1912.50 MHz)	5 MHz	QPSK	1 RB
	26140 (1860.00 MHz) 26365 (1882.50 MHz) 26590 (1905.00 MHz)	20 MHz	QPSK	1 RB



Test Item	Tested Channel	Channel Bandwidth	Modulation	Mode
Frequency Stability	26047 (1850.70 MHz) 26683 (1914.30 MHz)	1.4 MHz	QPSK	Full RB
	26055 (1851.50 MHz) 26675 (1913.50 MHz)	3 MHz	QPSK	Full RB
	26065 (1852.50 MHz) 26665 (1912.50 MHz)	5 MHz	QPSK	Full RB
	26090 (1855.00 MHz) 26640 (1910.00 MHz)	10 MHz	QPSK	Full RB
	26115 (1857.50 MHz) 26615 (1907.50 MHz)	15 MHz	QPSK	Full RB
	26140 (1860.00 MHz) 26590 (1905.00 MHz)	20 MHz	QPSK	Full RB

For LTE Band 26 (Part 22)

Test Item	Tested Channel	Channel Bandwidth	Modulation	Mode
ERP	26797 (824.70 MHz) 26915 (836.50 MHz) 27033 (848.30 MHz)	1.4 MHz	QPSK / 16QAM	1 RB Half RB Full RB
	26805 (825.50 MHz) 26915 (836.50 MHz) 27025 (847.50 MHz)	3 MHz	QPSK / 16QAM	1 RB Half RB Full RB
	26815 (826.50 MHz) 26915 (836.50 MHz) 27015 (846.50 MHz)	5 MHz	QPSK / 16QAM	1 RB Half RB Full RB
	26840 (829.00 MHz) 26915 (836.50 MHz) 26990 (844.00 MHz)	10 MHz	QPSK / 16QAM	1 RB Half RB Full RB
	26865 (831.50 MHz) 26915 (836.50 MHz) 26965 (841.50 MHz)	15 MHz	QPSK / 16QAM	1 RB Half RB Full RB
Modulation Characteristics	26915 (836.50 MHz)	15 MHz	QPSK / 16QAM	Full RB
Occupied Bandwidth	26797 (824.70 MHz) 26915 (836.50 MHz) 27033 (848.30 MHz)	1.4 MHz	QPSK / 16QAM	Full RB
	26805 (825.50 MHz) 26915 (836.50 MHz) 27025 (847.50 MHz)	3 MHz	QPSK / 16QAM	Full RB
	26815 (826.50 MHz) 26915 (836.50 MHz) 27015 (846.50 MHz)	5 MHz	QPSK / 16QAM	Full RB
	26840 (829.00 MHz) 26915 (836.50 MHz) 26990 (844.00 MHz)	10 MHz	QPSK / 16QAM	Full RB
	26865 (831.50 MHz) 26915 (836.50 MHz) 26965 (841.50 MHz)	15 MHz	QPSK / 16QAM	Full RB

Test Item	Tested Channel	Channel Bandwidth	Modulation	Mode
Peak to Average Ratio	26797 (824.70 MHz) 26915 (836.50 MHz) 27033 (848.30 MHz)	1.4 MHz	QPSK / 16QAM	1 RB
	26805 (825.50 MHz) 26915 (836.50 MHz) 27025 (847.50 MHz)	3 MHz	QPSK / 16QAM	1 RB
	26815 (826.50 MHz) 26915 (836.50 MHz) 27015 (846.50 MHz)	5 MHz	QPSK / 16QAM	1 RB
	26840 (829.00 MHz) 26915 (836.50 MHz) 26990 (844.00 MHz)	10 MHz	QPSK / 16QAM	1 RB
	26865 (831.50 MHz) 26915 (836.50 MHz) 26965 (841.50 MHz)	15 MHz	QPSK / 16QAM	1 RB
Conducted Emission	26797 (824.70 MHz) 26915 (836.50 MHz) 27033 (848.30 MHz)	1.4 MHz	QPSK	1 RB Full RB
	26805 (825.50 MHz) 26915 (836.50 MHz) 27025 (847.50 MHz)	3 MHz	QPSK	1 RB Full RB
	26815 (826.50 MHz) 26915 (836.50 MHz) 27015 (846.50 MHz)	5 MHz	QPSK	1 RB Full RB
	26840 (829.00 MHz) 26915 (836.50 MHz) 26990 (844.00 MHz)	10 MHz	QPSK	1 RB Full RB
	26865 (831.50 MHz) 26915 (836.50 MHz) 26965 (841.50 MHz)	15 MHz	QPSK	1 RB Full RB
Radiated Spurious Emissions below 1GHz	27033 (848.30 MHz)	1.4 MHz	QPSK	1 RB
Radiated Spurious Emissions above 1GHz	26797 (824.70 MHz) 26915 (836.50 MHz) 27033 (848.30 MHz)	1.4 MHz	QPSK	1 RB
	26815 (826.50 MHz) 26915 (836.50 MHz) 27015 (846.50 MHz)	5 MHz	QPSK	1 RB
	26865 (831.50 MHz) 26915 (836.50 MHz) 26965 (841.50 MHz)	15 MHz	QPSK	1 RB
Frequency Stability	26797 (824.70 MHz) 27033 (848.30 MHz)	1.4 MHz	QPSK	Full RB
	26805 (825.50 MHz) 27025 (847.50 MHz)	3 MHz	QPSK	Full RB
	26815 (826.50 MHz) 27015 (846.50 MHz)	5 MHz	QPSK	Full RB
	26840 (829.00 MHz) 26990 (844.00 MHz)	10 MHz	QPSK	Full RB
	26865 (831.50 MHz) 26965 (841.50 MHz)	15 MHz	QPSK	Full RB

For LTE Band 26 (Part 90)

Test Item	Tested Channel	Channel Bandwidth	Modulation	Mode
ERP	26697 (814.70 MHz) 26740 (819.00 MHz) 26783 (823.30 MHz)	1.4 MHz	QPSK / 16QAM	1 RB Half RB Full RB
	26705 (815.50 MHz) 26740 (819.00 MHz) 26775 (822.50 MHz)	3 MHz	QPSK / 16QAM	1 RB Half RB Full RB
	26715 (816.50 MHz) 26740 (819.00 MHz) 26765 (821.50 MHz)	5 MHz	QPSK / 16QAM	1 RB Half RB Full RB
	26740 (819.00 MHz)	10 MHz	QPSK / 16QAM	1 RB Half RB Full RB
Modulation Characteristics	26740 (819.00 MHz)	10MHz	QPSK / 16QAM	Full RB
Occupied Bandwidth	26697 (814.70 MHz) 26740 (819.00 MHz) 26783 (823.30 MHz)	1.4 MHz	QPSK / 16QAM	Full RB
	26705 (815.50 MHz) 26740 (819.00 MHz) 26775 (822.50 MHz)	3 MHz	QPSK / 16QAM	Full RB
	26715 (816.50 MHz) 26740 (819.00 MHz) 26765 (821.50 MHz)	5 MHz	QPSK / 16QAM	Full RB
	26740 (819.00 MHz)	10 MHz	QPSK / 16QAM	Full RB
Conducted Emission	26697 (814.70 MHz) 26740 (819.00 MHz) 26783 (823.30 MHz)	1.4 MHz	QPSK	1 RB Full RB
	26705 (815.50 MHz) 26740 (819.00 MHz) 26775 (822.50 MHz)	3 MHz	QPSK	1 RB Full RB
	26715 (816.50 MHz) 26740 (819.00 MHz) 26765 (821.50 MHz)	5 MHz	QPSK	1 RB Full RB
	26740 (819.00 MHz)	10 MHz	QPSK	1 RB Full RB
Radiated Spurious Emissions below 1GHz	26740 (819.00 MHz)	10 MHz	QPSK	1 RB
Radiated Spurious Emissions above 1GHz	26697 (814.70 MHz) 26740 (819.00 MHz) 26783 (823.30 MHz)	1.4 MHz	QPSK	1 RB
	26715 (816.50 MHz) 26740 (819.00 MHz) 26765 (821.50 MHz)	5 MHz	QPSK	1 RB
	26740 (819.00 MHz)	10 MHz	QPSK	1 RB
Frequency Stability	26697 (814.70 MHz) 26783 (823.30 MHz)	1.4 MHz	QPSK	Full RB
	26705 (815.50 MHz) 26775 (822.50 MHz)	3 MHz	QPSK	Full RB
	26715 (816.50 MHz) 26765 (821.50 MHz)	5 MHz	QPSK	Full RB
	26740 (819.00 MHz)	10 MHz	QPSK	Full RB

3.4 Test Program Used and Operation Descriptions

There is no need to controlling software during the test, and the EUT can be paired with the Radio Communication Analyzer to test the connection when it is powered on.

3.5 Connection Diagram of EUT and Peripheral Devices

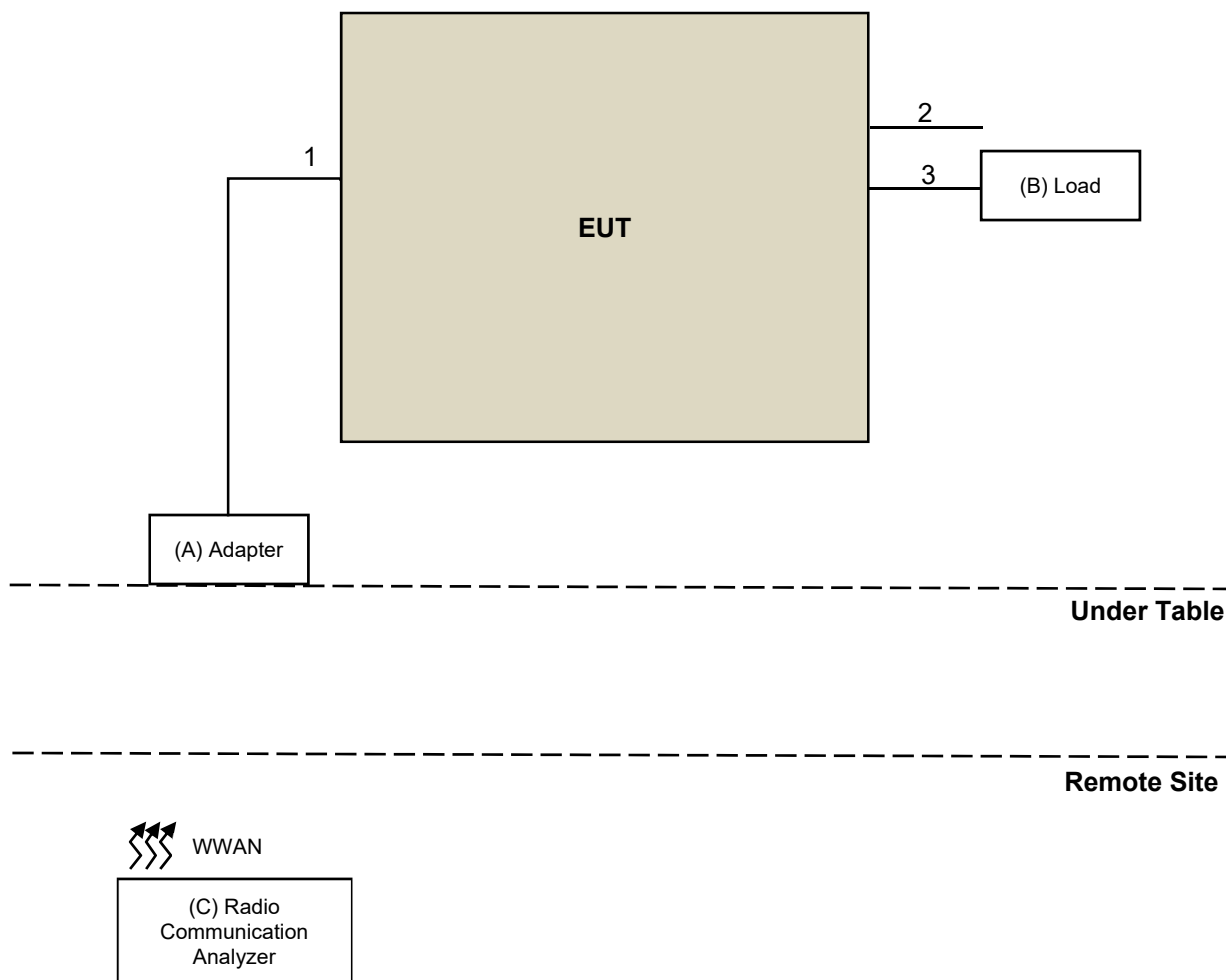

3.6 Configuration of Peripheral Devices and Cable Connections

ID	Product	Brand	Model No.	Serial No.	FCC ID	Remarks
A	Adapter	CUI INC	SWH15-5B-N	N/A	N/A	Accessory of EUT
B	Load	N/A	N/A	N/A	N/A	Provided by Lab
C	Radio Communication Analyzer	Anritsu	MT8821C	6201462755	N/A	Provided by Lab

ID	Cable Descriptions	Qty.	Length (m)	Shielding (Yes/No)	Cores (Qty.)	Remarks
1	DC Cable	1	1.8	No	0	Accessory of EUT
2	USB Cable	1	1	No	0	Provided by Lab
3	RJ-45 Cable	1	1.5	No	0	Provided by Lab

4 Test Instruments

The calibration interval of the all test instruments are 12 months and the calibrations are traceable to NML/ROC and NIST/USA.

4.1 Effective Radiated Power and Equivalent Isotropically Radiated Power

Description Manufacturer	Model No.	Serial No.	Calibrated Date	Calibrated Until
N9030B - PXA Signal Analyzer KEYSIGHT	N9030B	MY57140488	2023/3/6	2024/3/5
Radio Communication Analyzer Anritsu	MT8821C	6201462755	2023/3/3	2024/3/2
Software BV	ADT_RF Test Software V6.6.5.4	N/A	N/A	N/A

Notes:

1. The test was performed in Oven room.
2. Tested Date: 2023/10/25 ~ 2023/11/8

4.2 Modulation Characteristics

Description Manufacturer	Model No.	Serial No.	Calibrated Date	Calibrated Until
N9030B - PXA Signal Analyzer KEYSIGHT	N9030B	MY57140938	2023/3/16	2024/3/15
Radio Communication Analyzer Anritsu	MT8821C	6201462755	2023/3/3	2024/3/2
Software BV	ADT_RF Test Software V6.6.5.4	N/A	N/A	N/A

Notes:

1. The test was performed in Oven room.
2. Tested Date: 2023/8/31 ~ 2023/9/19

4.3 Peak to Average Ratio

Refer to section 4.2 to get information of the instruments.

4.4 Bandwidth

Refer to section 4.2 to get information of the instruments.

4.5 Conducted Spurious Emissions

Refer to section 4.2 to get information of the instruments.

4.6 Radiated Spurious Emissions below 1GHz

Description Manufacturer	Model No.	Serial No.	Calibrated Date	Calibrated Until
Software BV ADT	ADT_Radiated_ V7.6.15.9.5	NA	NA	NA
Antenna Tower Max-Full	MFT-151SS-0.5T	NA	NA	NA
Turn Table Max-Full	MF-7802BS	NA	NA	NA
Turn Table Controller Max-Full	MF-7802BS	MF780208674	NA	NA
EMI Test Receiver R&S	ESR3	102782	2022/12/12	2023/12/11
Signal & Spectrum Analyzer R&S	FSW43	101866	2023/1/10	2024/1/9
Loop Antenna TESEQ	HLA 6121	45745	2023/8/8	2024/8/7
Loop Antenna Electro-Metrics	EM-6879	269	2022/9/19 2023/9/23	2023/9/18 2023/9/22
Preamplifier EMCI	EMC001340	980201	2022/9/23 2023/9/27	2023/9/22 2024/9/26
RF Coaxial Cable EMCI	5D-NM-BM	140903+140902	2023/1/7	2024/1/6
Preamplifier EMCI	EMC330N	980782	2023/1/16	2024/1/15
Bi_Log Antenna Schwarzbeck	VULB 9168	9168-1213	2022/10/20 2023/10/13	2023/10/19 2024/10/12
RF Coaxial Cable EMCI	EMCCFD400-NM-NM-500	201233	2023/1/16	2024/1/15
RF Coaxial Cable EMCI	EMCCFD400-NM-NM- 3000	201235	2023/1/16	2024/1/15
RF Coaxial Cable EMCI	EMCCFD400-NM-NM- 9000	201236(with PAD)	2023/1/16	2024/1/15
Radio Communication Analyzer Anritsu	MT8821C	6201462755	2023/3/3	2024/3/2

Notes:

1. The test was performed in WM - 966 chamber 8.
2. Tested Date: 2023/9/15 ~ 2023/11/3

4.7 Radiated Spurious Emissions above 1GHz

Description Manufacturer	Model No.	Serial No.	Calibrated Date	Calibrated Until
Software BV ADT	ADT_Radiated_ V7.6.15.9.5	NA	NA	NA
Antenna Tower Max-Full	MFT-151SS-0.5T	NA	NA	NA
Turn Table Max-Full	MF-7802BS	NA	NA	NA
Turn Table Controller Max-Full	MF-7802BS	MF780208674	NA	NA
EMI Test Receiver R&S	ESR3	102782	2022/12/12	2023/12/11
Signal & Spectrum Analyzer R&S	FSW43	101866	2023/1/10	2024/1/9
Horn Antenna RFSPIN	DRH18-E	210103A18E	2022/11/13	2023/11/12
Preamplifier EMCI	EMC118A45SE	980808	2022/12/29	2023/12/28
RF Coaxial Cable EMCI	EMC104-SM-SM-1000	210102	2023/1/16	2024/1/15
RF Coaxial Cable EMCI	EMC104-SM-SM-3000	201231	2023/1/16	2024/1/15
RF Coaxial Cable EMCI	EMC104-SM-SM-9000	201243	2023/1/16	2024/1/15
Preamplifier EMCI	EMC184045SE	980788	2023/1/16	2024/1/15
Horn Antenna Schwarzbeck	BBHA 9170	9170-1049	2022/11/13	2023/11/12
RF Coaxial Cable EMCI	EMC101G-KM-KM-5000	201260	2023/1/16	2024/1/15
RF Coaxial Cable EMCI	EMC101G-KM-KM-3000	201257	2023/1/16	2024/1/15
RF Coaxial Cable EMCI	EMC101G-KM-KM-2000	201254	2023/1/16	2024/1/15
Radio Communication Analyzer Anritsu	MT8821C	6201462755	2023/3/3	2024/3/2

Notes:

1. The test was performed in WM - 966 chamber 8.
2. Tested Date: 2023/9/15 ~ 2023/11/3

4.8 Frequency Stability

Description Manufacturer	Model No.	Serial No.	Calibrated Date	Calibrated Until
3-channel DC power supply JIN YIH Technology	ODP3033	ODP30332128138	N/A	N/A
Digital Multimeter Fluke	87-III	70360742	2023/7/6	2024/7/5
Software BV	ADT_RF Test Software V6.6.5.4	N/A	N/A	N/A
Spectrum Analyzer R&S	FSV40	100980	2023/5/3	2024/5/2
Temperature & Humidity Chamber TERCHY	HRM-120RF	931022	2022/12/27	2023/12/26
Radio Communication Analyzer Anritsu	MT8821C	6201462755	2023/3/3	2024/3/2

Notes:

1. The test was performed in Oven room.
2. Tested Date: 2023/10/25

5 Limits of Test Items

5.1 Effective Radiated Power and Equivalent Isotropically Radiated Power

For WCDMA Band 2, LTE Band 2, LTE Band 25:

Mobile and portable stations are limited to 2 watts EIRP.

For WCDMA Band 4, LTE Band 4:

Fixed, mobile, and portable (hand-held) stations operating in the 1710-1755 MHz band and mobile and portable stations operating in the 1695-1710 MHz and 1755-1780 MHz bands are limited to 1 watt EIRP.

For WCDMA Band 5, LTE Band 5, LTE Band 26(824 MHz ~ 849 MHz):

The ERP of mobile transmitters and auxiliary test transmitters must not exceed 7 watts.

For LTE Band 26(814 MHz ~ 824 MHz):

The output power shall be according to the specific rule Part 90.635 that "Mobile station are limited to 100 watts e.r.p".

For LTE Band 12:

Portable stations (hand-held devices) in the 600 MHz uplink band and the 698-746 MHz band, and fixed and mobile stations in the 600 MHz uplink band are limited to 3 watts ERP.

5.2 Modulation Characteristics

A curve or equivalent data which shows that the equipment will meet the modulation requirements of the rules under which the equipment is to be licensed.

5.3 Peak to Average Ratio

In measuring transmissions in this band using an average power technique, the peak to-average ratio (PAR) of the transmission may not exceed 13 dB.

5.4 Bandwidth

According to FCC 47 CFR part 2.1049, the occupied bandwidth, that is the frequency bandwidth such that, below its lower and above its upper frequency limits, the mean powers radiated are each equal to 0.5% of the total mean power radiated by a given emission.

5.5 Conducted Spurious Emissions

For WCDMA Band 2, WCDMA Band 5, LTE Band 2, LTE Band 5, LTE Band 25, LTE Band 26(824 MHz ~ 849 MHz):

The power of any emission outside of the authorized operating frequency ranges must be attenuated below the transmitting power (P) by a factor of at least $43 + 10 \log(P)$ dB. The emission limit equal to -13 dBm.

For WCDMA Band 4, LTE Band 4:

According to FCC 47 CFR part 27.53(h), for operations in the 1695-1710 MHz, 1710-1755 MHz, 1755-1780 MHz, 1915-1920 MHz, 1995-2000 MHz, 2000-2020 MHz, 2110-2155 MHz, 2155-2180 MHz, and 2180-2200 MHz bands, the power of any emission outside a licensee's frequency block shall be attenuated below the transmitter power (P) in watts by at least $43 + 10 \log(P)$ dB. However, in the 1 megahertz bands immediately outside and adjacent to the licensee's frequency block, a resolution bandwidth of at least one percent of the emission bandwidth of the fundamental emission of the transmitter may be employed.

For LTE Band 12:

According to FCC 47 CFR part 27.53(g), for operations in the 600 MHz band and the 698-746 MHz band, the power of any emission outside a licensee's frequency band(s) of operation shall be attenuated below the transmitter power (P) within the licensed band(s) of operation, measured in watts, by at least $43 + 10 \log(P)$ dB. Compliance with this provision is based on the use of measurement instrumentation employing a resolution bandwidth of 100 kilohertz or greater. However, in the 100 kilohertz bands immediately outside and adjacent to a licensee's frequency block, a resolution bandwidth of at least 30 kHz may be employed.

For LTE Band 26(814 MHz ~ 824 MHz):

According to FCC part 90.691 shall be tested the emission mask. For any frequency removed from the EA licensee's frequency block by up to and including 37.5 kHz, the power of any emission shall be attenuated below the transmitter power (P) in watts by at least $116 \log_{10}(f/6.1)$ decibels or $50 + 10 \log_{10}(P)$ decibels or 80 decibels, whichever is the lesser attenuation, where f is the frequency removed from the center of the outer channel in the block in kilohertz and where f is greater than 12.5 kHz.

For any frequency removed from the EA licensee's frequency block greater than 37.5 kHz, the power of any emission shall be attenuated below the transmitter power (P) in watts by at least $43 + 10 \log_{10}(P)$ decibels or 80 decibels, whichever is the lesser attenuation, where f is the frequency removed from the center of the outer channel in the block in kilohertz and where f is greater than 37.5 kHz.

For § 90.691(a), RBW=300 Hz for offset less than 37.5 kHz from channel edge and RBW=100 kHz for offsets greater than 37.5 kHz is allowed, tested in accordance with FCC KDB 971168 D02 section VIII.

5.6 Radiated Spurious Emissions below 1GHz

For WCDMA Band 2, WCDMA Band 5, LTE Band 2, LTE Band 5, LTE Band 25, LTE Band 26:

The power of any emission outside of the authorized operating frequency ranges must be attenuated below the transmitting power (P) by a factor of at least $43 + 10 \log(P)$ dB. The emission limit equal to -13 dBm.

For WCDMA Band 4, LTE Band 4:

According to FCC 47 CFR part 27.53(h), for operations in the 1695-1710 MHz, 1710-1755 MHz, 1755-1780 MHz bands, the power of any emission outside a licensee's frequency block shall be attenuated below the transmitter power (P) in watts by at least $43 + 10 \log(P)$ dB. The limit of emission is equal to -13 dBm.

For LTE Band 12:

According to FCC 47 CFR part 27.53(g), for operations in the 600 MHz band and the 698-746 MHz band, the power of any emission outside a licensee's frequency band(s) of operation shall be attenuated below the transmitter power (P) within the licensed band(s) of operation, measured in watts, by at least $43 + 10 \log(P)$ dB. The limit of emissions is equal to -13 dBm.

5.7 Radiated Spurious Emissions above 1GHz

For WCDMA Band 2, WCDMA Band 5, LTE Band 2, LTE Band 5, LTE Band 25, LTE Band 26:

The power of any emission outside of the authorized operating frequency ranges must be attenuated below the transmitting power (P) by a factor of at least $43 + 10 \log(P)$ dB. The emission limit equal to -13 dBm.

For WCDMA Band 4, LTE Band 4:

According to FCC 47 CFR part 27.53(h), for operations in the 1695-1710 MHz, 1710-1755 MHz, 1755-1780 MHz bands, the power of any emission outside a licensee's frequency block shall be attenuated below the transmitter power (P) in watts by at least $43 + 10 \log(P)$ dB. The limit of emission is equal to -13 dBm.

For LTE Band 12:

According to FCC 47 CFR part 27.53(g), for operations in the 600 MHz band and the 698-746 MHz band, the power of any emission outside a licensee's frequency band(s) of operation shall be attenuated below the transmitter power (P) within the licensed band(s) of operation, measured in watts, by at least $43 + 10 \log(P)$ dB. The limit of emissions is equal to -13 dBm.

5.8 Frequency Stability

For WCDMA Band 5, LTE Band 5, LTE Band 26:

1.5 ppm is for base and fixed station. 2.5 ppm is for mobile station.

For WCDMA Band 2, WCDMA Band 4, LTE Band 2, LTE Band 4, LTE Band 12, LTE Band 25:

The frequency stability shall be sufficient to ensure that the fundamental emissions stay within the authorized bands of operation (authorized frequency block).

6 Test Arrangements

6.1 Effective Radiated Power and Equivalent Isotropically Radiated Power

6.1.1 Test Setup

Conducted Power Measurement:

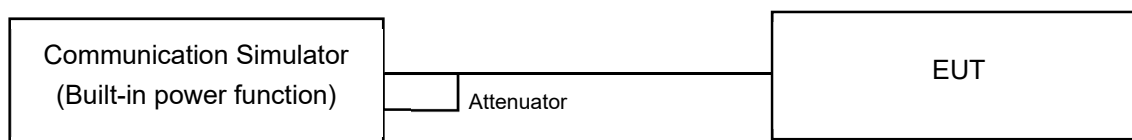

6.1.2 Test Procedure

Conducted Power Measurement:

The EUT is configured by emulator to set data modulation and maximum power using WWAN technology and link to Simulator. Set the EUT to transmit under low, middle and high channel and record the power level shown on Simulator. Power measurements use detector average (rms).

Maximum EIRP / ERP

The relevant equation for determining the maximum ERP or EIRP from the measured RF output power is given in Equation as follows:

$$\text{EIRP} = P_{\text{Meas}} + G_{\text{T}}$$

$$\text{ERP} = P_{\text{Meas}} + G_{\text{T}} - 2.15$$

where

ERP or EIRP effective radiated power or equivalent isotropically radiated power, respectively

(expressed in the same units as P_{Meas} , e.g., dBm or dBW)

P_{Meas} measured transmitter output power or PSD, in dBm or dBW

G_{T} gain of the transmitting antenna, in dBd (ERP) or dBi (EIRP)

6.2 Modulation Characteristics

6.2.1 Test Setup

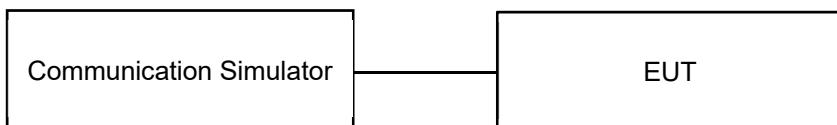

6.2.2 Test Procedure

Connect the EUT to Communication Simulator via the antenna connector, the frequency band is set as EUT supported Modulation and Channels, the EUT output is matched with 50 ohm load, the waveform quality and constellation of the EUT was tested.

6.3 Peak to Average Ratio

6.3.1 Test Setup

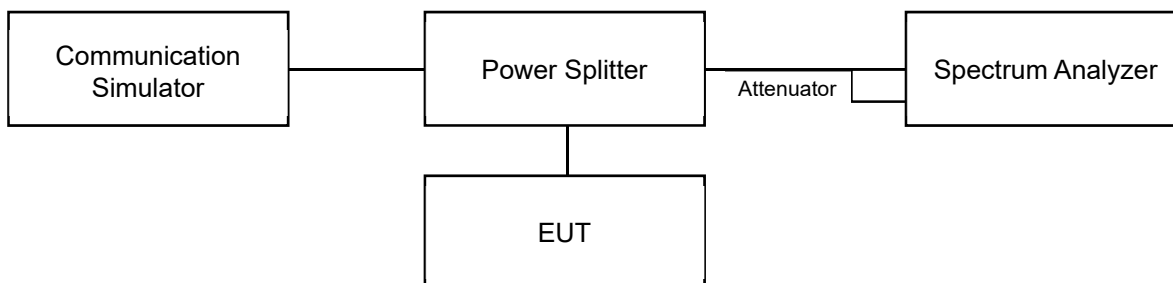

6.3.2 Test Procedure

- a. Set resolution/measurement bandwidth \geq signal's occupied bandwidth;
- b. Set the number of counts to a value that stabilizes the measured CCDF curve;
- c. Record the maximum PAPR level associated with a probability of 0.1%.

6.4 Bandwidth

6.4.1 Test Setup

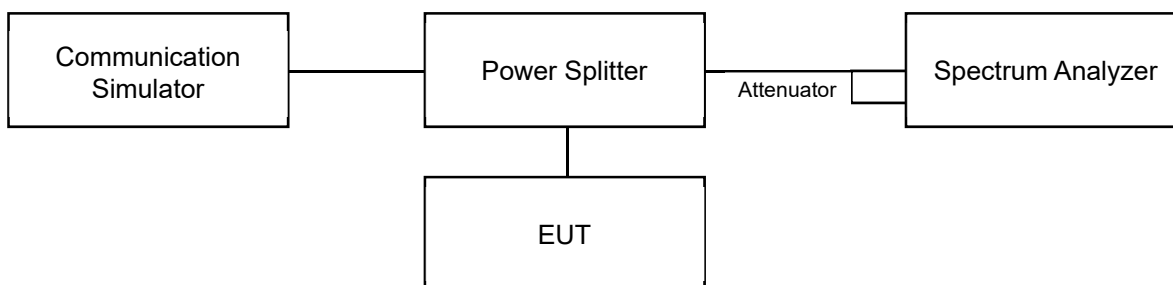

6.4.2 Test Procedure

For the 26 dBc bandwidth measurement method, please refer to section 5.4.3 of ANSI C63.26.

- a. The spectrum analyzer center frequency is set to the nominal EUT channel center frequency. The span range for the spectrum analyzer shall be wide enough to see sufficient roll off of the signal to make the measurement.
- b. The nominal RBW shall be in the range of 1% to 5% of the anticipated OBW, and the VBW shall be set $\geq 3 \times$ RBW.
- c. Set the reference level of the instrument as required to prevent the signal amplitude from exceeding the maximum spectrum analyzer input mixer level for linear operation. See guidance provided in 4.2.3.
- d. The dynamic range of the spectrum analyzer at the selected RBW shall be more than 10 dB below the target “-X dB” requirement, i.e., if the requirement calls for measuring the -26 dB OBW, the spectrum analyzer noise floor at the selected RBW shall be at least 36 dB below the reference level.
- e. Set spectrum analyzer detection mode to peak, and the trace mode to max hold.
- f. Determine the following reference values: Set the EUT to transmit a modulated signal. Allow the trace to stabilize. Set the spectrum analyzer marker to the highest level of the displayed trace (this is the reference value).
- g. Determine the “-X dB amplitude” as equal to (Reference Value - X). Alternatively, this calculation can be performed on the spectrum analyzer using the delta-marker measurement function.
- h. Place two markers, one at the lowest and the other at the highest frequency of the envelope of the spectral display such that each marker is at or slightly below the “-X dB amplitude” determined in step f). If a marker is below this “-X dB amplitude” value it should be as close as possible to this value. The OBW is the positive frequency difference between the two markers.
- i. The OBW shall be reported by providing plot(s) of the measuring instrument display, to include markers depicting the relevant frequency and amplitude information (e.g., marker table). The frequency and amplitude axis and scale shall be clearly labeled. Tabular data may be reported in addition to the plot(s).

For the occupied bandwidth measurement method, please refer to section 5.4.4 of ANSI C63.26.

- a. The spectrum analyzer center frequency is set to the nominal EUT channel center frequency. The span range for the spectrum analyzer shall be wide enough to see sufficient roll off of the signal to make the measurement.
- b. The nominal RBW shall be in the range of 1% to 5% of the anticipated OBW, and the VBW shall be set $\geq 3 \times$ RBW.
- c. Set the reference level of the instrument as required to prevent the signal amplitude from exceeding the maximum spectrum analyzer input mixer level for linear operation. See guidance provided in 4.2.3.
- d. The dynamic range of the spectrum analyzer at the selected RBW shall be more than 10 dB below the target “-X dB” requirement, i.e., if the requirement calls for measuring the -26 dB OBW, the spectrum analyzer noise floor at the selected RBW shall be at least 36 dB below the reference level.
- e. Set spectrum analyzer detection mode to peak, and the trace mode to max hold.
- f. Determine the reference value by either of the following:
 - g. 1) Set the EUT to transmit a modulated signal. Allow the trace to stabilize. Set the spectrum analyzer marker to the highest level of the displayed trace (this is the reference value).
 - h. 2) Set the EUT to transmit an unmodulated carrier. Set the spectrum analyzer marker to the level of the carrier.
- i. Determine the “-X dB amplitude” as equal to (Reference Value - X). Alternatively, this calculation can be performed on the spectrum analyzer using the delta-marker measurement function.
- j. If the reference value was determined using an unmodulated carrier, turn the EUT modulation on, then either clear the existing trace or start a new trace on the spectrum analyzer and allow the new trace to stabilize. Otherwise the trace from step f) shall be used for step i).
- k. Place two markers, one at the lowest and the other at the highest frequency of the envelope of the spectral display such that each marker is at or slightly below the “-X dB amplitude” determined in step f). If a marker is below this “-X dB amplitude” value it should be as close as possible to this value. The OBW is the positive frequency difference between the two markers. The spectral envelope can cross the “-X dB amplitude” at multiple points. The lowest or highest frequency shall be selected as the frequencies that are the farthest away from the center frequency at which the spectral envelope crosses the “-X dB amplitude.”
- l. The OBW shall be reported by providing plot(s) of the measuring instrument display, to include markers depicting the relevant frequency and amplitude information (e.g., marker table). The frequency and amplitude axis and scale shall be clearly labeled. Tabular data may be reported in addition to the plot(s).

6.5 Conducted Spurious Emissions

6.5.1 Test Setup

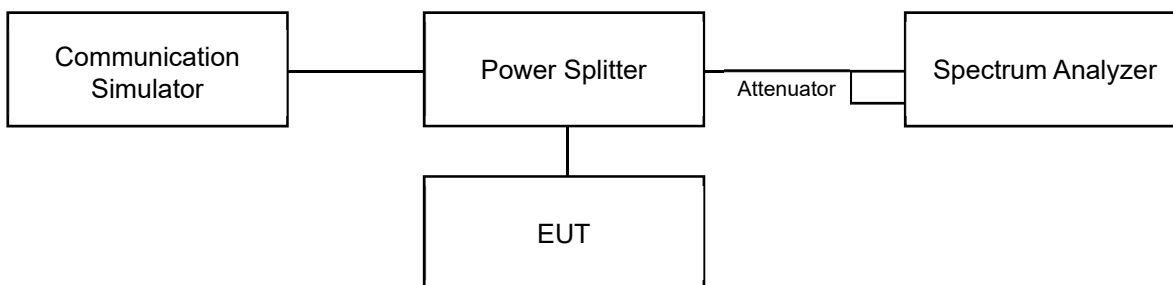

6.5.2 Test Procedure

- a. Measurement refer to ANSI C63.26 section 5.7.
- b. All measurements were done at 3 channels: low, middle and high operational frequency range.
- c. Measuring frequency range is from 9 kHz up to the tenth harmonic of the highest fundamental frequency or to 40 GHz, whichever is lower. 20 dB attenuation pad is connected with spectrum.
- d. The fundamental frequency above 1 GHz, the spectrum set RBW = 1 MHz, VBW = 3 MHz, Detector = Average.
- e. The fundamental frequency below 1 GHz, the spectrum set RBW \geq 100 kHz, VBW \geq 3 x RBW, Detector = Average.
- f. Measuring frequency band edge, narrow RBW (no less than 1% of the OBW) is used for conducted emission measurement.

6.6 Radiated Spurious Emissions below 1GHz

6.6.1 Test Setup

For radiated emission 30 MHz to 1 GHz

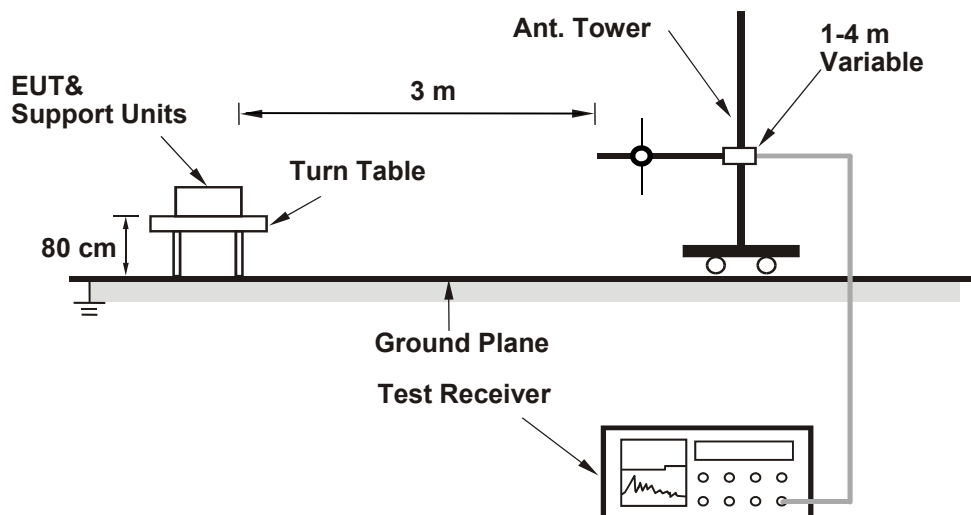

For the actual test configuration, please refer to the attached file (Test Setup Photo).

6.6.2 Test Procedure

The EUT is configured by emulator to set data modulation and maximum power using WWAN technology.

- In the semi-anechoic chamber, EUT placed on the 0.8 m (below or equal 1 GHz) height of turn table, rotated the table around 360 degrees to search the maximum radiation power and receiver antenna shall be rotated vertical and horizontal polarization and moved height from 1 m to 4 m to find the maximum polar radiated power. The "Read Value" is the spectrum reading the maximum power value.
- The height of antenna is varied from one meter to four meters above the ground to determine the maximum value of the field strength. Both horizontal and vertical polarizations of the antenna are set to make the measurement.
- Perform a field strength measurement and record the worse read value, is the field strength value via a spectrum reading obtained corrected for antenna factor, cable loss and pre-amplifier factor and then mathematically convert the measured field strength level to EIRP/ERP level.
- Following C63.26 section 5.5 and 5.2.7
- $EIRP (dBm) = E (dB\mu V/m) + 20\log(D) - 104.8$; where D is the measurement distance (in the far field region) in m.
- $ERP (dBm) = E (dB\mu V/m) + 20\log(D) - 104.8 - 2.15$; where D is the measurement distance (in the far field region) in m.

Note:

- The resolution bandwidth and video bandwidth of test receiver/spectrum analyzer is 1 MHz/3 MHz.
- The emission levels were against the limit of frequency range 9 kHz ~ 30 MHz:
The amplitude of spurious emissions attenuated more than 20 dB below the permissible value is not required to be report.

6.7 Radiated Spurious Emissions above 1GHz

6.7.1 Test Setup

For radiated emission above 1 GHz

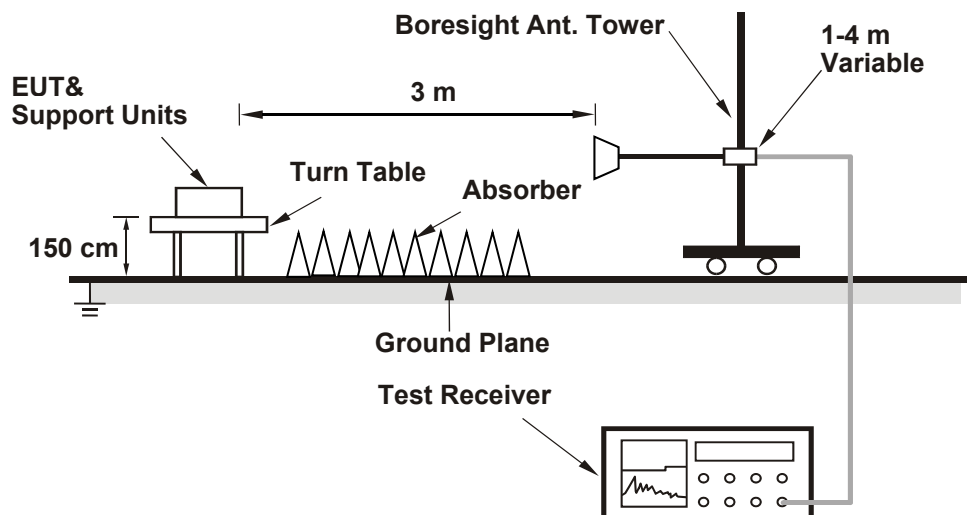

For the actual test configuration, please refer to the attached file (Test Setup Photo).

6.7.2 Test Procedure

The EUT is configured by emulator to set data modulation and maximum power using WWAN technology.

- In the semi-anechoic chamber, EUT placed on the 1.5 m height of turn table, rotated the table around 360 degrees to search the maximum radiation power and receiver antenna shall be rotated vertical and horizontal polarization and moved height from 1 m to 4 m to find the maximum polar radiated power. The "Read Value" is the spectrum reading the maximum power value.
- The height of antenna is varied from one meter to four meters above the ground to determine the maximum value of the field strength. Both horizontal and vertical polarizations of the antenna are set to make the measurement.
- Perform a field strength measurement and record the worse read value, is the field strength value via a spectrum reading obtained corrected for antenna factor, cable loss and pre-amplifier factor and then mathematically convert the measured field strength level to EIRP/ERP level.
- Following C63.26 section 5.5 and 5.2.7
- $EIRP (dBm) = E (dB\mu V/m) + 20\log(D) - 104.8$; where D is the measurement distance (in the far field region) in m.
- $ERP (dBm) = E (dB\mu V/m) + 20\log(D) - 104.8 - 2.15$; where D is the measurement distance (in the far field region) in m.

Note:

- The resolution bandwidth and video bandwidth of test receiver/spectrum analyzer is 1 MHz/3 MHz.

6.8 Frequency Stability

6.8.1 Test Setup

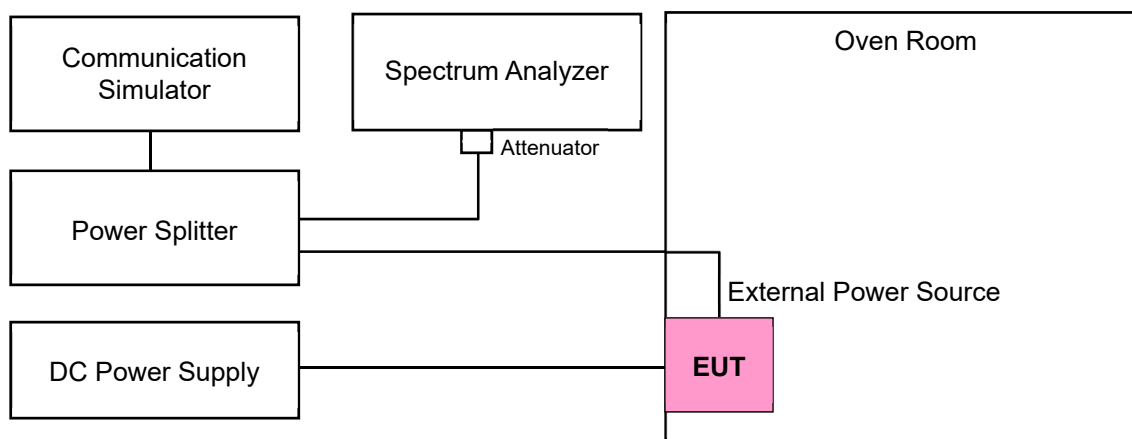

6.8.2 Test Procedure

The EUT is configured by emulator to set data modulation and maximum power using WWAN technology.

- Device is placed at the oven room. The oven room could control the temperatures and humidity. Power warm up is at least 15 min and power applied should perform before recording frequency error.
- EUT is connected the external power supply to control the DC input power. The test voltage range is from minimum to maximum working voltage. Each step shall be record the frequency error rate.
- The temperature range step is 10 degrees in this test items. All temperature levels shall be hold the $\pm 0.5^{\circ}\text{C}$ during the measurement testing. The each temperature step shall be at least 0.5 hours, consider the EUT could be test under the stability condition.

Note: The frequency error was recorded frequency error from the communication simulator.

7 Test Results of Test Item

7.1 Effective Radiated Power and Equivalent Isotropically Radiated Power

Input Power:	3.6 Vdc	Environmental Conditions:	21°C, 70% RH	Tested By:	Willy Cheng
--------------	---------	---------------------------	--------------	------------	-------------

7.1.1 WCDMA Band 2

Conducted Output Power (dBm)

Band	WCDMA II		
TX Channel	9262	9400	9538
Rx Channel	9662	9800	9938
Frequency	1852.4	1880	1907.6
RMC 12.2K	22.06	22.14	22.07
HSDPA	22.01	22.04	22.02
HSUPA	21.73	21.75	22.00

EIRP Power (dBm)

Band	WCDMA II		
TX Channel	9262	9400	9538
Rx Channel	9662	9800	9938
Frequency	1852.4	1880	1907.6
RMC 12.2K	25.44	25.52	25.45
HSDPA	25.39	25.42	25.40
HSUPA	25.11	25.13	25.38

*EIRP (dBm) = Conducted Output Power (dBm) + Antenna Gain (dBi)

7.1.2 WCDMA Band 4

Conducted Output Power (dBm)

Band	WCDMA IV		
TX Channel	1312	1413	1513
Rx Channel	1537	1638	1738
Frequency	1712.4	1732.6	1752.6
RMC 12.2K	22.63	22.75	22.59
HSDPA	22.47	22.51	22.36
HSUPA	22.31	22.19	22.14

EIRP Power (dBm)

Band	WCDMA IV		
TX Channel	1312	1413	1513
Rx Channel	1537	1638	1738
Frequency	1712.4	1732.6	1752.6
RMC 12.2K	26.50	26.62	26.46
HSDPA	26.34	26.38	26.23
HSUPA	26.18	26.06	26.01

*EIRP (dBm) = Conducted Output Power (dBm) + Antenna Gain (dBi)

7.1.3 WCDMA Band 5

Conducted Output Power (dBm)

Band	WCDMA V		
TX Channel	4132	4182	4233
Rx Channel	4357	4407	4458
Frequency	826.4	836.4	846.6
RMC 12.2K	23.60	23.71	23.64
HSDPA	23.48	23.57	23.41
HSUPA	22.87	23.02	22.96

ERP Power (dBm)

Band	WCDMA V		
TX Channel	4132	4182	4233
Rx Channel	4357	4407	4458
Frequency	826.4	836.4	846.6
RMC 12.2K	18.23	18.34	18.27
HSDPA	18.11	18.20	18.04
HSUPA	17.50	17.65	17.59

*ERP (dBm) = Conducted Output Power (dBm) + Antenna Gain (dBi) - 2.15

7.1.4 LTE Band 2

Conducted Output Power (dBm)

BW	MCS Index	RB Size	RB Offset	Low	Mid	High
		Channel		18700	18900	19100
		Frequency (MHz)		1860	1880	1900
20M	QPSK	1	0	22.35	22.48	22.22
		1	50	22.16	22.09	22.15
		1	99	22.24	21.86	21.89
		50	0	21.20	21.22	21.31
		50	25	21.19	21.21	21.34
		50	50	21.18	21.16	21.30
		100	0	21.14	21.19	21.23
20M	16QAM	1	0	21.25	21.32	22.18
		1	50	20.95	21.09	22.10
		1	99	21.24	20.67	21.27
		25	0	20.12	20.26	20.35
		25	12	20.17	20.24	20.29
		25	25	20.19	20.15	20.24
		100	0	-	-	-

BW	MCS Index	RB Size	RB Offset	Low	Mid	High
		Channel		18675	18900	19125
		Frequency (MHz)		1857.5	1880	1902.5
15M	QPSK	1	0	21.99	22.15	22.22
		1	37	22.39	22.12	22.27
		1	74	22.28	21.97	22.18
		36	0	21.16	21.23	21.28
		36	19	21.28	21.10	21.23
		36	39	21.13	21.04	21.14
		75	0	21.15	21.11	21.08
15M	16QAM	1	0	21.29	21.27	20.96
		1	37	20.95	21.38	21.11
		1	74	20.82	21.49	20.78
		25	0	20.20	20.26	20.32
		25	12	20.22	20.32	20.54
		25	25	20.00	20.28	20.31
		75	0	-	-	-

BW	MCS Index	RB Size	RB Offset	Low	Mid	High
		Channel		18650	18900	19150
		Frequency (MHz)		1855	1880	1905
10M	QPSK	1	0	22.07	21.98	22.13
		1	24	22.11	22.11	22.23
		1	49	21.76	21.80	21.97
		25	0	21.06	21.15	21.26
		25	12	21.20	21.24	21.22
		25	25	21.08	21.09	21.16
		50	0	21.13	21.22	21.32
10M	16QAM	1	0	21.21	21.02	21.87
		1	24	21.26	21.00	20.68
		1	49	20.87	21.13	20.83
		25	0	20.12	20.29	20.33
		25	12	20.39	20.20	20.34
		25	25	20.23	20.08	20.35
		50	0	-	-	-

BW	MCS Index	RB Size	RB Offset	Low	Mid	High
		Channel		18625	18900	19175
		Frequency (MHz)		1852.5	1880	1907.5
5M	QPSK	1	0	22.07	21.92	22.21
		1	12	21.95	22.04	22.18
		1	24	22.07	22.08	21.97
		12	0	21.02	21.23	21.22
		12	6	21.07	21.13	21.27
		12	13	21.19	21.08	21.13
		25	0	21.12	21.17	21.29
5M	16QAM	1	0	20.62	20.59	20.73
		1	12	21.09	21.11	20.68
		1	24	20.93	20.97	20.83
		12	0	20.15	20.05	20.32
		12	6	20.16	19.99	20.32
		12	13	20.18	19.93	20.13
		25	0	20.24	20.17	20.30

BW	MCS Index	RB Size	RB Offset	Low	Mid	High
		Channel		18615	18900	19185
		Frequency (MHz)		1851.5	1880	1908.5
3M	QPSK	1	0	22.24	22.06	22.41
		1	7	21.96	22.04	22.16
		1	14	22.01	21.97	22.17
		8	0	21.11	21.15	21.30
		8	3	21.16	21.17	21.26
		8	7	21.07	21.11	21.23
		15	0	21.13	21.14	21.32
3M	16QAM	1	0	21.27	20.84	20.83
		1	7	21.18	20.58	20.91
		1	14	21.26	20.89	20.96
		8	0	20.21	20.20	20.40
		8	3	20.23	20.06	20.21
		8	7	20.12	20.24	20.25
		15	0	19.94	20.26	20.20

BW	MCS Index	RB Size	RB Offset	Low	Mid	High
		Channel		18607	18900	19193
		Frequency (MHz)		1850.7	1880	1909.3
1.4M	QPSK	1	0	21.87	22.01	22.40
		1	2	22.11	22.19	22.29
		1	5	22.04	21.85	22.03
		3	0	22.16	22.18	22.27
		3	1	22.22	22.26	22.30
		3	3	22.13	22.13	22.14
		6	0	21.20	21.11	21.24
1.4M	16QAM	1	0	21.30	20.90	21.29
		1	2	20.91	21.23	20.91
		1	5	21.06	20.63	20.72
		3	0	21.14	21.10	21.29
		3	1	21.23	21.00	21.34
		3	3	21.10	21.09	21.46
		6	0	20.02	20.11	20.24

EIRP Power (dBm)

BW	MCS Index	RB Size	RB Offset	Low	Mid	High
		Channel		18700	18900	19100
		Frequency (MHz)		1860	1880	1900
20M	QPSK	1	0	25.73	25.86	25.60
		1	50	25.54	25.47	25.53
		1	99	25.62	25.24	25.27
		50	0	24.58	24.60	24.69
		50	25	24.57	24.59	24.72
		50	50	24.56	24.54	24.68
		100	0	24.52	24.57	24.61
20M	16QAM	1	0	24.63	24.70	25.56
		1	50	24.33	24.47	25.48
		1	99	24.62	24.05	24.65
		25	0	23.50	23.64	23.73
		25	12	23.55	23.62	23.67
		25	25	23.57	23.53	23.62
		100	0	-	-	-

*EIRP (dBm) = Conducted Output Power (dBm) + Antenna Gain (dBi)

BW	MCS Index	RB Size	RB Offset	Low	Mid	High
		Channel		18675	18900	19125
		Frequency (MHz)		1857.5	1880	1902.5
15M	QPSK	1	0	25.37	25.53	25.60
		1	37	25.77	25.50	25.65
		1	74	25.66	25.35	25.56
		36	0	24.54	24.61	24.66
		36	19	24.66	24.48	24.61
		36	39	24.51	24.42	24.52
		75	0	24.53	24.49	24.46
15M	16QAM	1	0	24.67	24.65	24.34
		1	37	24.33	24.76	24.49
		1	74	24.20	24.87	24.16
		25	0	23.58	23.64	23.70
		25	12	23.60	23.70	23.92
		25	25	23.38	23.66	23.69
		75	0	-	-	-

*EIRP (dBm) = Conducted Output Power (dBm) + Antenna Gain (dBi)

BW	MCS Index	RB Size	RB Offset	Low	Mid	High
		Channel		18650	18900	19150
		Frequency (MHz)		1855	1880	1905
10M	QPSK	1	0	25.45	25.36	25.51
		1	24	25.49	25.49	25.61
		1	49	25.14	25.18	25.35
		25	0	24.44	24.53	24.64
		25	12	24.58	24.62	24.60
		25	25	24.46	24.47	24.54
		50	0	24.51	24.60	24.70
10M	16QAM	1	0	24.59	24.40	25.25
		1	24	24.64	24.38	24.06
		1	49	24.25	24.51	24.21
		25	0	23.50	23.67	23.71
		25	12	23.77	23.58	23.72
		25	25	23.61	23.46	23.73
		50	0	-	-	-

*EIRP (dBm) = Conducted Output Power (dBm) + Antenna Gain (dBi)

BW	MCS Index	RB Size	RB Offset	Low	Mid	High
		Channel		18625	18900	19175
		Frequency (MHz)		1852.5	1880	1907.5
5M	QPSK	1	0	25.45	25.30	25.59
		1	12	25.33	25.42	25.56
		1	24	25.45	25.46	25.35
		12	0	24.40	24.61	24.60
		12	6	24.45	24.51	24.65
		12	13	24.57	24.46	24.51
		25	0	24.50	24.55	24.67
5M	16QAM	1	0	24.00	23.97	24.11
		1	12	24.47	24.49	24.06
		1	24	24.31	24.35	24.21
		12	0	23.53	23.43	23.70
		12	6	23.54	23.37	23.70
		12	13	23.56	23.31	23.51
		25	0	23.62	23.55	23.68

*EIRP (dBm) = Conducted Output Power (dBm) + Antenna Gain (dBi)

BW	MCS Index	RB Size	RB Offset	Low	Mid	High
		Channel		18615	18900	19185
		Frequency (MHz)		1851.5	1880	1908.5
3M	QPSK	1	0	25.62	25.44	25.79
		1	7	25.34	25.42	25.54
		1	14	25.39	25.35	25.55
		8	0	24.49	24.53	24.68
		8	3	24.54	24.55	24.64
		8	7	24.45	24.49	24.61
		15	0	24.51	24.52	24.70
3M	16QAM	1	0	24.65	24.22	24.21
		1	7	24.56	23.96	24.29
		1	14	24.64	24.27	24.34
		8	0	23.59	23.58	23.78
		8	3	23.61	23.44	23.59
		8	7	23.50	23.62	23.63
		15	0	23.32	23.64	23.58

*EIRP (dBm) = Conducted Output Power (dBm) + Antenna Gain (dBi)

BW	MCS Index	RB Size	RB Offset	Low	Mid	High
		Channel		18607	18900	19193
		Frequency (MHz)		1850.7	1880	1909.3
1.4M	QPSK	1	0	25.25	25.39	25.78
		1	2	25.49	25.57	25.67
		1	5	25.42	25.23	25.41
		3	0	25.54	25.56	25.65
		3	1	25.60	25.64	25.68
		3	3	25.51	25.51	25.52
		6	0	24.58	24.49	24.62
1.4M	16QAM	1	0	24.68	24.28	24.67
		1	2	24.29	24.61	24.29
		1	5	24.44	24.01	24.10
		3	0	24.52	24.48	24.67
		3	1	24.61	24.38	24.72
		3	3	24.48	24.47	24.84
		6	0	23.40	23.49	23.62

*EIRP (dBm) = Conducted Output Power (dBm) + Antenna Gain (dBi)

7.1.5 LTE Band 4

Conducted Output Power (dBm)

BW	MCS Index	RB Size	RB Offset	Low	Mid	High
		Channel		20050	20175	20300
		Frequency (MHz)		1720	1732.5	1745
20M	QPSK	1	0	22.23	22.61	22.42
		1	50	22.44	22.30	22.50
		1	99	22.31	22.02	22.22
		50	0	21.35	21.51	21.53
		50	25	21.46	21.52	21.46
		50	50	21.42	21.34	21.32
		100	0	21.36	21.35	21.40
20M	16QAM	1	0	21.45	21.47	21.71
		1	50	21.65	21.24	21.18
		1	99	20.81	21.39	20.94
		25	0	20.24	20.55	20.56
		25	12	20.41	20.44	20.64
		25	25	20.37	20.59	20.45
		100	0	-	-	-

BW	MCS Index	RB Size	RB Offset	Low	Mid	High
		Channel		20025	20175	20325
		Frequency (MHz)		1717.5	1732.5	1747.5
15M	QPSK	1	0	22.47	22.17	22.45
		1	37	22.49	22.23	22.52
		1	74	22.37	21.95	22.11
		36	0	21.27	21.45	21.48
		36	19	21.19	21.30	21.33
		36	39	21.36	21.31	21.29
		75	0	21.28	21.35	21.26
15M	16QAM	1	0	21.17	20.94	21.59
		1	37	20.94	21.18	20.71
		1	74	21.50	20.64	21.06
		25	0	20.30	20.39	20.40
		25	12	20.26	20.40	20.37
		25	25	20.32	20.40	20.33
		75	0	-	-	-

BW	MCS Index	RB Size	RB Offset	Low	Mid	High
		Channel		20000	20175	20350
		Frequency (MHz)		1715	1732.5	1750
10M	QPSK	1	0	22.31	22.09	22.27
		1	24	22.01	21.97	21.93
		1	49	22.14	22.09	22.03
		25	0	21.20	21.35	21.26
		25	12	21.32	21.29	21.25
		25	25	21.27	21.29	21.28
		50	0	21.25	21.26	21.22
10M	16QAM	1	0	21.18	21.42	21.69
		1	24	20.69	21.34	21.23
		1	49	20.78	20.57	20.98
		25	0	20.27	20.43	20.29
		25	12	20.34	20.34	20.34
		25	25	20.34	20.32	20.53
		50	0	-	-	-

BW	MCS Index	RB Size	RB Offset	Low	Mid	High
		Channel		19975	20175	20375
		Frequency (MHz)		1712.5	1732.5	1752.5
5M	QPSK	1	0	22.16	22.11	22.13
		1	12	22.21	22.17	22.24
		1	24	21.84	21.89	22.02
		12	0	21.09	21.26	21.17
		12	6	21.25	21.23	21.23
		12	13	21.25	21.29	21.28
		25	0	21.28	21.33	21.16
5M	16QAM	1	0	20.78	20.83	21.02
		1	12	21.34	21.29	20.56
		1	24	20.99	20.97	21.29
		12	0	20.02	20.32	20.08
		12	6	20.45	20.20	20.21
		12	13	20.21	20.17	20.27
		25	0	20.21	20.22	20.28

BW	MCS Index	RB Size	RB Offset	Low	Mid	High
		Channel		19965	20175	20385
		Frequency (MHz)		1711.5	1732.5	1753.5
3M	QPSK	1	0	22.35	22.37	22.03
		1	7	22.23	22.23	22.10
		1	14	22.02	22.10	21.85
		8	0	21.33	21.32	21.08
		8	3	21.19	21.23	21.16
		8	7	21.21	21.28	21.10
		15	0	21.28	21.43	21.10
3M	16QAM	1	0	20.81	21.88	21.05
		1	7	21.19	20.85	20.80
		1	14	21.18	21.39	20.96
		8	0	20.37	20.01	19.98
		8	3	20.36	20.25	20.09
		8	7	20.40	20.11	20.01
		15	0	20.35	20.19	19.92

BW	MCS Index	RB Size	RB Offset	Low	Mid	High
		Channel		19957	20175	20393
		Frequency (MHz)		1710.7	1732.5	1754.3
1.4M	QPSK	1	0	22.10	22.23	21.96
		1	2	22.31	22.43	22.17
		1	5	22.27	22.21	21.95
		3	0	22.28	22.36	22.22
		3	1	22.18	22.41	22.23
		3	3	22.24	22.33	22.09
		6	0	21.32	21.30	21.30
1.4M	16QAM	1	0	21.04	20.80	21.29
		1	2	21.26	21.40	20.85
		1	5	20.89	21.19	20.67
		3	0	21.36	21.18	20.84
		3	1	21.55	20.91	21.22
		3	3	21.46	21.28	21.01
		6	0	20.27	20.26	19.97

EIRP Power (dBm)

BW	MCS Index	RB Size	RB Offset	Low	Mid	High
		Channel		20050	20175	20300
		Frequency (MHz)		1720	1732.5	1745
20M	QPSK	1	0	26.10	26.48	26.29
		1	50	26.31	26.17	26.37
		1	99	26.18	25.89	26.09
		50	0	25.22	25.38	25.40
		50	25	25.33	25.39	25.33
		50	50	25.29	25.21	25.19
		100	0	25.23	25.22	25.27
20M	16QAM	1	0	25.32	25.34	25.58
		1	50	25.52	25.11	25.05
		1	99	24.68	25.26	24.81
		25	0	24.11	24.42	24.43
		25	12	24.28	24.31	24.51
		25	25	24.24	24.46	24.32
		100	0	-	-	-

*EIRP (dBm) = Conducted Output Power (dBm) + Antenna Gain (dBi)

BW	MCS Index	RB Size	RB Offset	Low	Mid	High
		Channel		20025	20175	20325
		Frequency (MHz)		1717.5	1732.5	1747.5
15M	QPSK	1	0	26.34	26.04	26.32
		1	37	26.36	26.10	26.39
		1	74	26.24	25.82	25.98
		36	0	25.14	25.32	25.35
		36	19	25.06	25.17	25.20
		36	39	25.23	25.18	25.16
		75	0	25.15	25.22	25.13
15M	16QAM	1	0	25.04	24.81	25.46
		1	37	24.81	25.05	24.58
		1	74	25.37	24.51	24.93
		25	0	24.17	24.26	24.27
		25	12	24.13	24.27	24.24
		25	25	24.19	24.27	24.20
		75	0	-	-	-

*EIRP (dBm) = Conducted Output Power (dBm) + Antenna Gain (dBi)

BW	MCS Index	RB Size	RB Offset	Low	Mid	High
		Channel		20000	20175	20350
		Frequency (MHz)		1715	1732.5	1750
10M	QPSK	1	0	26.18	25.96	26.14
		1	24	25.88	25.84	25.80
		1	49	26.01	25.96	25.90
		25	0	25.07	25.22	25.13
		25	12	25.19	25.16	25.12
		25	25	25.14	25.16	25.15
		50	0	25.12	25.13	25.09
10M	16QAM	1	0	25.05	25.29	25.56
		1	24	24.56	25.21	25.10
		1	49	24.65	24.44	24.85
		25	0	24.14	24.30	24.16
		25	12	24.21	24.21	24.21
		25	25	24.21	24.19	24.40
		50	0	-	-	-

*EIRP (dBm) = Conducted Output Power (dBm) + Antenna Gain (dBi)

BW	MCS Index	RB Size	RB Offset	Low	Mid	High
		Channel		19975	20175	20375
		Frequency (MHz)		1712.5	1732.5	1752.5
5M	QPSK	1	0	26.03	25.98	26.00
		1	12	26.08	26.04	26.11
		1	24	25.71	25.76	25.89
		12	0	24.96	25.13	25.04
		12	6	25.12	25.10	25.10
		12	13	25.12	25.16	25.15
		25	0	25.15	25.20	25.03
5M	16QAM	1	0	24.65	24.70	24.89
		1	12	25.21	25.16	24.43
		1	24	24.86	24.84	25.16
		12	0	23.89	24.19	23.95
		12	6	24.32	24.07	24.08
		12	13	24.08	24.04	24.14
		25	0	24.08	24.09	24.15

*EIRP (dBm) = Conducted Output Power (dBm) + Antenna Gain (dBi)



BW	MCS Index	RB Size	RB Offset	Low	Mid	High
		Channel		19965	20175	20385
		Frequency (MHz)		1711.5	1732.5	1753.5
3M	QPSK	1	0	26.22	26.24	25.90
		1	7	26.10	26.10	25.97
		1	14	25.89	25.97	25.72
		8	0	25.20	25.19	24.95
		8	3	25.06	25.10	25.03
		8	7	25.08	25.15	24.97
		15	0	25.15	25.30	24.97
3M	16QAM	1	0	24.68	25.75	24.92
		1	7	25.06	24.72	24.67
		1	14	25.05	25.26	24.83
		8	0	24.24	23.88	23.85
		8	3	24.23	24.12	23.96
		8	7	24.27	23.98	23.88
		15	0	24.22	24.06	23.79

*EIRP (dBm) = Conducted Output Power (dBm) + Antenna Gain (dBi)

BW	MCS Index	RB Size	RB Offset	Low	Mid	High
		Channel		19957	20175	20393
		Frequency (MHz)		1710.7	1732.5	1754.3
1.4M	QPSK	1	0	25.97	26.10	25.83
		1	2	26.18	26.30	26.04
		1	5	26.14	26.08	25.82
		3	0	26.15	26.23	26.09
		3	1	26.05	26.28	26.10
		3	3	26.11	26.20	25.96
		6	0	25.19	25.17	25.17
1.4M	16QAM	1	0	24.91	24.67	25.16
		1	2	25.13	25.27	24.72
		1	5	24.76	25.06	24.54
		3	0	25.23	25.05	24.71
		3	1	25.42	24.78	25.09
		3	3	25.33	25.15	24.88
		6	0	24.14	24.13	23.84

*EIRP (dBm) = Conducted Output Power (dBm) + Antenna Gain (dBi)

7.1.6 LTE Band 5

Conducted Output Power (dBm)

BW	MCS Index	RB Size	RB Offset	Low	Mid	High
		Channel		20450	20525	20600
		Frequency (MHz)		829	836.5	844
10M	QPSK	1	0	23.17	23.20	23.26
		1	24	23.12	23.18	23.64
		1	49	23.22	22.98	23.07
		25	0	22.31	22.35	22.37
		25	12	22.33	22.36	22.35
		25	25	22.33	22.25	22.30
		50	0	22.32	22.26	22.35
10M	16QAM	1	0	22.11	22.20	22.33
		1	24	21.85	22.28	22.22
		1	49	22.34	22.21	21.84
		25	0	21.30	21.27	21.36
		25	12	21.27	21.33	21.36
		25	25	21.33	21.17	21.24
		50	0	-	-	-

BW	MCS Index	RB Size	RB Offset	Low	Mid	High
		Channel		20425	20525	20625
		Frequency (MHz)		826.5	836.5	846.5
5M	QPSK	1	0	23.19	23.36	23.17
		1	12	23.44	23.41	23.20
		1	24	22.94	22.93	23.02
		12	0	22.27	22.33	22.30
		12	6	22.26	22.28	22.27
		12	13	22.31	22.29	22.23
		25	0	22.25	22.27	22.19
5M	16QAM	1	0	22.19	21.86	21.90
		1	12	22.07	21.82	22.13
		1	24	21.86	21.90	21.74
		12	0	21.03	21.04	21.01
		12	6	21.11	21.04	21.10
		12	13	21.18	21.01	20.93
		25	0	21.29	21.15	21.00

BW	MCS Index	RB Size	RB Offset	Low	Mid	High
		Channel		20415	20525	20635
		Frequency (MHz)		825.5	836.5	847.5
3M	QPSK	1	0	23.37	23.43	23.35
		1	7	23.23	23.49	23.21
		1	14	23.34	23.14	23.14
		8	0	22.31	22.28	22.31
		8	3	22.25	22.39	22.21
		8	7	22.33	22.39	22.21
		15	0	22.23	22.43	22.23
3M	16QAM	1	0	22.34	22.41	22.02
		1	7	21.96	21.92	21.98
		1	14	22.41	22.41	21.84
		8	0	21.37	21.36	21.53
		8	3	21.58	21.21	21.22
		8	7	21.26	21.50	21.14
		15	0	21.14	21.46	21.24

BW	MCS Index	RB Size	RB Offset	Low	Mid	High
		Channel		20407	20525	20643
		Frequency (MHz)		824.7	836.5	848.3
1.4M	QPSK	1	0	23.05	23.70	23.18
		1	2	23.31	23.51	23.26
		1	5	23.17	23.34	23.14
		3	0	23.28	23.48	23.34
		3	1	23.33	23.31	23.30
		3	3	23.37	23.43	23.18
		6	0	22.21	22.45	22.25
1.4M	16QAM	1	0	22.89	22.11	22.17
		1	2	22.20	22.13	22.63
		1	5	22.36	22.39	21.97
		3	0	22.17	22.35	22.37
		3	1	22.35	22.53	22.30
		3	3	22.47	22.54	22.32
		6	0	21.26	21.52	21.22

ERP Power (dBm)

BW	MCS Index	RB Size	RB Offset	Low	Mid	High
		Channel		20450	20525	20600
		Frequency (MHz)		829	836.5	844
10M	QPSK	1	0	17.80	17.83	17.89
		1	24	17.75	17.81	18.27
		1	49	17.85	17.61	17.70
		25	0	16.94	16.98	17.00
		25	12	16.96	16.99	16.98
		25	25	16.96	16.88	16.93
		50	0	16.95	16.89	16.98
10M	16QAM	1	0	16.74	16.83	16.96
		1	24	16.48	16.91	16.85
		1	49	16.97	16.84	16.47
		25	0	15.93	15.90	15.99
		25	12	15.90	15.96	15.99
		25	25	15.96	15.80	15.87
		50	0	-	-	-

*ERP (dBm) = Conducted Output Power (dBm) + Antenna Gain (dBi) - 2.15

BW	MCS Index	RB Size	RB Offset	Low	Mid	High
		Channel		20425	20525	20625
		Frequency (MHz)		826.5	836.5	846.5
5M	QPSK	1	0	17.82	17.99	17.80
		1	12	18.07	18.04	17.83
		1	24	17.57	17.56	17.65
		12	0	16.90	16.96	16.93
		12	6	16.89	16.91	16.90
		12	13	16.94	16.92	16.86
		25	0	16.88	16.90	16.82
5M	16QAM	1	0	16.82	16.49	16.53
		1	12	16.70	16.45	16.76
		1	24	16.49	16.53	16.37
		12	0	15.66	15.67	15.64
		12	6	15.74	15.67	15.73
		12	13	15.81	15.64	15.56
		25	0	15.92	15.78	15.63

*ERP (dBm) = Conducted Output Power (dBm) + Antenna Gain (dBi) - 2.15



BW	MCS Index	RB Size	RB Offset	Low	Mid	High
		Channel		20415	20525	20635
		Frequency (MHz)		825.5	836.5	847.5
3M	QPSK	1	0	18.00	18.06	17.98
		1	7	17.86	18.12	17.84
		1	14	17.97	17.77	17.77
		8	0	16.94	16.91	16.94
		8	3	16.88	17.02	16.84
		8	7	16.96	17.02	16.84
		15	0	16.86	17.06	16.86
3M	16QAM	1	0	16.97	17.04	16.65
		1	7	16.59	16.55	16.61
		1	14	17.04	17.04	16.47
		8	0	16.00	15.99	16.16
		8	3	16.21	15.84	15.85
		8	7	15.89	16.13	15.77
		15	0	15.77	16.09	15.87

*ERP (dBm) = Conducted Output Power (dBm) + Antenna Gain (dBi) - 2.15

BW	MCS Index	RB Size	RB Offset	Low	Mid	High
		Channel		20407	20525	20643
		Frequency (MHz)		824.7	836.5	848.3
1.4M	QPSK	1	0	17.68	18.33	17.81
		1	2	17.94	18.14	17.89
		1	5	17.80	17.97	17.77
		3	0	17.91	18.11	17.97
		3	1	17.96	17.94	17.93
		3	3	18.00	18.06	17.81
		6	0	16.84	17.08	16.88
1.4M	16QAM	1	0	17.52	16.74	16.80
		1	2	16.83	16.76	17.26
		1	5	16.99	17.02	16.60
		3	0	16.80	16.98	17.00
		3	1	16.98	17.16	16.93
		3	3	17.10	17.17	16.95
		6	0	15.89	16.15	15.85

*ERP (dBm) = Conducted Output Power (dBm) + Antenna Gain (dBi) - 2.15

7.1.7 LTE Band 12

Conducted Output Power (dBm)

BW	MCS Index	RB Size	RB Offset	Low	Mid	High
		Channel		23060	23095	23130
		Frequency (MHz)		704	707.5	711
10M	QPSK	1	0	22.34	23.06	22.70
		1	24	22.73	22.64	22.49
		1	49	22.49	22.38	22.71
		25	0	21.79	21.72	21.83
		25	12	21.85	21.75	21.87
		25	25	21.83	21.73	21.85
		50	0	21.78	21.76	21.96
10M	16QAM	1	0	21.35	21.17	21.27
		1	24	21.50	21.65	22.11
		1	49	21.79	20.90	20.90
		25	0	20.72	20.83	20.76
		25	12	20.84	20.89	20.84
		25	25	20.87	20.73	20.96
		50	0	-	-	-

BW	MCS Index	RB Size	RB Offset	Low	Mid	High
		Channel		23035	23095	23155
		Frequency (MHz)		701.5	707.5	713.5
5M	QPSK	1	0	22.71	22.50	22.57
		1	12	22.89	22.78	22.82
		1	24	22.51	22.32	22.99
		12	0	21.72	21.71	21.84
		12	6	21.81	21.90	21.86
		12	13	21.87	21.70	21.88
		25	0	21.83	21.71	21.88
5M	16QAM	1	0	21.62	21.27	21.80
		1	12	21.30	21.51	21.47
		1	24	21.93	21.58	21.80
		12	0	20.86	20.72	20.84
		12	6	20.82	20.84	20.82
		12	13	20.98	20.63	20.87
		25	0	20.86	20.81	20.96

BW	MCS Index	RB Size	RB Offset	Low	Mid	High
		Channel		23025	23095	23165
		Frequency (MHz)		700.5	707.5	714.5
3M	QPSK	1	0	22.75	22.74	22.69
		1	7	23.14	22.83	22.69
		1	14	22.89	22.55	22.49
		8	0	21.64	21.79	21.81
		8	3	21.75	21.83	21.95
		8	7	21.80	21.79	21.93
		15	0	21.78	21.78	21.92
3M	16QAM	1	0	21.44	21.33	21.53
		1	7	21.75	21.66	21.64
		1	14	21.58	21.58	21.67
		8	0	20.82	20.69	20.69
		8	3	20.92	20.74	21.03
		8	7	21.06	20.91	21.21
		15	0	20.80	20.58	20.63

BW	MCS Index	RB Size	RB Offset	Low	Mid	High
		Channel		23017	23095	23173
		Frequency (MHz)		699.7	707.5	715.3
1.4M	QPSK	1	0	22.54	22.76	23.20
		1	2	22.64	22.95	22.99
		1	5	22.61	22.72	22.72
		3	0	22.88	22.80	22.78
		3	1	22.92	22.97	22.86
		3	3	22.97	22.90	22.80
		6	0	21.77	21.81	21.99
1.4M	16QAM	1	0	22.34	21.68	21.84
		1	2	21.50	21.98	21.68
		1	5	21.67	21.69	21.39
		3	0	21.71	21.76	21.81
		3	1	22.09	21.75	21.95
		3	3	21.56	21.54	21.82
		6	0	20.59	20.88	20.82

ERP Power (dBm)

BW	MCS Index	RB Size	RB Offset	Low	Mid	High
		Channel		23060	23095	23130
		Frequency (MHz)		704	707.5	711
10M	QPSK	1	0	16.98	17.70	17.34
		1	24	17.37	17.28	17.13
		1	49	17.13	17.02	17.35
		25	0	16.43	16.36	16.47
		25	12	16.49	16.39	16.51
		25	25	16.47	16.37	16.49
		50	0	16.42	16.40	16.60
10M	16QAM	1	0	15.99	15.81	15.91
		1	24	16.14	16.29	16.75
		1	49	16.43	15.54	15.54
		25	0	15.36	15.47	15.40
		25	12	15.48	15.53	15.48
		25	25	15.51	15.37	15.60
		50	0	-	-	-

*ERP (dBm) = Conducted Output Power (dBm) + Antenna Gain (dBi) - 2.15

BW	MCS Index	RB Size	RB Offset	Low	Mid	High
		Channel		23035	23095	23155
		Frequency (MHz)		701.5	707.5	713.5
5M	QPSK	1	0	17.35	17.14	17.21
		1	12	17.53	17.42	17.46
		1	24	17.15	16.96	17.63
		12	0	16.36	16.35	16.48
		12	6	16.45	16.54	16.50
		12	13	16.51	16.34	16.52
		25	0	16.47	16.35	16.52
5M	16QAM	1	0	16.26	15.91	16.44
		1	12	15.94	16.15	16.11
		1	24	16.57	16.22	16.44
		12	0	15.50	15.36	15.48
		12	6	15.46	15.48	15.46
		12	13	15.62	15.27	15.51
		25	0	15.50	15.45	15.60

*ERP (dBm) = Conducted Output Power (dBm) + Antenna Gain (dBi) - 2.15

BW	MCS Index	RB Size	RB Offset	Low	Mid	High
		Channel		23025	23095	23165
		Frequency (MHz)		700.5	707.5	714.5
3M	QPSK	1	0	17.39	17.38	17.33
		1	7	17.78	17.47	17.33
		1	14	17.53	17.19	17.13
		8	0	16.28	16.43	16.45
		8	3	16.39	16.47	16.59
		8	7	16.44	16.43	16.57
		15	0	16.42	16.42	16.56
3M	16QAM	1	0	16.08	15.97	16.17
		1	7	16.39	16.30	16.28
		1	14	16.22	16.22	16.31
		8	0	15.46	15.33	15.33
		8	3	15.56	15.38	15.67
		8	7	15.70	15.55	15.85
		15	0	15.44	15.22	15.27

*ERP (dBm) = Conducted Output Power (dBm) + Antenna Gain (dBi) - 2.15

BW	MCS Index	RB Size	RB Offset	Low	Mid	High
		Channel		23017	23095	23173
		Frequency (MHz)		699.7	707.5	715.3
1.4M	QPSK	1	0	17.18	17.40	17.84
		1	2	17.28	17.59	17.63
		1	5	17.25	17.36	17.36
		3	0	17.52	17.44	17.42
		3	1	17.56	17.61	17.50
		3	3	17.61	17.54	17.44
		6	0	16.41	16.45	16.63
1.4M	16QAM	1	0	16.98	16.32	16.48
		1	2	16.14	16.62	16.32
		1	5	16.31	16.33	16.03
		3	0	16.35	16.40	16.45
		3	1	16.73	16.39	16.59
		3	3	16.20	16.18	16.46
		6	0	15.23	15.52	15.46

*ERP (dBm) = Conducted Output Power (dBm) + Antenna Gain (dBi) - 2.15

7.1.8 LTE Band 25
Conducted Output Power (dBm)

BW	MCS Index	RB Size	RB Offset	Low	Mid	High
		Channel		26140	26365	26590
		Frequency (MHz)		1860	1882.5	1905
20M	QPSK	1	0	22.33	22.44	22.21
		1	50	22.30	22.21	21.83
		1	99	22.08	21.76	22.00
		50	0	21.19	21.08	21.24
		50	25	21.25	21.07	21.21
		50	50	21.22	21.09	21.20
		100	0	21.24	21.06	21.24
20M	16QAM	1	0	21.15	21.06	20.85
		1	50	21.32	21.20	21.12
		1	99	20.85	21.02	21.15
		25	0	20.17	20.15	20.36
		25	12	20.24	20.08	20.10
		25	25	20.09	20.07	20.29
		100	0	-	-	-

BW	MCS Index	RB Size	RB Offset	Low	Mid	High
		Channel		26115	26365	26615
		Frequency (MHz)		1857.5	1882.5	1907.5
15M	QPSK	1	0	22.25	22.11	22.28
		1	37	22.00	21.79	22.24
		1	74	22.17	21.80	22.04
		36	0	21.17	21.14	21.24
		36	19	21.12	21.09	21.14
		36	39	21.09	21.08	21.18
		75	0	21.05	21.11	21.09
15M	16QAM	1	0	20.92	21.52	21.14
		1	37	20.67	20.59	20.50
		1	74	20.56	20.57	21.02
		25	0	20.31	19.99	20.19
		25	12	20.09	19.95	20.18
		25	25	20.09	20.22	19.99
		75	0	-	-	-

BW	MCS Index	RB Size	RB Offset	Low	Mid	High
		Channel		26090	26365	26640
		Frequency (MHz)		1855	1882.5	1910
10M	QPSK	1	0	22.18	22.32	22.13
		1	24	22.08	22.29	21.96
		1	49	22.15	21.74	22.04
		25	0	21.26	21.13	21.21
		25	12	21.26	21.09	21.26
		25	25	21.09	21.11	21.20
		50	0	21.17	21.05	21.24
10M	16QAM	1	0	20.73	21.15	20.88
		1	24	20.79	20.86	20.63
		1	49	21.08	20.44	21.00
		25	0	20.27	20.07	20.22
		25	12	20.22	20.18	20.16
		25	25	20.41	20.09	20.38
		50	0	-	-	-

BW	MCS Index	RB Size	RB Offset	Low	Mid	High
		Channel		26065	26365	26665
		Frequency (MHz)		1852.5	1882.5	1912.5
5M	QPSK	1	0	22.00	21.76	22.32
		1	12	22.07	21.72	22.25
		1	24	21.93	21.83	22.22
		12	0	21.16	21.01	21.29
		12	6	21.16	21.06	21.27
		12	13	21.19	21.10	21.29
		25	0	21.18	21.06	21.27
5M	16QAM	1	0	20.75	20.94	20.82
		1	12	20.52	20.70	21.03
		1	24	20.73	20.44	21.28
		12	0	20.15	19.86	20.14
		12	6	20.13	19.88	20.26
		12	13	19.95	19.97	20.27
		25	0	20.20	20.14	20.32

BW	MCS Index	RB Size	RB Offset	Low	Mid	High
		Channel		26055	26365	26675
		Frequency (MHz)		1851.5	1882.5	1913.5
3M	QPSK	1	0	21.89	21.73	22.04
		1	7	21.95	21.96	22.08
		1	14	21.81	21.85	22.01
		8	0	21.10	21.07	21.31
		8	3	21.14	21.12	21.35
		8	7	21.12	21.12	21.35
		15	0	21.12	20.99	21.38
3M	16QAM	1	0	20.85	20.39	21.07
		1	7	20.69	20.54	20.75
		1	14	20.80	20.79	21.08
		8	0	19.91	19.74	19.99
		8	3	19.93	19.95	20.09
		8	7	19.86	20.15	20.00
		15	0	20.00	20.00	20.13

BW	MCS Index	RB Size	RB Offset	Low	Mid	High
		Channel		26047	26365	26683
		Frequency (MHz)		1850.7	1882.5	1914.3
1.4M	QPSK	1	0	22.06	22.31	22.11
		1	2	22.16	22.37	22.11
		1	5	22.08	21.82	22.14
		3	0	22.27	21.87	22.09
		3	1	22.33	21.97	22.13
		3	3	22.19	22.04	22.18
		6	0	21.17	21.06	21.18
1.4M	16QAM	1	0	20.90	20.47	21.27
		1	2	21.13	20.79	20.65
		1	5	20.56	21.15	20.65
		3	0	21.12	21.07	21.23
		3	1	21.00	21.08	21.13
		3	3	21.16	20.97	21.14
		6	0	20.17	20.01	19.90



EIRP Power (dBm)

BW	MCS Index	RB Size	RB Offset	Low	Mid	High
		Channel		26140	26365	26590
		Frequency (MHz)		1860	1882.5	1905
20M	QPSK	1	0	25.71	25.82	25.59
		1	50	25.68	25.59	25.21
		1	99	25.46	25.14	25.38
		50	0	24.57	24.46	24.62
		50	25	24.63	24.45	24.59
		50	50	24.60	24.47	24.58
		100	0	24.62	24.44	24.62
20M	16QAM	1	0	24.53	24.44	24.23
		1	50	24.70	24.58	24.50
		1	99	24.23	24.40	24.53
		25	0	23.55	23.53	23.74
		25	12	23.62	23.46	23.48
		25	25	23.47	23.45	23.67
		100	0	-	-	-

*EIRP (dBm) = Conducted Output Power (dBm) + Antenna Gain (dBi)

BW	MCS Index	RB Size	RB Offset	Low	Mid	High
		Channel		26115	26365	26615
		Frequency (MHz)		1857.5	1882.5	1907.5
15M	QPSK	1	0	25.63	25.49	25.66
		1	37	25.38	25.17	25.62
		1	74	25.55	25.18	25.42
		36	0	24.55	24.52	24.62
		36	19	24.50	24.47	24.52
		36	39	24.47	24.46	24.56
		75	0	24.43	24.49	24.47
15M	16QAM	1	0	24.30	24.90	24.52
		1	37	24.05	23.97	23.88
		1	74	23.94	23.95	24.40
		25	0	23.69	23.37	23.57
		25	12	23.47	23.33	23.56
		25	25	23.47	23.60	23.37
		75	0	-	-	-

*EIRP (dBm) = Conducted Output Power (dBm) + Antenna Gain (dBi)

BW	MCS Index	RB Size	RB Offset	Low	Mid	High
		Channel		26090	26365	26640
		Frequency (MHz)		1855	1882.5	1910
10M	QPSK	1	0	25.56	25.70	25.51
		1	24	25.46	25.67	25.34
		1	49	25.53	25.12	25.42
		25	0	24.64	24.51	24.59
		25	12	24.64	24.47	24.64
		25	25	24.47	24.49	24.58
		50	0	24.55	24.43	24.62
10M	16QAM	1	0	24.11	24.53	24.26
		1	24	24.17	24.24	24.01
		1	49	24.46	23.82	24.38
		25	0	23.65	23.45	23.60
		25	12	23.60	23.56	23.54
		25	25	23.79	23.47	23.76
		50	0	-	-	-

*EIRP (dBm) = Conducted Output Power (dBm) + Antenna Gain (dBi)

BW	MCS Index	RB Size	RB Offset	Low	Mid	High
		Channel		26065	26365	26665
		Frequency (MHz)		1852.5	1882.5	1912.5
5M	QPSK	1	0	25.38	25.14	25.70
		1	12	25.45	25.10	25.63
		1	24	25.31	25.21	25.60
		12	0	24.54	24.39	24.67
		12	6	24.54	24.44	24.65
		12	13	24.57	24.48	24.67
		25	0	24.56	24.44	24.65
5M	16QAM	1	0	24.13	24.32	24.20
		1	12	23.90	24.08	24.41
		1	24	24.11	23.82	24.66
		12	0	23.53	23.24	23.52
		12	6	23.51	23.26	23.64
		12	13	23.33	23.35	23.65
		25	0	23.58	23.52	23.70

*EIRP (dBm) = Conducted Output Power (dBm) + Antenna Gain (dBi)

BW	MCS Index	RB Size	RB Offset	Low	Mid	High
		Channel		26055	26365	26675
		Frequency (MHz)		1851.5	1882.5	1913.5
3M	QPSK	1	0	25.27	25.11	25.42
		1	7	25.33	25.34	25.46
		1	14	25.19	25.23	25.39
		8	0	24.48	24.45	24.69
		8	3	24.52	24.50	24.73
		8	7	24.50	24.50	24.73
		15	0	24.50	24.37	24.76
3M	16QAM	1	0	24.23	23.77	24.45
		1	7	24.07	23.92	24.13
		1	14	24.18	24.17	24.46
		8	0	23.29	23.12	23.37
		8	3	23.31	23.33	23.47
		8	7	23.24	23.53	23.38
		15	0	23.38	23.38	23.51

*EIRP (dBm) = Conducted Output Power (dBm) + Antenna Gain (dBi)

BW	MCS Index	RB Size	RB Offset	Low	Mid	High
		Channel		26047	26365	26683
		Frequency (MHz)		1850.7	1882.5	1914.3
1.4M	QPSK	1	0	25.44	25.69	25.49
		1	2	25.54	25.75	25.49
		1	5	25.46	25.20	25.52
		3	0	25.65	25.25	25.47
		3	1	25.71	25.35	25.51
		3	3	25.57	25.42	25.56
		6	0	24.55	24.44	24.56
1.4M	16QAM	1	0	24.28	23.85	24.65
		1	2	24.51	24.17	24.03
		1	5	23.94	24.53	24.03
		3	0	24.50	24.45	24.61
		3	1	24.38	24.46	24.51
		3	3	24.54	24.35	24.52
		6	0	23.55	23.39	23.28

*EIRP (dBm) = Conducted Output Power (dBm) + Antenna Gain (dBi)

7.1.9 LTE Band 26 (814 MHz ~ 824 MHz)
Conducted Output Power (dBm)

BW	MCS Index	RB Size	RB Offset	Mid
		Channel		26740
		Frequency (MHz)		819
10M	QPSK	1	0	23.25
		1	24	23.16
		1	49	23.02
		25	0	22.01
		25	12	22.03
		25	25	22.11
		50	0	21.96
10M	16QAM	1	0	22.13
		1	24	22.11
		1	49	21.73
		25	0	21.31
		25	12	20.83
		25	25	20.90
		50	0	-

BW	MCS Index	RB Size	RB Offset	Low	Mid	High
		Channel		26715	26740	26765
		Frequency (MHz)		816.5	819	821.5
5M	QPSK	1	0	22.89	23.01	22.85
		1	12	22.90	23.00	23.23
		1	24	22.82	22.71	23.16
		12	0	22.12	21.93	21.99
		12	6	22.11	22.08	21.99
		12	13	22.09	22.13	22.03
		25	0	22.11	22.00	21.93
5M	16QAM	1	0	22.08	21.66	21.38
		1	12	21.62	22.17	22.29
		1	24	21.56	22.00	21.78
		12	0	21.21	20.95	20.94
		12	6	21.24	21.02	20.85
		12	13	21.12	20.90	20.91
		25	0	21.02	21.03	21.05

BW	MCS Index	RB Size	RB Offset	Low	Mid	High
		Channel		26705	26740	26775
		Frequency (MHz)		815.5	819	822.5
3M	QPSK	1	0	22.70	22.86	22.92
		1	7	23.06	22.90	23.08
		1	14	22.80	22.94	23.03
		8	0	22.22	21.99	22.13
		8	3	22.21	22.00	22.16
		8	7	22.18	22.02	22.08
		15	0	22.09	22.06	22.11
3M	16QAM	1	0	21.92	22.25	21.82
		1	7	21.75	21.72	21.74
		1	14	21.72	21.72	21.83
		8	0	21.07	20.81	21.12
		8	3	21.34	20.85	21.22
		8	7	21.22	20.85	21.19
		15	0	21.01	20.97	20.98

BW	MCS Index	RB Size	RB Offset	Low	Mid	High
		Channel		26697	26740	26783
		Frequency (MHz)		814.7	819	823.3
1.4M	QPSK	1	0	23.04	23.11	23.14
		1	7	23.18	23.10	23.16
		1	14	23.05	23.09	23.21
		8	0	22.75	22.74	22.85
		8	3	22.75	22.91	23.07
		8	7	22.66	22.81	23.07
		15	0	22.04	22.00	22.10
1.4M	16QAM	1	0	22.02	22.11	22.08
		1	7	21.77	22.00	22.20
		1	14	21.58	22.10	21.83
		8	0	21.96	22.19	22.17
		8	3	21.97	21.78	22.15
		8	7	22.18	22.18	22.11
		15	0	21.04	21.04	21.08

ERP Power (dBm)

BW	MCS Index	RB Size	RB Offset	Mid
		Channel		26740
		Frequency (MHz)		819
10M	QPSK	1	0	20.44
		1	24	20.35
		1	49	20.21
		25	0	19.20
		25	12	19.22
		25	25	19.30
		50	0	19.15
10M	16QAM	1	0	19.32
		1	24	19.30
		1	49	18.92
		25	0	18.50
		25	12	18.02
		25	25	18.09
		50	0	-

*ERP (dBm) = Conducted Output Power (dBm) + Antenna Gain (dBi) - 2.15

BW	MCS Index	RB Size	RB Offset	Low	Mid	High
		Channel		26715	26740	26765
		Frequency (MHz)		816.5	819	821.5
5M	QPSK	1	0	20.08	20.20	20.04
		1	12	20.09	20.19	20.42
		1	24	20.01	19.90	20.35
		12	0	19.31	19.12	19.18
		12	6	19.30	19.27	19.18
		12	13	19.28	19.32	19.22
		25	0	19.30	19.19	19.12
5M	16QAM	1	0	19.27	18.85	18.57
		1	12	18.81	19.36	19.48
		1	24	18.75	19.19	18.97
		12	0	18.40	18.14	18.13
		12	6	18.43	18.21	18.04
		12	13	18.31	18.09	18.10
		25	0	18.21	18.22	18.24

*ERP (dBm) = Conducted Output Power (dBm) + Antenna Gain (dBi) - 2.15

BW	MCS Index	RB Size	RB Offset	Low	Mid	High
		Channel		26705	26740	26775
		Frequency (MHz)		815.5	819	822.5
3M	QPSK	1	0	19.89	20.05	20.11
		1	7	20.25	20.09	20.27
		1	14	19.99	20.13	20.22
		8	0	19.41	19.18	19.32
		8	3	19.40	19.19	19.35
		8	7	19.37	19.21	19.27
		15	0	19.28	19.25	19.30
3M	16QAM	1	0	19.11	19.44	19.01
		1	7	18.94	18.91	18.93
		1	14	18.91	18.91	19.02
		8	0	18.26	18.00	18.31
		8	3	18.53	18.04	18.41
		8	7	18.41	18.04	18.38
		15	0	18.20	18.16	18.17

*ERP (dBm) = Conducted Output Power (dBm) + Antenna Gain (dBi) - 2.15

BW	MCS Index	RB Size	RB Offset	Low	Mid	High
		Channel		26697	26740	26783
		Frequency (MHz)		814.7	819	823.3
1.4M	QPSK	1	0	20.23	20.30	20.33
		1	7	20.37	20.29	20.35
		1	14	20.24	20.28	20.40
		8	0	19.94	19.93	20.04
		8	3	19.94	20.10	20.26
		8	7	19.85	20.00	20.26
		15	0	19.23	19.19	19.29
1.4M	16QAM	1	0	19.21	19.30	19.27
		1	7	18.96	19.19	19.39
		1	14	18.77	19.29	19.02
		8	0	19.15	19.38	19.36
		8	3	19.16	18.97	19.34
		8	7	19.37	19.37	19.30
		15	0	18.23	18.23	18.27

*ERP (dBm) = Conducted Output Power (dBm) + Antenna Gain (dBi) - 2.15

7.1.10LTE Band 26 (824 MHz ~ 849 MHz)
Conducted Output Power (dBm)

BW	MCS Index	RB Size	RB Offset	Low	Mid	High
		Channel		26865	26915	26965
		Frequency (MHz)		831.5	836.5	841.5
15M	QPSK	1	0	23.26	23.29	23.20
		1	37	23.12	23.15	23.13
		1	74	22.92	23.21	23.14
		36	0	22.26	22.29	22.18
		36	19	22.28	22.11	22.24
		36	39	22.23	22.18	22.17
		75	0	22.19	22.06	22.11
15M	16QAM	1	0	22.30	22.47	22.27
		1	37	21.73	22.20	21.90
		1	74	22.00	21.92	21.91
		25	0	21.09	21.32	21.20
		25	12	21.12	21.19	21.04
		25	25	21.05	21.16	21.11
		75	0	-	-	-

BW	MCS Index	RB Size	RB Offset	Low	Mid	High
		Channel		26840	26915	26990
		Frequency (MHz)		829	836.5	844
10M	QPSK	1	0	23.26	23.11	23.17
		1	37	23.09	23.05	23.04
		1	74	23.03	23.14	23.04
		36	0	22.20	22.18	22.31
		36	19	22.20	22.16	22.29
		36	39	22.28	22.10	22.33
		75	0	22.24	22.11	22.28
10M	16QAM	1	0	22.24	22.28	21.99
		1	37	22.29	22.23	21.93
		1	74	22.51	21.96	22.00
		36	0	21.25	21.16	21.43
		36	19	21.20	21.25	21.27
		36	39	21.44	21.28	21.60
		75	0	-	-	-

BW	MCS Index	RB Size	RB Offset	Low	Mid	High
		Channel		26815	26915	27015
		Frequency (MHz)		826.5	836.5	846.5
5M	QPSK	1	0	22.83	23.01	22.94
		1	12	22.98	22.98	23.06
		1	24	23.16	23.22	22.74
		12	0	22.10	22.22	22.20
		12	6	22.20	22.18	22.23
		12	13	22.22	22.09	22.23
		25	0	22.16	22.18	22.28
5M	16QAM	1	0	21.66	21.88	21.67
		1	12	22.15	21.54	22.28
		1	24	22.06	22.16	22.13
		12	0	21.13	21.06	20.98
		12	6	21.02	20.94	21.08
		12	13	21.10	20.86	21.21
		25	0	21.15	20.97	21.23

BW	MCS Index	RB Size	RB Offset	Low	Mid	High
		Channel		26805	26915	27025
		Frequency (MHz)		825.5	836.5	847.5
3M	QPSK	1	0	23.25	23.22	23.07
		1	7	22.36	23.12	23.23
		1	14	23.22	23.10	23.11
		8	0	22.15	22.11	22.34
		8	3	22.20	22.11	22.23
		8	7	22.18	22.12	22.25
		15	0	22.18	22.15	22.35
3M	16QAM	1	0	22.62	21.92	21.98
		1	7	22.44	21.76	22.16
		1	14	22.42	22.61	21.94
		8	0	21.15	21.16	21.36
		8	3	21.40	21.17	21.20
		8	7	21.13	21.32	21.29
		15	0	21.28	21.20	21.26



BW	MCS Index	RB Size	RB Offset	Low	Mid	High
		Channel		26797	26915	27033
		Frequency (MHz)		824.7	836.5	848.3
1.4M	QPSK	1	0	22.98	23.09	23.27
		1	2	23.23	23.06	23.19
		1	5	23.07	22.91	22.98
		3	0	23.20	23.04	23.18
		3	1	23.22	23.05	23.25
		3	3	23.19	22.99	23.21
		6	0	22.26	22.12	22.29
1.4M	16QAM	1	0	22.24	22.28	22.03
		1	2	21.59	22.66	22.30
		1	5	22.10	22.08	21.53
		3	0	22.47	22.10	22.42
		3	1	22.52	22.39	22.43
		3	3	22.46	22.35	22.37
		6	0	21.22	21.19	21.13

ERP Power (dBm)

BW	MCS Index	RB Size	RB Offset	Low	Mid	High
		Channel		26865	26915	26965
		Frequency (MHz)		831.5	836.5	841.5
15M	QPSK	1	0	17.89	17.92	17.83
		1	37	17.75	17.78	17.76
		1	74	17.55	17.84	17.77
		36	0	16.89	16.92	16.81
		36	19	16.91	16.74	16.87
		36	39	16.86	16.81	16.80
		75	0	16.82	16.69	16.74
15M	16QAM	1	0	16.93	17.10	16.90
		1	37	16.36	16.83	16.53
		1	74	16.63	16.55	16.54
		25	0	15.72	15.95	15.83
		25	12	15.75	15.82	15.67
		25	25	15.68	15.79	15.74
		75	0	-	-	-

*ERP (dBm) = Conducted Output Power (dBm) + Antenna Gain (dBi) - 2.15

BW	MCS Index	RB Size	RB Offset	Low	Mid	High
		Channel		26840	26915	26990
		Frequency (MHz)		829	836.5	844
10M	QPSK	1	0	17.89	17.74	17.80
		1	37	17.72	17.68	17.67
		1	74	17.66	17.77	17.67
		36	0	16.83	16.81	16.94
		36	19	16.83	16.79	16.92
		36	39	16.91	16.73	16.96
		75	0	16.87	16.74	16.91
10M	16QAM	1	0	16.87	16.91	16.62
		1	37	16.92	16.86	16.56
		1	74	17.14	16.59	16.63
		36	0	15.88	15.79	16.06
		36	19	15.83	15.88	15.90
		36	39	16.07	15.91	16.23
		75	0	-	-	-

*ERP (dBm) = Conducted Output Power (dBm) + Antenna Gain (dBi) - 2.15

BW	MCS Index	RB Size	RB Offset	Low	Mid	High
		Channel		26815	26915	27015
		Frequency (MHz)		826.5	836.5	846.5
5M	QPSK	1	0	17.46	17.64	17.57
		1	12	17.61	17.61	17.69
		1	24	17.79	17.85	17.37
		12	0	16.73	16.85	16.83
		12	6	16.83	16.81	16.86
		12	13	16.85	16.72	16.86
		25	0	16.79	16.81	16.91
5M	16QAM	1	0	16.29	16.51	16.30
		1	12	16.78	16.17	16.91
		1	24	16.69	16.79	16.76
		12	0	15.76	15.69	15.61
		12	6	15.65	15.57	15.71
		12	13	15.73	15.49	15.84
		25	0	15.78	15.60	15.86

*ERP (dBm) = Conducted Output Power (dBm) + Antenna Gain (dBi) - 2.15

BW	MCS Index	RB Size	RB Offset	Low	Mid	High
		Channel		26805	26915	27025
		Frequency (MHz)		825.5	836.5	847.5
3M	QPSK	1	0	17.88	17.85	17.70
		1	7	16.99	17.75	17.86
		1	14	17.85	17.73	17.74
		8	0	16.78	16.74	16.97
		8	3	16.83	16.74	16.86
		8	7	16.81	16.75	16.88
		15	0	16.81	16.78	16.98
3M	16QAM	1	0	17.25	16.55	16.61
		1	7	17.07	16.39	16.79
		1	14	17.05	17.24	16.57
		8	0	15.78	15.79	15.99
		8	3	16.03	15.80	15.83
		8	7	15.76	15.95	15.92
		15	0	15.91	15.83	15.89

*ERP (dBm) = Conducted Output Power (dBm) + Antenna Gain (dBi) - 2.15



BW	MCS Index	RB Size	RB Offset	Low	Mid	High
		Channel		26797	26915	27033
		Frequency (MHz)		824.7	836.5	848.3
1.4M	QPSK	1	0	17.61	17.72	17.90
		1	2	17.86	17.69	17.82
		1	5	17.70	17.54	17.61
		3	0	17.83	17.67	17.81
		3	1	17.85	17.68	17.88
		3	3	17.82	17.62	17.84
		6	0	16.89	16.75	16.92
1.4M	16QAM	1	0	16.87	16.91	16.66
		1	2	16.22	17.29	16.93
		1	5	16.73	16.71	16.16
		3	0	17.10	16.73	17.05
		3	1	17.15	17.02	17.06
		3	3	17.09	16.98	17.00
		6	0	15.85	15.82	15.76

*ERP (dBm) = Conducted Output Power (dBm) + Antenna Gain (dBi) - 2.15

7.2 Modulation Characteristics

Input Power:	3.6 Vdc	Environmental Conditions:	21°C, 70% RH	Tested By:	Willy Cheng
--------------	---------	---------------------------	--------------	------------	-------------

7.2.1 WCDMA Band 2

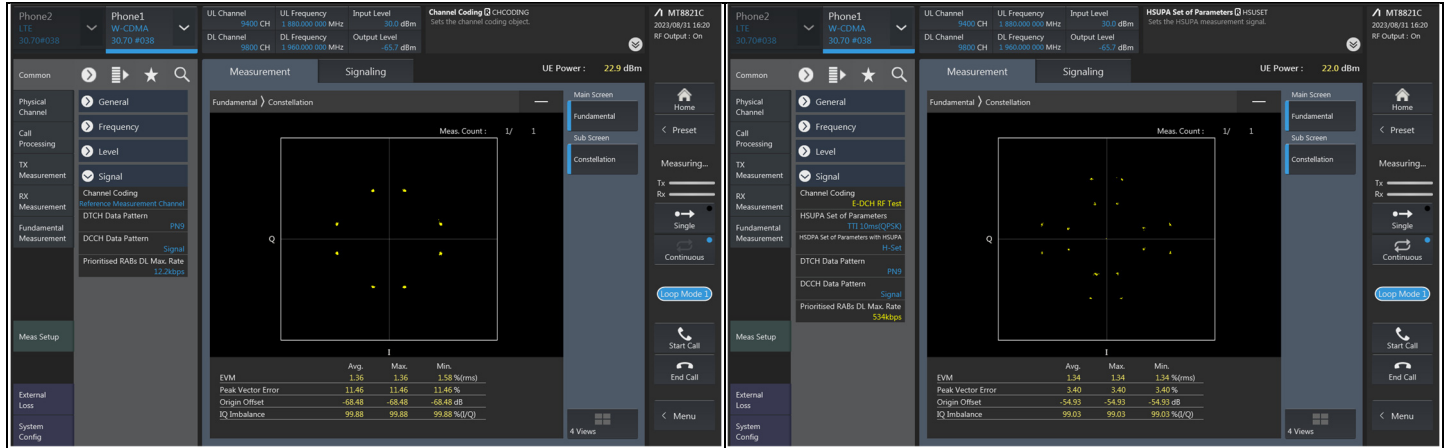

WCDMA CH 9400 (1880 MHz)

HSPA CH 9400 (1880 MHz)

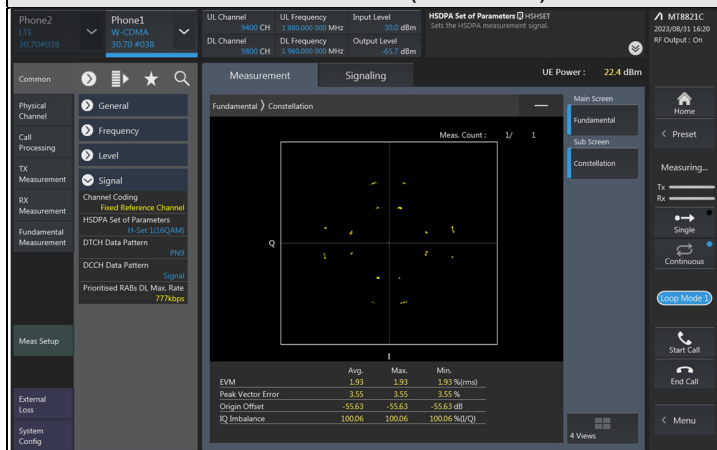

HSDPA CH 9400 (1880 MHz)

7.2.2 WCDMA Band 4

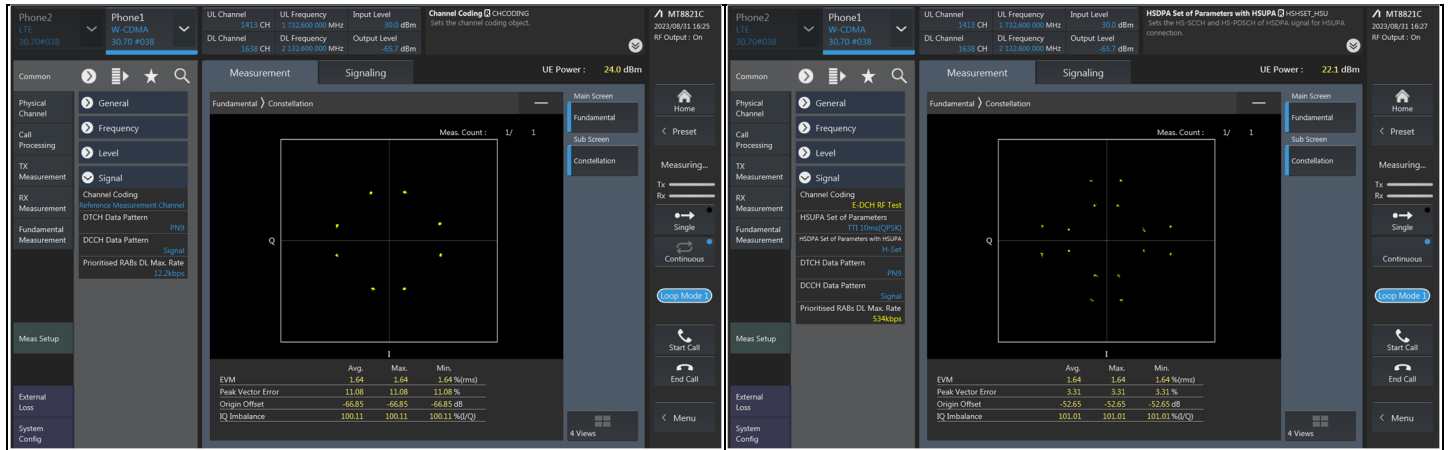

WCDMA CH 1413 (1732.6 MHz)

HSDPA CH 1413 (1732.6 MHz)

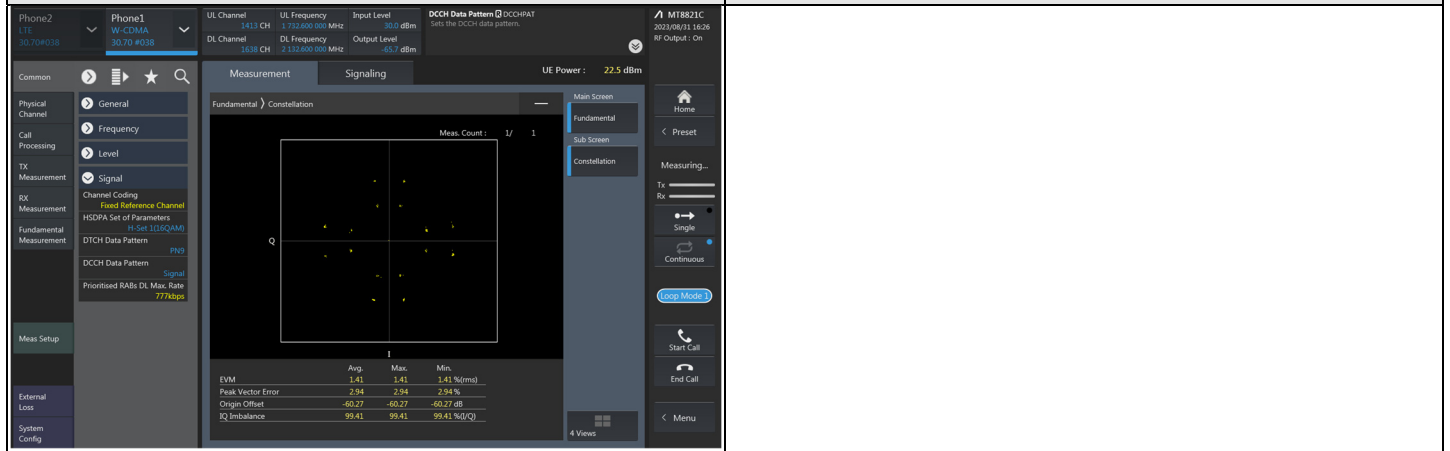

HSDPA CH 1413 (1732.6 MHz)

7.2.3 WCDMA Band 5

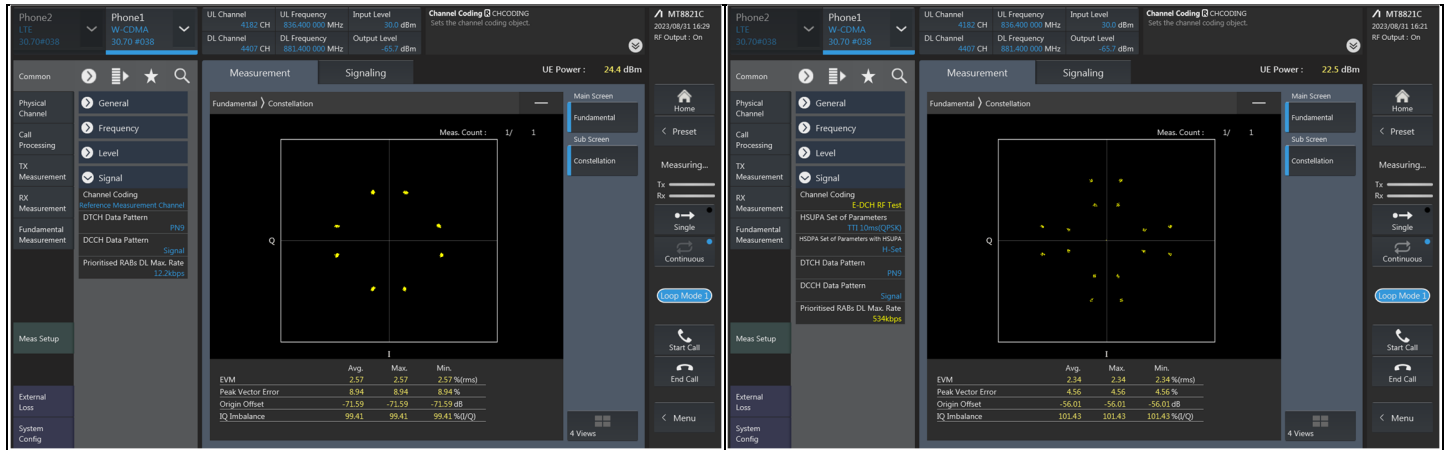

WCDMA CH 4182 (836.4 MHz)

HSPA CH 4182 (836.4 MHz)

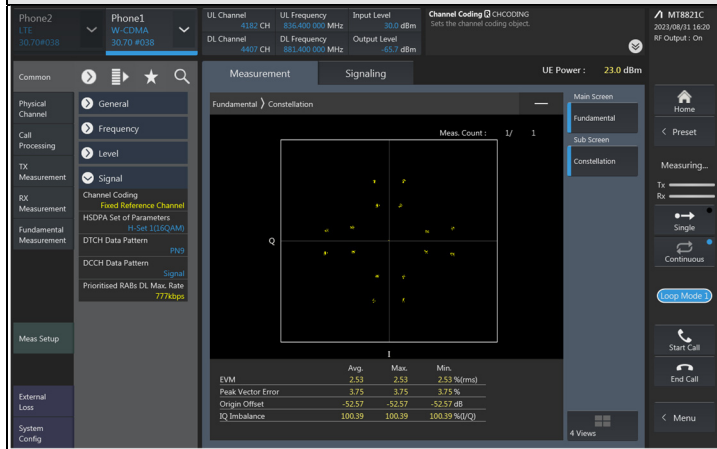

HSDPA CH 4182 (836.4 MHz)

7.2.4 LTE Band 2

LTE Band 2, Channel Bandwidth: 20 MHz



7.2.5 LTE Band 4

LTE Band 4, Channel Bandwidth: 20 MHz



7.2.6 LTE Band 5

LTE Band 5, Channel Bandwidth: 10 MHz



7.2.7 LTE Band 12

LTE Band 12, Channel Bandwidth: 10 MHz

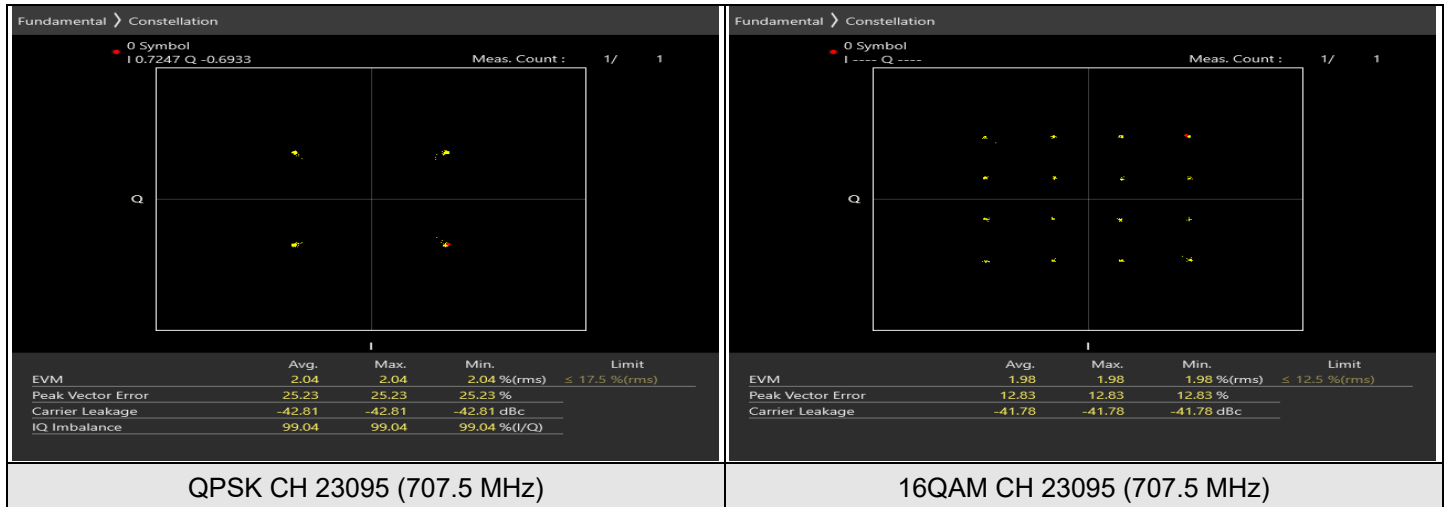

7.2.8 LTE Band 25

LTE Band 25, Channel Bandwidth: 20 MHz

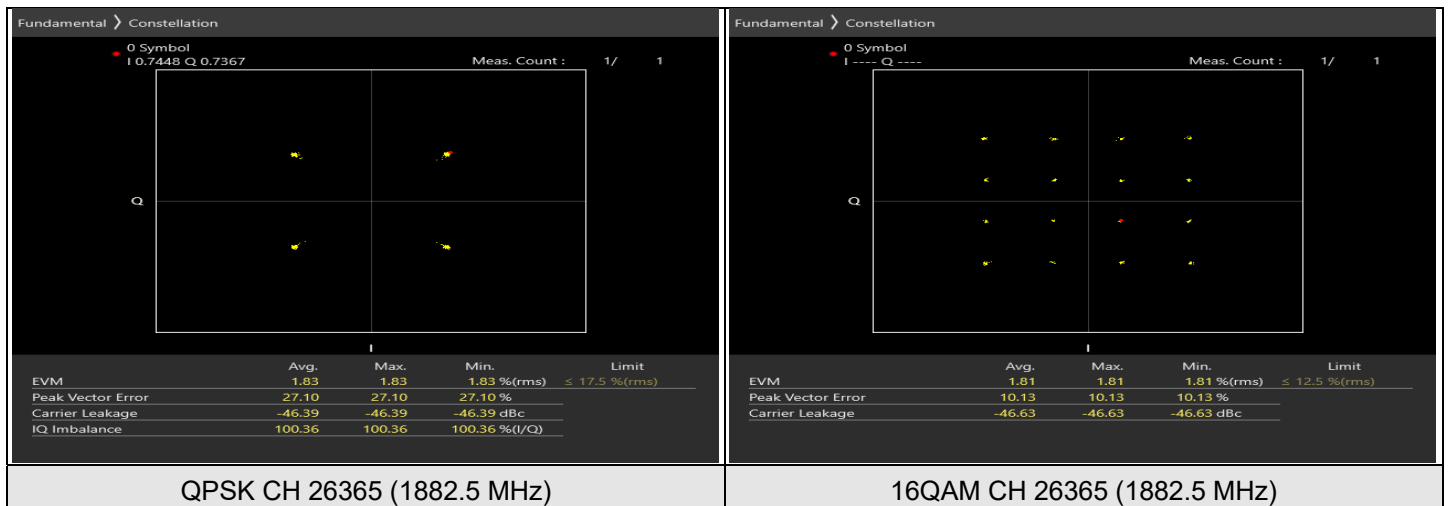

7.2.9 LTE Band 26 (814 MHz ~ 824 MHz)

LTE Band 26 (814 MHz ~ 824 MHz), Channel Bandwidth: 10 MHz

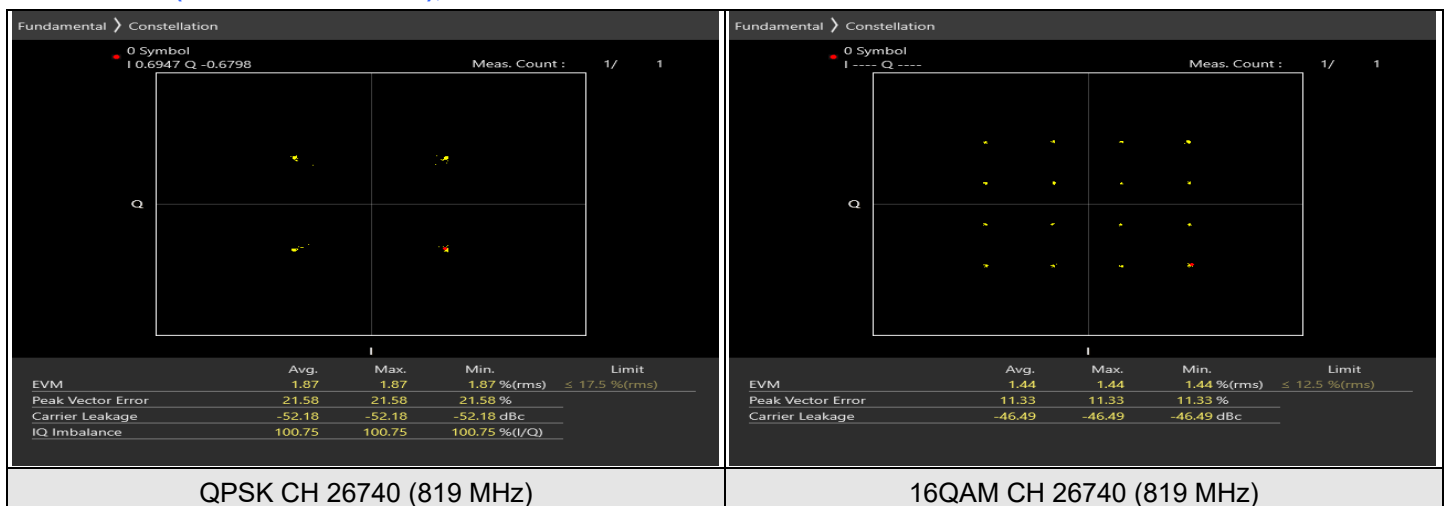

7.2.10LTE Band 26 (824 MHz ~ 849 MHz)

LTE Band 26 (824 MHz ~ 849 MHz), Channel Bandwidth: 15 MHz

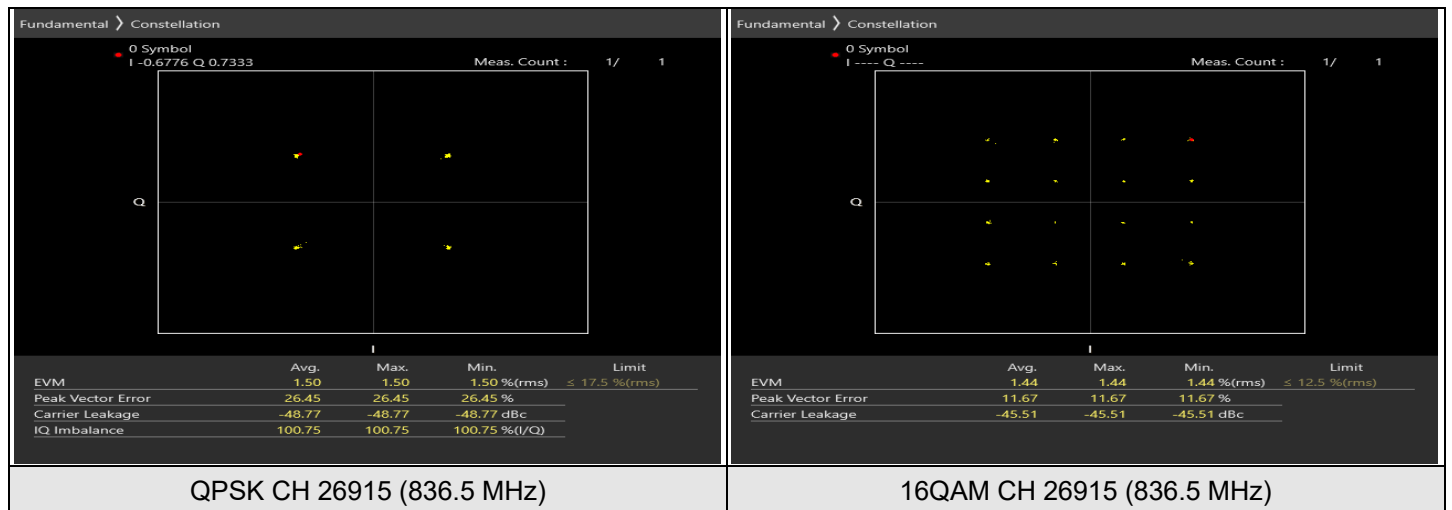

7.3 Peak to Average Ratio

Input Power:	3.6 Vdc	Environmental Conditions:	21°C, 70% RH	Tested By:	Willy Cheng
--------------	---------	---------------------------	--------------	------------	-------------

7.3.1 WCDMA Band 2

Modulation	Channel	Frequency (MHz)	Measurement Value(dB)	Limit (dB)	Result
WCDMA	9262	1852.4	3.07	13	Pass
WCDMA	9400	1880	3.04	13	Pass
WCDMA	9538	1907.6	2.97	13	Pass
HSDPA	9262	1852.4	3.79	13	Pass
HSDPA	9400	1880	3.78	13	Pass
HSDPA	9538	1907.6	3.69	13	Pass
HSUPA	9262	1852.4	3.81	13	Pass
HSUPA	9400	1880	3.79	13	Pass
HSUPA	9538	1907.6	3.69	13	Pass

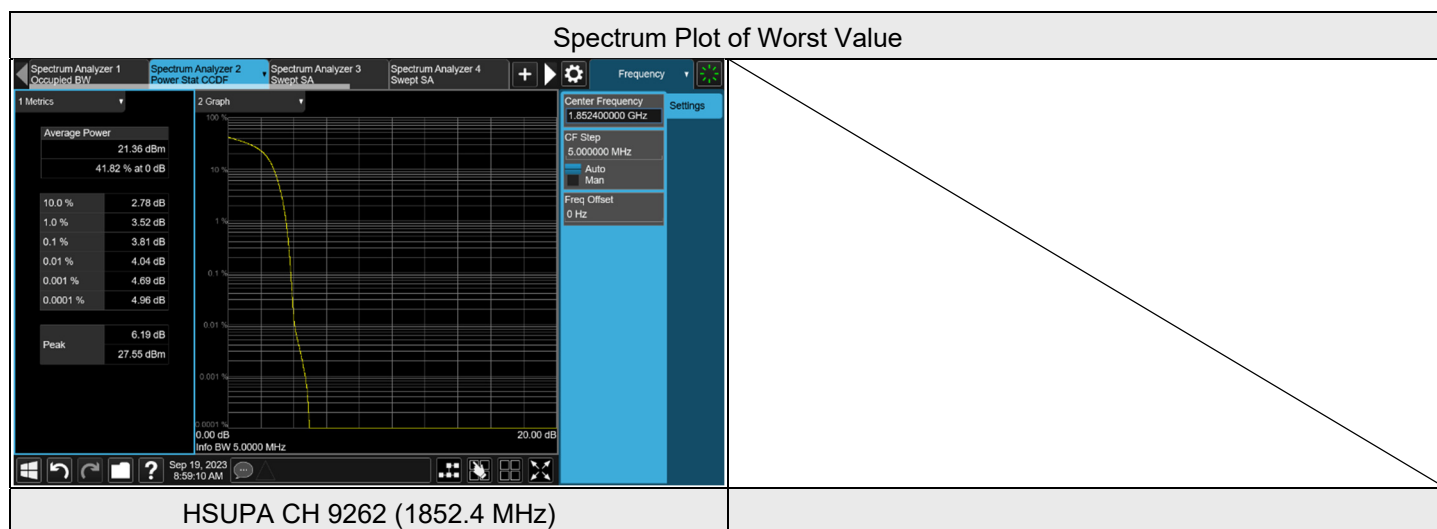

7.3.2 WCDMA Band 4

Modulation	Channel	Frequency (MHz)	Measurement Value(dB)	Limit (dB)	Result
WCDMA	1312	1712.4	3.15	13	Pass
WCDMA	1413	1732.6	3.05	13	Pass
WCDMA	1513	1752.6	2.79	13	Pass
HSDPA	1312	1712.4	3.85	13	Pass
HSDPA	1413	1732.6	3.76	13	Pass
HSDPA	1513	1752.6	3.55	13	Pass
HSUPA	1312	1712.4	3.87	13	Pass
HSUPA	1413	1732.6	3.78	13	Pass
HSUPA	1513	1752.6	3.58	13	Pass

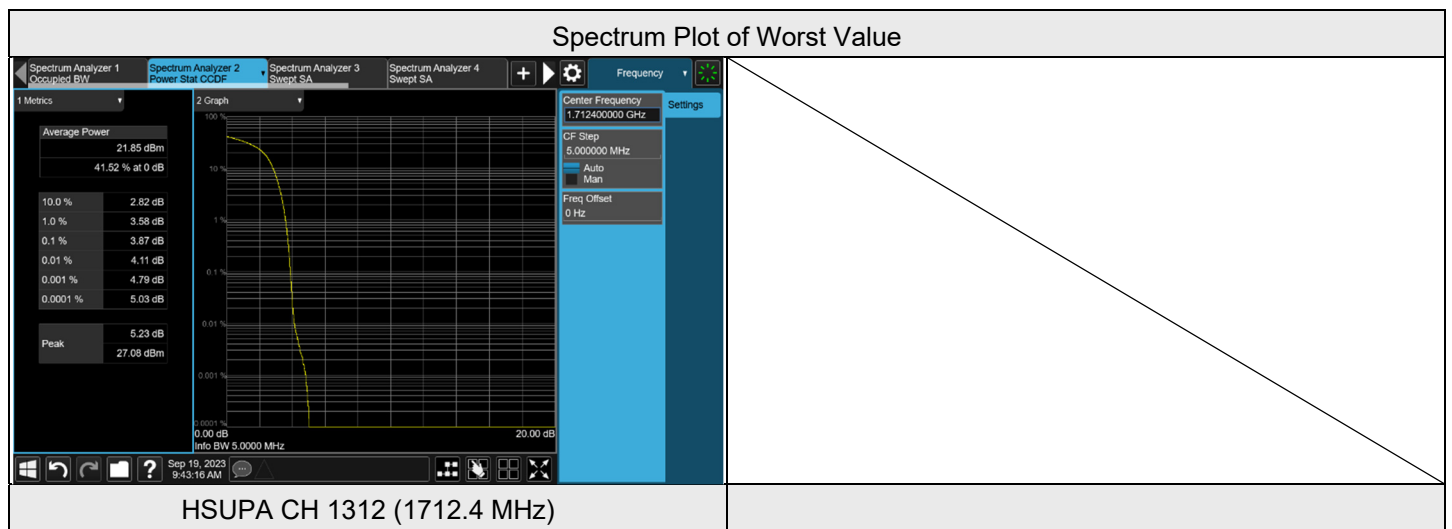

7.3.3 WCDMA Band 5

Modulation	Channel	Frequency (MHz)	Measurement Value(dB)	Limit (dB)	Result
WCDMA	4132	826.4	3.12	13	Pass
WCDMA	4182	836.4	2.91	13	Pass
WCDMA	4223	846.6	2.89	13	Pass
HSDPA	4132	826.4	3.73	13	Pass
HSDPA	4182	836.4	3.68	13	Pass
HSDPA	4223	846.6	3.77	13	Pass
HSUPA	4132	826.4	3.74	13	Pass
HSUPA	4182	836.4	3.67	13	Pass
HSUPA	4223	846.6	3.81	13	Pass

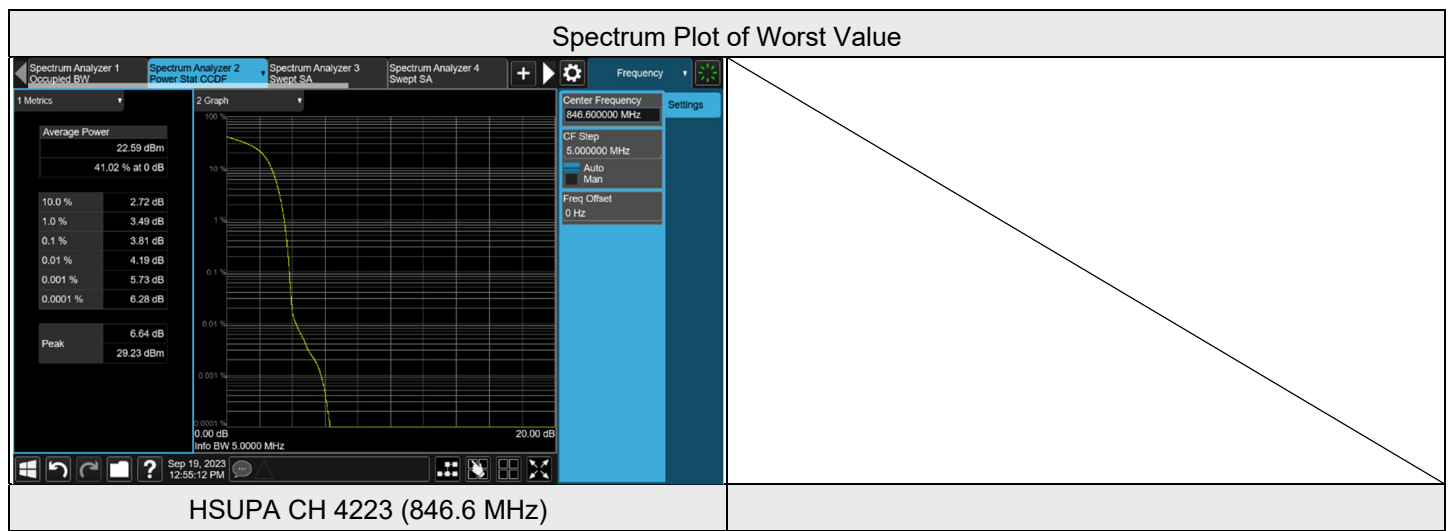

7.3.4 LTE Band 2

LTE Band 2, Channel Bandwidth: 1.4 MHz

Modulation	Channel	Frequency (MHz)	Measurement Value(dB)	Limit (dB)	Result
QPSK	18607	1850.7	5.07	13	Pass
QPSK	18900	1880	5.12	13	Pass
QPSK	19193	1909.3	4.87	13	Pass
16QAM	18607	1850.7	5.99	13	Pass
16QAM	18900	1880	6.10	13	Pass
16QAM	19193	1909.3	5.79	13	Pass

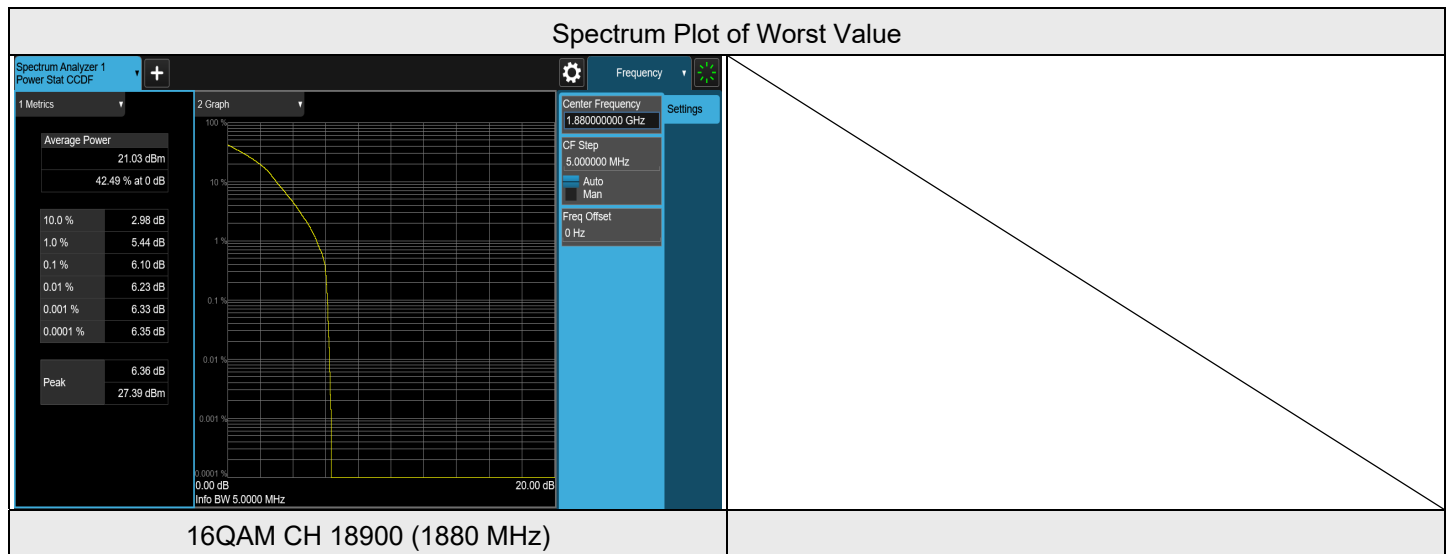

LTE Band 2, Channel Bandwidth: 3 MHz

Modulation	Channel	Frequency (MHz)	Measurement Value(dB)	Limit (dB)	Result
QPSK	18615	1851.5	5.05	13	Pass
QPSK	18900	1880	5.15	13	Pass
QPSK	19185	1908.5	5.01	13	Pass
16QAM	18615	1851.5	6.00	13	Pass
16QAM	18900	1880	6.10	13	Pass
16QAM	19185	1908.5	5.99	13	Pass

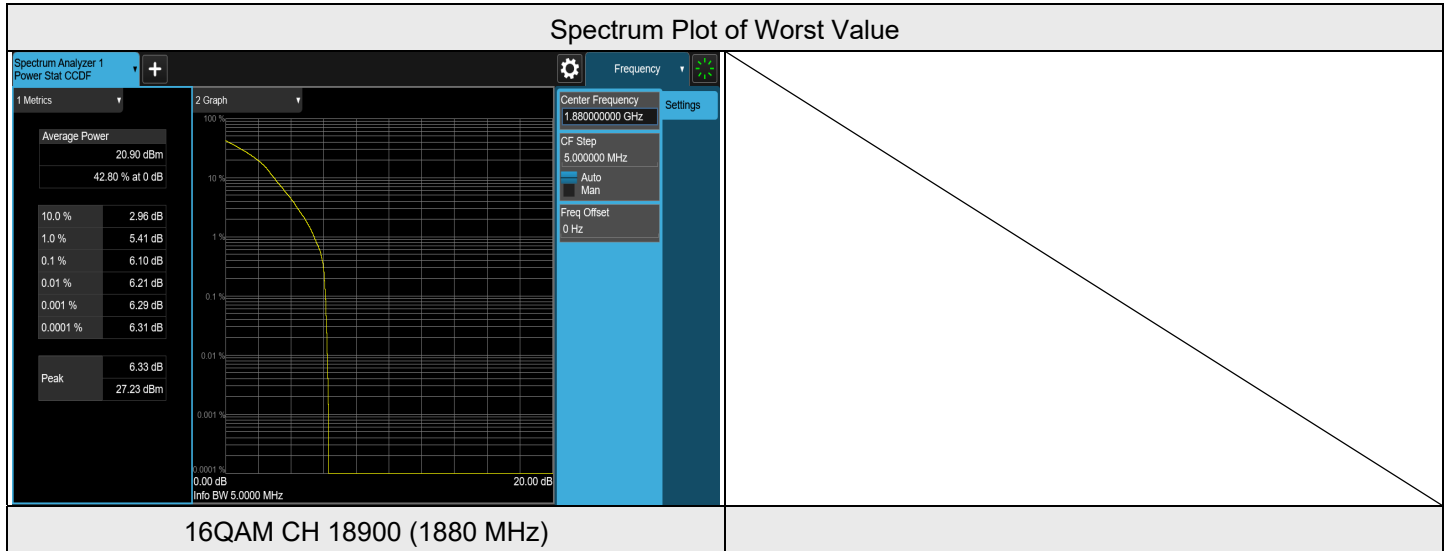



LTE Band 2, Channel Bandwidth: 5 MHz

Modulation	Channel	Frequency (MHz)	Measurement Value(dB)	Limit (dB)	Result
QPSK	18625	1852.5	4.99	13	Pass
QPSK	18900	1880	5.05	13	Pass
QPSK	19175	1907.5	5.00	13	Pass
16QAM	18625	1852.5	5.91	13	Pass
16QAM	18900	1880	6.00	13	Pass
16QAM	19175	1907.5	5.97	13	Pass

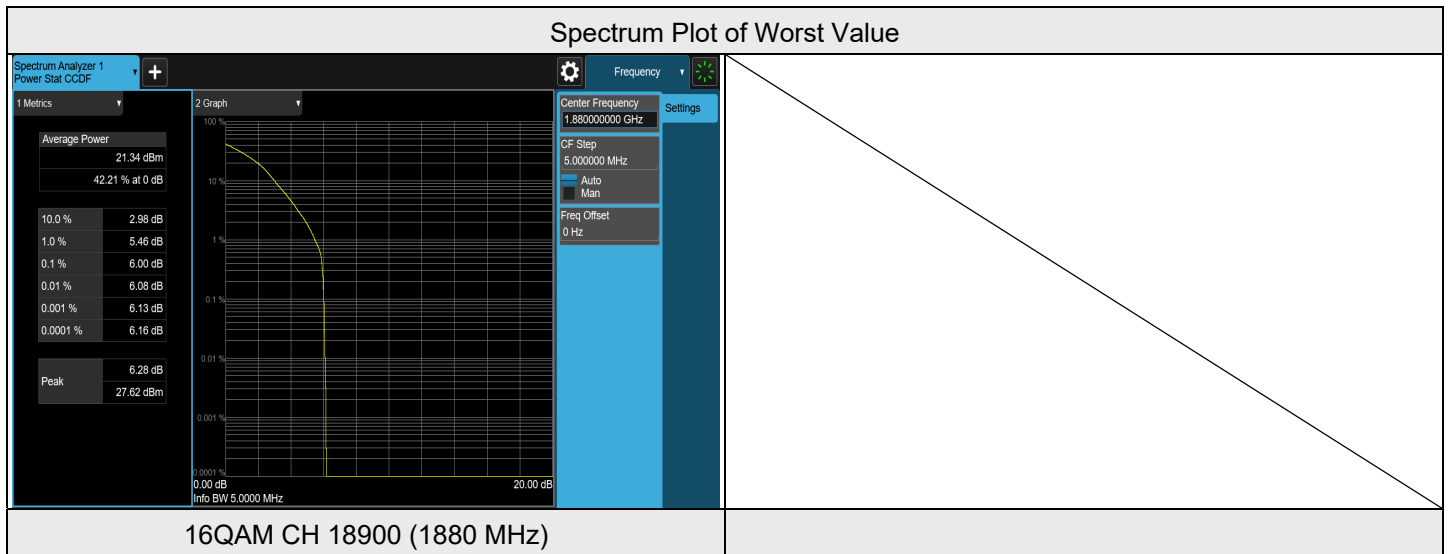

LTE Band 2, Channel Bandwidth: 10 MHz

Modulation	Channel	Frequency (MHz)	Measurement Value(dB)	Limit (dB)	Result
QPSK	18650	1855	5.00	13	Pass
QPSK	18900	1880	4.97	13	Pass
QPSK	19150	1905	4.84	13	Pass
16QAM	18650	1855	5.94	13	Pass
16QAM	18900	1880	5.92	13	Pass
16QAM	19150	1905	5.82	13	Pass

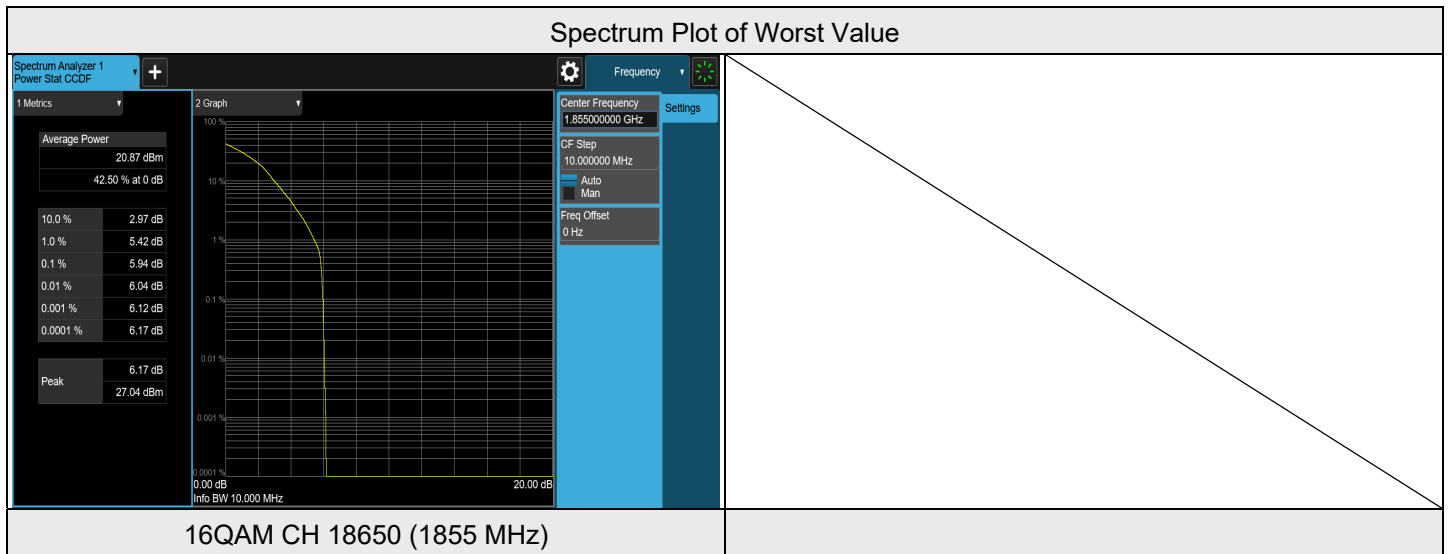

LTE Band 2, Channel Bandwidth: 15 MHz

Modulation	Channel	Frequency (MHz)	Measurement Value(dB)	Limit (dB)	Result
QPSK	18675	1857.5	5.03	13	Pass
QPSK	18900	1880	4.86	13	Pass
QPSK	19125	1902.5	4.78	13	Pass
16QAM	18675	1857.5	5.88	13	Pass
16QAM	18900	1880	5.81	13	Pass
16QAM	19125	1902.5	5.65	13	Pass

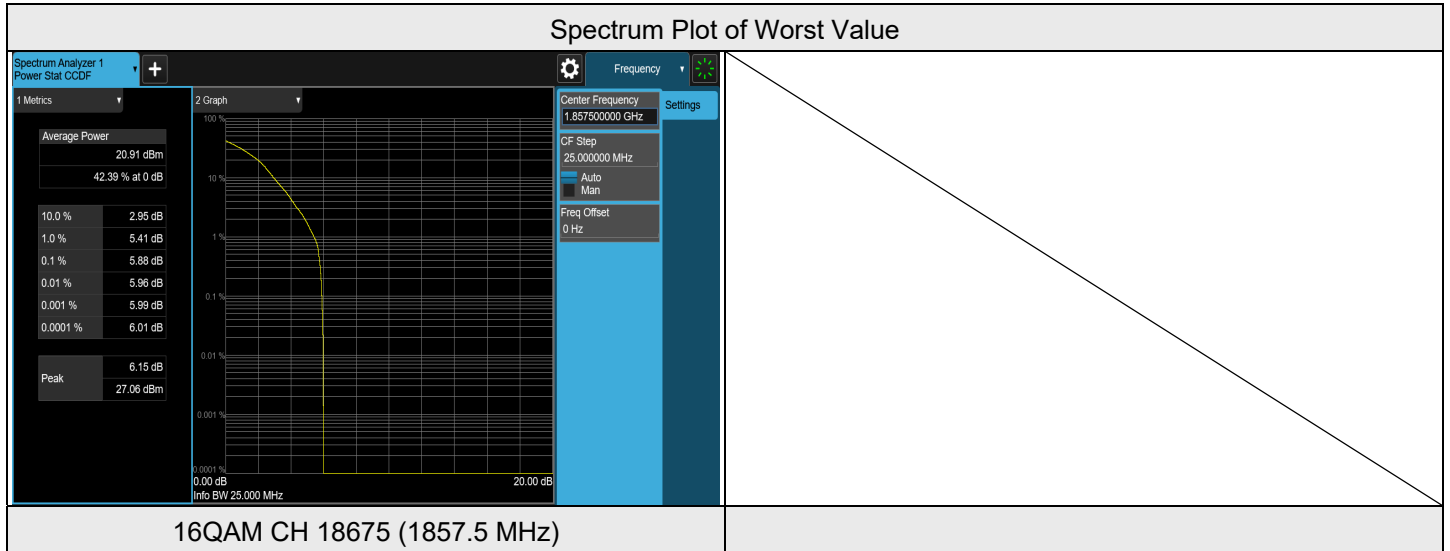

7.3.5 LTE Band 4

LTE Band 4, Channel Bandwidth: 1.4 MHz

Modulation	Channel	Frequency (MHz)	Measurement Value(dB)	Limit (dB)	Result
QPSK	19957	1710.7	4.99	13	Pass
QPSK	20175	1732.5	4.74	13	Pass
QPSK	20393	1754.3	4.34	13	Pass
16QAM	19957	1710.7	5.92	13	Pass
16QAM	20175	1732.5	5.70	13	Pass
16QAM	20393	1754.3	5.31	13	Pass

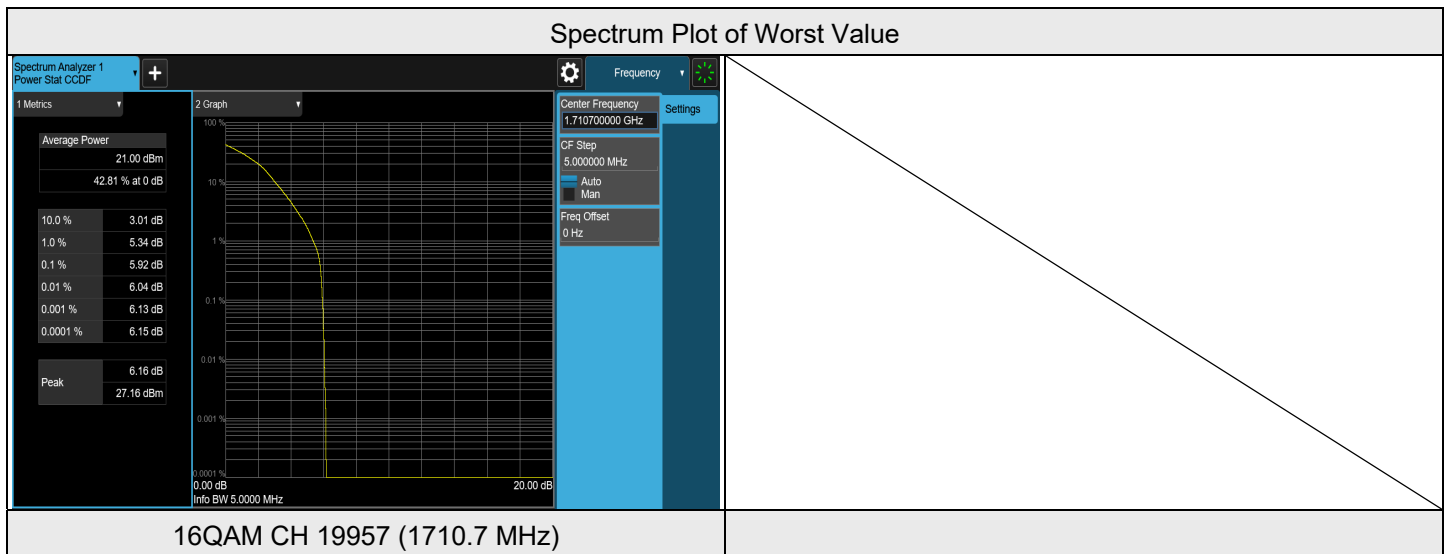

LTE Band 4, Channel Bandwidth: 5 MHz

Modulation	Channel	Frequency (MHz)	Measurement Value(dB)	Limit (dB)	Result
QPSK	19975	1712.5	4.94	13	Pass
QPSK	20175	1732.5	4.70	13	Pass
QPSK	20375	1752.5	4.46	13	Pass
16QAM	19975	1712.5	5.91	13	Pass
16QAM	20175	1732.5	5.68	13	Pass
16QAM	20375	1752.5	5.38	13	Pass

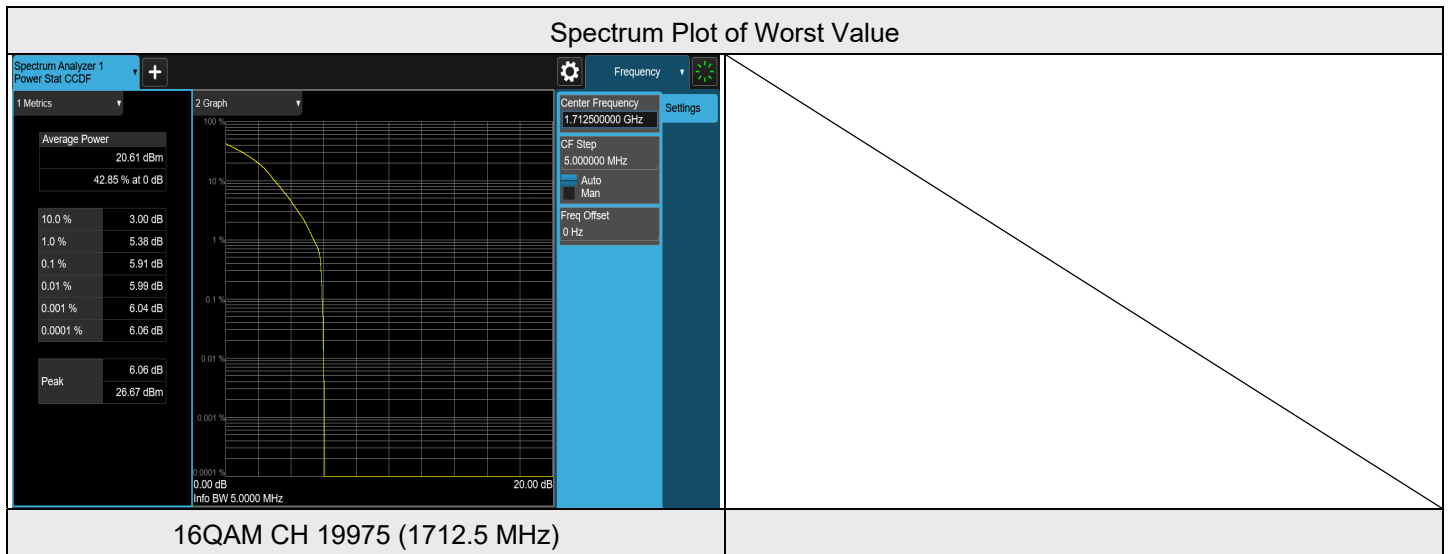

LTE Band 4, Channel Bandwidth: 10 MHz

Modulation	Channel	Frequency (MHz)	Measurement Value(dB)	Limit (dB)	Result
QPSK	20000	1715	4.93	13	Pass
QPSK	20175	1732.5	4.70	13	Pass
QPSK	20350	1750	4.65	13	Pass
16QAM	20000	1715	5.88	13	Pass
16QAM	20175	1732.5	5.66	13	Pass
16QAM	20350	1750	5.61	13	Pass

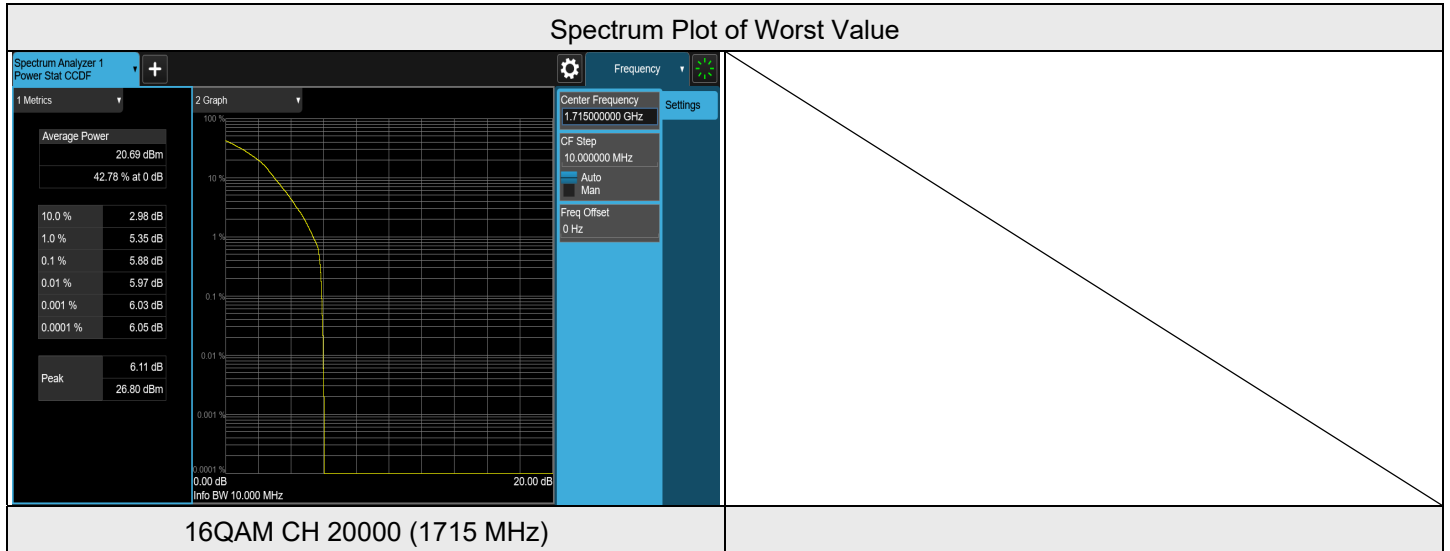

LTE Band 4, Channel Bandwidth: 15 MHz

Modulation	Channel	Frequency (MHz)	Measurement Value(dB)	Limit (dB)	Result
QPSK	20025	1717.5	4.94	13	Pass
QPSK	20175	1732.5	4.71	13	Pass
QPSK	20325	1747.5	4.71	13	Pass
16QAM	20025	1717.5	5.81	13	Pass
16QAM	20175	1732.5	5.73	13	Pass
16QAM	20325	1747.5	5.67	13	Pass

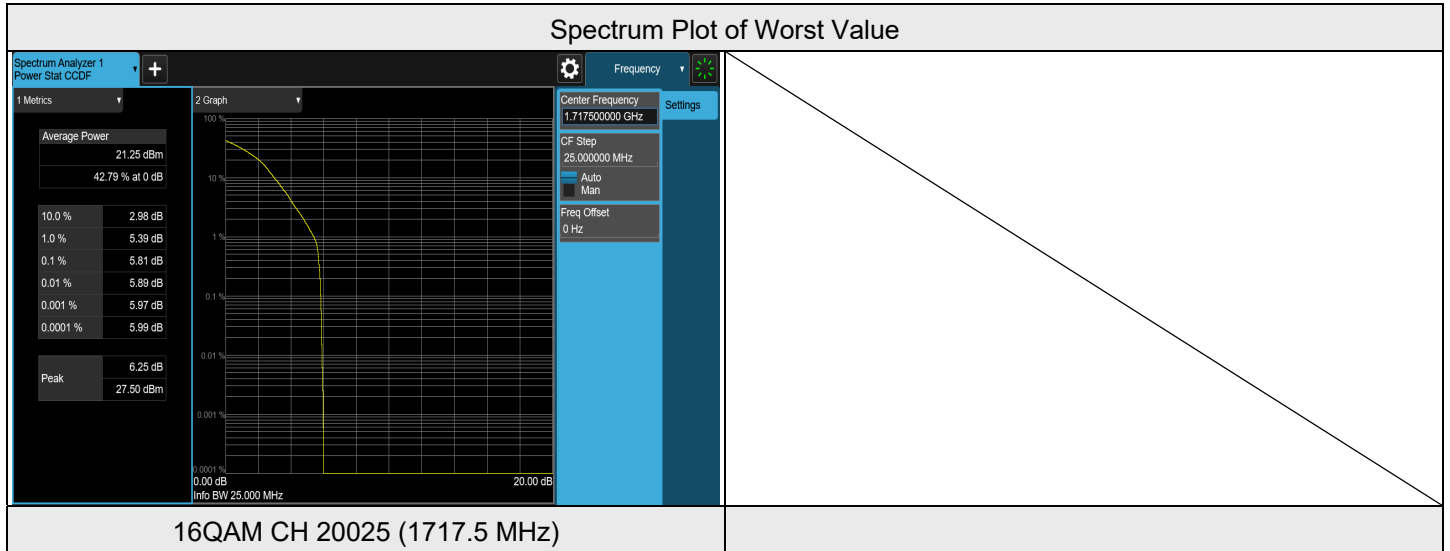

LTE Band 4, Channel Bandwidth: 20 MHz

Modulation	Channel	Frequency (MHz)	Measurement Value(dB)	Limit (dB)	Result
QPSK	20050	1720	4.90	13	Pass
QPSK	20175	1732.5	4.73	13	Pass
QPSK	20300	1745	4.80	13	Pass
16QAM	20050	1720	5.88	13	Pass
16QAM	20175	1732.5	5.81	13	Pass
16QAM	20300	1745	5.68	13	Pass

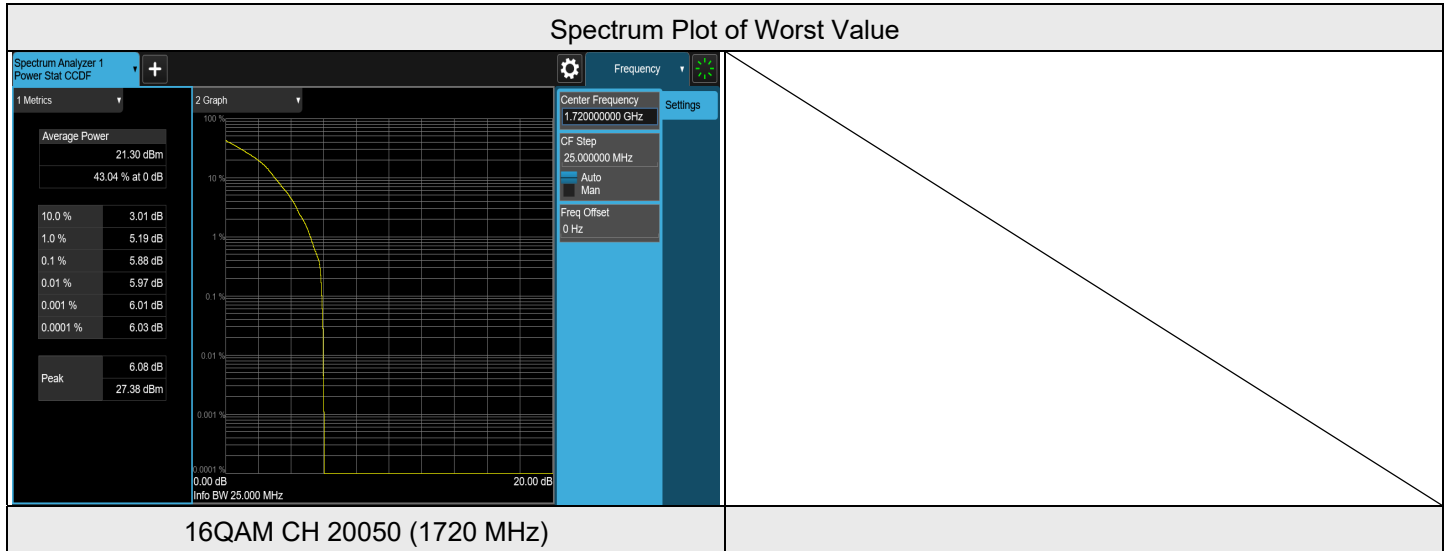

7.3.6 LTE Band 5

LTE Band 5, Channel Bandwidth: 1.4 MHz

Modulation	Channel	Frequency (MHz)	Measurement Value(dB)	Limit (dB)	Result
QPSK	20407	824.7	4.89	13	Pass
QPSK	20525	836.5	4.41	13	Pass
QPSK	20643	848.3	4.05	13	Pass
16QAM	20407	824.7	5.83	13	Pass
16QAM	20525	836.5	5.37	13	Pass
16QAM	20643	848.3	4.95	13	Pass

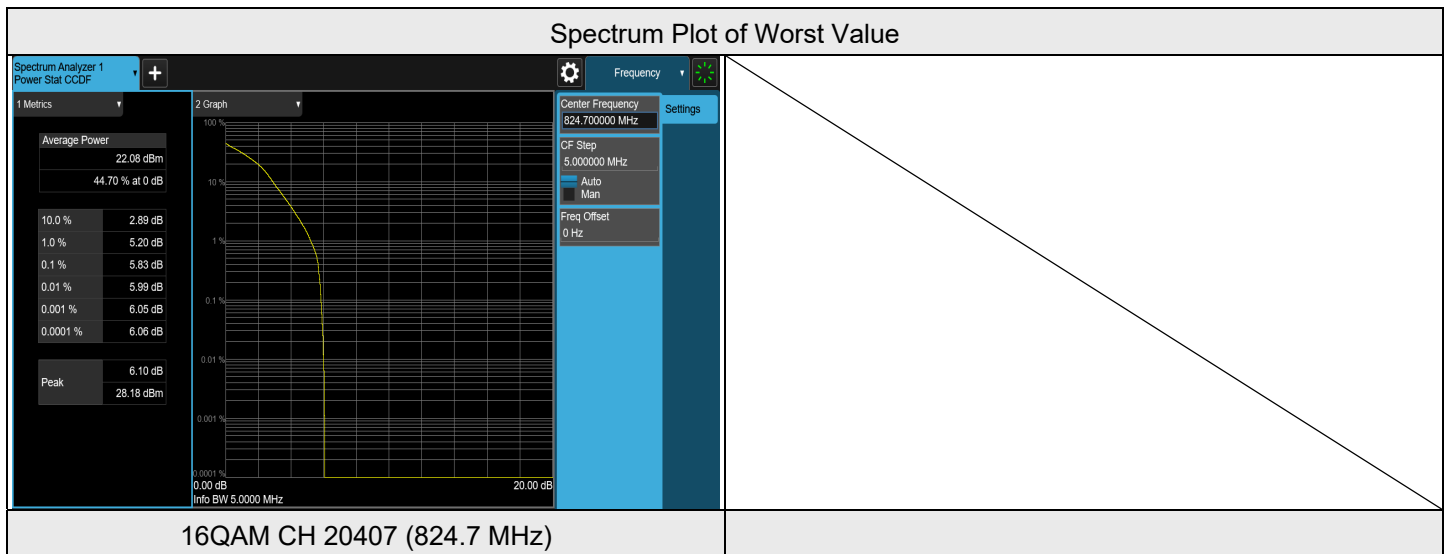

LTE Band 5, Channel Bandwidth: 5 MHz

Modulation	Channel	Frequency (MHz)	Measurement Value(dB)	Limit (dB)	Result
QPSK	20425	826.5	4.78	13	Pass
QPSK	20525	836.5	4.33	13	Pass
QPSK	20625	846.5	4.29	13	Pass
16QAM	20425	826.5	5.90	13	Pass
16QAM	20525	836.5	5.33	13	Pass
16QAM	20625	846.5	5.28	13	Pass

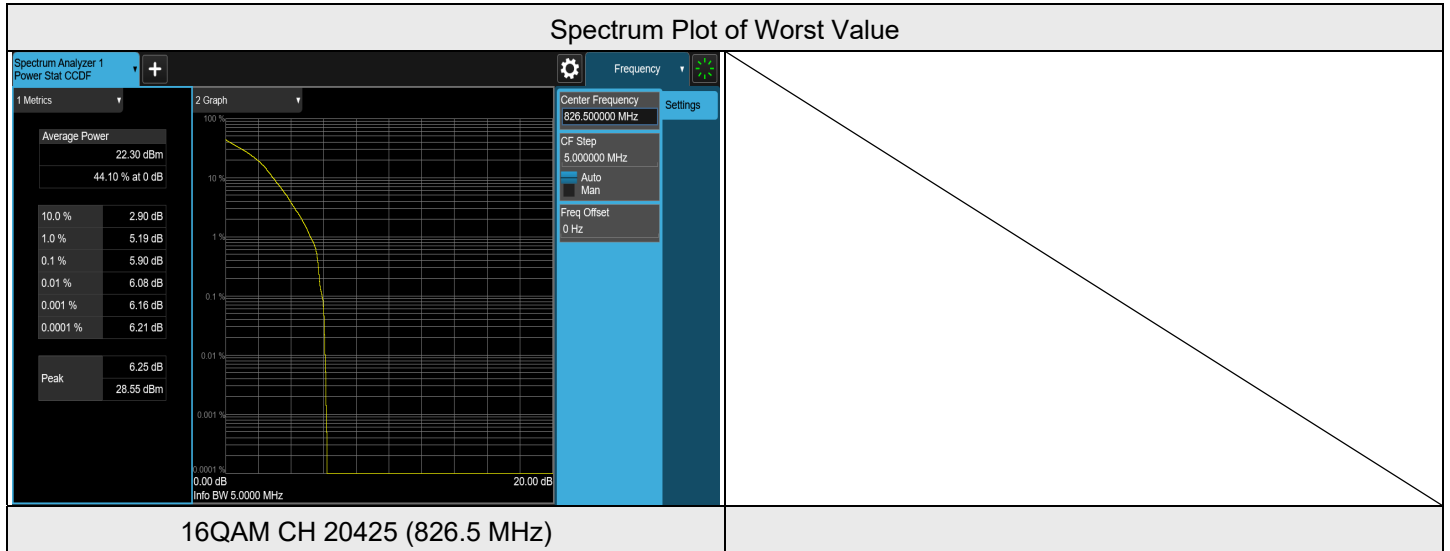



LTE Band 5, Channel Bandwidth: 10 MHz

Modulation	Channel	Frequency (MHz)	Measurement Value(dB)	Limit (dB)	Result
QPSK	20450	829	4.43	13	Pass
QPSK	20525	836.5	4.35	13	Pass
QPSK	20600	844	4.34	13	Pass
16QAM	20450	829	5.33	13	Pass
16QAM	20525	836.5	5.27	13	Pass
16QAM	20600	844	5.31	13	Pass

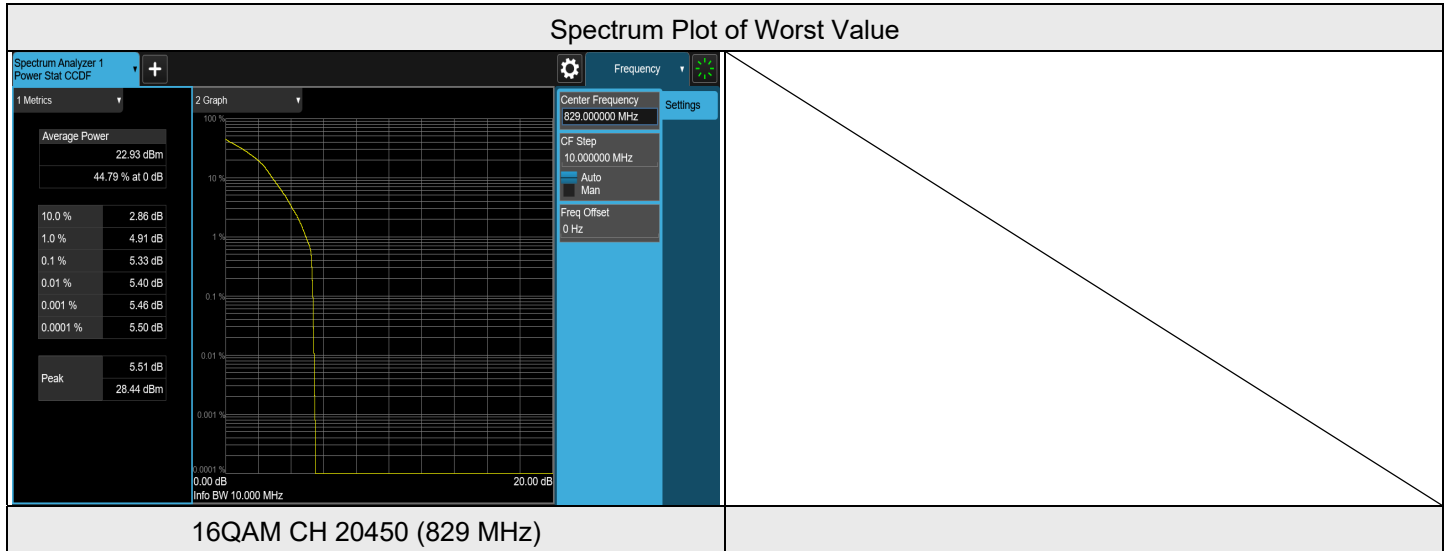

7.3.7 LTE Band 12

LTE Band 12, Channel Bandwidth: 1.4 MHz

Modulation	Channel	Frequency (MHz)	Measurement Value(dB)	Limit (dB)	Result
QPSK	23017	699.7	4.33	13	Pass
QPSK	23095	707.5	4.21	13	Pass
QPSK	23173	715.3	4.20	13	Pass
16QAM	23017	699.7	5.28	13	Pass
16QAM	23095	707.5	5.14	13	Pass
16QAM	23173	715.3	5.12	13	Pass

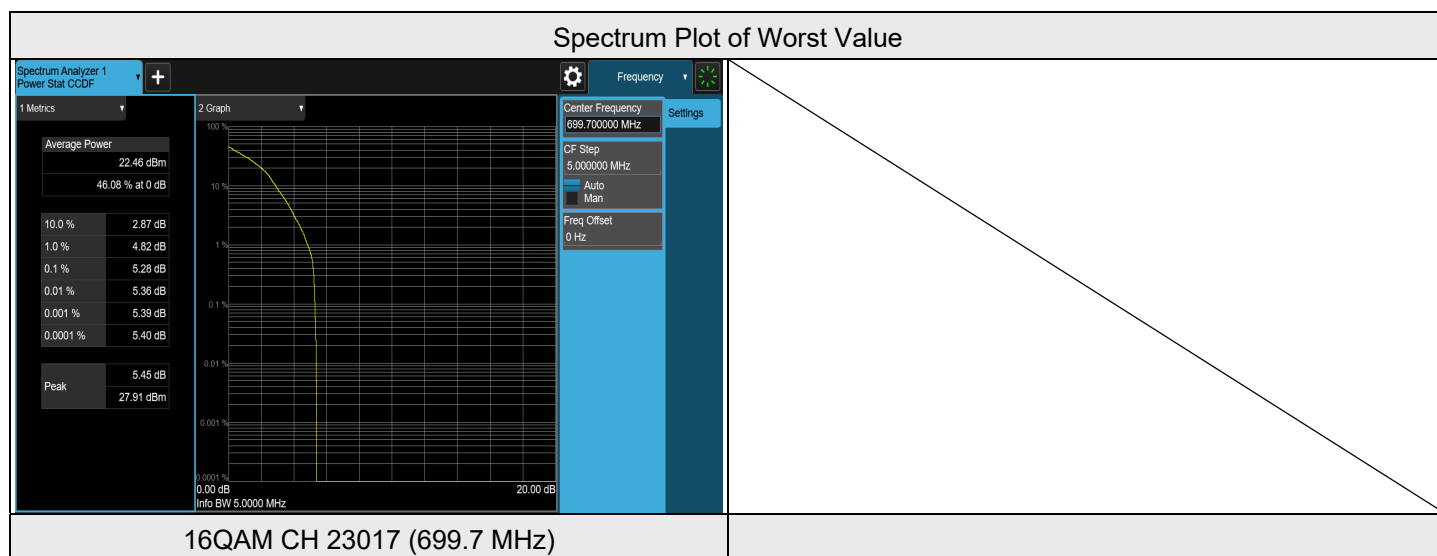



LTE Band 12, Channel Bandwidth: 3 MHz

Modulation	Channel	Frequency (MHz)	Measurement Value(dB)	Limit (dB)	Result
QPSK	23025	700.5	4.35	13	Pass
QPSK	23095	707.5	4.26	13	Pass
QPSK	23165	714.5	4.26	13	Pass
16QAM	23025	700.5	5.31	13	Pass
16QAM	23095	707.5	5.25	13	Pass
16QAM	23165	714.5	5.26	13	Pass

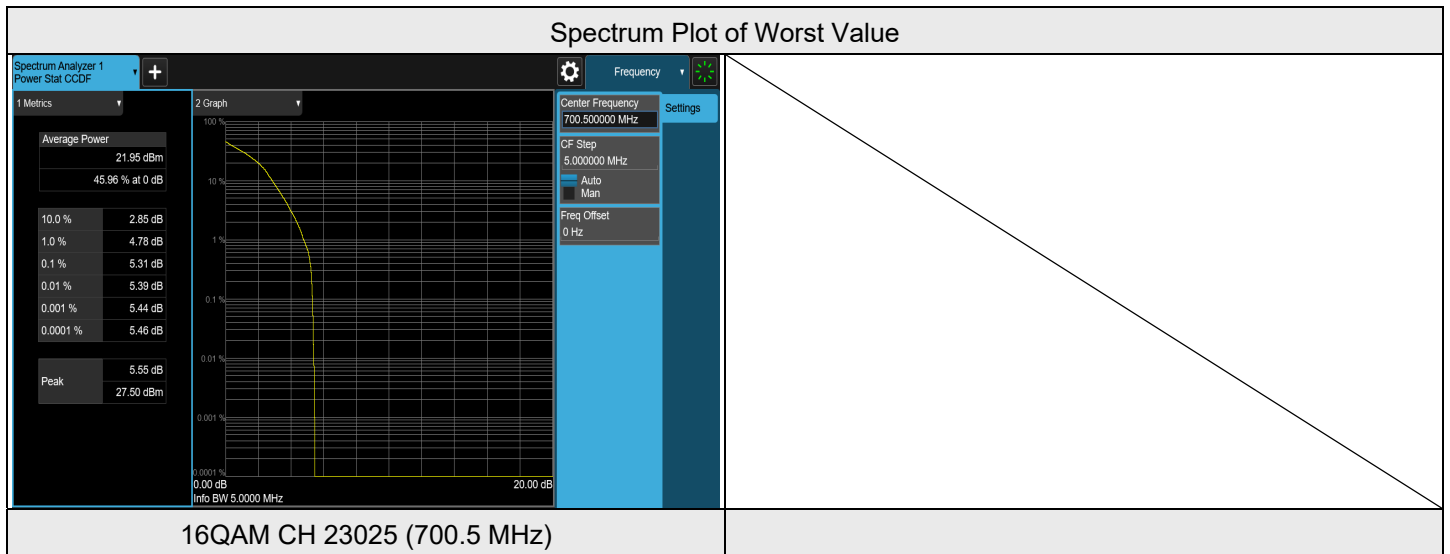



LTE Band 12, Channel Bandwidth: 5 MHz

Modulation	Channel	Frequency (MHz)	Measurement Value(dB)	Limit (dB)	Result
QPSK	23035	701.5	4.39	13	Pass
QPSK	23095	707.5	4.25	13	Pass
QPSK	23155	713.5	4.17	13	Pass
16QAM	23035	701.5	5.28	13	Pass
16QAM	23095	707.5	5.31	13	Pass
16QAM	23155	713.5	5.19	13	Pass

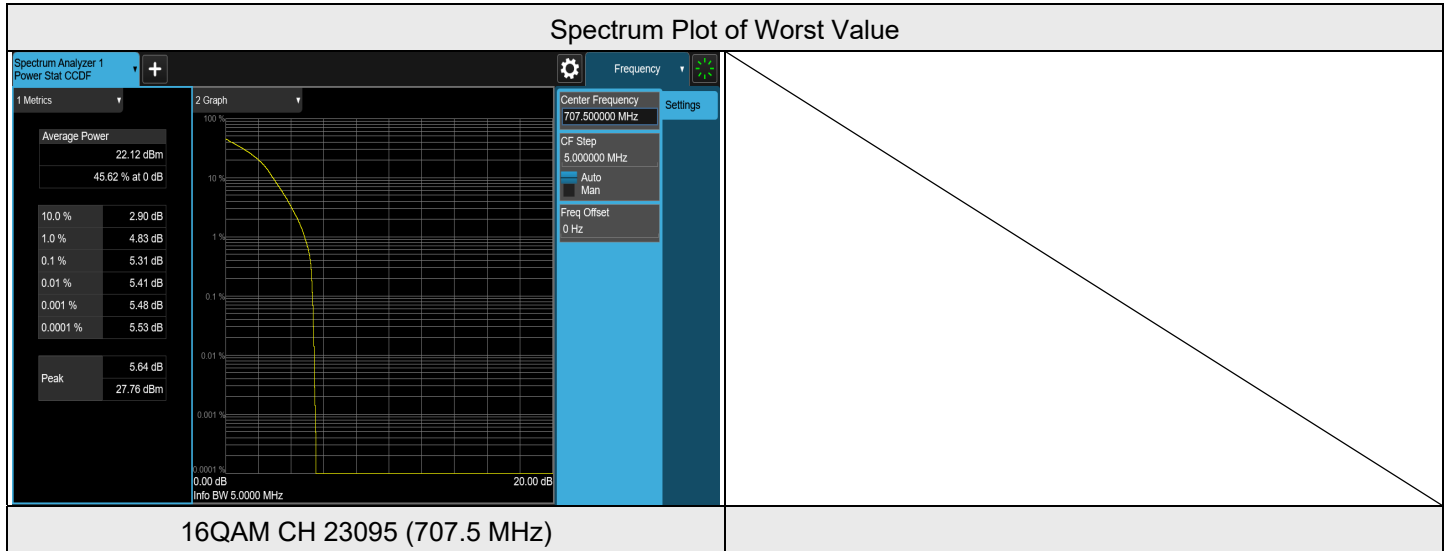

LTE Band 12, Channel Bandwidth: 10 MHz

Modulation	Channel	Frequency (MHz)	Measurement Value(dB)	Limit (dB)	Result
QPSK	23060	704	4.13	13	Pass
QPSK	23095	707.5	4.45	13	Pass
QPSK	23130	711	4.24	13	Pass
16QAM	23060	704	5.08	13	Pass
16QAM	23095	707.5	5.41	13	Pass
16QAM	23130	711	5.23	13	Pass

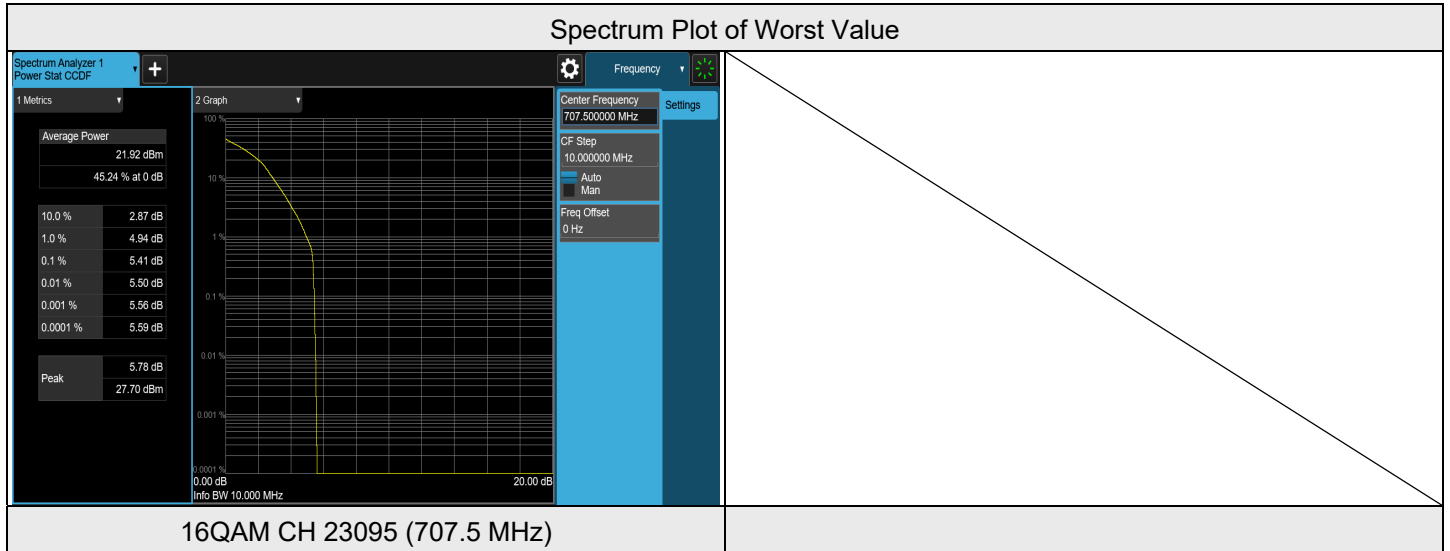

7.3.8 LTE Band 25

LTE Band 25, Channel Bandwidth: 1.4 MHz

Modulation	Channel	Frequency (MHz)	Measurement Value(dB)	Limit (dB)	Result
QPSK	26047	1850.7	5.04	13	Pass
QPSK	26365	1882.5	5.16	13	Pass
QPSK	26683	1914.3	4.43	13	Pass
16QAM	26047	1850.7	6.01	13	Pass
16QAM	26365	1882.5	6.13	13	Pass
16QAM	26683	1914.3	5.42	13	Pass

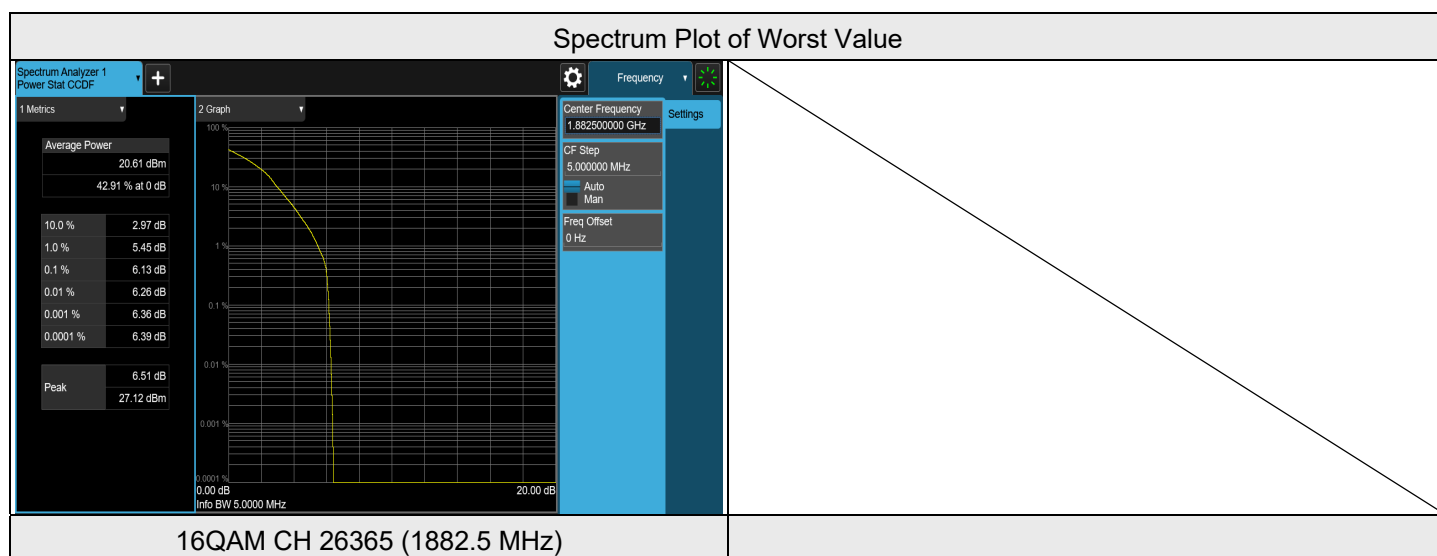



LTE Band 25, Channel Bandwidth: 5 MHz

Modulation	Channel	Frequency (MHz)	Measurement Value(dB)	Limit (dB)	Result
QPSK	26065	1852.5	5.01	13	Pass
QPSK	26365	1882.5	5.09	13	Pass
QPSK	26665	1912.5	4.76	13	Pass
16QAM	26065	1852.5	5.96	13	Pass
16QAM	26365	1882.5	6.07	13	Pass
16QAM	26665	1912.5	5.74	13	Pass

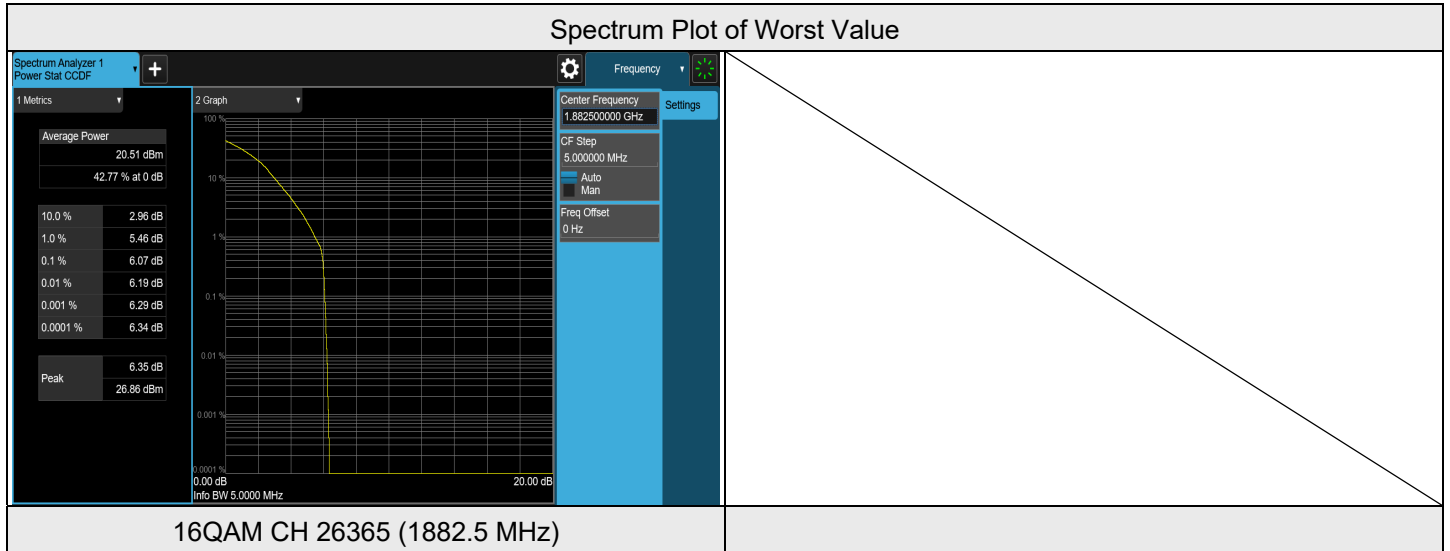



LTE Band 25, Channel Bandwidth: 10 MHz

Modulation	Channel	Frequency (MHz)	Measurement Value(dB)	Limit (dB)	Result
QPSK	26090	1855	5.04	13	Pass
QPSK	26365	1882.5	5.05	13	Pass
QPSK	26640	1910	5.01	13	Pass
16QAM	26090	1855	6.00	13	Pass
16QAM	26365	1882.5	5.93	13	Pass
16QAM	26640	1910	5.95	13	Pass

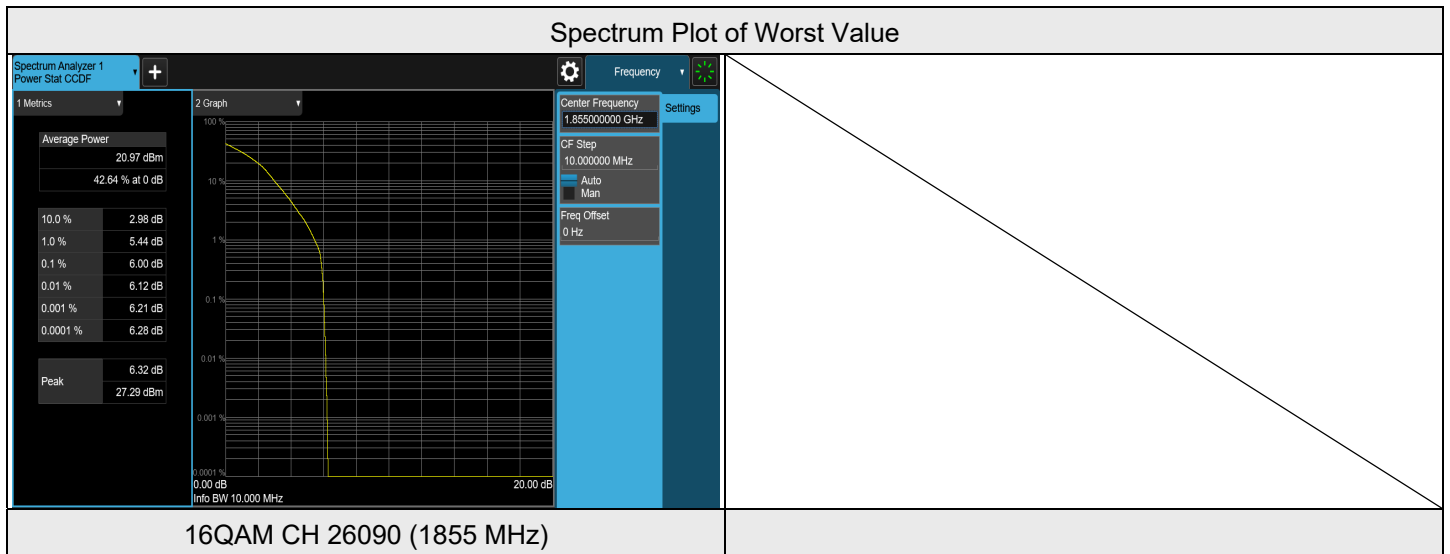



LTE Band 25, Channel Bandwidth: 15 MHz

Modulation	Channel	Frequency (MHz)	Measurement Value(dB)	Limit (dB)	Result
QPSK	26115	1857.5	5.05	13	Pass
QPSK	26365	1882.5	4.98	13	Pass
QPSK	26615	1907.5	4.86	13	Pass
16QAM	26115	1857.5	5.98	13	Pass
16QAM	26365	1882.5	5.95	13	Pass
16QAM	26615	1907.5	5.62	13	Pass

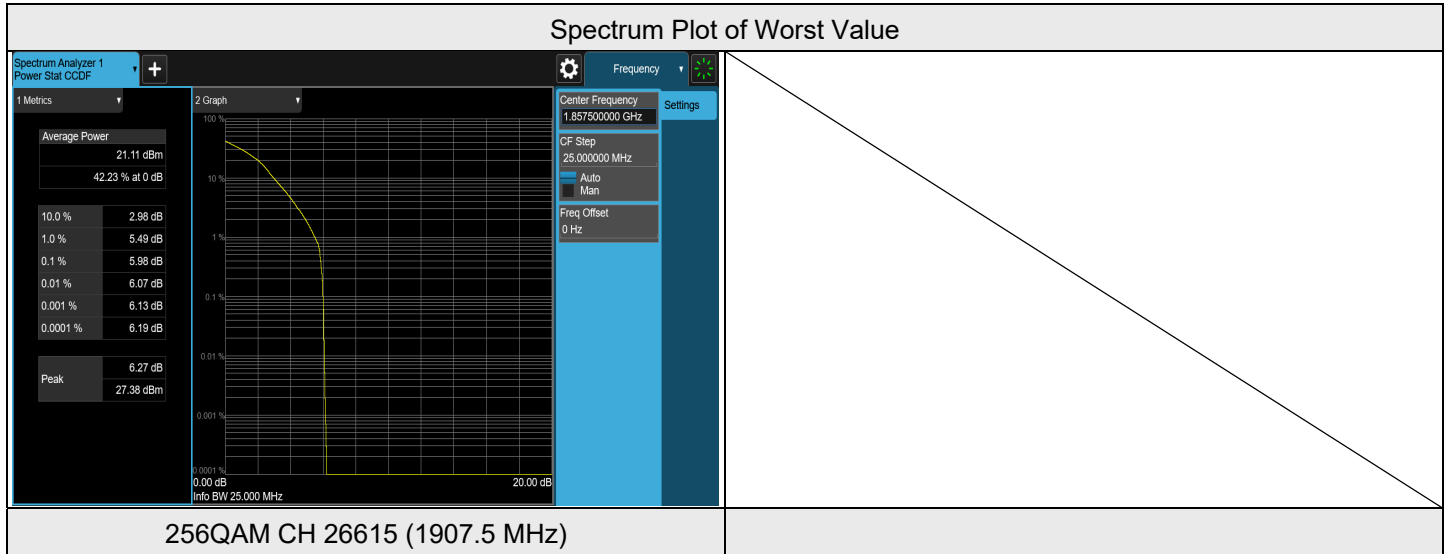

LTE Band 25, Channel Bandwidth: 20 MHz

Modulation	Channel	Frequency (MHz)	Measurement Value(dB)	Limit (dB)	Result
QPSK	26140	1860	5.02	13	Pass
QPSK	26365	1882.5	4.85	13	Pass
QPSK	26590	1905	4.75	13	Pass
16QAM	26140	1860	5.90	13	Pass
16QAM	26365	1882.5	5.66	13	Pass
16QAM	26590	1905	5.77	13	Pass

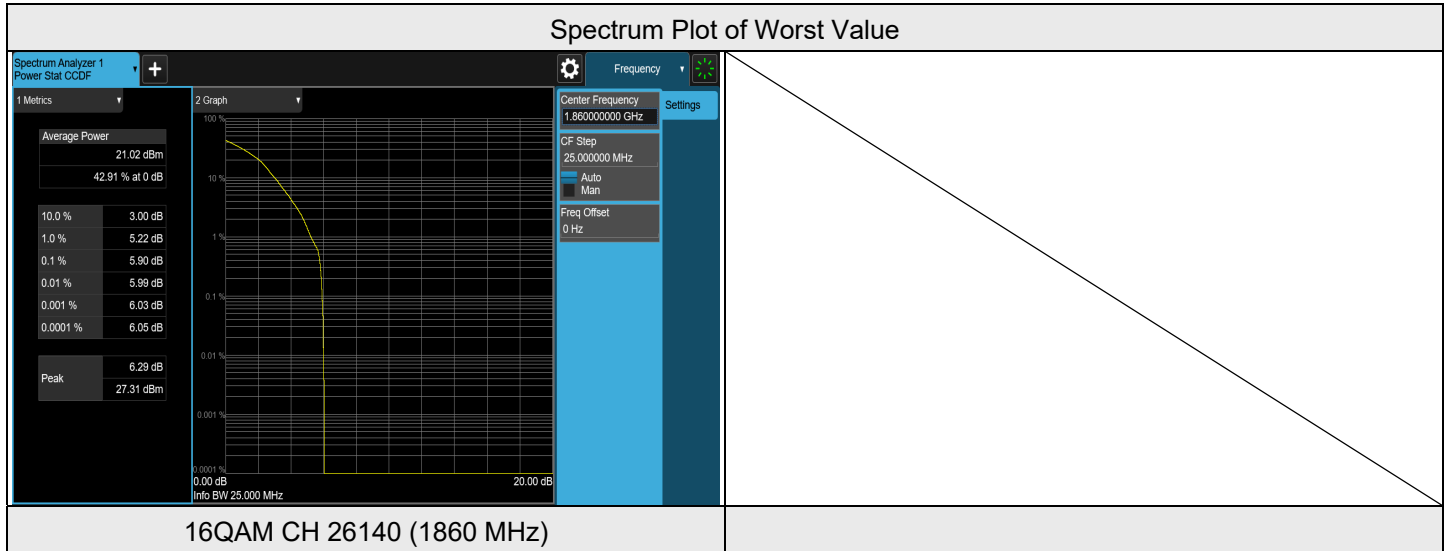

7.3.9 LTE Band 26 (824 MHz ~ 849 MHz)

LTE Band 26 (824 MHz ~ 849 MHz), Channel Bandwidth: 1.4 MHz

Modulation	Channel	Frequency (MHz)	Measurement Value(dB)	Limit (dB)	Result
QPSK	26797	824.7	4.83	13	Pass
QPSK	26915	836.5	4.44	13	Pass
QPSK	27033	848.3	4.03	13	Pass
16QAM	26797	824.7	5.72	13	Pass
16QAM	26915	836.5	5.44	13	Pass
16QAM	27033	848.3	4.96	13	Pass

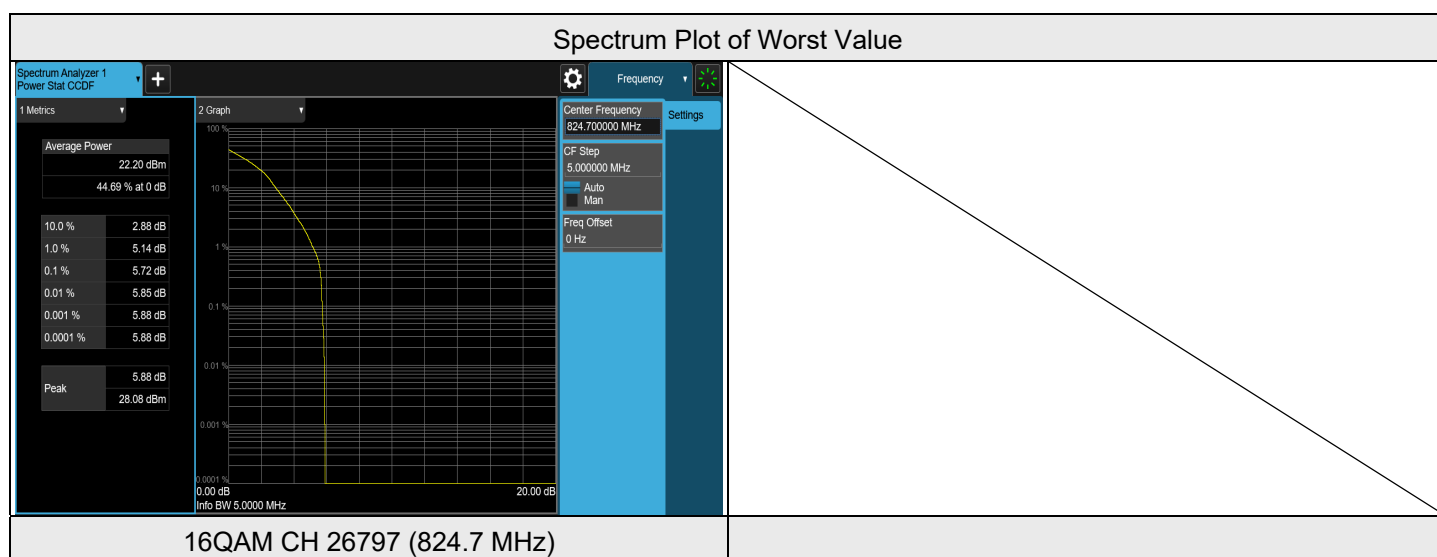

LTE Band 26 (824 MHz ~ 849 MHz), Channel Bandwidth: 3 MHz

Modulation	Channel	Frequency (MHz)	Measurement Value(dB)	Limit (dB)	Result
QPSK	26805	825.5	4.84	13	Pass
QPSK	26915	836.5	4.41	13	Pass
QPSK	27025	847.5	4.06	13	Pass
16QAM	26805	825.5	5.73	13	Pass
16QAM	26915	836.5	5.28	13	Pass
16QAM	27025	847.5	5.07	13	Pass

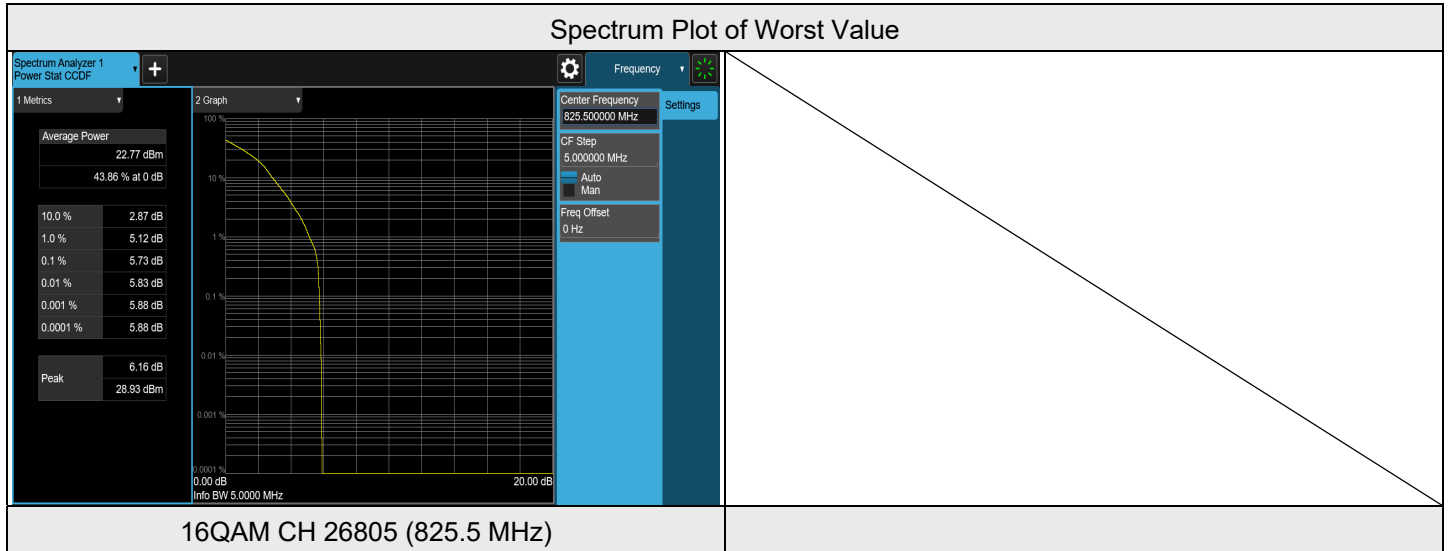

LTE Band 26 (824 MHz ~ 849 MHz), Channel Bandwidth: 5 MHz

Modulation	Channel	Frequency (MHz)	Measurement Value(dB)	Limit (dB)	Result
QPSK	26815	826.5	4.75	13	Pass
QPSK	26915	836.5	4.35	13	Pass
QPSK	27015	846.5	4.29	13	Pass
16QAM	26815	826.5	5.68	13	Pass
16QAM	26915	836.5	5.22	13	Pass
16QAM	27015	846.5	5.24	13	Pass

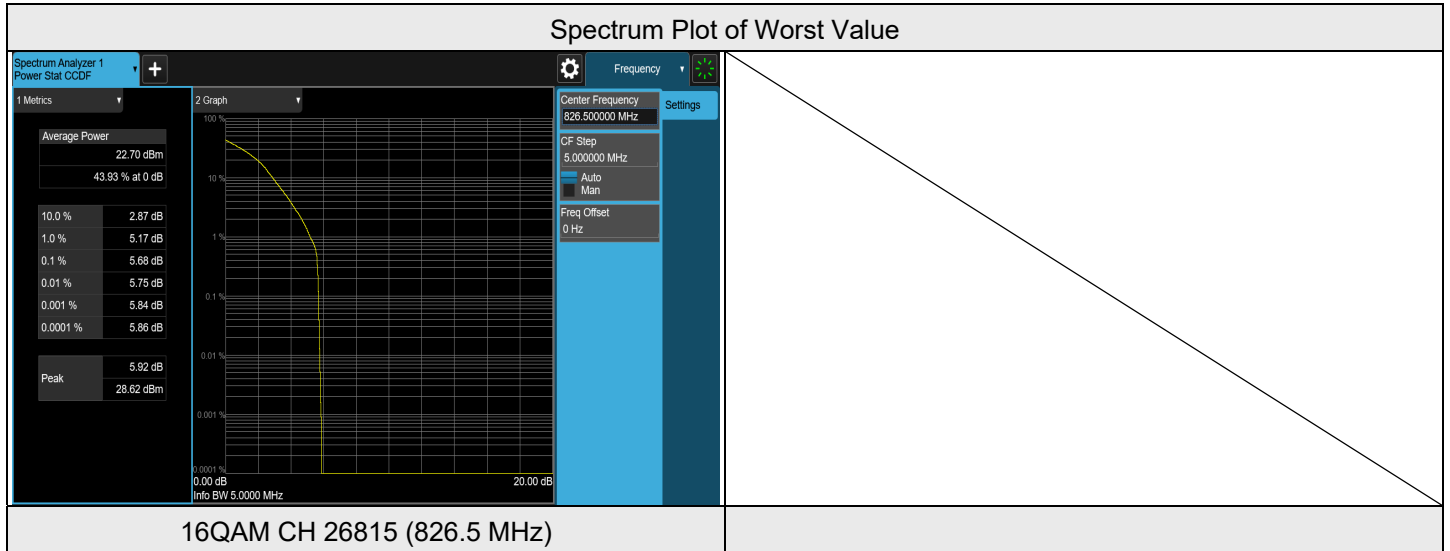



LTE Band 26 (824 MHz ~ 849 MHz), Channel Bandwidth: 10 MHz

Modulation	Channel	Frequency (MHz)	Measurement Value(dB)	Limit (dB)	Result
QPSK	26840	829	4.77	13	Pass
QPSK	26915	836.5	4.38	13	Pass
QPSK	26990	844	4.34	13	Pass
16QAM	26840	829	5.65	13	Pass
16QAM	26915	836.5	5.31	13	Pass
16QAM	26990	844	5.33	13	Pass

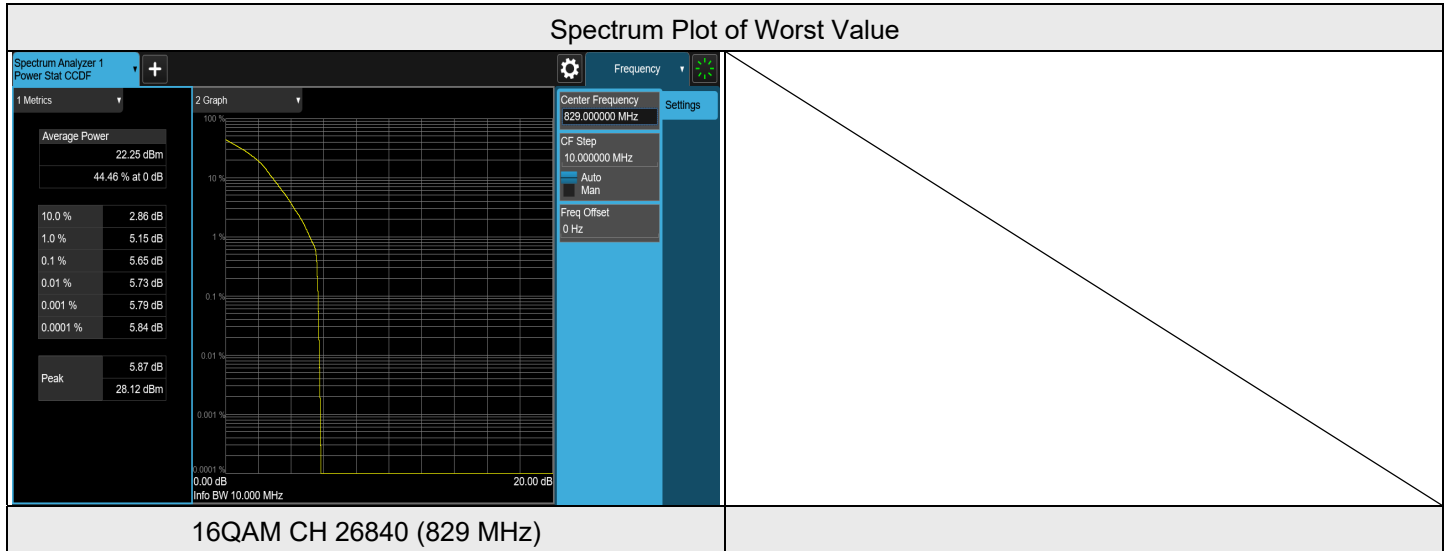

LTE Band 26 (824 MHz ~ 849 MHz), Channel Bandwidth: 15 MHz

Modulation	Channel	Frequency (MHz)	Measurement Value(dB)	Limit (dB)	Result
QPSK	26865	831.5	4.40	13	Pass
QPSK	26915	836.5	4.68	13	Pass
QPSK	26965	841.5	4.31	13	Pass
16QAM	26865	831.5	5.37	13	Pass
16QAM	26915	836.5	5.62	13	Pass
16QAM	26965	841.5	5.26	13	Pass

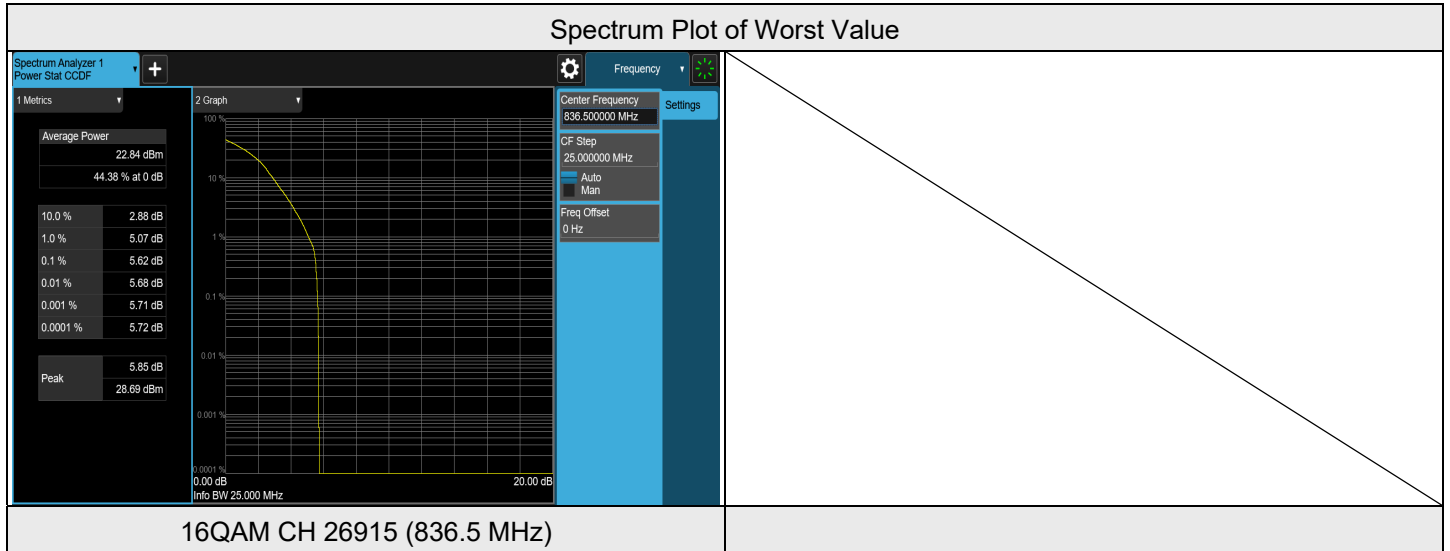

7.4 Bandwidth

Input Power:	3.6 Vdc	Environmental Conditions:	21°C, 70% RH	Tested By:	Willy Cheng
--------------	---------	---------------------------	--------------	------------	-------------

7.4.1 WCDMA Band 2

Modulation	Channel	Frequency (MHz)	Occupied Bandwidth (MHz)	26 dB Bandwidth (MHz)
WCDMA	9262	1852.4	4.1344	4.702
WCDMA	9400	1880	4.1369	4.703
WCDMA	9538	1907.6	4.1341	4.715
HSDPA	9262	1852.4	4.1408	4.694
HSDPA	9400	1880	4.1413	4.685
HSDPA	9538	1907.6	4.1372	4.695
HSUPA	9262	1852.4	4.1369	4.701
HSUPA	9400	1880	4.1357	4.700
HSUPA	9538	1907.6	4.1304	4.698

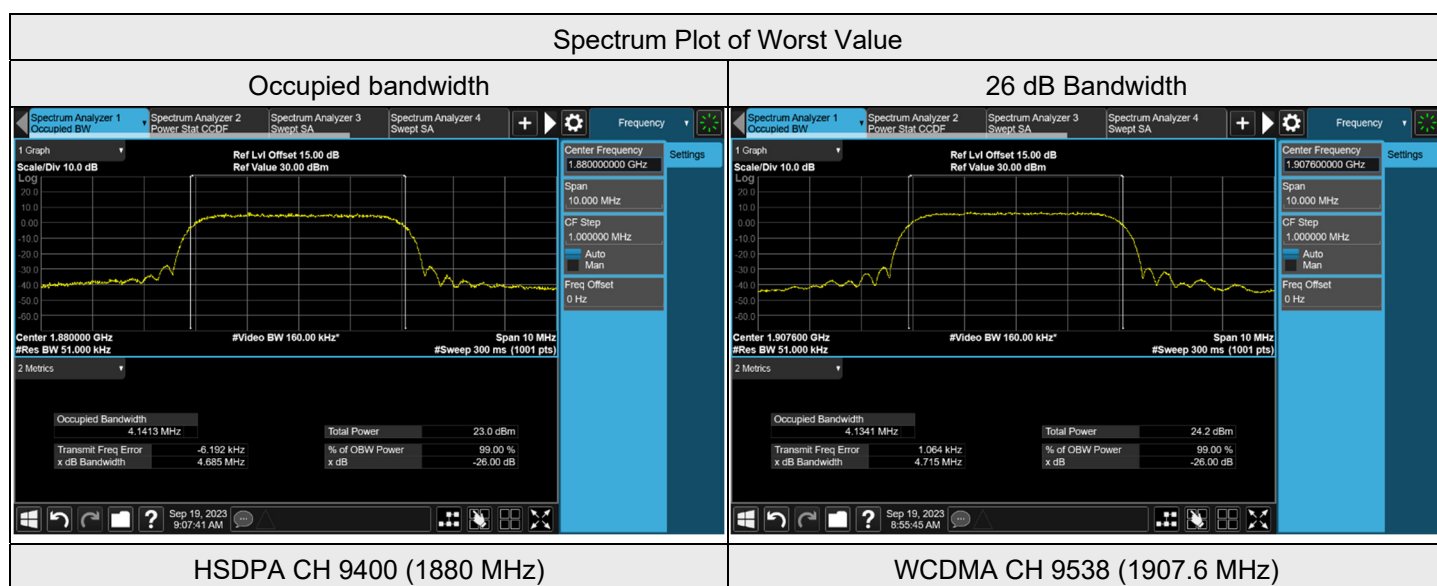

7.4.2 WCDMA Band 4

Modulation	Channel	Frequency (MHz)	Occupied Bandwidth (MHz)	26 dB Bandwidth (MHz)
WCDMA	1312	1712.4	4.1361	4.699
WCDMA	1413	1732.6	4.1361	4.696
WCDMA	1513	1752.6	4.1336	4.720
HSDPA	1312	1712.4	4.1417	4.686
HSDPA	1413	1732.6	4.1384	4.669
HSDPA	1513	1752.6	4.1337	4.696
HSUPA	1312	1712.4	4.1306	4.684
HSUPA	1413	1732.6	4.1264	4.688
HSUPA	1513	1752.6	4.1236	4.694

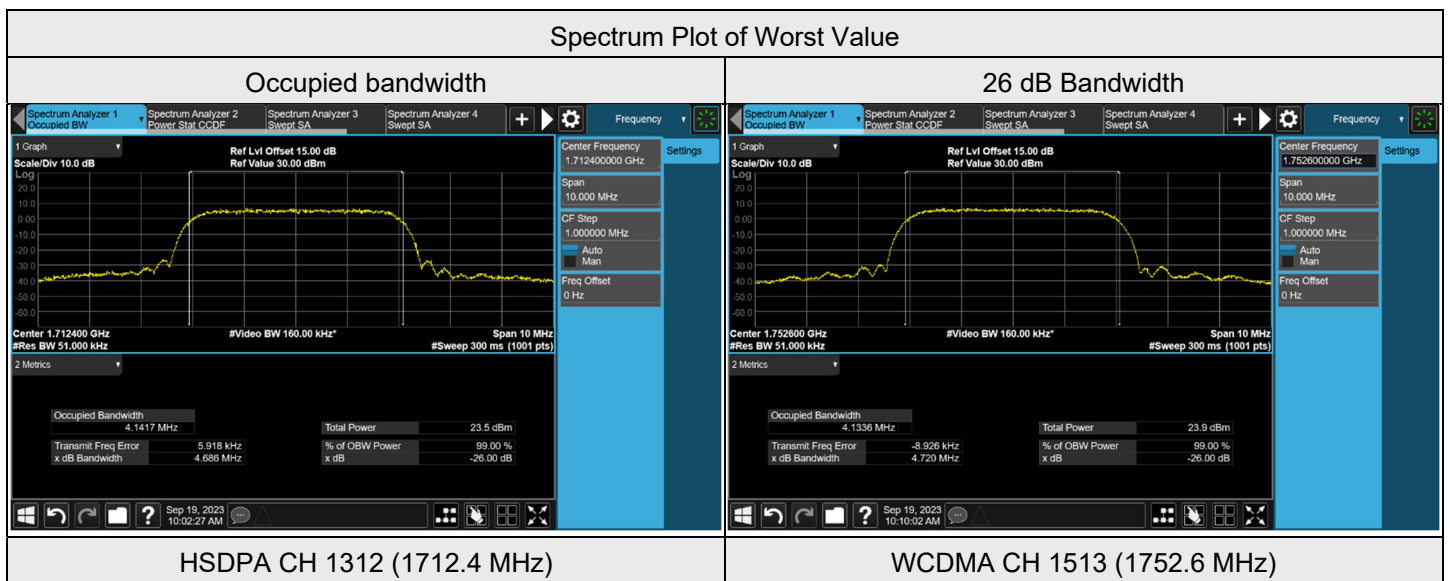

7.4.3 WCDMA Band 5

Modulation	Channel	Frequency (MHz)	Occupied Bandwidth (MHz)	26 dB Bandwidth (MHz)
WCDMA	4132	826.4	4.1358	4.700
WCDMA	4182	836.4	4.1611	4.717
WCDMA	4223	846.6	4.1586	4.721
HSDPA	4132	826.4	4.1409	4.691
HSDPA	4182	836.4	4.1483	4.714
HSDPA	4223	846.6	4.1313	4.681
HSUPA	4132	826.4	4.1391	4.704
HSUPA	4182	836.4	4.1592	4.709
HSUPA	4223	846.6	4.1313	4.698

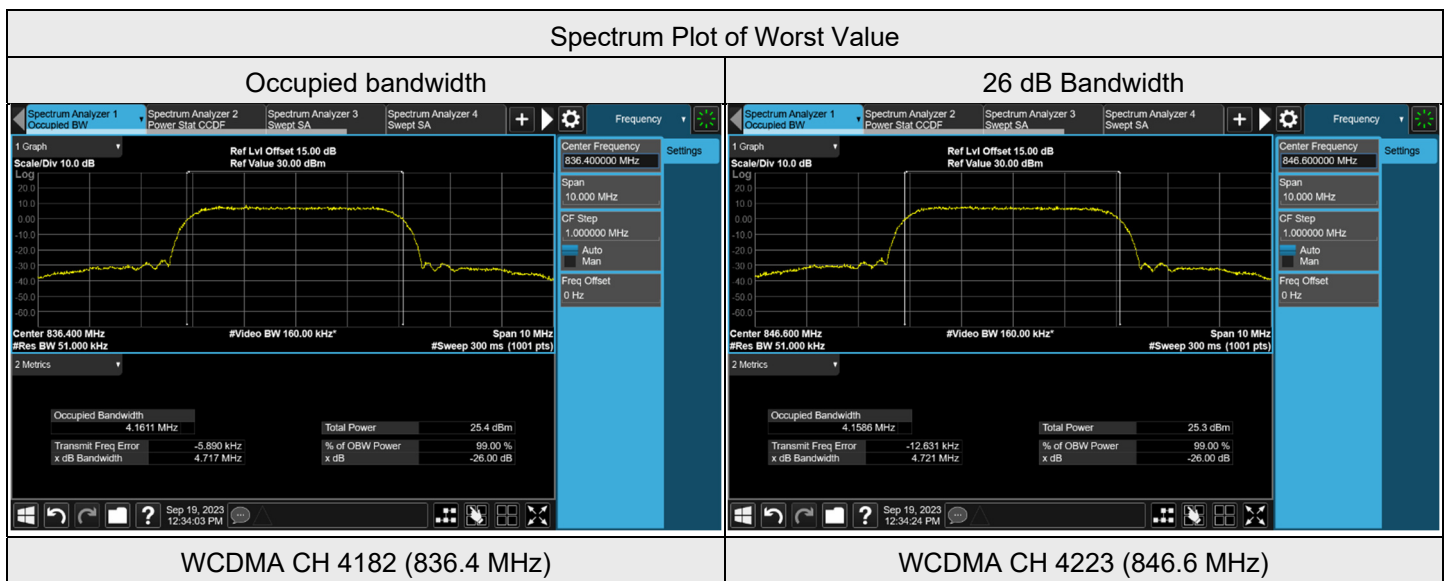

7.4.4 LTE Band 2

LTE Band 2, Channel Bandwidth: 1.4 MHz

Modulation	Channel	Frequency (MHz)	Occupied Bandwidth (MHz)	26 dB Bandwidth (MHz)
QPSK	18607	1850.7	1.0891	1.261
QPSK	18900	1880	1.0909	1.263
QPSK	19193	1909.3	1.0909	1.258
16QAM	18607	1850.7	1.0884	1.247
16QAM	18900	1880	1.0882	1.253
16QAM	19193	1909.3	1.0877	1.245

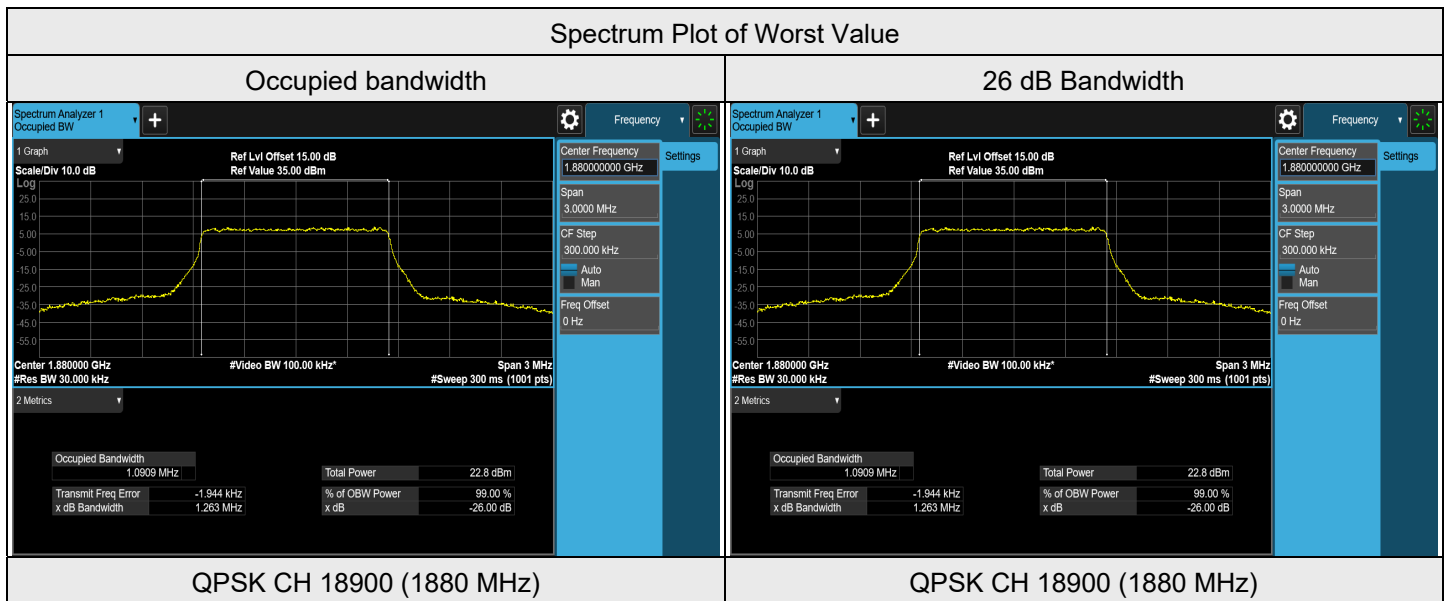

LTE Band 2, Channel Bandwidth: 3 MHz

Modulation	Channel	Frequency (MHz)	Occupied Bandwidth (MHz)	26 dB Bandwidth (MHz)
QPSK	18615	1851.5	2.6990	2.907
QPSK	18900	1880	2.6985	2.907
QPSK	19185	1908.5	2.6966	2.914
16QAM	18615	1851.5	2.6991	2.924
16QAM	18900	1880	2.7000	2.924
16QAM	19185	1908.5	2.6973	2.914

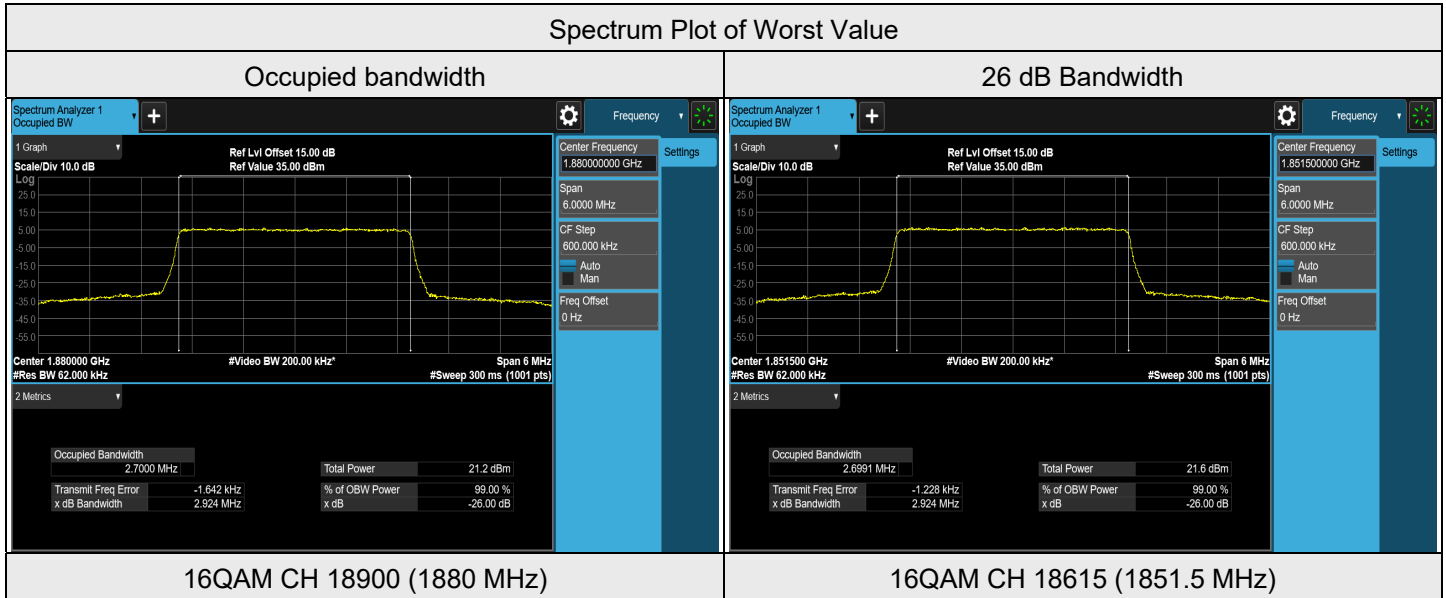



LTE Band 2, Channel Bandwidth: 5 MHz

Modulation	Channel	Frequency (MHz)	Occupied Bandwidth (MHz)	26 dB Bandwidth (MHz)
QPSK	18625	1852.5	4.4981	4.832
QPSK	18900	1880	4.4957	4.835
QPSK	19175	1907.5	4.4953	4.844
16QAM	18625	1852.5	4.4922	4.822
16QAM	18900	1880	4.4921	4.815
16QAM	19175	1907.5	4.4916	4.814

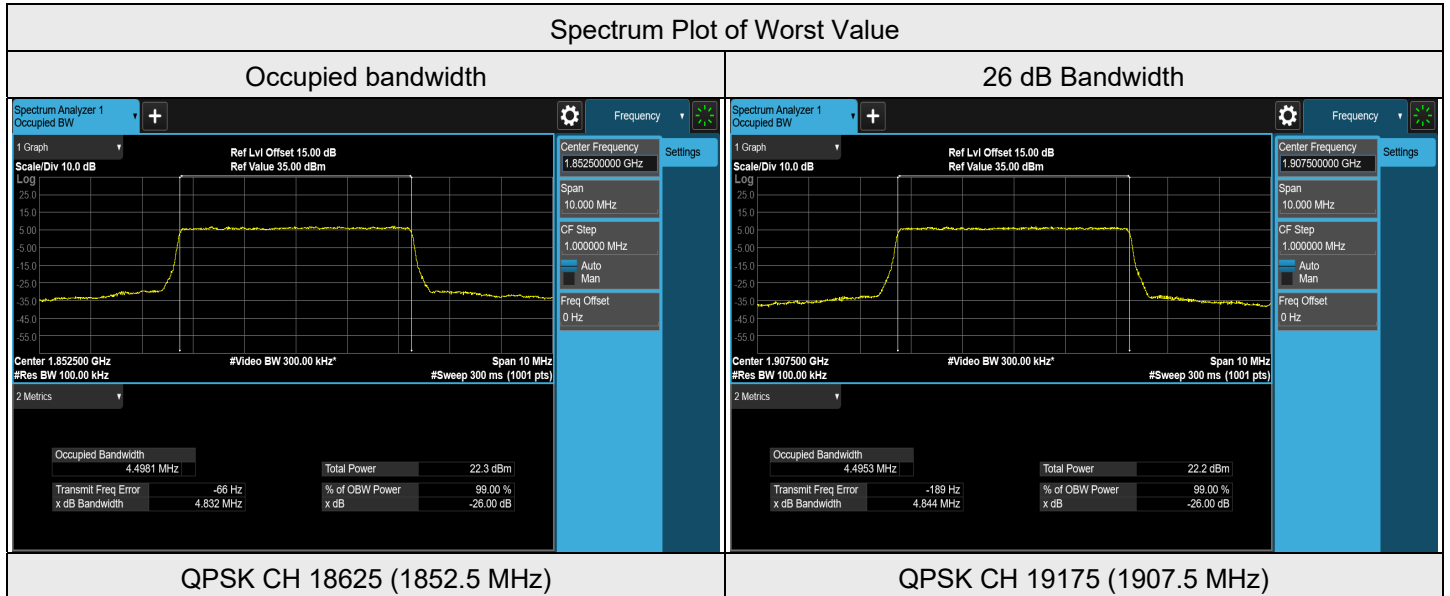

LTE Band 2, Channel Bandwidth: 10 MHz

Modulation	Channel	Frequency (MHz)	Occupied Bandwidth (MHz)	26 dB Bandwidth (MHz)
QPSK	18650	1855	8.9636	9.533
QPSK	18900	1880	8.9669	9.516
QPSK	19150	1905	8.9631	9.509
16QAM	18650	1855	4.5695	5.083
16QAM	18900	1880	4.5666	5.118
16QAM	19150	1905	4.5668	5.092

Spectrum Plot of Worst Value

