

3D Antenna Measurement Summary Report APPENDIX A2

REPORT NO.: ORBDKX-WTW-P22120419

MODEL NAME: H4

TESTED DATE: 2023.2.15

ISSUED: 2023.3.30

APPLICANT : Level Home Inc.

ADDRESS : 935 Main Street, Redwood City, California 94063, United States of America

ISSUED BY: Bureau Veritas Consumer Products Service(Hong Kong) Limited, Taoyuan Branch Mobile Communication Laboratory

ADDRESS: No.19, Hwa Ya 2nd Rd., Kwei shan Dist., Taoyuan City, Taiwan (R.O.C)

This report should not be used by the client to claim product certification, approval, or endorsement by TAF, CTIA or any government agencies.



This report is governed by, and incorporates by reference, the Conditions of Testing as posted at the date of issuance of this report at <http://www.bureauveritas.com/home/about-us/our-business/cps/about-us/terms-conditions/> and is intended for your exclusive use. Any copying or replication of this report to or for any other person or entity, or use of our name or trademark, is permitted only with our prior written permission. This report sets forth our findings solely with respect to the test samples identified herein. The results set forth in this report are not indicative or representative of the quality or characteristics of the lot from which a test sample was taken or any similar or identical product unless specifically and expressly noted. Our report includes all of the tests requested by you and the results thereof based upon the information that you provided to us. Measurement uncertainty is only provided upon request for accredited tests. Statements of conformity are based on simple acceptance criteria without taking measurement uncertainty into account, unless otherwise requested in writing. You have 60 days from date of issuance of this report to notify us of any material error or omission caused by our negligence or if you require measurement uncertainty; provided, however, that such notice shall be in writing and shall specifically address the issue you wish to raise. A failure to raise such issue within the prescribed time shall constitute your unqualified acceptance of the completeness of this report, the tests conducted and the correctness of the report contents.



RELEASE CONTROL RECORD

REPORT NO.	REASON FOR CHANGE	DATE ISSUED
ORBDKX-WTW-P22120419	Original release	2023.3.30

TABLE OF CONTENTS

GENERAL INFORMATION.....	3
APPENDIX. 3D Antenna Patterns	4
A2. LTE Antenna_J11	4



GENERAL INFORMATION

APPLICANT:	Level Home Inc.
MODEL NAME:	H4
MEASUREMENT STATNDARD	ANSI/IEEE 149 1979.

TESTED BY : Oscar Chiu , **DATE :** 2023.3.30
Oscar Chiu / Engineer

PREPARED BY : Johnny Liu , **DATE :** 2023.3.30
Johnny Liu / Supervisor

APPROVED BY : Ken Chan , **DATE :** 2023.3.30
Ken Chan / Manager

APPENDIX. 3D Antenna Patterns

A2. LTE Antenna_J11

700MHz
Total

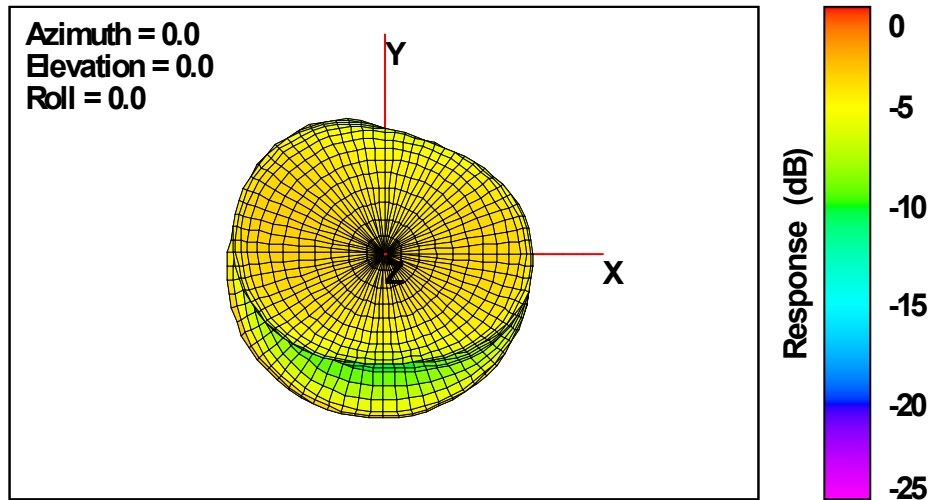

Total

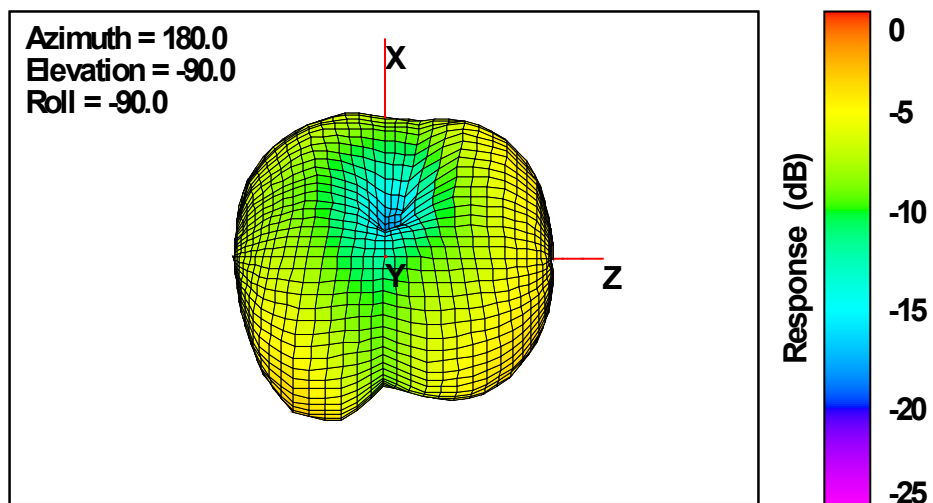



BUREAU
VERITAS

Total

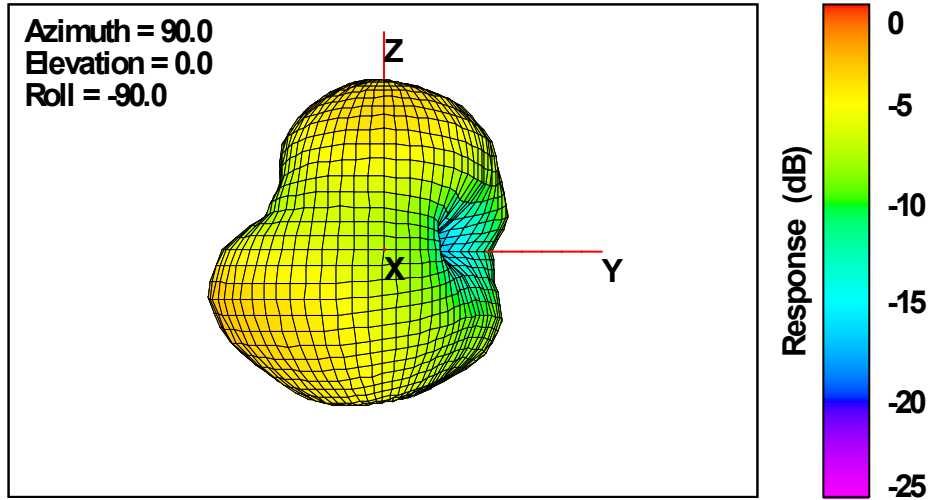

750MHz
Total

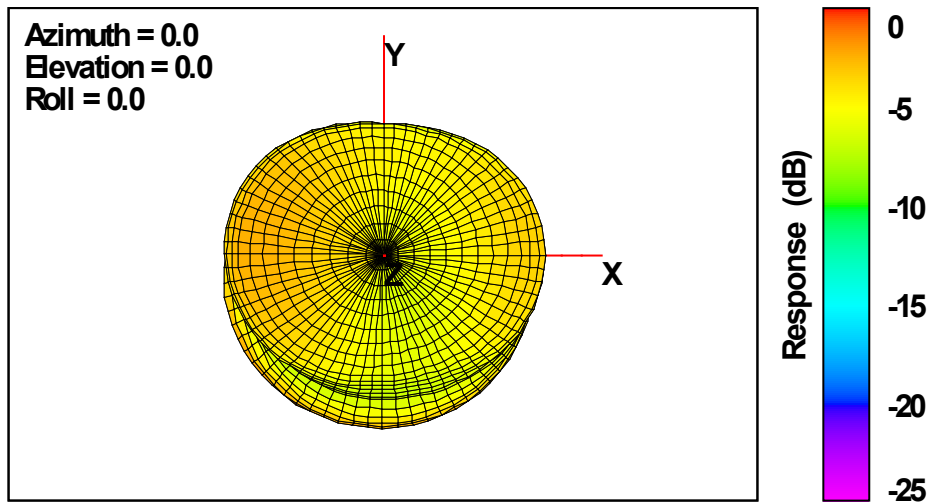

Total

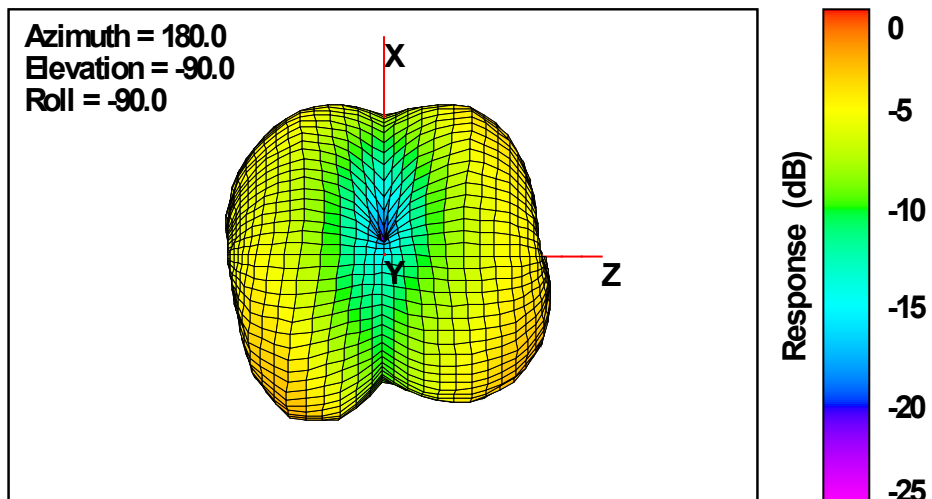

Total

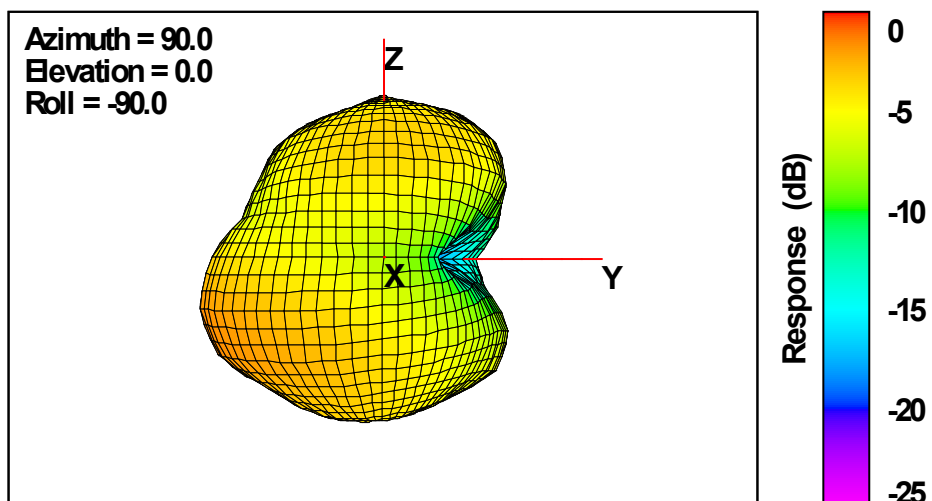

**800MHz
Total**

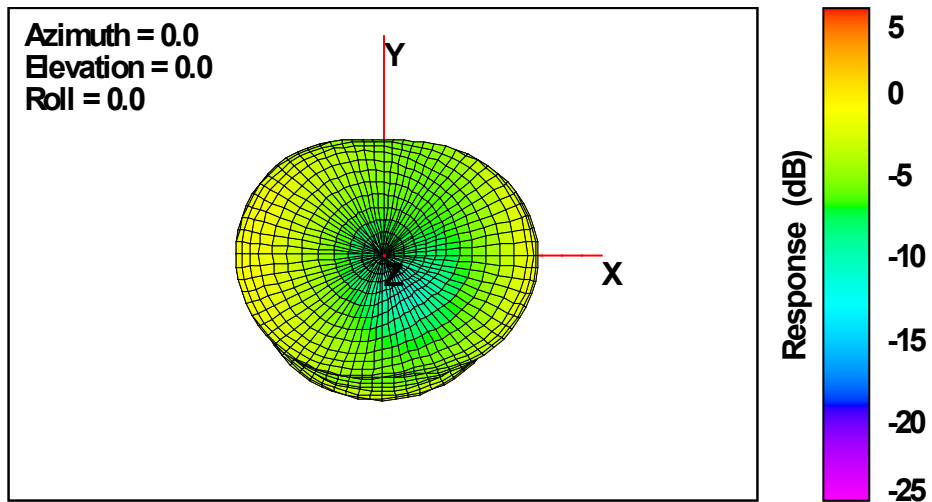

Total

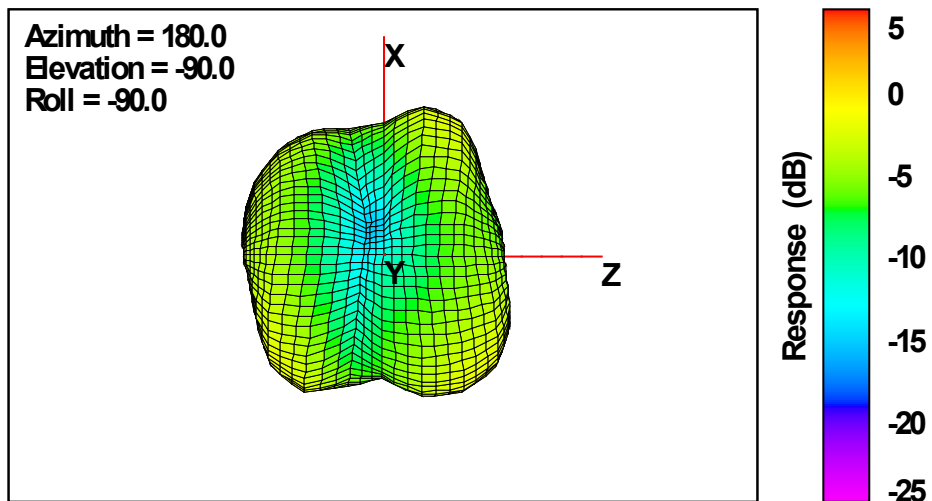

Total

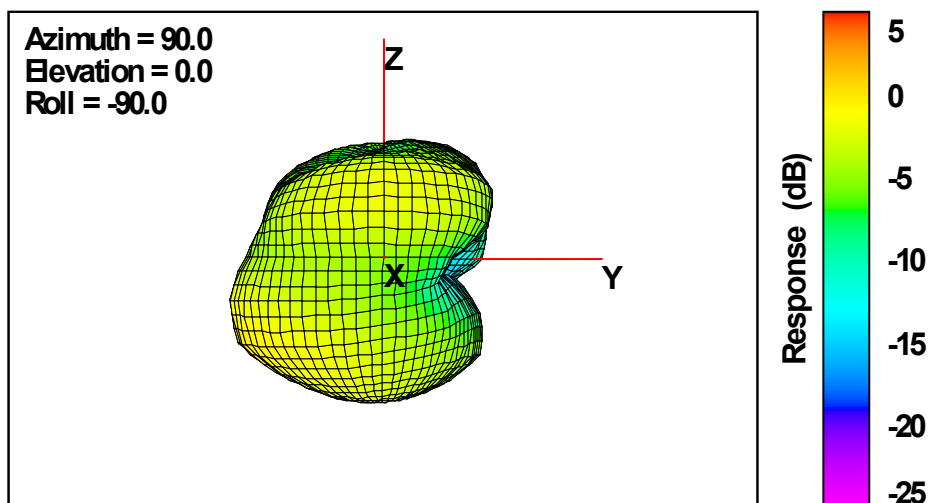

850MHz
Total

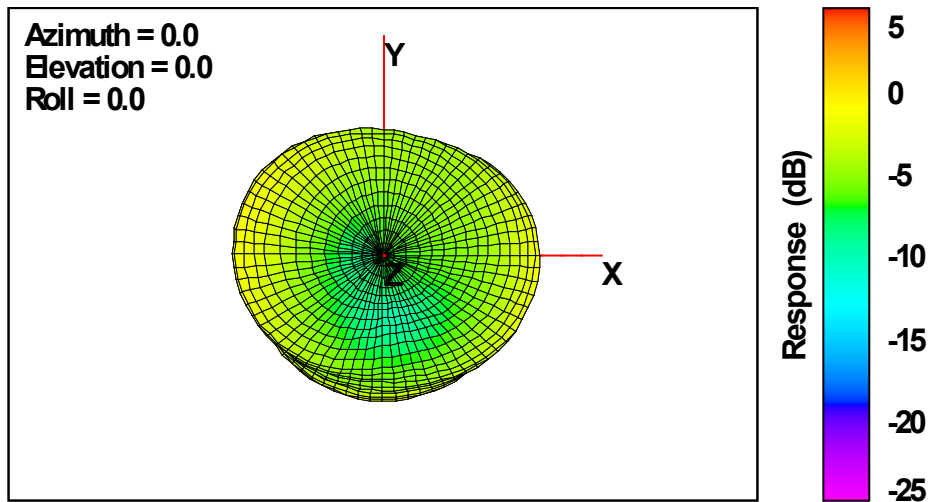

Total

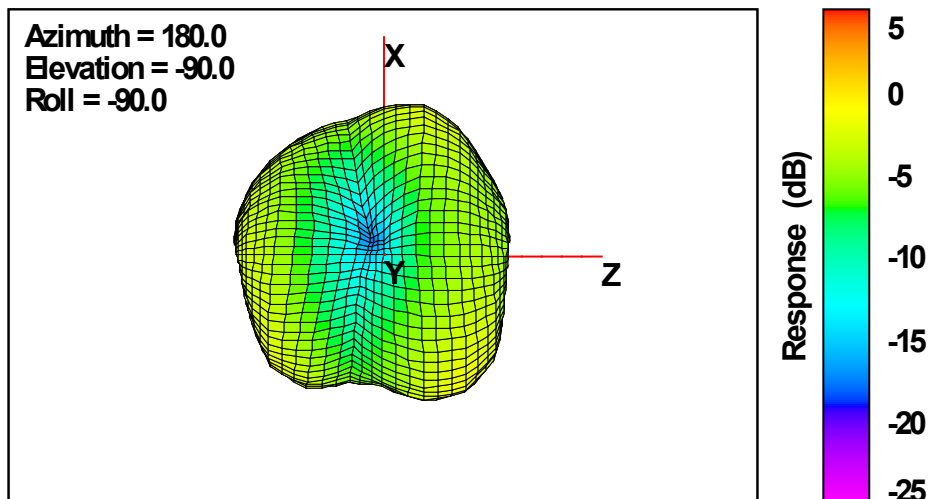

Total

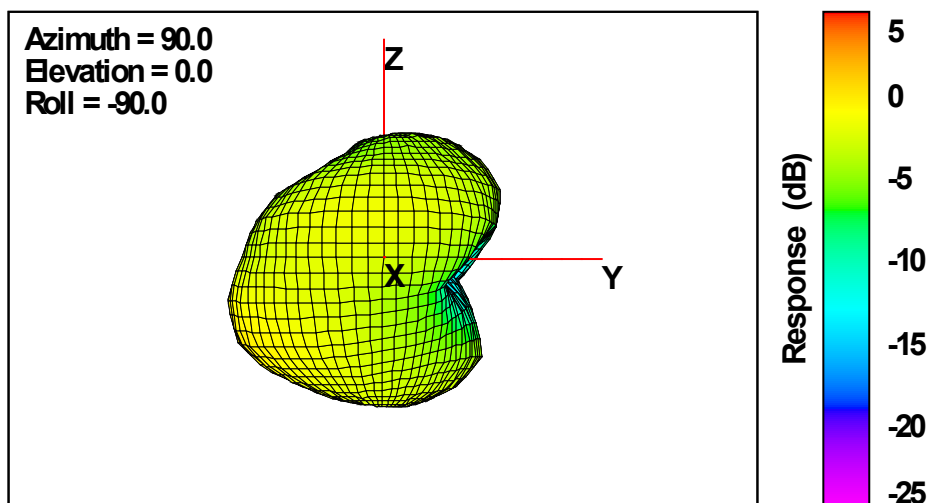

900MHz
Total

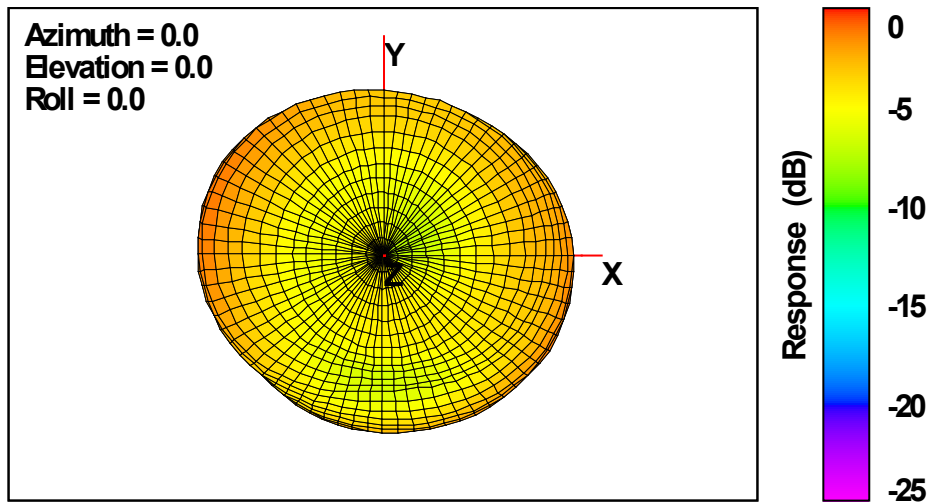

Total

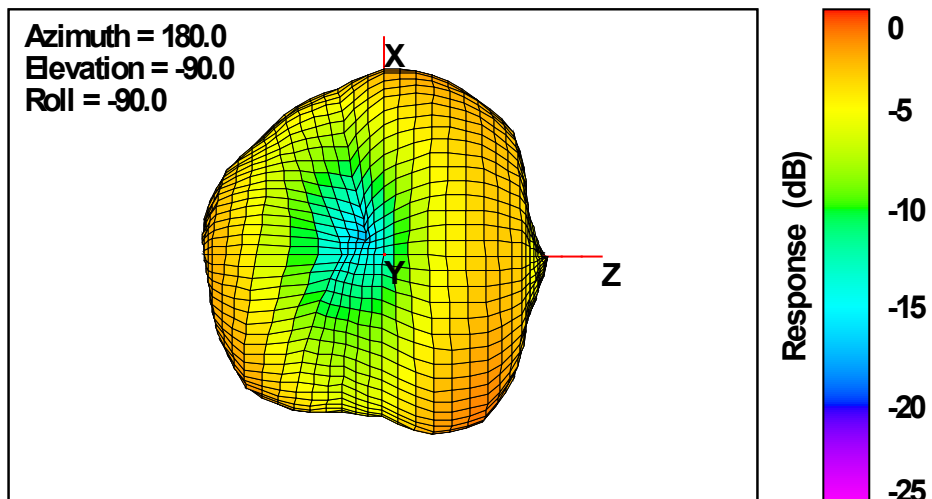

Total

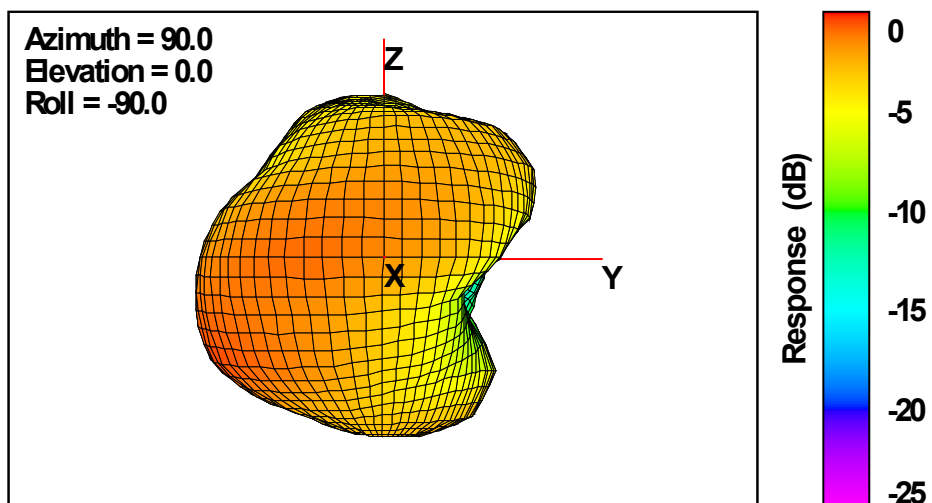

1700MHz
Total

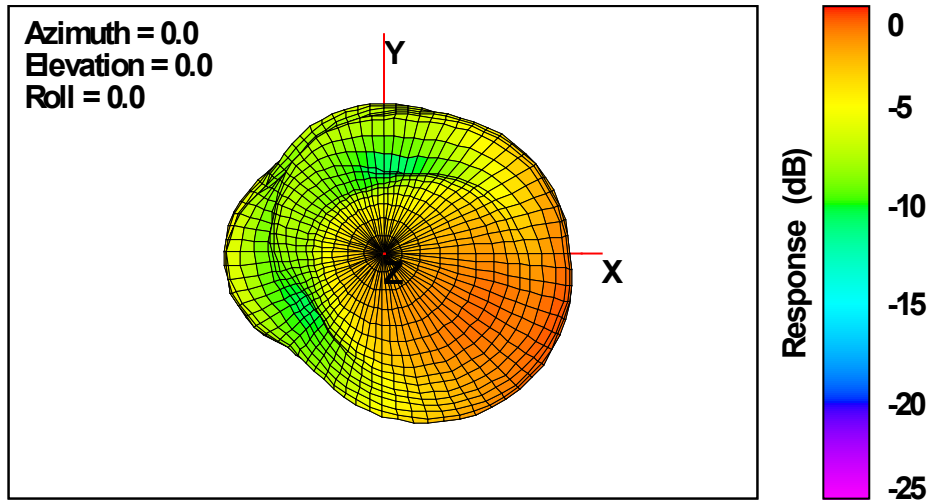

Total

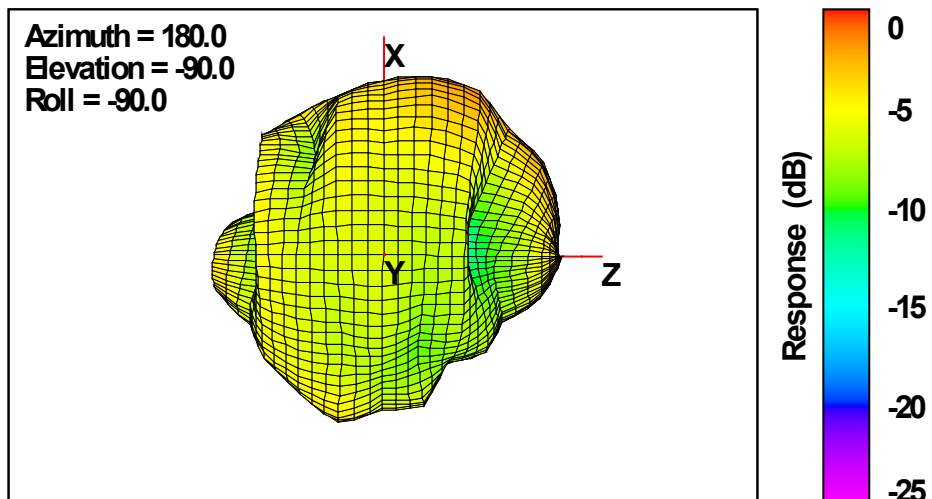

Total

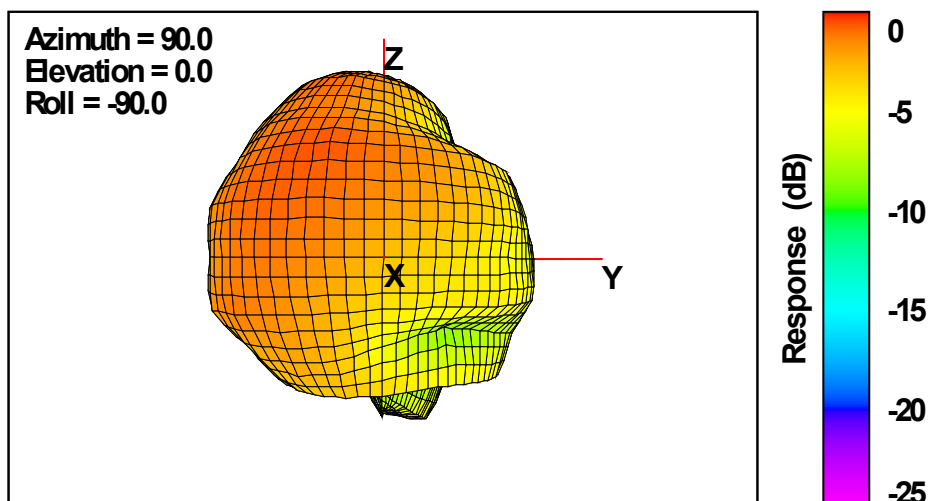

1750MHz
Total

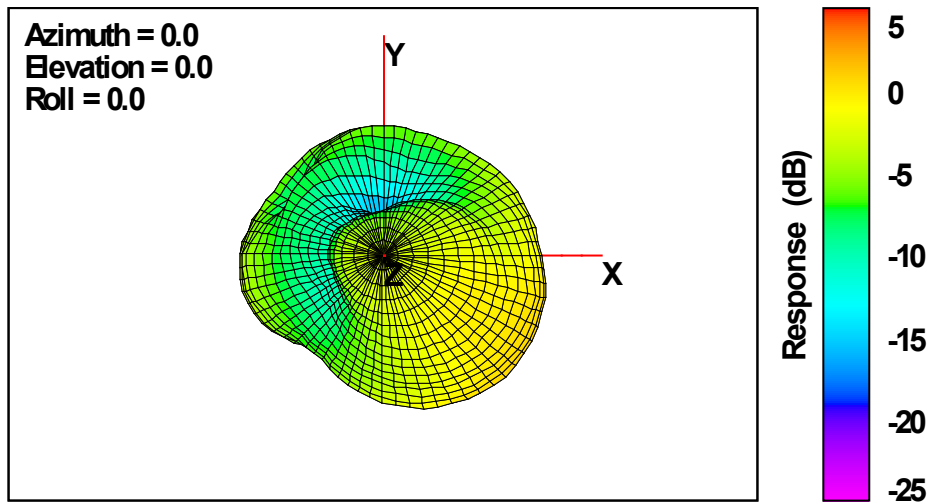

Total

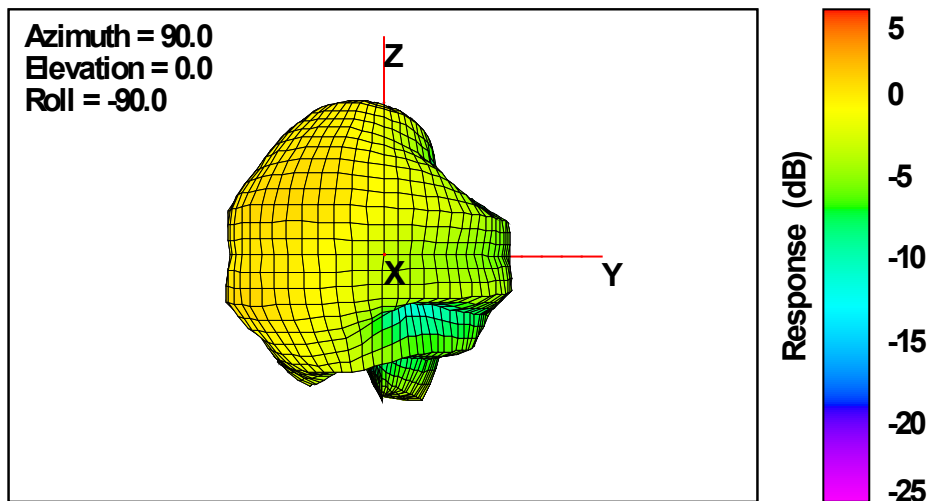

Total

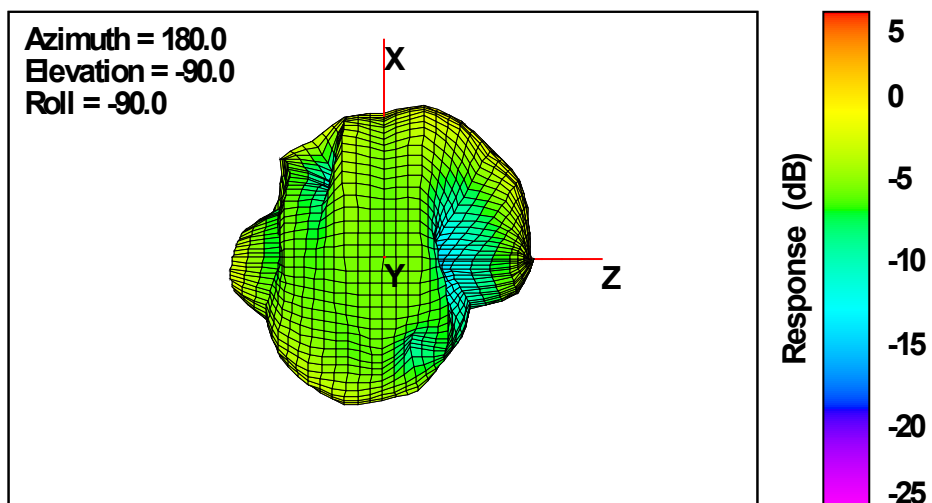

**1800MHz
Total**

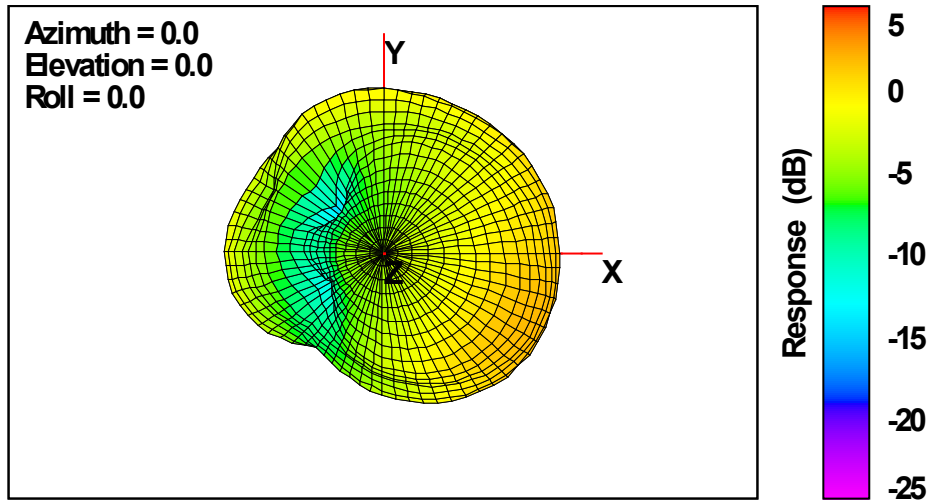

Total

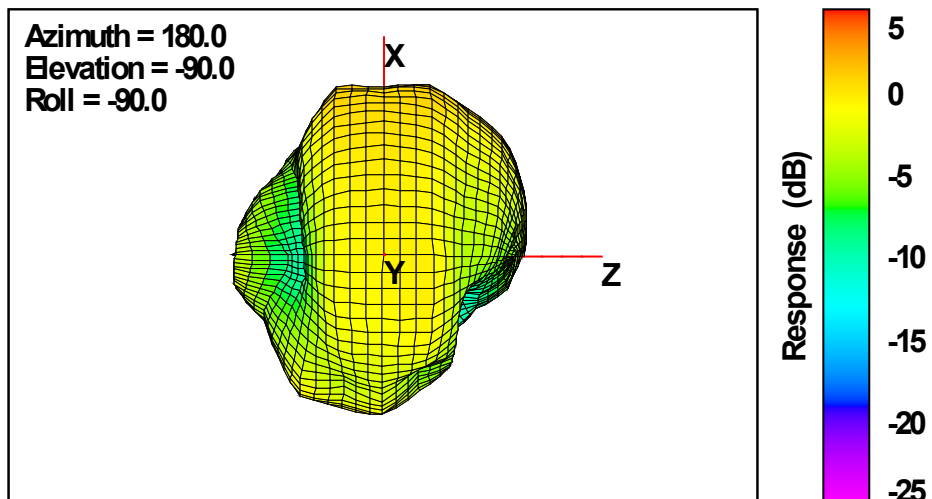

Total

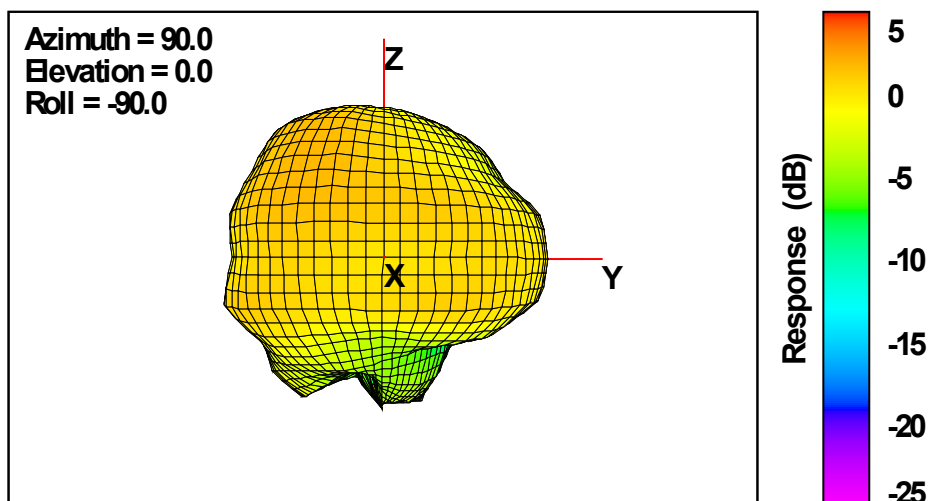

1850MHz
Total

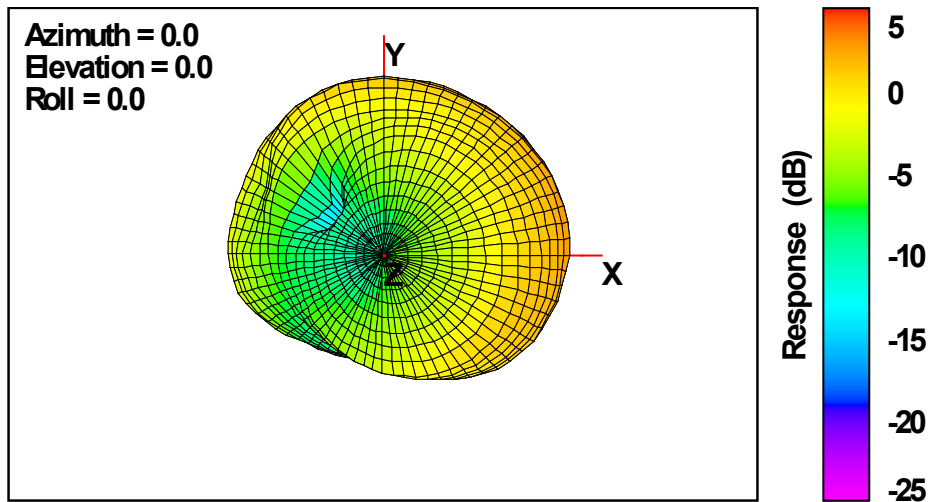

Total

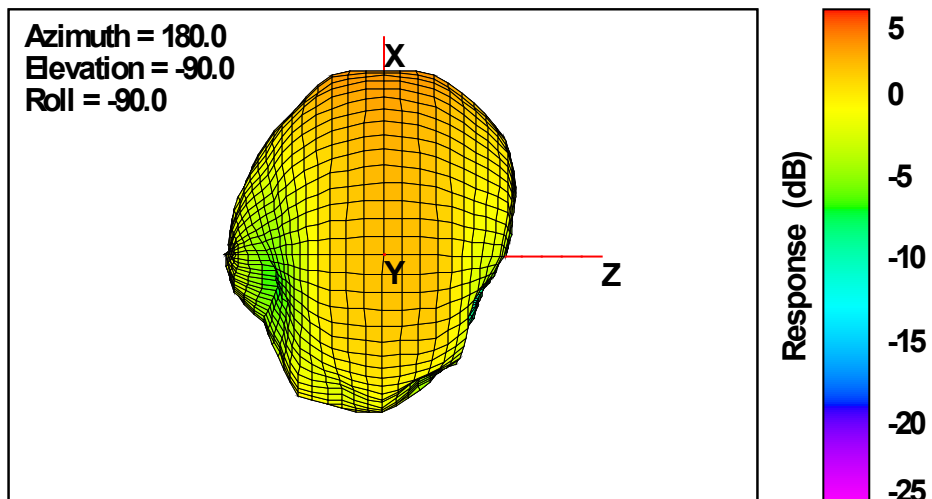

Total

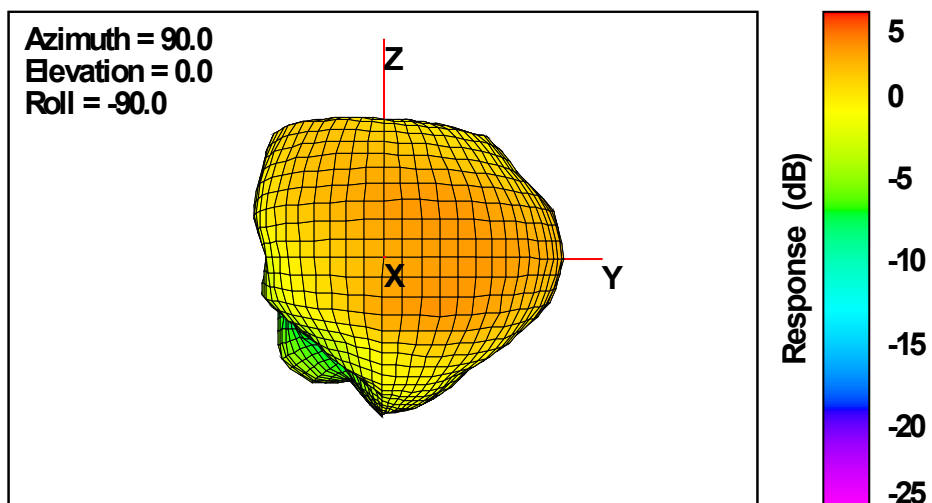

1900MHz
Total

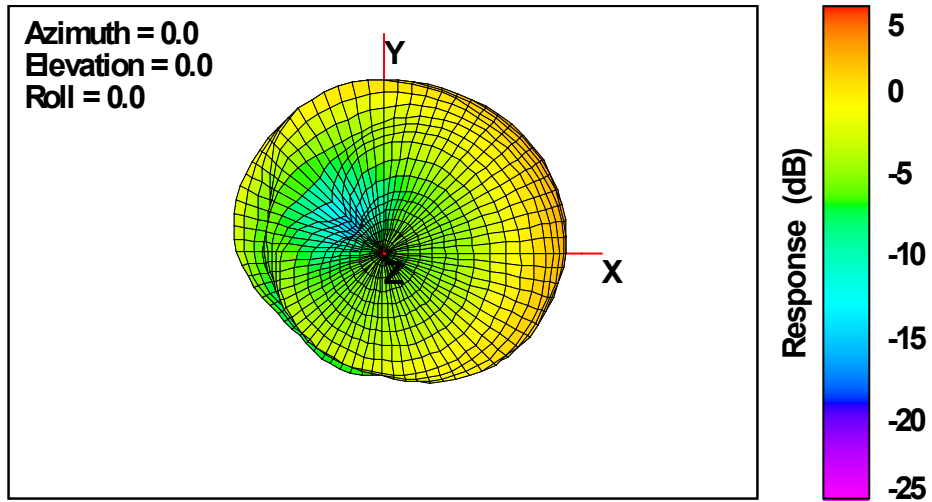

Total

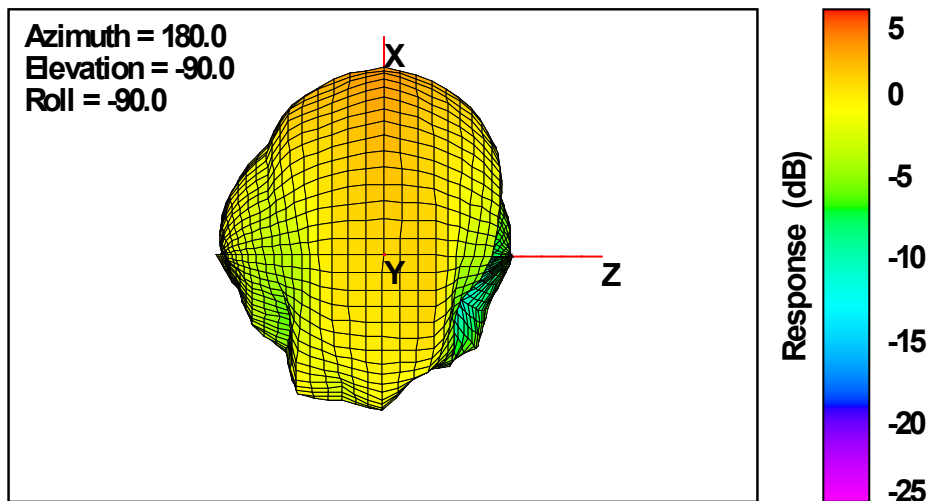

Total

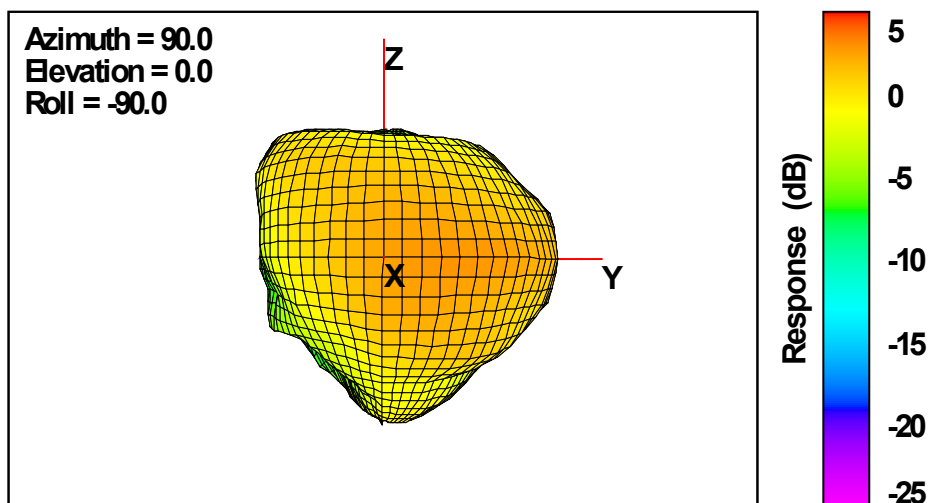

**1950MHz
Total**

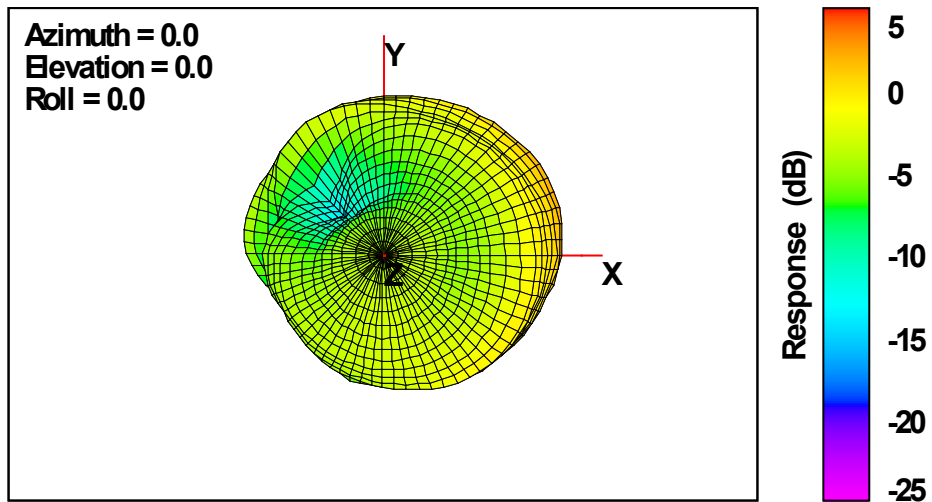

Total

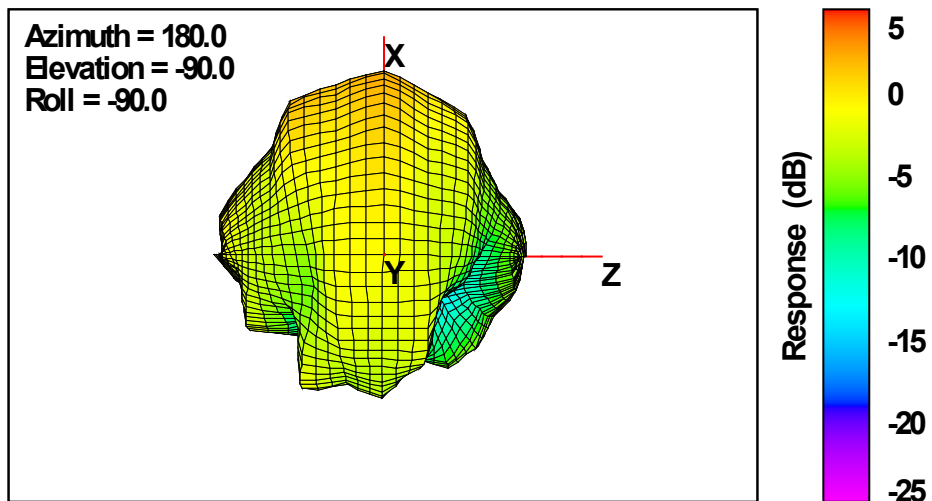

Total

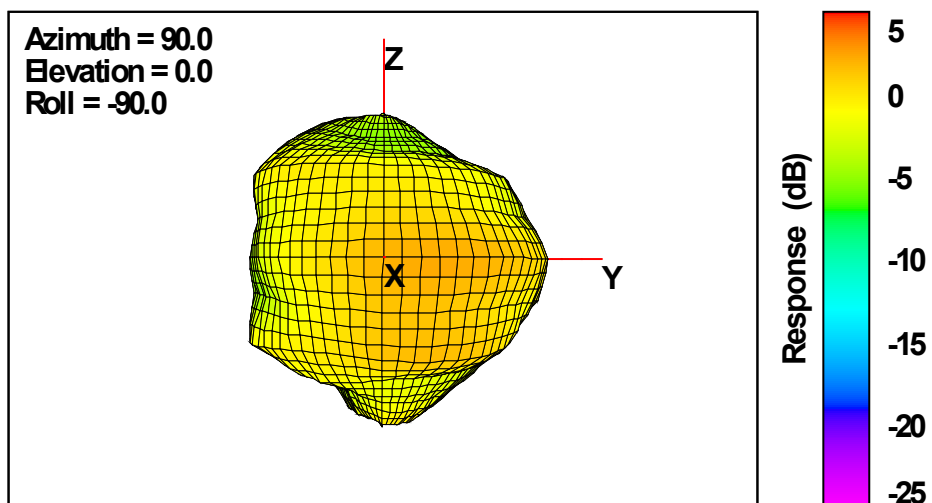

2000MHz
Total

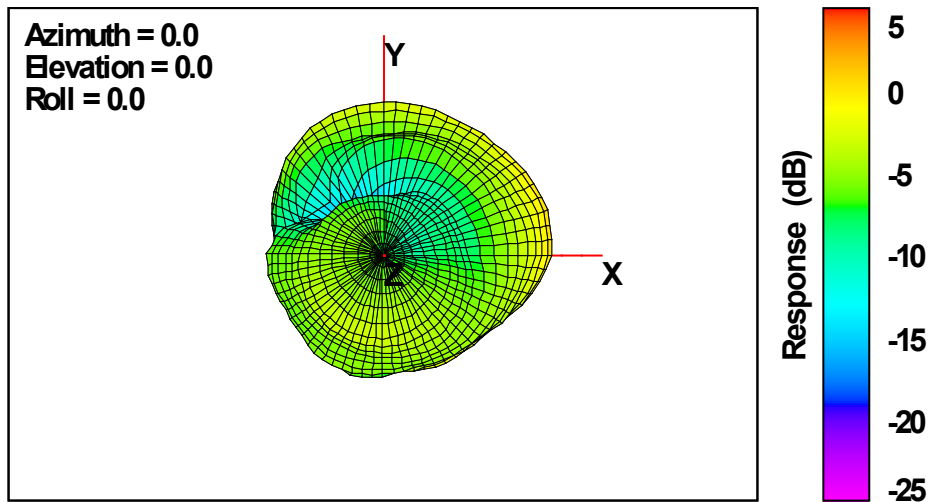

Total

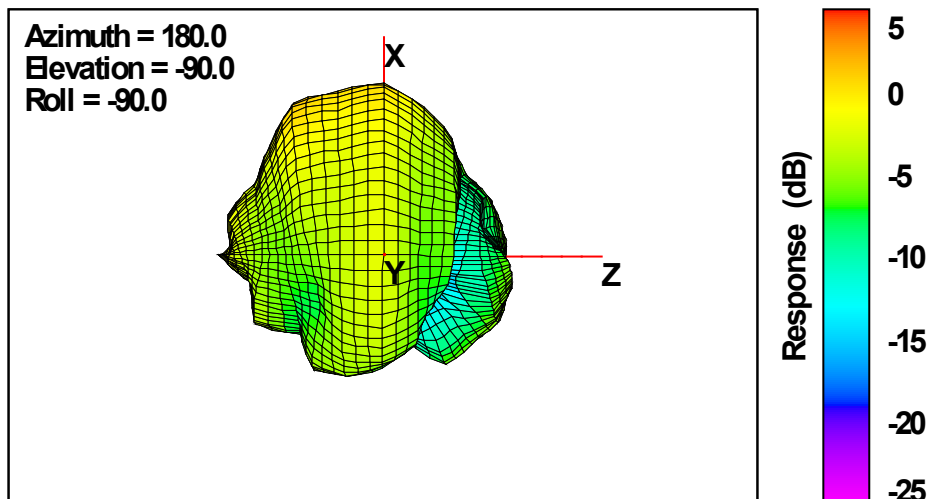

Total

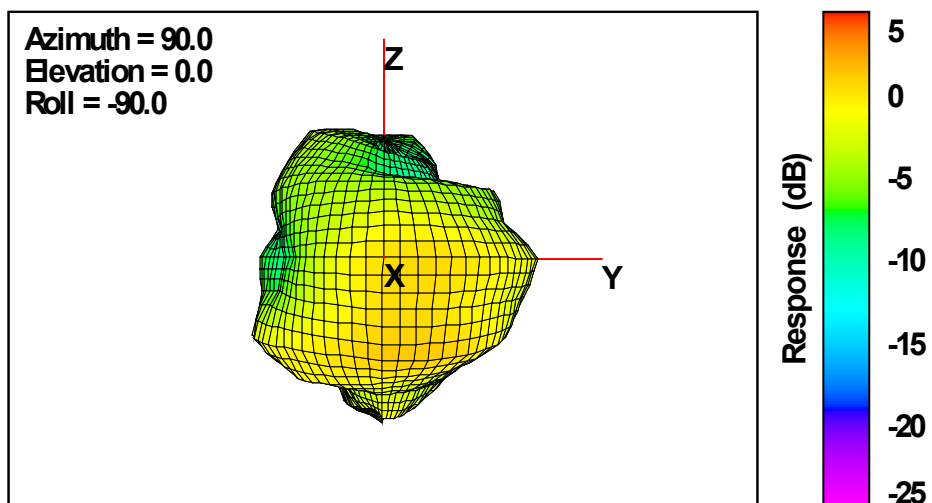

**2100MHz
Total**

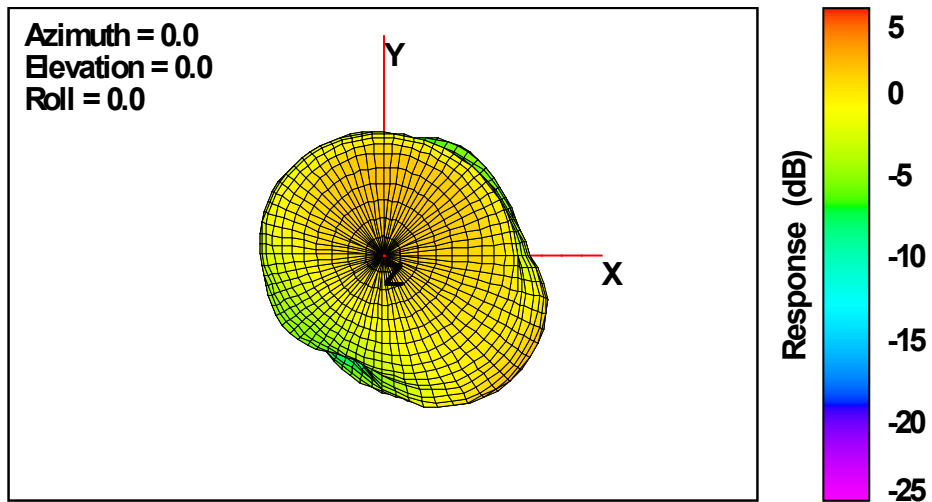

Total

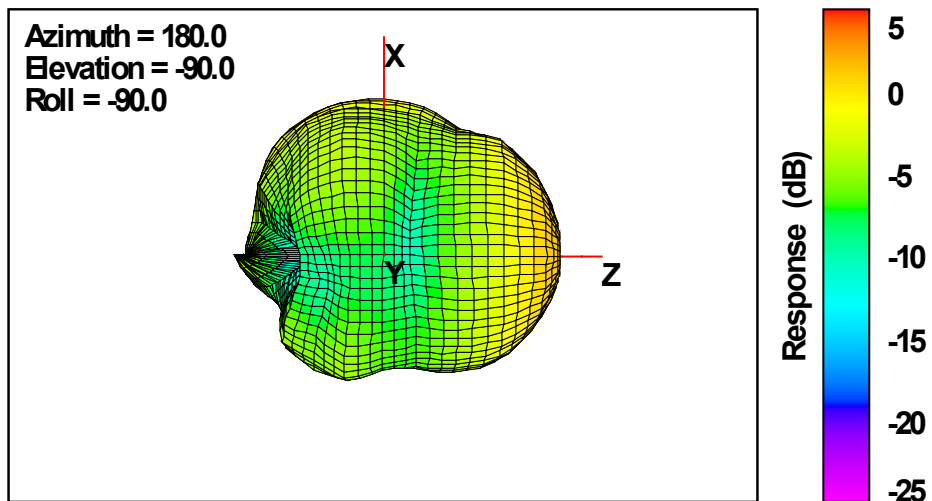

Total

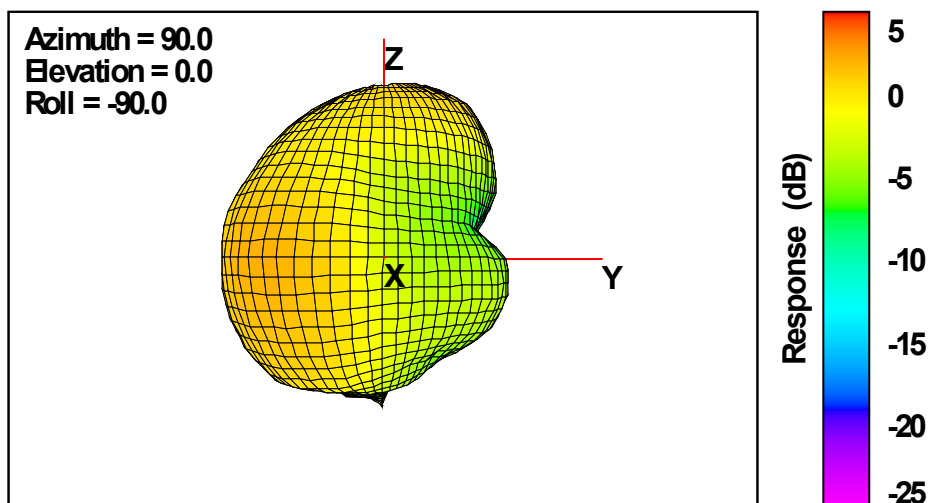

2150MHz
Total

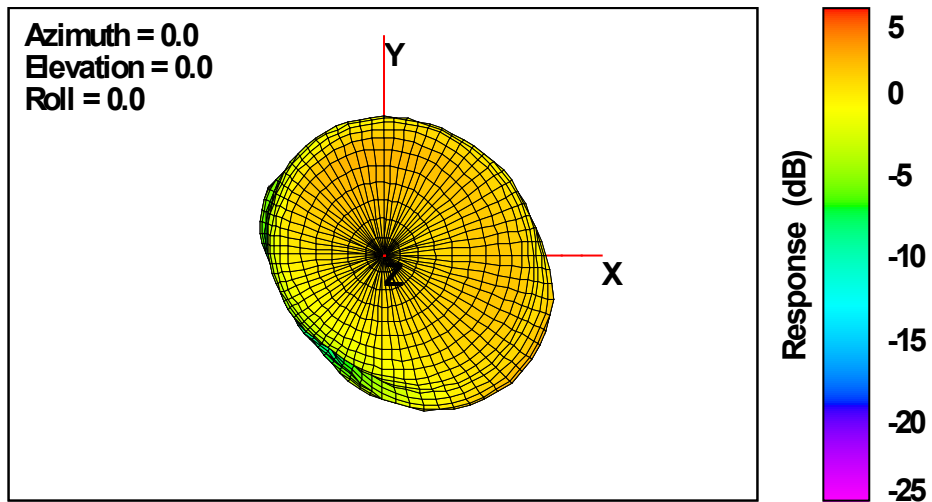

Total

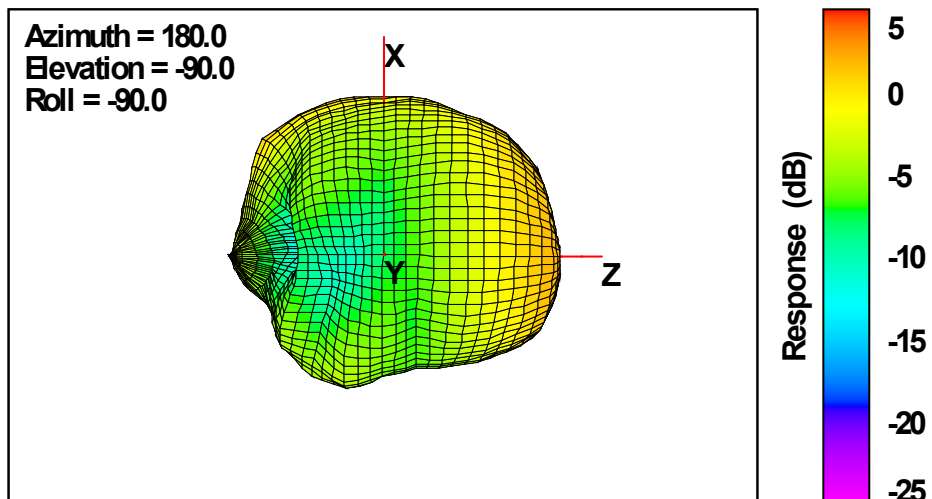

Total

