



TEST REPORT

Report No.: SRTC2020-9003(R)-0049
Product Name: Notification Pager Receiver
Model Name: P0004930100R
Applicant: SoftBank Robotics Corp.
Manufacturer: SoftBank Robotics Corp.
Specification: RSS-Gen (Issue 5, Amendment 1, March 2019)
IC ID: 25110-P000493010R

The State Radio_monitoring_center Testing Center (SRTC)
15th Building, No.30 Shixing Street, Shijingshan District,
Beijing, China

Tel: 86-10-57996183 Fax: 86-10-57996388

CONTENTS

1. General information	3
1.1 Notes of the test report	3
1.2 Information about the testing laboratory.....	3
1.3 Applicant's details	3
1.4 Manufacturer's details.....	3
1.5 Application details	4
1.6 Reference specification.....	4
1.7 Information of EUT	4
1.7.1 General information.....	4
1.7.2EUT details	5
1.7.3 Auxiliary equipment details.....	5
2. Test information	6
2.1 Summary of the test results	6
2.2 Test result.....	7
2.2.1Conducted Emissions- RSS-GEN.7.2	7
2.2.2RadiatedEmissions- RSS-GEN.7.3	10
2.3. List of test equipments	14

1. General information

1.1 Notes of the test report

The test report may only be reproduced or published in full. Reproduction or publication of extracts from the report requires the prior written permission of The State Radio_monitoring_center Testing Center (SRTC).

The test results relate only to individual items of the samples which have been tested.

1.2 Information about the testing laboratory

Company: The State Radio_monitoring_center Testing Center (SRTC)
Address: 15th Building, No.30 Shixing Street, Shijingshan District
Testing location: No.80, Zhaojiachang, BeizangCun, Daxing District, Beijing, China.
City: Beijing
Country or Region: China
Contacted person: Liu Jia
Tel: +86 10 57996183
Fax: +86 10 57996388
Email: liujiaf@srtc.org.cn

1.3 Applicant's details

Company: SoftBank Robotics Corp.
Address: 1-9-2 Higashi-shimbashi, Minato-ku, Tokyo, Japan
City: Tokyo
Country or Region: Japan
Contacted person: Huijun Wang
Tel: 81-3-6889-2450
Email: huijun.wang@g.softbank.co.jp

1.4 Manufacturer's details

Company: SoftBank Robotics Corp.
Address: 1-9-2 Higashi-shimbashi, Minato-ku, Tokyo, Japan
City: Tokyo
Country or Region: Japan
Contacted person: Huijun Wang
Tel: 81-3-6889-2450
Email: huijun.wang@g.softbank.co.jp

1.5 Application details

Date of reception of test sample: 3th Aug. 2020

Date of test: 3th Aug. 2020 to 12th Aug. 2020

1.6 Reference specification

RSS-Gen—General Requirements for Compliance of Radio Apparatus(Issue 5, Amendment 1, March 2019)

1.7 Information of EUT

1.7.1 General information

Name of EUT	Notification Pager Receiver
Model Name	P0004930100R
FCC ID	2AT19-P0004930100R
Frequency Range	Lora: 902-928MHz
Equipment Class	Class B
Power Supply	Battery or Charger
Rated Power Supply Voltage	5.0V
Extreme Temperature	Lowest: 0°C Highest: 45°C
Extreme Voltage	Minimum: 4.75V Maximum: 5.25V
HW Version	V1.1.0
SW Version	1.1

1.7.2 EUT details

Product Name	Model Name	IMEI
Notification Pager Receiver	P0004930100R	/

1.7.3 Auxiliary equipment details

AE (Auxiliary Equipment) 1#: USB Cable

Manufacturer	YUQIU ELECTRONICS CO.,LTD.
Model Number	1301187-00000-01

AE (Auxiliary Equipment) 2#: Battery

Type	Li-Lon
Manufacturer	APACK TECHNOLOGY CO., LTD.
Model Number	APP00332

AE (Auxiliary Equipment) 3#: Charger

Manufacturer	JIANGSU CHENYANG ELECTRON CO LTD
Model Number	SP-11N1201250-Z

Note1: The EUT is sold without power adapter. The Charger (AE3) was provided by laboratory. Just for test.

2. Test information

2.1 Summary of the test results

No.	Test case	FCC reference	Verdict
1	Conducted emissions	15.107	Pass
2	Radiated emissions	15.109	Pass

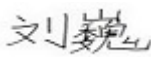
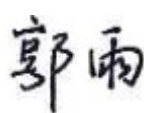
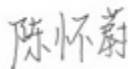
Approved By: Liu Wei Director of the test department 	Checked By: Guo Yu Vice director of the test department 
Tested By: Mr Chen Huaiwei 	Issued date: 2020.08.12

2.2 Test result

2.2.1 Conducted Emissions- RSS-GEN.7.2

Ambient condition:

Temperature	Relative humidity	Pressure
25.5°C	41.2%	101.2kPa

Test Setup with charger:

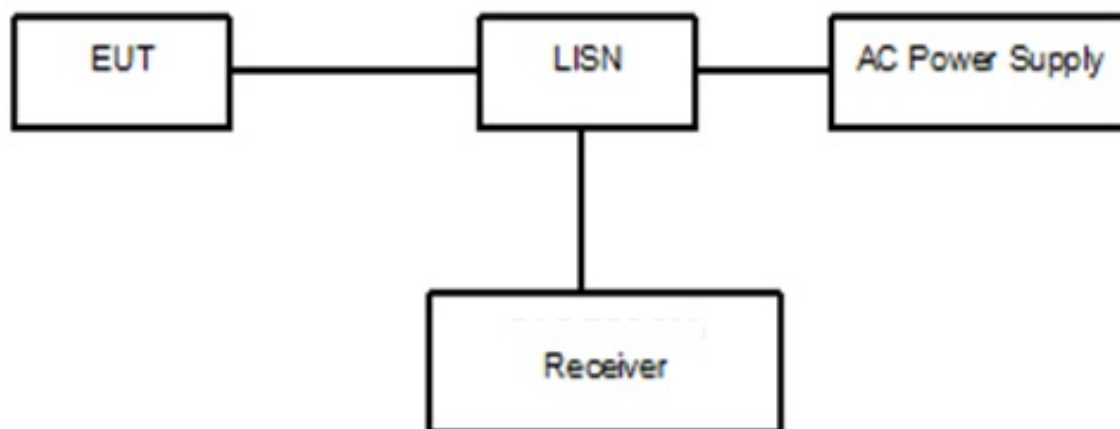

Figure 2

Test Procedure:

The EUT is placed on a non-metallic table 0.8m above the horizontal metal reference ground plane. The EUT is connected with LISN via the charger. The LISN is connected to the reference ground. The EUT was working at charging mode.

The test set-up and the test methods are performed according to ANSI C63.4:2014. Then start the test software EMC32. Sweep the whole frequency band through the range from 150 KHz to 30 MHz with RBW 9kHz, VBW 30kHz. The measurement should be done for both L line and N line. During pre-test, the receiver uses both peak detector and average detector. And the final test, the receiver uses both average detector and Quasi-peak detector.

The data of cable loss has been calibrated in full testing frequency range before the testing.

A "reference path loss" Corr.(dB) is established and the $L_{\text{cable}} + \text{ATT} + \text{VDF}$ is the attenuation of "reference path loss", and including the cable loss, the attenuation of the attenuator, the voltage division factor of AMN.

The measurement results are obtained as described below:

$$P_{\text{result}} = P_{\text{mea}} + \text{Corr. (dB)}$$

Sample calculation: $(29.85 \text{ dB}\mu\text{V}) = (0.15 \text{ dB}\mu\text{V}) + (29.7 \text{ dB})$, the corresponding frequency is 0.593486MHz.

Limit:

Frequency of Emission(MHz)	Limits(dB μ V)	
	Quasi-peak	Average
0.15~0.5	66 to 56*	56 to 46*
0.5~5	56	46
5~30	60	50

Note: * Decreases with the logarithm of the frequency

Test result:

Noise Level of the Measuring Instrument

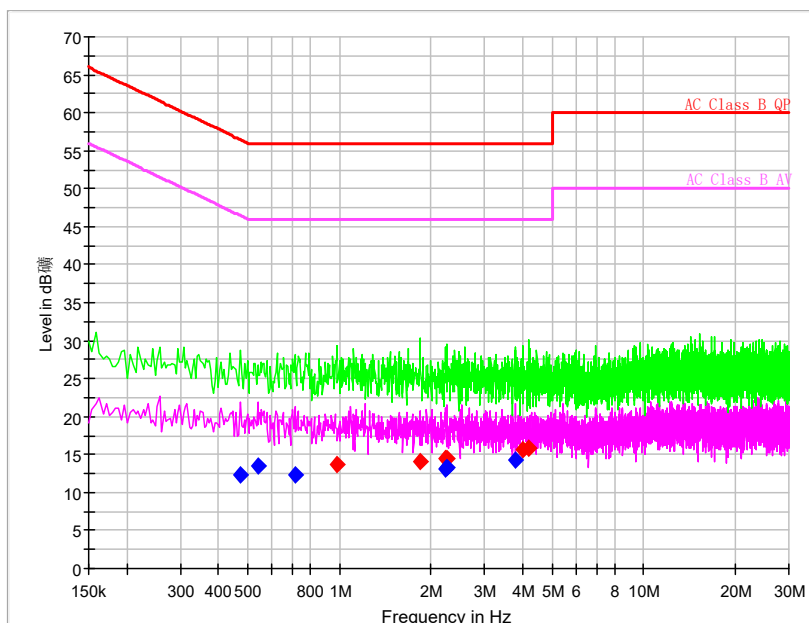

Pic1. Conducted emission L and N Line

EUT+1#USB Cable+2#Battery +3#Charger:

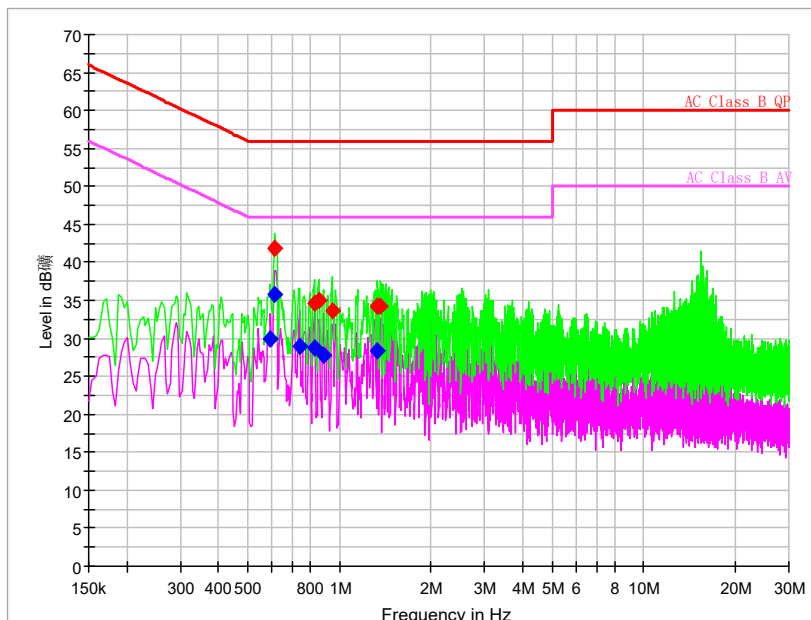

Pic2. Conducted emission L&N Line

Frequency (MHz)	QuasiPeak (dBµV)	Average (dBµV)	Limit (dBµV)	Margin (dB)	Line	Corr. (dB)	Pmea QuasiPeak (dBµV)	Pmea Average (dBµV)
0.593486	---	29.85	46.00	16.15	L	29.7	---	0.15
0.614807	---	35.84	46.00	10.16	L	29.7	---	6.14
0.614807	41.92	---	56.00	14.08	L	29.7	12.22	---
0.738471	---	28.95	46.00	17.05	L	29.7	---	-0.75
0.828021	---	28.65	46.00	17.35	L	29.7	---	-1.05
0.828021	34.62	---	56.00	21.38	L	29.7	4.92	---
0.853607	35.01	---	56.00	20.99	L	29.7	5.31	---
0.887721	---	27.74	46.00	18.26	N	29.7	---	-1.96
0.947421	33.69	---	56.00	22.31	L	29.7	3.99	---
1.331207	34.12	---	56.00	21.88	N	29.7	4.42	---
1.335471	---	28.44	46.00	17.56	N	29.7	---	-1.26
1.365321	34.26	---	56.00	21.74	L	29.7	4.56	---

2.2.2 Radiated Emissions- RSS-GEN.7.3

Ambient condition:

Temperature	Relative humidity	Pressure
25.5°C	41.2%	101.2kPa

Test Setup:

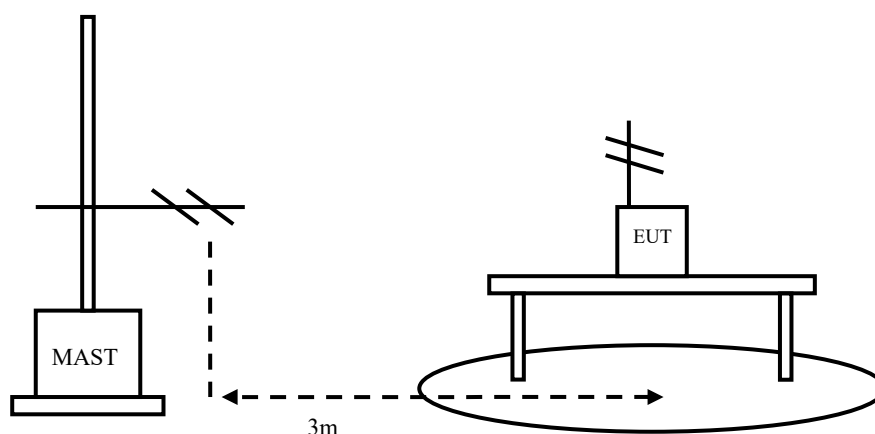

Figure 2

Test Procedure:

EUT+ charger:

The EUT should be placed on a non-metallic table 80cm above the ground plane. The receive antennas shall be moved from 1 to 4 meters. The distance between EUT and receive antenna should be 3 meters.

The EUT should work in charging mode and Receiver mode. The EUT is connected with the charger. The test set-up and the test methods are performed according to ANSI C63.4:2014.

Then start the test software EMC32. Sweep the whole frequency band through the range from 30MHz to 1GHz, using receive log period antenna VULB 9163.

During the test, the height of receive antenna shall be moved from 1 to 4 meters, and the antenna shall be performed under horizontal and vertical polarization. The turn table shall be rotated from 0 to 360 degrees for detecting the maximum of radiated spurious signal level. The measurements shall be repeated with orthogonal polarization of the test antenna. The EUT is laid in two modes as follow:
1. put the EUT in horizontal direction; 2. put the EUT in vertical direction.

The data of cable loss and antenna factor have been calibrated in full testing frequency range before the testing. All test results are performed with max hold at the horizontal and vertical polarity.

RBW=120kHz, VBW=300kHz, when the test frequency: 30MHz<f<1GHz

RBW=1MHz, VBW=3MHz, when the test frequency: f>1GHz

A “reference path loss” is established and the A_{Rpl} is the attenuation of “reference path loss”, and including the gain of receive antenna, the gain of the preamplifier, the cable loss.

The measurement results are obtained as described below:

$$\text{Result} = P_{\text{mea}} + A_{Rpl}$$

Limit:

Frequency of Emission(MHz)	Limits	
	Detector	Unit (dB μ V/m)
30~88	Quasi-peak	40
88~216	Quasi-peak	43.5
216~960	Quasi-peak	46
960~1000	Quasi-peak	54
1000~5th harmonic of the highest frequency or 40GHz, whichever is lower	Average	54
	Peak	74

Test result:

Sample calculation: (29.69 dB μ V/m) = (50.39 dB μ V/m) + (-20.7 dB), the corresponding frequency is 31.503500MHz.

EUT+1#USB Cable+2#Battery +3#Charger:

Frequency(MHz)	Result(dB μ V/m)	Limit (dB μ V/m)	ARpl (dB)	Pmea (dB μ V/m)	Polarity
31.503500	29.69	40.00	-20.7	50.39	V
64.144000	21.44	40.00	-19.8	41.24	V
104.302000	19.44	43.50	-19.0	38.44	V
233.409000	13.35	46.00	-17.0	30.35	V
542.742000	14.34	46.00	-8.1	22.44	V
827.825000	16.19	46.00	-2.8	18.99	V

EUT+1#USB Cable+2#Battery +3#Charger: refer to Pic3, Pic4, Pic5

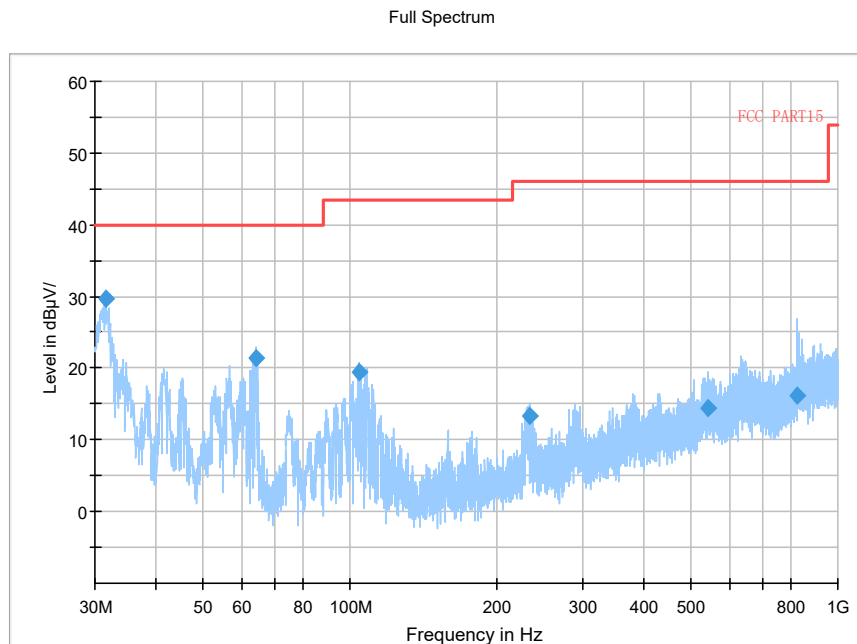

Pic3. Radiated emission(30MHz – 1GHz)

Note: The test data in the graph includes two polarizations: horizontal and vertical

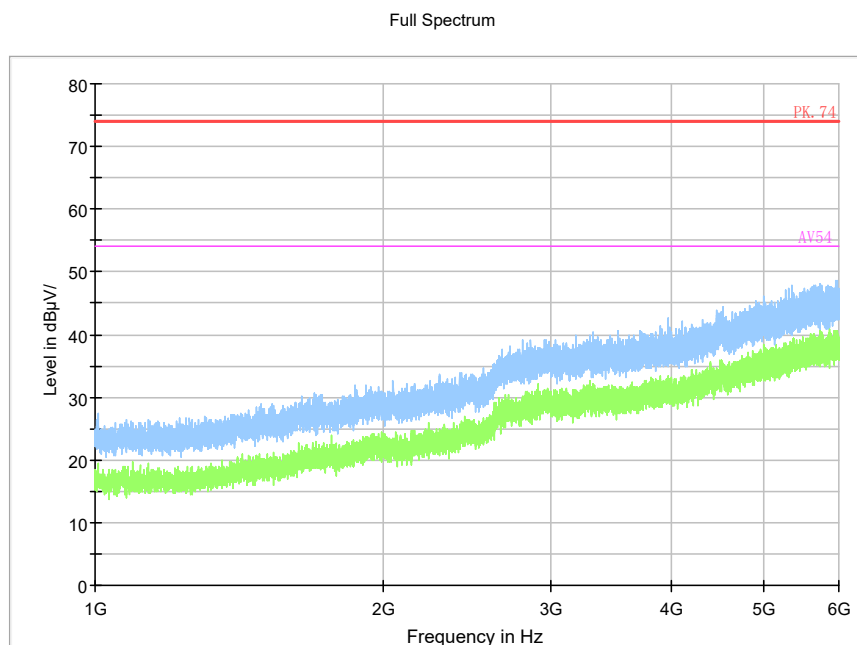

Pic4. Radiated emission (1GHz –6GHz)

Note: The test data in the graph includes two polarizations: horizontal and vertical.

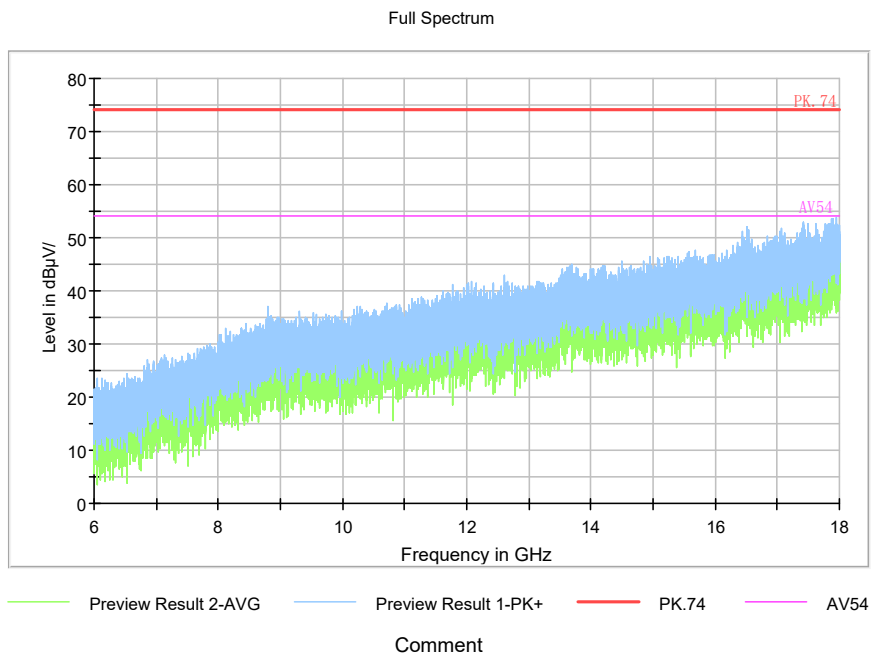

Pic5. Radiated emission (6GHz –18GHz)

Note: The test data in the graph includes two polarizations: horizontal and vertical.

2.3. List of test equipments

No.	Name/Model	Manufacturer	S/N	Calibration Due Date	Calibration Date
1	23.18m×16.88m×9.60mS emi-AnechoicChamber	FRANKONIA	-----	5th Sep. 2021	6th Sep. 2016
2	ESW EMI test receiver	R&S	101574	20th Aug. 2020	20th Aug. 2019
3	9.080m×5.255m×3.525m Shielding room	FRANKONIA	-----	5th Sep. 2021	6th Sep. 2016
4	ESR3 EMI test receiver	R&S	102361	21th Apr. 2021	20th Apr. 2020
5	VULB 9163 Ultra log test antenna	schwarzbeck	867	25th Mar. 2021	25th Mar. 2020
6	ENV216 AMN	R&S	3560.6550. 12	20th Aug. 2020	20th Aug. 2019
7	HF 907 Double-Ridged Waveguide Horn Antenna	R&S	100512	25th Mar. 2021	25th Mar. 2020
8	PS2000 Turn Table	FRANKONIA	-----	-----	-----
9	MA260 Antenna Master	FRANKONIA	-----	-----	-----
10	EMC32EMI test software	R&S	-----	-----	-----