



## BW433SNX23-5W4-5

Product specifications acknowledgment

Product Type		
Model	Description	Remarks
BW433SNX23-5W4-5	433mhz Spring Antenna	Customized

**Manufacturer: Shenzhen Bat Wireless Technology Co.,Ltd.**

Address: 1409,Building A,Zhiyun Industrial Park, No.13 Huaxing Rd,Longhua Dist, Shenzhen,Guangdong,CN

## 1. Specifications

<b>Antennas Type</b>	Spring Antenna
<b>Frequenc Range(MHz)</b>	433±5MHz
<b>Input Impedence (Ω)</b>	50Ω
<b>V.S.W.R</b>	<2
<b>Gain (dBi)</b>	2.67
<b>Polarization Type</b>	Vertical
<b>Power Capacity (w)</b>	50
<b>Lingtning Protection</b>	None
<b>DC Voltage (V)</b>	None
<b>Dimension (mm)</b>	23-5
<b>Connector Type:</b>	None
<b>Cable type (mm)</b>	None
<b>Cable length(mm)</b>	None
<b>Radiator</b>	Copper
<b>Color</b>	Yellow
<b>Weight(g)</b>	None
<b>Operating Temperature (℃)</b>	-40~80
<b>Storage Temperature (℃)</b>	-20~85

\* Note: The above data is for reference only; Because the antenna function is more sensitive, please inform us of any changes in the surrounding institutions.

## 2. Antenna Picture

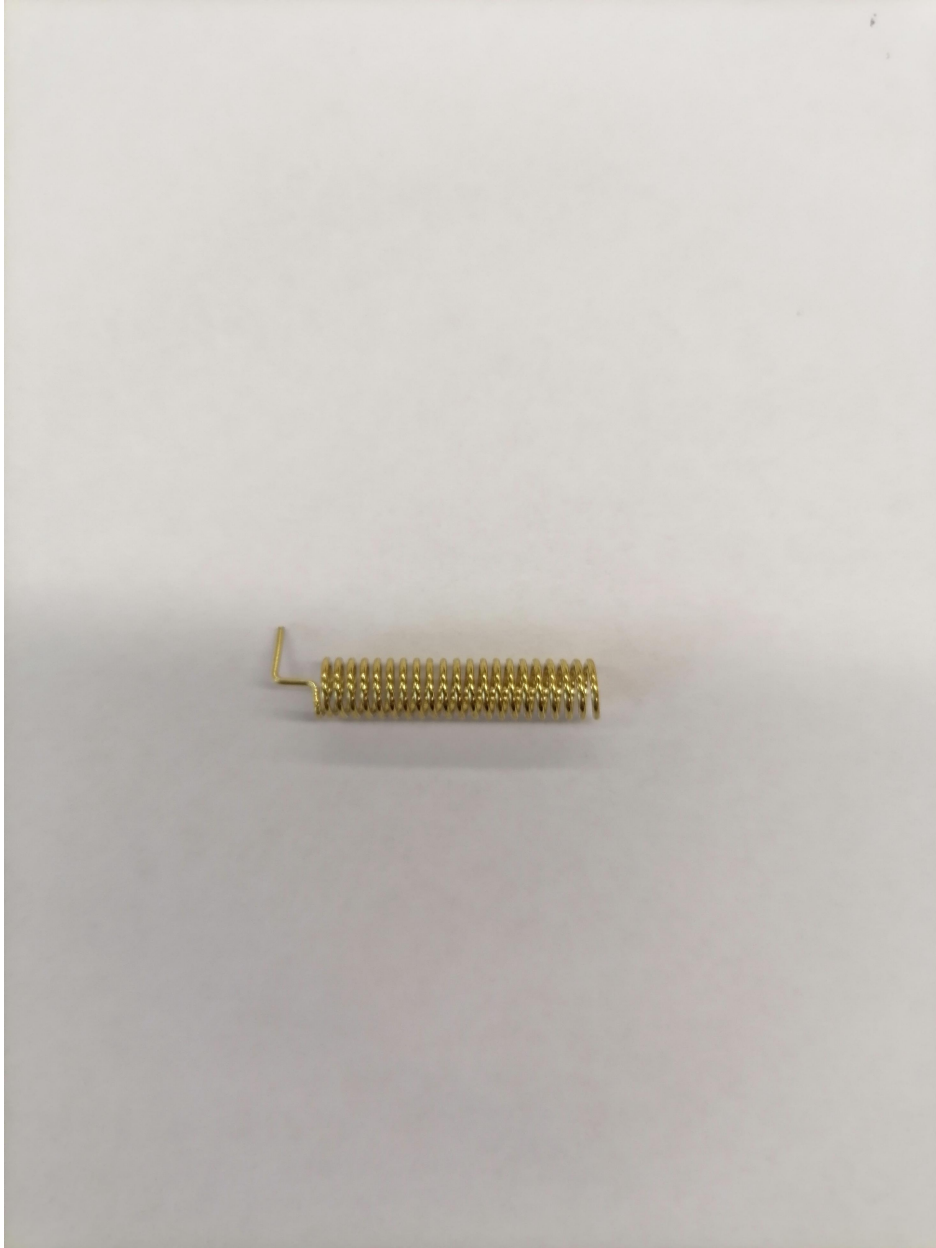

Above model: BW433SNX23-5W4-5, (Debug customizable)

(Customized customer intermediate connection line length customization, antenna shape customization)

\* Note: Due to the sensitive antenna function, please inform us for evaluation if there is any change in the peripheral institutions of the main body.

### 3. Electrical Specification

#### 3.1 Test Equipment

- A. VSWR and input impedance: Agilent 8753/E5071 Network Analyzer
- B. Antenna gain and efficiency: ETS three-dimensional anechoic chamber

#### 3.2 Test Setup

##### 3.2.1 Frequency Range

##### 3.2.2 VSWR

Step 1: The antenna is arranged on the customer provided test fixture.

Step 2: The VSWR of the antenna is measured via Agilent 8720/8753 Network Analyzer (see figure. )



Figure.1

##### 3.2.3 Radiation pattern and Gain

- A. The 3D chamber provides less than -40dB reflectivity from 800MHz to 6GHz and a 40cm diameter spherical quiet zone. The measurement results are calibrated using both dipoles and standard gain horns (see figure. 2).
- B. The antenna under tested is arranged in the turned table and a decoupling sleeve is used to reduce feed line radiation (see figure. 3).
- C. The measured results of the radiation patterns and antenna gain are obtained from the control system and showed on the monitor (see figure. 4 and 5).

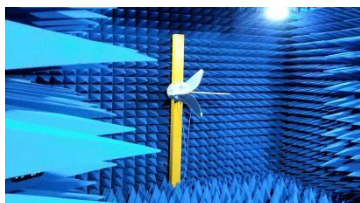

Figure.2

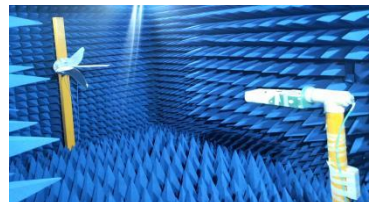

Figure.3



Figure.4

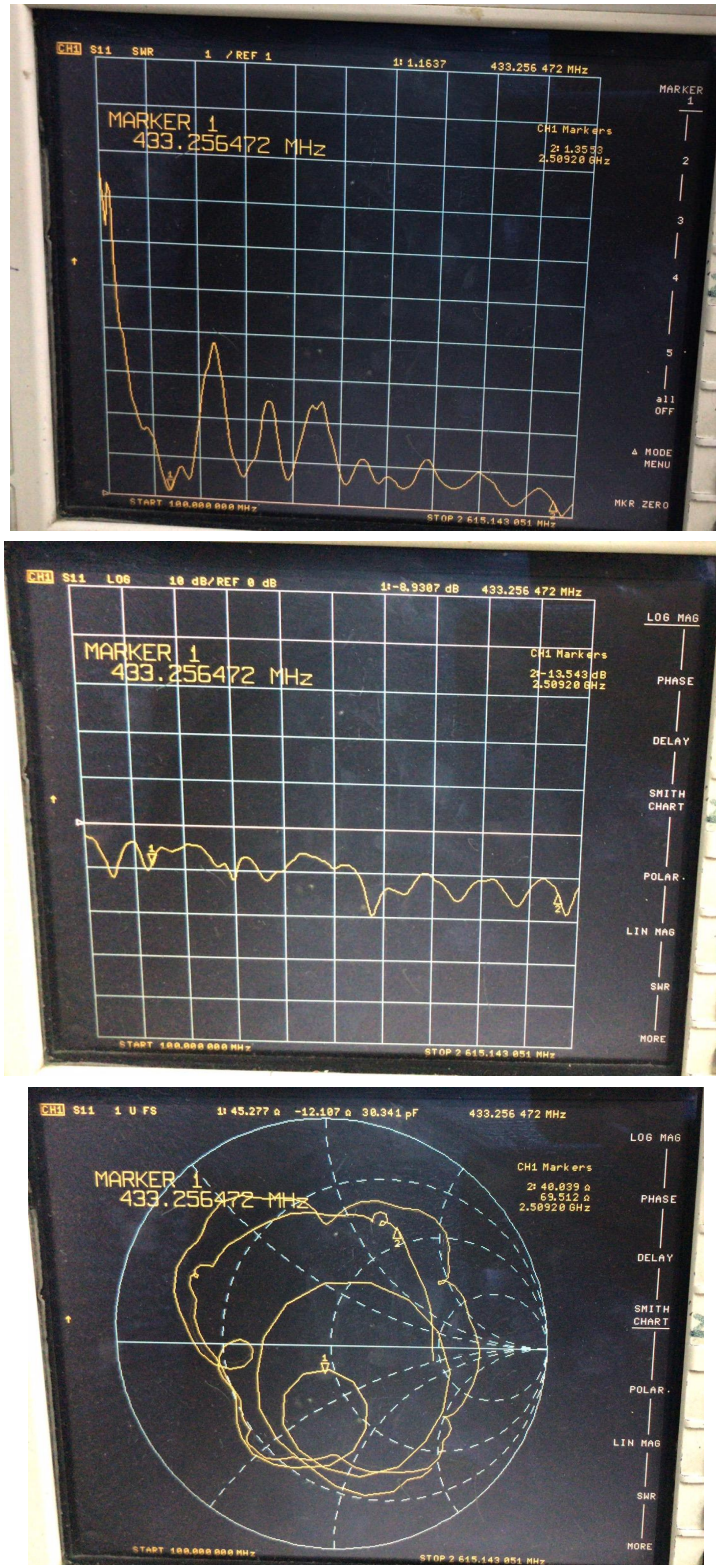

Figure.5

## 4. Performance Data

### 4.1. Passive data

VSWR/Return Loss/Smith Chart



\* Note: The above are measured data for reference only. Due to the sensitive antenna function, please inform us for evaluation if there is any change in the surrounding institutions of the main body.



## 2D

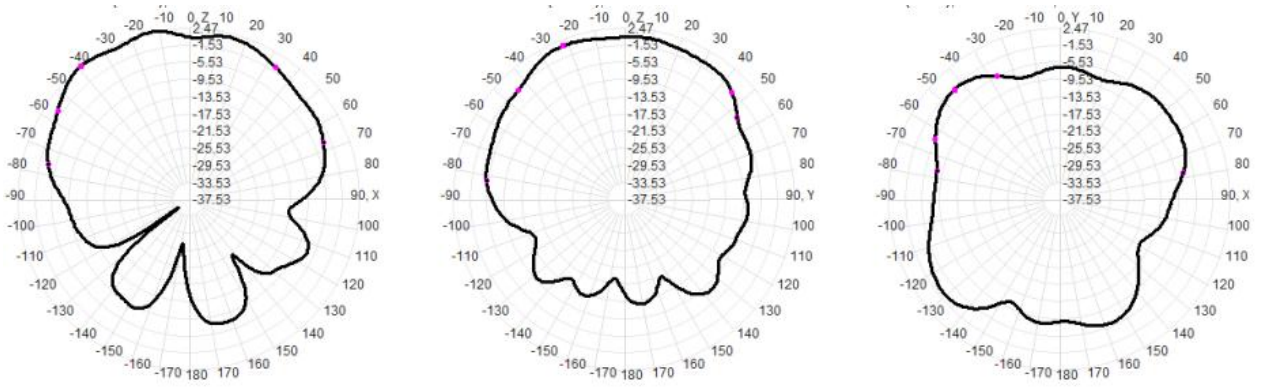

## 3D

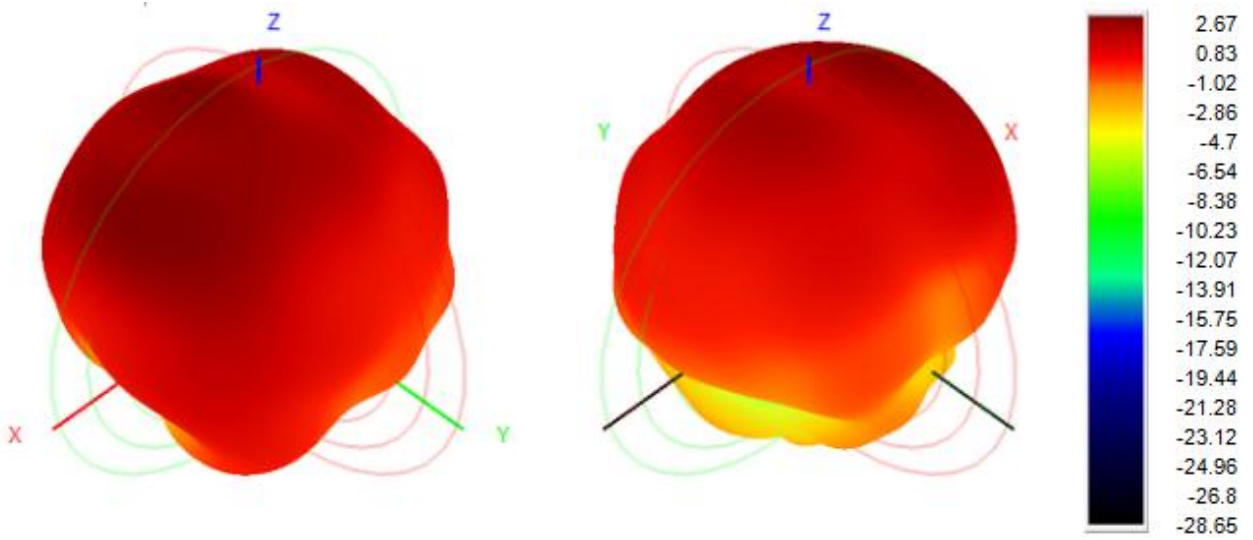

## 5. Mechanical Specification

### 5.1. Assembly Drawing

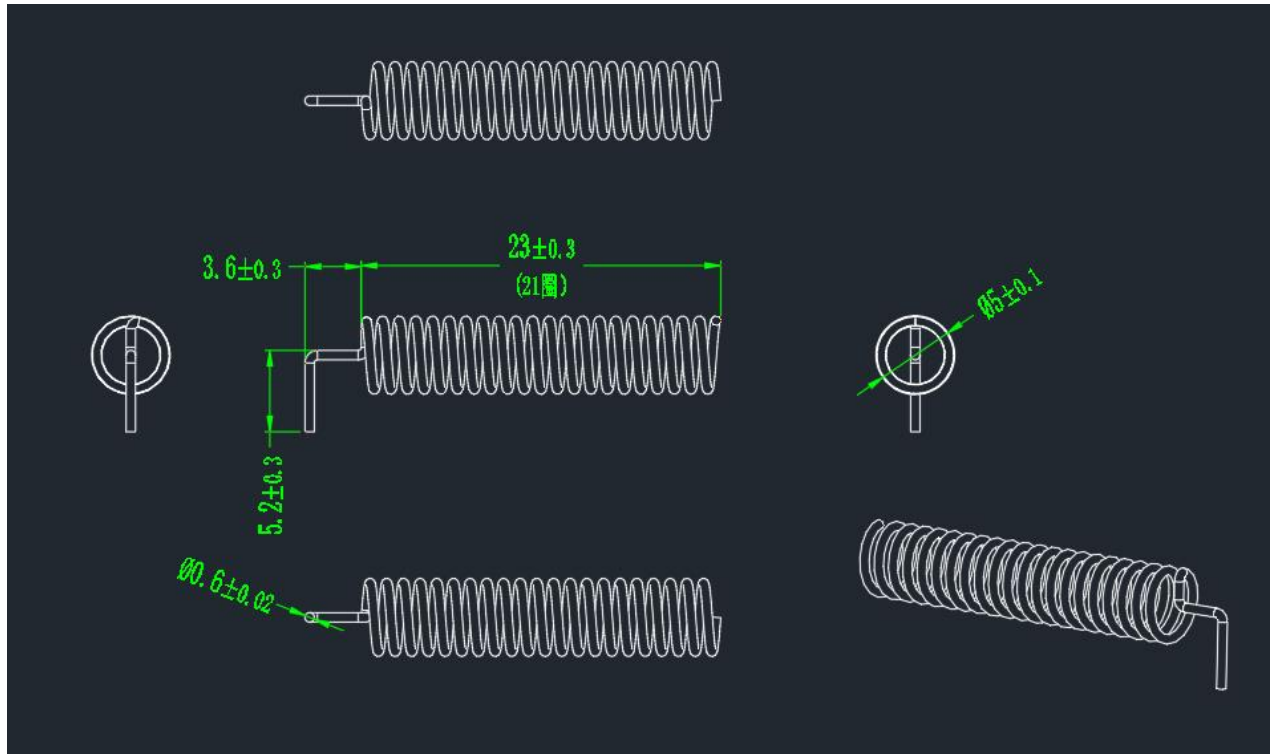

## 6. Disclaimer

In order to provide our users with better service, Shenzhen Bat Wireless Technology Co.,Ltd (hereinafter referred to as Bat Wireless) will try to present as detailed and accurate product information as possible in this manual. However, due to the timeliness of the manual content, Bat Wireless shall not absolutely guarantee the unlimited timeliness and applicability of the file. Bat Wireless has the right to update the manual content without further notice. To get the latest edition information, plsvisit the official website of Bat Wireless or contact our customer service staff. Thanks for your trust and support!