

**This device complies with Part 15 of the FCC Rules.  
Operation is subject to the following two conditions:  
(1) This device may not cause harmful interference,  
and (2) This device must accept any interference  
received, including interference that may cause  
undesired operation.**

**FCC ID: 2ATHHERA-EXTX**

REV.	Ref. Doc.	DESCRIPTION	DRAW	CHECK	DATE
A	N/A	NEW RELEASE	Leo Lu	Leo Lu	2021.05.06
B	N/A				

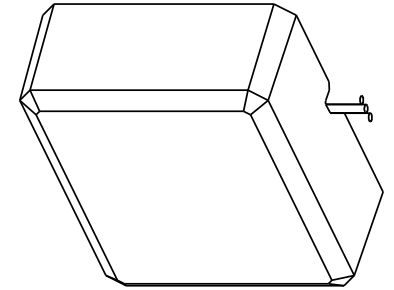
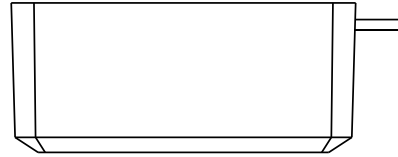

SCALE 0.800

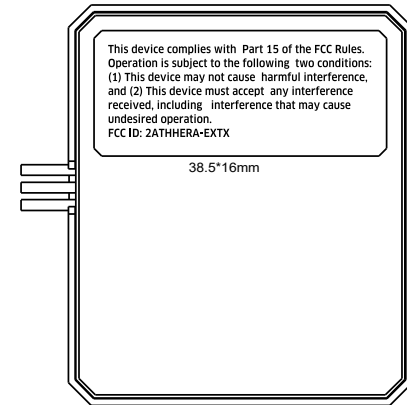
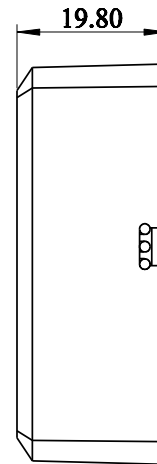
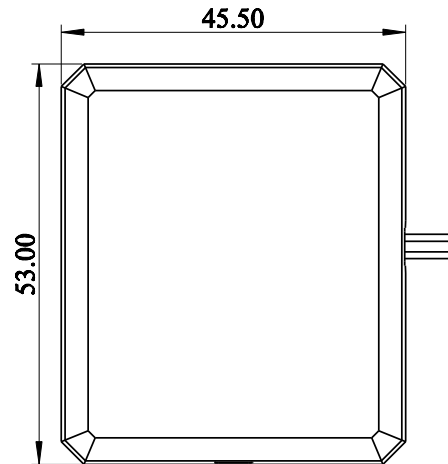
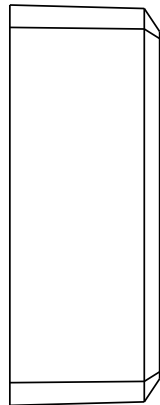

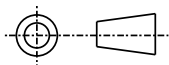
<b>LINEAR :</b> x.x ` 0.15 x.xx ` 0.1 <b>ANGULAR :</b> `0.5~	<b>TITLE :</b>	<b>0-ERA-EXTX</b>		
	<b>DWG.NO:</b>			
<b>PROJECTION:</b>  <b>THIRD ANGLE</b>	<b>MODEL :</b>		<b>MATERIAL:</b>	<b>*</b>
	<b>UNIT :</b>	<b>MM</b>	<b>REV. :</b>	<b>A</b>
	<b>SIZE :</b>	<b>A4</b>	<b>CHECK:</b>	<b>Leo Lu</b>
	<b>SCALE :</b>	<b>1.000</b>	<b>DRAW :</b>	<b>Leo Lu</b>
	<b>SHEET :</b>	<b>1 OF 1</b>	<b>DATE :</b>	<b>2021.05.06</b>