

TEST REPORT

Applicant: Quanzhou Skydroid Technology Co., Ltd.

Address of Applicant: 2nd Floor, Building A, Yucheng Base Fengze District, Quanzhou City, Fujian, China

Manufacturer/Factory: Quanzhou Skydroid Technology Co., Ltd.

Address of Manufacturer/Factory: 2nd Floor, Building A, Yucheng Base Fengze District, Quanzhou City, Fujian, China

Equipment Under Test (EUT)

Product Name: R10 Receiver

Model No.: R10, R10 PRO

FCC ID: 2ATGZQZYR10

Applicable standards: FCC CFR Title 47 Part 15 Subpart C Section 15.247

Date of sample receipt: July 02, 2021

Date of Test: July 02-20, 2021

Date of report issued: July 21, 2021

Test Result : PASS *

* In the configuration tested, the EUT complied with the standards specified above.

Authorized Signature:



Robinson Luo
Laboratory Manager

This results shown in this test report refer only to the sample(s) tested, this test report cannot be reproduced, except in full, without prior written permission of the company. The report would be invalid without specific stamp of test institute and the signatures of compiler and approver.

2 Version

Version No.	Date	Description
00	July 21, 2021	Original

Prepared By:

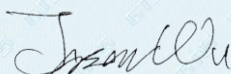

Date:

July 21, 2021

Project Engineer

Check By:

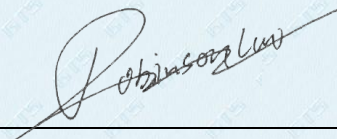

Date:

July 21, 2021

Reviewer

3 Contents

Page

1	COVER PAGE	1
2	VERSION	2
3	CONTENTS	3
4	TEST SUMMARY	4
4.1	MEASUREMENT UNCERTAINTY	4
5	GENERAL INFORMATION	5
5.1	GENERAL DESCRIPTION OF EUT	5
5.2	TEST MODE	7
5.3	TEST FACILITY	7
5.4	TEST LOCATION	7
5.5	DESCRIPTION OF SUPPORT UNITS	7
5.6	DEVIATION FROM STANDARDS.....	7
5.7	ABNORMALITIES FROM STANDARD CONDITIONS.....	7
5.8	ADDITIONAL INSTRUCTIONS.....	7
6	TEST INSTRUMENTS LIST	8
7	TEST RESULTS AND MEASUREMENT DATA	10
7.1	ANTENNA REQUIREMENT.....	10
7.2	CONDUCTED PEAK OUTPUT POWER.....	11
7.3	20dB EMISSION BANDWIDTH	12
7.4	CARRIER FREQUENCIES SEPARATION.....	13
7.5	HOPPING CHANNEL NUMBER	14
7.6	DWELL TIME	15
7.7	SPURIOUS EMISSION IN NON-RESTRICTED & RESTRICTED BANDS.....	16
7.7.1	Conducted Emission Method	16
7.7.2	Radiated Emission Method	17
8	TEST SETUP PHOTO	27
9	EUT CONSTRUCTIONAL DETAILS.....	27

4 Test Summary

Test Item	Section	Result
Antenna Requirement	15.203/15.247 (c)	Pass
AC Power Line Conducted Emission	15.207	N/A
Conducted Peak Output Power	15.247 (b)(1)	Pass
20dB Occupied Bandwidth	15.247 (a)(1)	Pass
Carrier Frequencies Separation	15.247 (a)(1)	Pass
Hopping Channel Number	15.247 (a)(1)	Pass
Dwell Time	15.247 (a)(1)	Pass
Pseudorandom Frequency Hopping Sequence	15.247(b)(4)	Pass
Radiated Emission	15.205/15.209	Pass
Band Edge	15.247(d)	Pass

Pass: The EUT complies with the essential requirements in the standard.

Remark : Test according to ANSI C63.10:2013.

4.1 Measurement Uncertainty

Test Item	Frequency Range	Measurement Uncertainty	Notes
Radiated Emission	30MHz-200MHz	3.8039dB	(1)
Radiated Emission	200MHz-1GHz	3.9679dB	(1)
Radiated Emission	1GHz-18GHz	4.29dB	(1)
Radiated Emission	18GHz-40GHz	3.30dB	(1)
AC Power Line Conducted Emission	0.15MHz ~ 30MHz	3.44dB	(1)

Note (1): The measurement uncertainty is for coverage factor of k=2 and a level of confidence of 95%.

5 General Information

5.1 General Description of EUT

Product Name:	R10 Receiver
Model No.:	R10, R10 PRO
Test Model No.:	R10
Remark: All above models are identical in the same PCB layout, interior structure and electrical circuits. The differences are appearance color and model name for commercial purpose.	
Serial No.:	2021R10F1880
Hardware version:	V1.0
Software version:	V1.0
Test sample(s) ID:	GTS202107000021-1
Sample(s) Status	Engineer sample
Operation Frequency:	2420MHz~2480MHz
Channel numbers:	31
Channel separation:	2MHz
Modulation technology:	GFSK
Antenna Type:	External antenna
Antenna gain:	ANT1/2: 2.0dBi(Max)
Power supply:	DC 5V

Operation Frequency of each channel							
Channel	Frequency (MHz)	Channel	Frequency (MHz)	Channel	Frequency (MHz)	Channel	Frequency (MHz)
1	2420	9	2436	17	2452	25	2468
2	2422	10	2438	18	2454	26	2470
3	2424	11	2440	19	2456	27	2472
4	2426	12	2442	20	2458	28	2474
5	2428	13	2444	21	2460	29	2476
6	2430	14	2446	22	2462	30	2478
7	2432	15	2448	23	2464	31	2480
8	2434	16	2450	24	2466		

In section 15.31(m), regards to the operating frequency range over 10 MHz, the Lowest frequency, the middle frequency, and the highest frequency of channel were selected to perform the test, and the selected channel see below:

Channel	Frequency
The lowest channel	2420MHz
The middle channel	2440MHz
The Highest channel	2480MHz

5.2 Test mode

Transmitting mode	Keep the EUT in transmitting mode.
Remark: During the test, the test voltage was tuned from 85% to 115% of the nominal rated supply voltage, and found that the worst case was under the nominal rated supply condition. So the report just shows that condition's data. New battery is used during all test.	

5.3 Test Facility

<p>The test facility is recognized, certified, or accredited by the following organizations:</p> <ul style="list-style-type: none">● FCC—Registration No.: 381383 Designation Number: CN5029 Global United Technology Services Co., Ltd., Shenzhen EMC Laboratory has been registered and fully described in a report filed with the (FCC) Federal Communications Commission. The acceptance letter from the FCC is maintained in files.● IC —Registration No.: 9079A CAB identifier: CN0091 The 3m Semi-anechoic chamber of Global United Technology Services Co., Ltd. has been registered by Certification and Engineering Bureau of Industry Canada for radio equipment testing● NVLAP (LAB CODE:600179-0) Global United Technology Services Co., Ltd., is accredited by the National Voluntary Laboratory Accreditation Program (NVLAP).
--

5.4 Test Location

All other tests were performed at:
Global United Technology Services Co., Ltd. Address: No. 123-128, Tower A, Jinyuan Business Building, No.2, Laodong Industrial Zone, Xixiang Road, Baoan District, Shenzhen, Guangdong, China 518102 Tel: 0755-27798480 Fax: 0755-27798960

5.5 Description of Support Units

None.

5.6 Deviation from Standards

None.

5.7 Abnormalities from Standard Conditions

None.

5.8 Additional Instructions

Software (Used for test) from client
Built-in by manufacturer, power set default.

6 Test Instruments list

Radiated Emission:						
Item	Test Equipment	Manufacturer	Model No.	Inventory No.	Cal.Date (mm-dd-yy)	Cal.Due date (mm-dd-yy)
1	3m Semi- Anechoic Chamber	ZhongYu Electron	9.2(L)*6.2(W)* 6.4(H)	GTS250	July. 02 2020	July. 01 2025
2	Control Room	ZhongYu Electron	6.2(L)*2.5(W)* 2.4(H)	GTS251	N/A	N/A
3	EMI Test Receiver	Rohde & Schwarz	ESU26	GTS203	June. 24 2021	June. 23 2022
4	BiConiLog Antenna	SCHWARZBECK MESS-ELEKTRONIK	VULB9163	GTS214	June. 24 2021	June. 23 2022
5	Double -ridged waveguide horn	SCHWARZBECK MESS-ELEKTRONIK	BBHA 9120 D	GTS208	June. 24 2021	June. 23 2022
6	Horn Antenna	ETS-LINDGREN	3160	GTS217	June. 24 2021	June. 23 2022
7	EMI Test Software	AUDIX	E3	N/A	N/A	N/A
8	Coaxial Cable	GTS	N/A	GTS213	June. 24 2021	June. 23 2022
9	Coaxial Cable	GTS	N/A	GTS211	June. 24 2021	June. 23 2022
10	Coaxial cable	GTS	N/A	GTS210	June. 24 2021	June. 23 2022
11	Coaxial Cable	GTS	N/A	GTS212	June. 24 2021	June. 23 2022
12	Amplifier(100kHz-3GHz)	HP	8347A	GTS204	June. 24 2021	June. 23 2022
13	Amplifier(2GHz-20GHz)	HP	84722A	GTS206	June. 24 2021	June. 23 2022
14	Amplifier (18-26GHz)	Rohde & Schwarz	AFS33-18002 650-30-8P-44	GTS218	June. 24 2021	June. 23 2022
15	Band filter	Amindeon	82346	GTS219	June. 24 2021	June. 23 2022
16	Power Meter	Anritsu	ML2495A	GTS540	June. 24 2021	June. 23 2022
17	Power Sensor	Anritsu	MA2411B	GTS541	June. 24 2021	June. 23 2022
18	Wideband Radio Communication Tester	Rohde & Schwarz	CMW500	GTS575	June. 24 2021	June. 23 2022
19	Splitter	Agilent	11636B	GTS237	June. 24 2021	June. 23 2022
20	Loop Antenna	ZHINAN	ZN30900A	GTS534	June. 24 2021	June. 23 2022
21	Breitband hornantenne	SCHWARZBECK	BBHA 9170	GTS579	Oct. 18 2020	Oct. 17 2021
22	Amplifier	TDK	PA-02-02	GTS574	Oct. 18 2020	Oct. 17 2021
23	Amplifier	TDK	PA-02-03	GTS576	Oct. 18 2020	Oct. 17 2021
24	PSA Series Spectrum Analyzer	Rohde & Schwarz	FSP	GTS578	June. 24 2021	June. 23 2022

RF Conducted Test:						
Item	Test Equipment	Manufacturer	Model No.	Serial No.	Cal.Date (mm-dd-yy)	Cal.Due date (mm-dd-yy)
1	MXA Signal Analyzer	Agilent	N9020A	GTS566	June. 24 2021	June. 23 2022
2	EMI Test Receiver	R&S	ESCI 7	GTS552	June. 24 2021	June. 23 2022
3	Spectrum Analyzer	Agilent	E4440A	GTS533	June. 24 2021	June. 23 2022
4	MXG vector Signal Generator	Agilent	N5182A	GTS567	June. 24 2021	June. 23 2022
5	ESG Analog Signal Generator	Agilent	E4428C	GTS568	June. 24 2021	June. 23 2022
6	USB RF Power Sensor	DARE	RPR3006W	GTS569	June. 24 2021	June. 23 2022
7	RF Switch Box	Shongyi	RFSW3003328	GTS571	June. 24 2021	June. 23 2022
8	Programmable Constant Temp & Humi Test Chamber	WEWON	WHTH-150L-40-880	GTS572	June. 24 2021	June. 23 2022

General used equipment:						
Item	Test Equipment	Manufacturer	Model No.	Inventory No.	Cal.Date (mm-dd-yy)	Cal.Due date (mm-dd-yy)
1	Humidity/ Temperature Indicator	KTJ	TA328	GTS243	June. 24 2021	June. 23 2022
2	Barometer	ChangChun	DYM3	GTS255	June. 24 2021	June. 23 2022

7 Test results and Measurement Data

7.1 Antenna requirement

Standard requirement:	FCC Part15 C Section 15.203 /247(c)
<p>15.203 requirement:</p> <p>An intentional radiator shall be designed to ensure that no antenna other than that furnished by the responsible party shall be used with the device. The use of a permanently attached antenna or of an antenna that uses a unique coupling to the intentional radiator, the manufacturer may design the unit so that a broken antenna can be replaced by the user, but the use of a standard antenna jack or electrical connector is prohibited.</p> <p>15.247(c) (1)(i) requirement:</p> <p>(i) Systems operating in the 2400-2483.5 MHz band that is used exclusively for fixed. Point-to-point operations may employ transmitting antennas with directional gain greater than 6dBi provided the maximum conducted output power of the intentional radiator is reduced by 1 dB for every 3 dB that the directional gain of the antenna exceeds 6dBi.</p>	
EUT Antenna:	
<p><i>The antenna is external antenna, the best case gain of the antenna is 2dBi, reference to the appendix II for details.</i></p>	

7.2 Conducted Peak Output Power

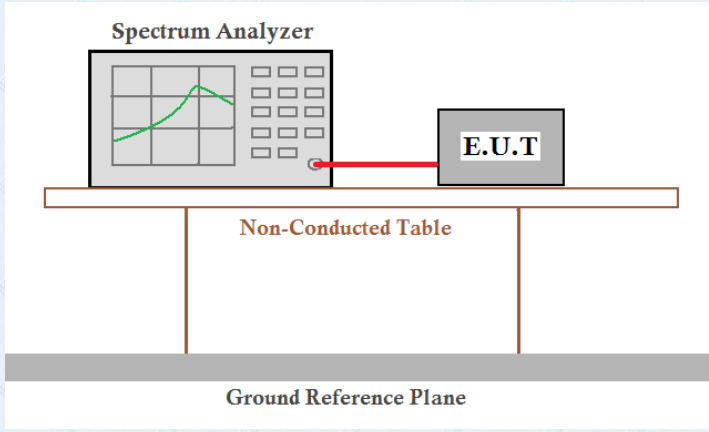
Test Requirement:	FCC Part15 C Section 15.247 (b)(1)
Test Method:	ANSI C63.10:2013
Limit:	20.97dBm
Test setup:	 <p>The diagram illustrates the test setup. A Spectrum Analyzer is connected to an E.U.T. (Equipment Under Test) via a red cable. Both are placed on a Non-Conducted Table, which sits on a Ground Reference Plane.</p>
Test Instruments:	Refer to section 6.0 for details
Test mode:	Refer to section 5.2 for details
Test results:	Pass

Measurement Data: The detailed test data see Appendix for 2.4G.

7.3 20dB Emission Bandwidth

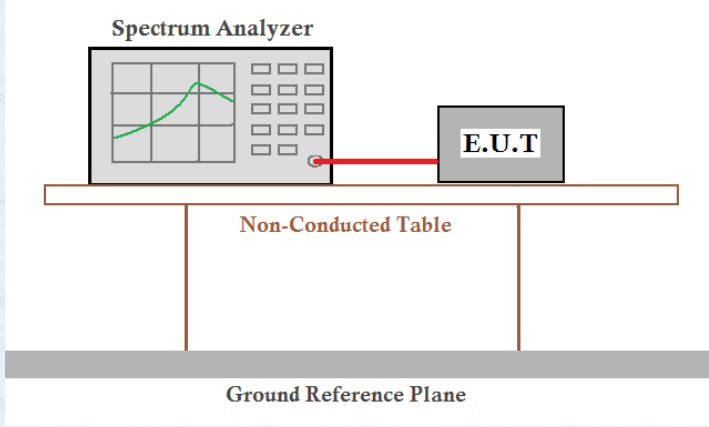
Test Requirement:	FCC Part15 C Section 15.247 (a)(1)
Test Method:	ANSI C63.10:2013
Limit:	N/A
Test setup:	 <p>The diagram illustrates the test setup. A Spectrum Analyzer is connected to an E.U.T. (Equipment Under Test) via a red cable. Both are placed on a Non-Conducted Table, which sits on a Ground Reference Plane.</p>
Test Instruments:	Refer to section 6.0 for details
Test mode:	Refer to section 5.2 for details
Test results:	Pass

Measurement Data: The detailed test data see Appendix for 2.4G.

7.4 Carrier Frequencies Separation

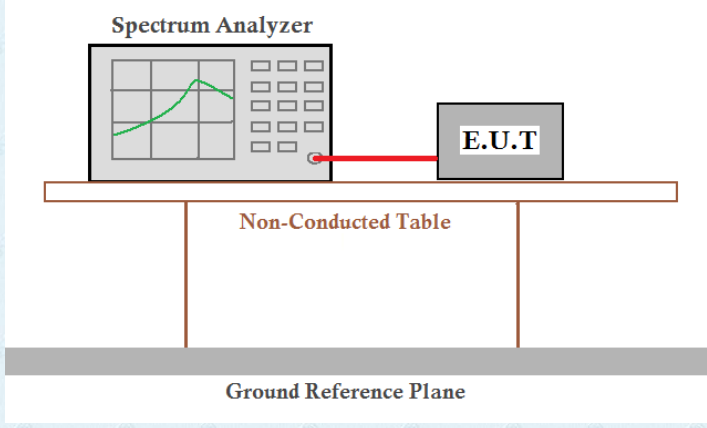
Test Requirement:	FCC Part15 C Section 15.247 (a)(1)
Test Method:	ANSI C63.10:2013
Receiver setup:	RBW=100KHz, VBW=300KHz, detector=Peak
Limit:	0.025MHz or 2/3 of the 20dB bandwidth (whichever is greater)
Test setup:	 <p>The diagram illustrates the test setup. A Spectrum Analyzer is connected to an E.U.T. (Equipment Under Test) via a red cable. Both are placed on a Non-Conducted Table, which is supported by a Ground Reference Plane.</p>
Test Instruments:	Refer to section 6.0 for details
Test mode:	Refer to section 5.2 for details
Test results:	Pass

Measurement Data: The detailed test data see Appendix for 2.4G.

7.5 Hopping Channel Number

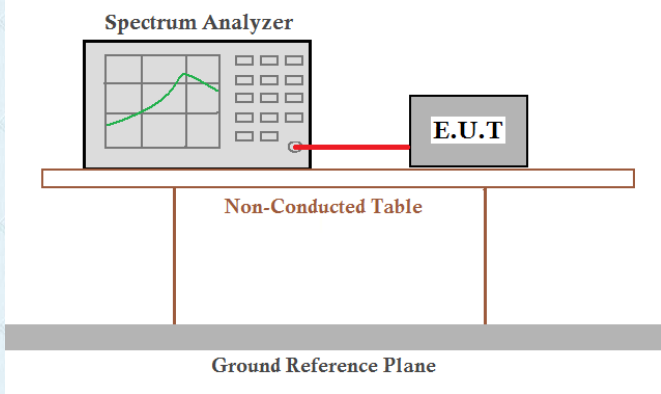
Test Requirement:	FCC Part15 C Section 15.247 (a)(1)
Test Method:	ANSI C63.10:2013
Receiver setup:	RBW=100kHz, VBW=300kHz, Frequency range=2400MHz-2483.5MHz, Detector=Peak
Limit:	15 channels
Test setup:	 <p>The diagram illustrates the test setup. A Spectrum Analyzer is connected to an E.U.T. (Equipment Under Test) via a red cable. Both are placed on a Non-Conducted Table, which is supported by a Ground Reference Plane.</p>
Test Instruments:	Refer to section 6.0 for details
Test mode:	Refer to section 5.2 for details
Test results:	Pass

Measurement Data: The detailed test data see Appendix for 2.4G.

7.6 Dwell Time

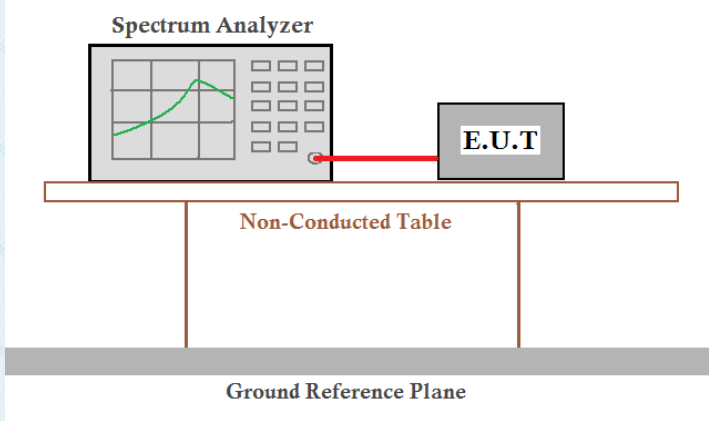
Test Requirement:	FCC Part15 C Section 15.247 (a)(1)
Test Method:	ANSI C63.10:2013
Receiver setup:	RBW=1MHz, VBW=1MHz, Span=0Hz, Detector=Peak
Limit:	0.4 Second
Test setup:	 <p>The diagram illustrates the test setup. A Spectrum Analyzer is connected to an E.U.T. (Equipment Under Test) via a red cable. Both are placed on a Non-Conducted Table, which is supported by a Ground Reference Plane.</p>
Test Instruments:	Refer to section 6.0 for details
Test mode:	Refer to section 5.2 for details
Test results:	Pass

Measurement Data: The detailed test data see Appendix for 2.4G.

7.7 Spurious Emission in Non-restricted & restricted Bands

7.7.1 Conducted Emission Method

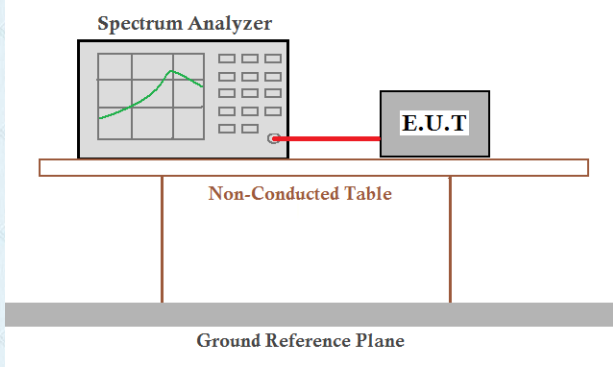
Test Requirement:	FCC Part15 C Section 15.247 (d)
Test Method:	ANSI C63.10:2013
Receiver setup:	RBW=100kHz, VBW=300kHz, Detector=Peak
Limit:	In any 100 kHz bandwidth outside the frequency band in which the spread spectrum intentional radiator is operating, the radio frequency power that is produced by the intentional radiator shall be at least 20 dB below that in the 100 kHz bandwidth within the band that contains the highest level of the desired power, based on either an RF conducted or a radiated measurement.
Test setup:	 <p>The diagram illustrates the test setup. A Spectrum Analyzer is connected to an E.U.T. (Equipment Under Test) via a red cable. Both are placed on a Non-Conducted Table, which sits on a Ground Reference Plane.</p>
Test Instruments:	Refer to section6.0 for details
Test mode:	Refer to section 5.2 for details
Test results:	Pass

Measurement Data: The detailed test data see Appendix for 2.4G.

7.7.2 Radiated Emission Method

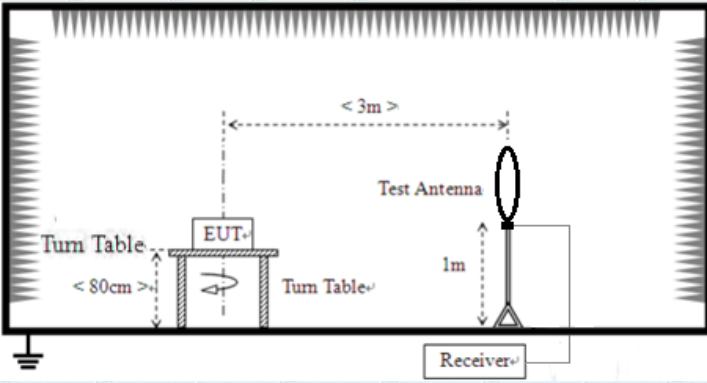
Test Requirement:	FCC Part15 C Section 15.209				
Test Method:	ANSI C63.10:2013				
Test Frequency Range:	9kHz to 25GHz				
Test site:	Measurement Distance: 3m				
Receiver setup:	Frequency	Detector	RBW	VBW	Value
	9KHz-150KHz	Quasi-peak	200Hz	600Hz	Quasi-peak
	150KHz-30MHz	Quasi-peak	9KHz	30KHz	Quasi-peak
	30MHz-1GHz	Quasi-peak	120KHz	300KHz	Quasi-peak
	Above 1GHz	Peak	1MHz	3MHz	Peak
Peak		1MHz	10Hz	Average	
Limit: (Spurious Emissions)	Frequency	Limit (uV/m)	Value	Measurement Distance	
	0.009MHz-0.490MHz	2400/F(KHz)	QP	300m	
	0.490MHz-1.705MHz	24000/F(KHz)	QP	300m	
	1.705MHz-30MHz	30	QP	30m	
	30MHz-88MHz	100	QP	3m	
	88MHz-216MHz	150	QP		
	216MHz-960MHz	200	QP		
	960MHz-1GHz	500	QP		
	Above 1GHz	500	Average		
5000		Peak			
Test setup:	Below 30MHz				
	 <p>Below 1GHz</p>				

	<p>Above 1GHz</p>						
<p>Test Procedure:</p>	<ol style="list-style-type: none"> 1. The EUT was placed on the top of a rotating table (0.8 meters for below 1GHz and 1.5meters for above 1GHz) above the ground at a 3 meter camber. The table was rotated 360 degrees to determine the position of the highest radiation. 2. The EUT was set 3 meters away from the interference-receiving antenna, which was mounted on the top of a variable-height antenna tower. 3. The antenna height is varied from one meter to four meters above the ground to determine the maximum value of the field strength. Both horizontal and vertical polarizations of the antenna are set to make the measurement. 4. For each suspected emission, the EUT was arranged to its worst case and then the antenna was tuned to heights from 1 meter to 4 meters and the rota table was turned from 0 degrees to 360 degrees to find the maximum reading. 5. The test-receiver system was set to Peak Detect Function and Specified Bandwidth with Maximum Hold Mode. 6. If the emission level of the EUT in peak mode was 10dB lower than the limit specified, then testing could be stopped and the peak values of the EUT would be reported. Otherwise the emissions that did not have 10dB margin would be re-tested one by one using peak, quasi-peak or average method as specified and then reported in a data sheet. 						
<p>Test Instruments:</p>	<p>Refer to section 5.8 for details</p>						
<p>Test mode:</p>	<p>Refer to section 5.2 for details</p>						
<p>Temp. / Hum.</p>	<table border="1"> <tr> <td>Temp.:</td> <td>25 °C</td> <td>Humid.:</td> <td>52%</td> <td>Press.:</td> <td>1 012mbar</td> </tr> </table>	Temp.:	25 °C	Humid.:	52%	Press.:	1 012mbar
Temp.:	25 °C	Humid.:	52%	Press.:	1 012mbar		

Test results:	Pass
---------------	------

Remark:

1. *Pre-scan all kind of the place mode (X-axis, Y-axis, Z-axis), and found the Y-axis which it is worse case.*

Measurement data:

■ **Below 30MHz**

The low frequency, which started from 9 kHz to 30 MHz, was pre-scanned and the result which was 20 dB lower than the limit line per 15.31(o) was not reported.

■ 30MHz ~ 1GHz

Pre-scan all test modes, found worst case at 2480MHz, and so only show the test result of 2480MHz

Horizontal:

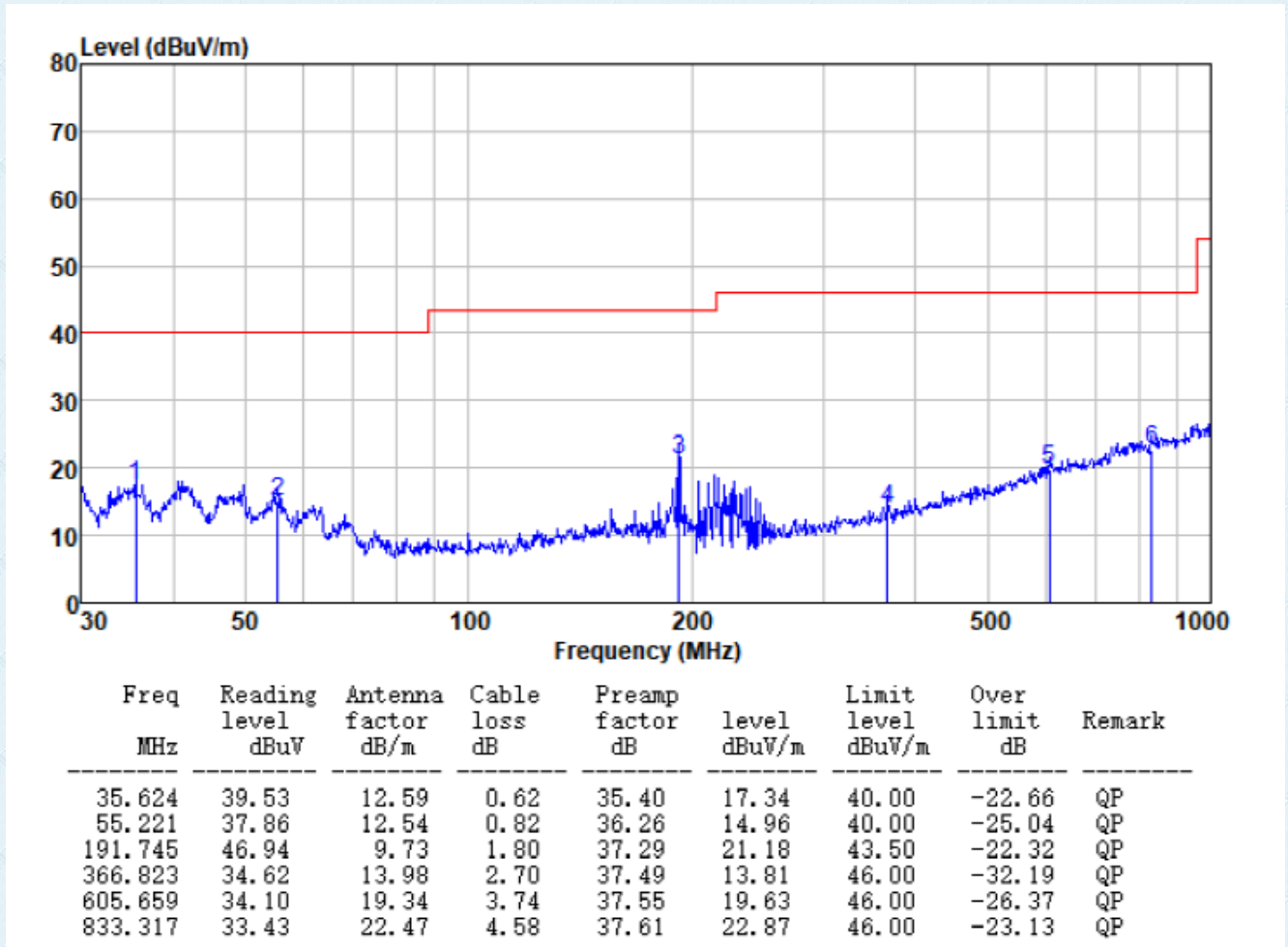

Vertical:

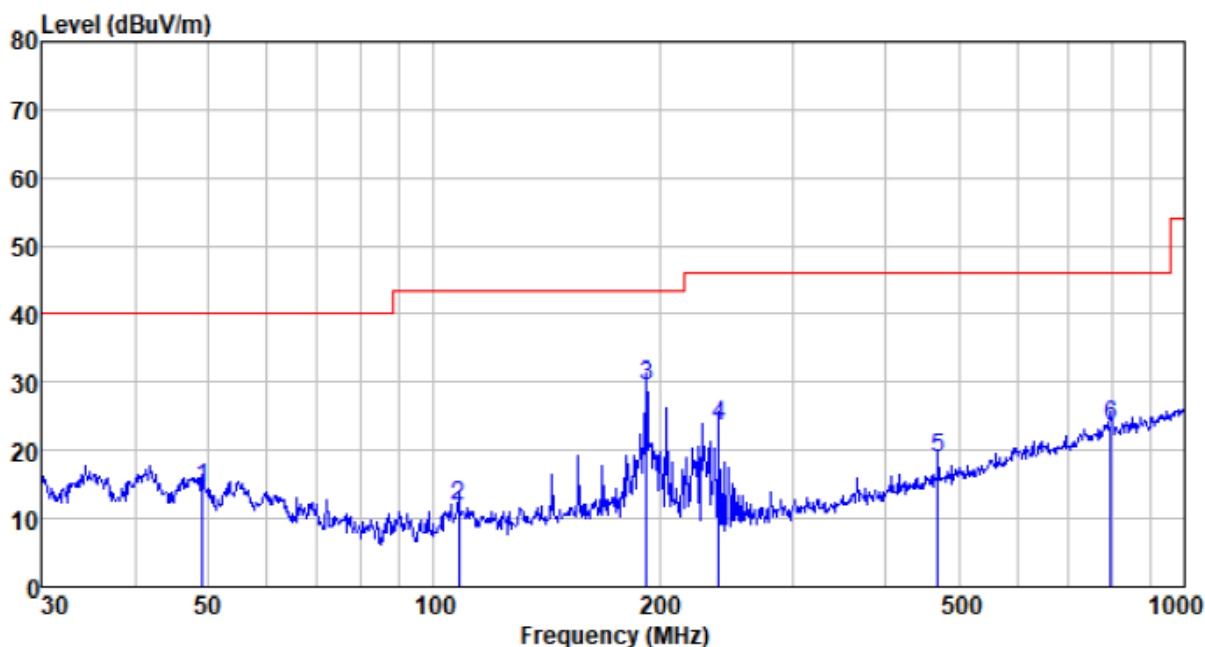

Freq MHz	Reading level dBuV	Antenna factor dB/m	Cable loss dB	Preamp factor dB	level dBuV/m	Limit level dBuV/m	Over limit dB	Remark
49.187	36.86	13.03	0.76	36.14	14.51	40.00	-25.49	QP
107.888	37.48	9.80	1.26	36.79	11.75	43.50	-31.75	QP
191.745	55.19	9.73	1.80	37.29	29.43	43.50	-14.07	QP
239.987	48.43	10.45	2.07	37.37	23.58	46.00	-22.42	QP
468.876	36.97	16.24	3.18	37.51	18.88	46.00	-27.12	QP
796.183	34.56	22.19	4.45	37.62	23.58	46.00	-22.42	QP

- Above 1GHz
- Unwanted Emissions in Restricted Frequency Bands

Test channel:	Lowest
---------------	--------

Peak value:

Frequency (MHz)	Read Level (dBuV)	Antenna Factor (dB/m)	Cable Loss (dB)	Preamp Factor (dB)	Level (dBuV/m)	Limit Line (dBuV/m)	Over Limit (dB)	polarization
4840.00	35.78	31.78	8.60	32.09	44.07	74.00	-29.93	Vertical
7260.00	30.82	36.15	11.65	32.00	46.62	74.00	-27.38	Vertical
9680.00	30.57	37.95	14.14	31.62	51.04	74.00	-22.96	Vertical
12100.00	*					74.00		Vertical
14520.00	*					74.00		Vertical
4840.00	39.76	31.78	8.60	32.09	48.05	74.00	-25.95	Horizontal
7260.00	32.44	36.15	11.65	32.00	48.24	74.00	-25.76	Horizontal
9680.00	29.85	37.95	14.14	31.62	50.32	74.00	-23.68	Horizontal
12100.00	*					74.00		Horizontal
14520.00	*					74.00		Horizontal

Average value:

Frequency (MHz)	Read Level (dBuV)	Antenna Factor (dB/m)	Cable Loss (dB)	Preamp Factor (dB)	Level (dBuV/m)	Limit Line (dBuV/m)	Over Limit (dB)	polarization
4840.00	24.89	31.78	8.60	32.09	33.18	54.00	-20.82	Vertical
7260.00	19.68	36.15	11.65	32.00	35.48	54.00	-18.52	Vertical
9680.00	18.85	37.95	14.14	31.62	39.32	54.00	-14.68	Vertical
12100.00	*					54.00		Vertical
14520.00	*					54.00		Vertical
4840.00	28.94	31.78	8.60	32.09	37.23	54.00	-16.77	Horizontal
7260.00	21.75	36.15	11.65	32.00	37.55	54.00	-16.45	Horizontal
9680.00	18.45	37.95	14.14	31.62	38.92	54.00	-15.08	Horizontal
12100.00	*					54.00		Horizontal
14520.00	*					54.00		Horizontal

Test channel:	Middle
---------------	--------

Peak value:

Frequency (MHz)	Read Level (dBuV)	Antenna Factor (dB/m)	Cable Loss (dB)	Preamp Factor (dB)	Level (dBuV/m)	Limit Line (dBuV/m)	Over Limit (dB)	polarization
4880.00	36.12	31.85	8.67	32.12	44.52	74.00	-29.48	Vertical
7320.00	31.04	36.37	11.72	31.89	47.24	74.00	-26.76	Vertical
9760.00	30.77	38.35	14.25	31.62	51.75	74.00	-22.25	Vertical
12200.00	*					74.00		Vertical
14640.00	*					74.00		Vertical
4880.00	40.16	31.85	8.67	32.12	48.56	74.00	-25.44	Horizontal
7320.00	32.69	36.37	11.72	31.89	48.89	74.00	-25.11	Horizontal
9760.00	30.08	38.35	14.25	31.62	51.06	74.00	-22.94	Horizontal
12200.00	*					74.00		Horizontal
14640.00	*					74.00		Horizontal

Average value:

Frequency (MHz)	Read Level (dBuV)	Antenna Factor (dB/m)	Cable Loss (dB)	Preamp Factor (dB)	Level (dBuV/m)	Limit Line (dBuV/m)	Over Limit (dB)	polarization
4880.00	25.16	31.85	8.67	32.12	33.56	54.00	-20.44	Vertical
7320.00	19.87	36.37	11.72	31.89	36.07	54.00	-17.93	Vertical
9760.00	19.02	38.35	14.25	31.62	40.00	54.00	-14.00	Vertical
12200.00	*					54.00		Vertical
14640.00	*					54.00		Vertical
4880.00	29.26	31.85	8.67	32.12	37.66	54.00	-16.34	Horizontal
7320.00	21.96	36.37	11.72	31.89	38.16	54.00	-15.84	Horizontal
9760.00	18.65	38.35	14.25	31.62	39.63	54.00	-14.37	Horizontal
12200.00	*					54.00		Horizontal
14640.00	*					54.00		Horizontal

Test channel:	Highest
---------------	---------

Peak value:

Frequency (MHz)	Read Level (dBuV)	Antenna Factor (dB/m)	Cable Loss (dB)	Preamp Factor (dB)	Level (dBuV/m)	Limit Line (dBuV/m)	Over Limit (dB)	polarization
4960.00	36.30	31.93	8.73	32.16	44.80	74.00	-29.20	Vertical
7440.00	31.17	36.59	11.79	31.78	47.77	74.00	-26.23	Vertical
9920.00	30.88	38.81	14.38	31.88	52.19	74.00	-21.81	Vertical
12400.00	*					74.00		Vertical
14880.00	*					74.00		Vertical
4960.00	40.38	31.93	8.73	32.16	48.88	74.00	-25.12	Horizontal
7440.00	32.83	36.59	11.79	31.78	49.43	74.00	-24.57	Horizontal
9920.00	30.20	38.81	14.38	31.88	51.51	74.00	-22.49	Horizontal
12400.00	*					74.00		Horizontal
14880.00	*					74.00		Horizontal

Average value:

Frequency (MHz)	Read Level (dBuV)	Antenna Factor (dB/m)	Cable Loss (dB)	Preamp Factor (dB)	Level (dBuV/m)	Limit Line (dBuV/m)	Over Limit (dB)	polarization
4960.00	25.36	31.93	8.73	32.16	33.86	54.00	-20.14	Vertical
7440.00	20.00	36.59	11.79	31.78	36.60	54.00	-17.40	Vertical
9920.00	19.14	38.81	14.38	31.88	40.45	54.00	-13.55	Vertical
12400.00	*					54.00		Vertical
14880.00	*					54.00		Vertical
4960.00	29.49	31.93	8.73	32.16	37.99	54.00	-16.01	Horizontal
7440.00	22.11	36.59	11.79	31.78	38.71	54.00	-15.29	Horizontal
9920.00	18.79	38.81	14.38	31.88	40.10	54.00	-13.90	Horizontal
12400.00	*					54.00		Horizontal
14880.00	*					54.00		Horizontal

Remarks:

1. Final Level = Receiver Read level + Antenna Factor + Cable Loss – Pre-amplifier Factor
2. The emission levels of other frequencies are very lower than the limit and not show in test report.

■ **Unwanted Emissions in Non-restricted Frequency Bands**

Test channel:	Lowest
---------------	--------

Peak value:

Frequency (MHz)	Read Level (dBuV)	Antenna Factor (dB/m)	Cable Loss (dB)	Preamp Factor (dB)	Level (dBuV/m)	Limit Line (dBuV/m)	Over Limit (dB)	Polarization
2310.00	44.86	27.91	5.30	24.64	53.43	74.00	-20.57	Horizontal
2390.00	48.94	27.59	5.38	24.71	57.20	74.00	-16.80	Horizontal
2400.00	50.67	27.41	5.39	24.72	58.75	74.00	-15.25	Horizontal
2310.00	45.60	27.91	5.30	24.64	54.17	74.00	-19.83	Vertical
2390.00	50.19	27.59	5.38	24.71	58.45	74.00	-15.56	Vertical
2400.00	51.70	27.41	5.39	24.72	59.78	74.00	-14.22	Vertical

Average value:

Frequency (MHz)	Read Level (dBuV)	Antenna Factor (dB/m)	Cable Loss (dB)	Preamp Factor (dB)	Level (dBuV/m)	Limit Line (dBuV/m)	Over Limit (dB)	Polarization
2310.00	34.97	27.91	5.30	24.64	43.54	54.00	-10.47	Horizontal
2390.00	36.32	27.59	5.38	24.71	44.58	54.00	-9.42	Horizontal
2400.00	37.53	27.41	5.39	24.72	45.61	54.00	-8.40	Horizontal
2310.00	35.05	27.91	5.30	24.64	43.62	54.00	-10.38	Vertical
2390.00	37.16	27.59	5.38	24.71	45.42	54.00	-8.58	Vertical
2400.00	38.22	27.41	5.39	24.72	46.30	54.00	-7.70	Vertical

Test channel:	Highest
---------------	---------

Peak value:

Frequency (MHz)	Read Level (dBuV)	Antenna Factor (dB/m)	Cable Loss (dB)	Preamp Factor (dB)	Level (dBuV/m)	Limit Line (dBuV/m)	Over Limit (dB)	Polarization
2483.50	47.20	27.53	5.47	24.80	55.40	74.00	-18.60	Horizontal
2500.00	46.00	27.55	5.49	24.86	54.18	74.00	-19.82	Horizontal
2483.50	48.38	27.53	5.47	24.80	56.58	74.00	-17.42	Vertical
2500.00	47.19	27.55	5.49	24.86	55.37	74.00	-18.63	Vertical

Average value:

Frequency (MHz)	Read Level (dBuV)	Antenna Factor (dB/m)	Cable Loss (dB)	Preamp Factor (dB)	Level (dBuV/m)	Limit Line (dBuV/m)	Over Limit (dB)	Polarization
2483.50	35.82	27.53	5.47	24.80	44.02	54.00	-9.98	Horizontal
2500.00	35.53	27.55	5.49	24.86	43.71	54.00	-10.29	Horizontal
2483.50	35.96	27.53	5.47	24.80	44.16	54.00	-9.84	Vertical
2500.00	35.62	27.55	5.49	24.86	43.80	54.00	-10.20	Vertical

Remarks:

1. Final Level = Receiver Read level + Antenna Factor + Cable Loss – Preamplifier Factor
2. The emission levels of other frequencies are very lower than the limit and not show in test report.
3. “*”, means this data is the too weak instrument of signal is unable to test.

8 Test Setup Photo

Reference to the **appendix I** for details.

9 EUT Constructional Details

Reference to the **appendix II** for details.

---End---