

# SKYDROID H16

## User Manual V1.0

### Attention

This product uses the following terms to classify the potential hazards that may be caused by improper operation.

Note: If not follow the instructions, it may cause property damage and minor injuries.

Note: If not follow the instructions, it may cause property damage, major accidents and serious injuries.

Warning: Misuse of this product may result in injury, damage or loss of property. Read the manual carefully before using this product. This item is not a toy. This item is intended for use by professional UAV operators and installers only. Donot use this product if you lack the knowledge and expertise to install and maintain UAV radio equipment. Do not use unapproved or unofficial components with this system. Operators must strictly follow the operation guides set forth in this manual. Skydroid does not accept any liability for the use or misuse of this product.

### Overview

#### 1: Product Features

(1) The H16 series uses the newest surging processor, equipped with an Android embedded system and advanced SDR technology, also with a super protocol stack to make the image clearer, lower latency, longer distance transmission, and stronger anti-interference. Wildly applied for drones, Robots, industrial controlled equipment, etc.

(2) Supports rich interfaces such as HDMI, RJ45, sensor interface, dual serial ports passthrough transmission, SBUS, aerial photography, FPV security, fire protection, power, mapping robot, border control, etc.

(3) IP67 design, based on waterproof, dust free and drop-resistant materials and structure to ensure its great using feel and durability

(4) H16 uses 7-inch FHD high-brightness display, 1800 nits brightness IPS LCD screen, which can be viewed clearly under the sun. Supports 1080P high-definition digital image transmission. The dual-antenna signals complement each other, with super-strong signals and ultra-long transmitting distances, combined with algorithm control and out-of-step frequency hopping algorithms, greatly increasing the ability to communicate with weak signals. So you don't need to worry about the flight distance during flight operations, just explore a wider scenery. H16's video transmission distance is around 5-10km, H16 Pro's video transmission distance is around 20-30KM.

(5) Integrated with high energy density lithium ion battery, 18w fast charging, can work for 8-15 hours after 2 hours of charging. The consistent survival thinking in the wilderness allows you to have no concerns about the reliability of our equipment.

(6) H16/H16 Pro supports rich interfaces such as HDMI, RJ45, sensor interface, dual serial port passthrough transmission, SBUS, etc. And supports many brands cameras, pan-tilts, pods and other video equipment. Provide development kit, SDK and technical support, support video suspension, support ground station of mainstream flight control, support QGC and wireless RTSP video stream sharing.

(7) The use of weather silica gel, frosted rubber, stainless steel, and aviation aluminum alloy makes the extreme operating feel, and also meets the harsh conditions of outdoor use of drones. H16 is dust-free and waterproof in the fuselage, control switches, and various peripheral interfaces. Protective measures such as splashing can ensure stable and smooth operation of the equipment in harsh environments

(8) Rich ground-end interface, Coach PPM input + output, RJ45 network interface, long-distance connection to the internal network, Type-C Android high speed USB interface, OTG interface can be connected to U disk and network card, etc., expanded TF card slot.

(9) An independent 2-dimensional gimbal joystick makes the gimbal flying with great facility, like a duck to water.

## 2、 Main purpose and scope of application

It is used to remotely operate helicopters, fixed wings, multi-rotors, vehicles, ships, etc. for video image transmission (optional camera), data transmission, and control drone flight.

## 3、 Specifications

### Remote Controller Specification

Model No.	H16/H16 Pro	Channels	16
Working voltage	4.2V	RF Power	20DB
Frequency	2.400-2.483GHZ	Frequency hopping	Newest FHSS
Update way	APP Update online	Weight	1034G
Size	272*183*94MM	Battery	20000MAH
Endurance	6-20 Hrs	Charging port	TYPE-C
Applications	Helicopter, fixed wing, multi-rotor, unmanned vehicle, unmanned boat, etc.		

### Receiver Specification

Model No.	R16	Channels	16
Working Voltage	7.2-72V	RF Power	20DB
Size	76*59*11MM	Weight	90G

### MIPI Night Camera Specification

Model No.	MIPI	Working current(light on)	140MA
Working voltage	14-72V	Working current (light off)	14MA
Size	102.1*42.6*36.5MM	Weight	55G

## 4、 The composition of the model and its significance

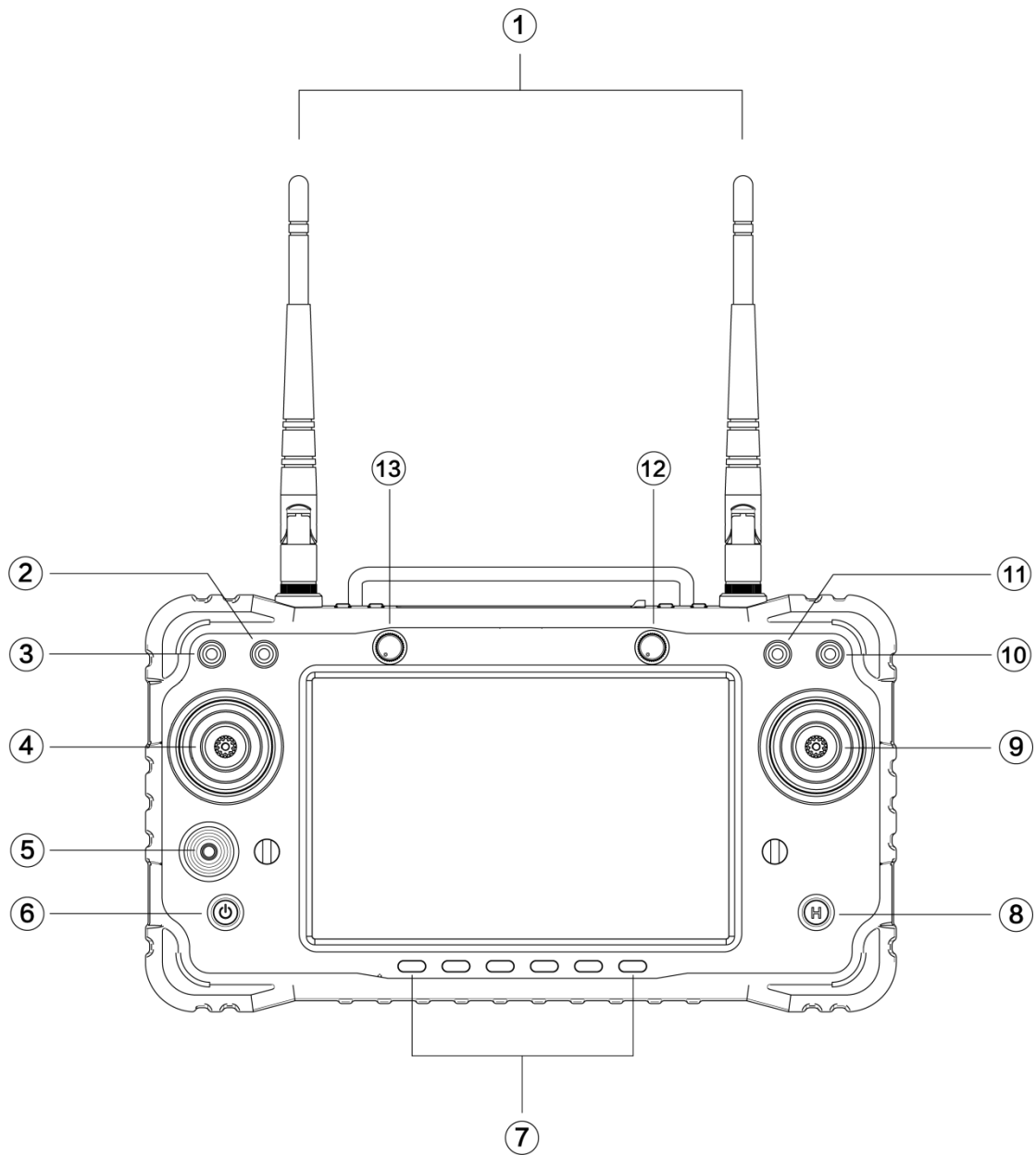

Number	Annotation	Number	Annotation
1	2.4G 3dB antenna	10	Toggle 3 positions switcherSW4
2	Toggle 3 positions switcher SW2	11	Toggle 3 positions switcherSW3
3	Toggle 3 positions switcherSW1	12	Knob AUX2
4	Left stick X1. Y1	13	KnobAUX1
5	Little stick X3. Y3		
6	Power switcher		
7	6 positions switcher		
8	Key button		
9	Right stick X2. Y2		

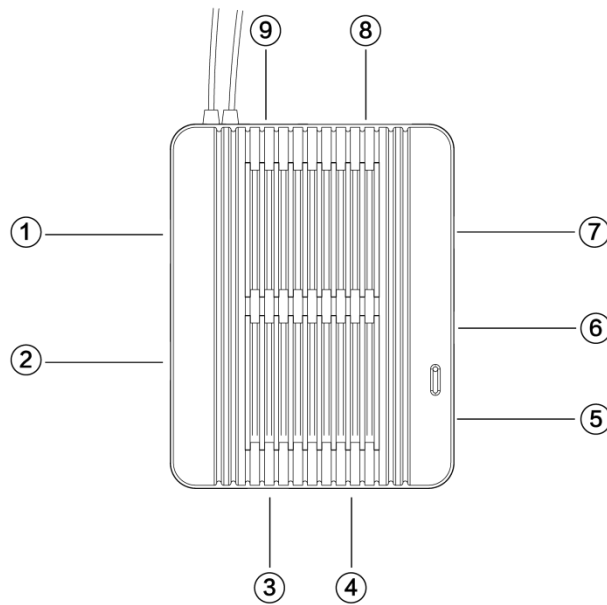
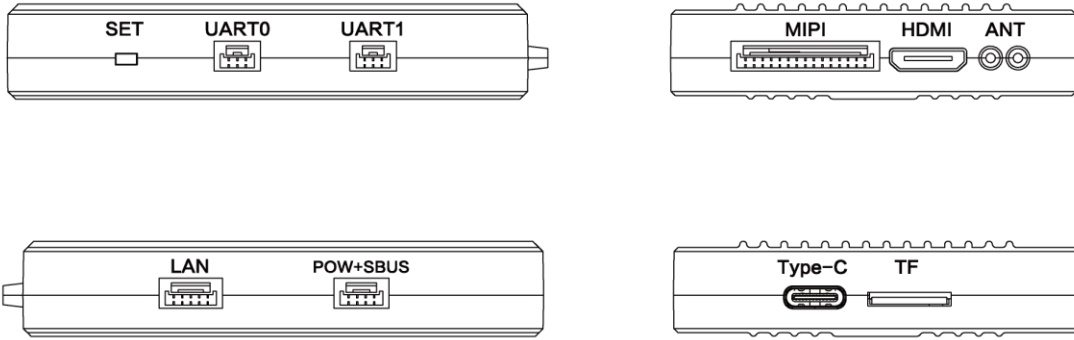

Number	Annotation	Number	Annotation
1	Network port	6	Uart 0
2	Power and Sbus input	7	Uart1
3	Type-C	8	MIPI 摄像头接口
4	TF slot	9	HDMI input
5	Button for binding		

## 5、Environment conditions

Pay attention

- A) Working temperature
- b) Storage temperature

- c) Relative humidity
- d) Atmospheric pressure
- e) Working environment should not contain explosive material or any corrosive or harmful gas may cause interference in the operation of the product.
- f) Always work under shelter to prevent rain, snow, wind, sand and dust contamination.

## 6、 Working conditions

### Power supply and attentions

H16 series uses a built in Li-ion battery. Charging port is compatible with common Type-C 9V-2A chargers (such as cell phone, digital cameras' USB charger)

In case of smoke, heat or unusual smell during charging, please stop charging immediately and return to our company for servicing as soon as possible.

Do not leave the product unattended while charging. Do not leave the product in a place where children can reach. Do not charge when room temperature over 60 ℃

## 7、 Safety

### Warning

Beginners should pay attention for the followings! Please read it carefully!

DO NOT fly under the influence of substances, or when tired!

DO NOT fly in strong wind and or rainy conditions!

DO NOT fly close to electric emission towers, communication stations and crowded area!

DO NOT fly nearby airports and other prohibited areas!

DO NOT fly around people or animals, or in any location where possible to damage property

Check equipment before every flight and check whether the transceiver system and the aircraft are normal or not.

Please use certified chargers to charge the batteries.

DO NOT put unnecessary force on antennas since its weakness.

## Part one

### Operation

#### 1、 Preparation and pre-checking before use

##### Pay attention

- ① Check battery level.
- ② Check position of the antenna to get the best performance
- ③ Make sure the firmware is the latest version
- ④ DO NOT operate under the influence of alcohol or drugs

#### 2、 Operation

##### Language setting

- ① Enter system setting, choose your language and input method

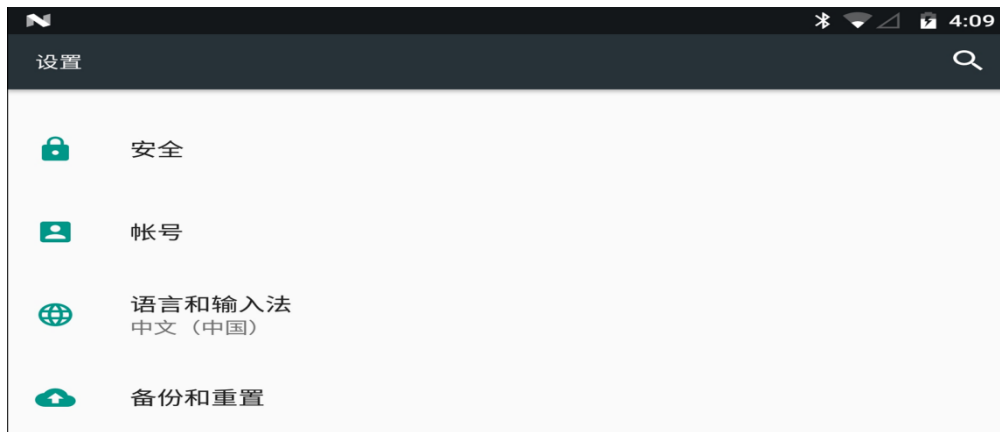

- ② Once entering language and input method choosing, you can add/cancel/choose the language you want

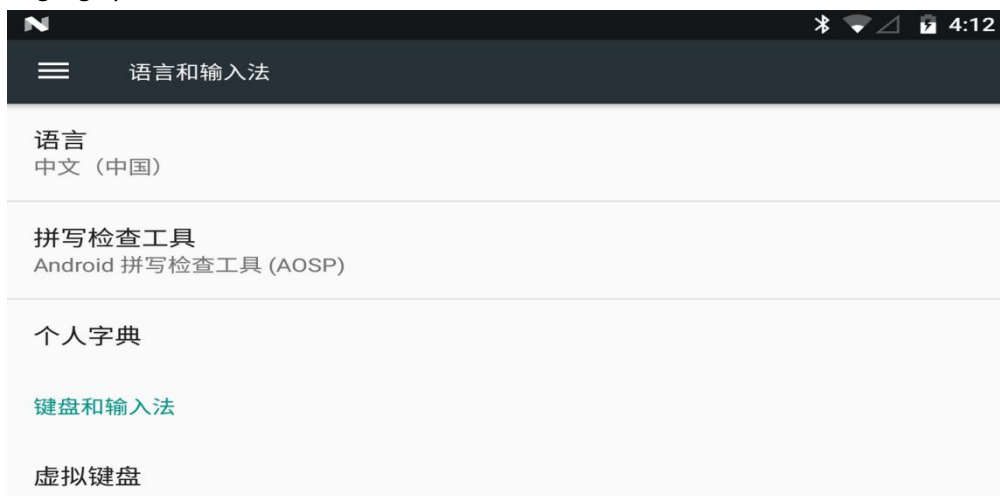

Part two

### Status bar



- ① Icon for connecting internet by network port or USB
- ② Icon for connecting well between the TX and RX (icon in picture shows no connecting with RX)
- ③ Icon for Power level
- ④ Icon for Time
- ⑤ Icon for return
- ⑥ Icon for back home
- ⑦ Icon for back ground management/screen splitter

### Part three

#### H16 Helper



- ① Switch the joystick operation mode of the remote control
- ② Check whether the value of each channel of the remote control is normal or not
- ③ You can view MIPI, HDMI, UART VIDEO and other RTSP videos (details are described below)
- ④ Binding the remote control with other receivers (the binding method is introduced below)
- ⑤ In the advanced parameters setting part, you can adjust the channel, upgrade the joystick firmware, and modify the receiver's serial port baud rate (password 999, it is only for professional debugging)

## Part four

### Binding operation

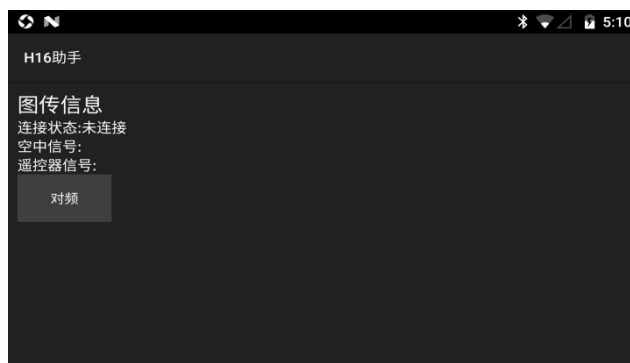

- ① After powering on the receiver, wait 3-5 seconds, then press and hold the receiver "SET", and release "SET" when the white light flashes
- ② Enter the H16 helper, click on the "binding", click on the "binding" (after the binding is successful, it will show "connected")

## Part five

### Video/Image connection and settings

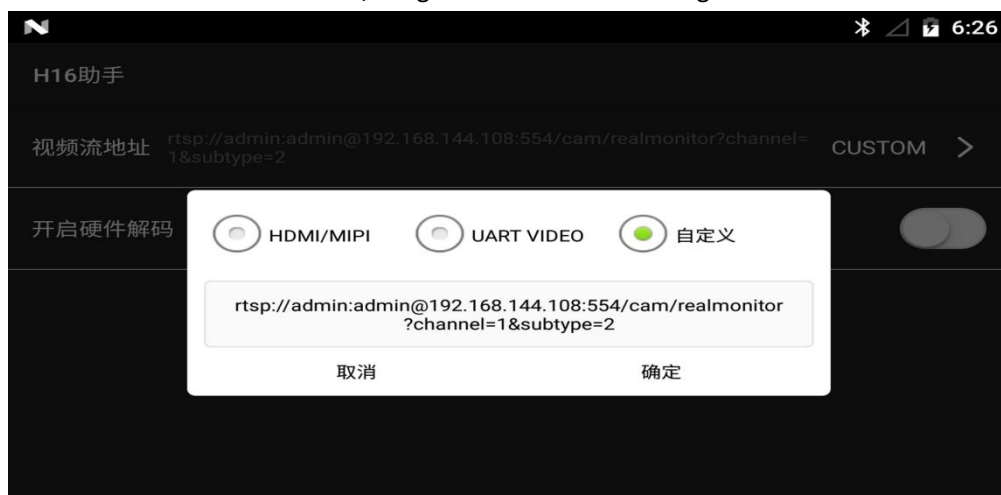

- ① The factory default setting is HDMI/MIPI mode, which is used to display the video/image transmitted through MIPI/HDMI from the receiver
- ② UART VIDEO mode, to display single-axis gimbal and MINI camera videos/images (need to connect other conversion board)
- ③ Custom mode, this mode displays the video/image transmitted through the network port of the receiver

## Part six



## Joystick calibration



Click on the rudder value in the H16 helper to view, and refer to the value for calibration

- ① When the remote control screen is completely off, center the knob. Long press the C and D keys in the six-position switcher, then slide the screen up and wake up the screen
- ② Release the C and D keys, and long press the D key. Calibration starts after the remote control sending out sounds
- ③ After reaching the maximum and minimum values of the left joystick, right joystick, small joystick and knob on the remote control, press the D key to exit the calibration mode

## Part seven

How to show video & data transmission and telemetry

Take QGC as the example for reference to connect video/image transmission

Showing video/image from network port

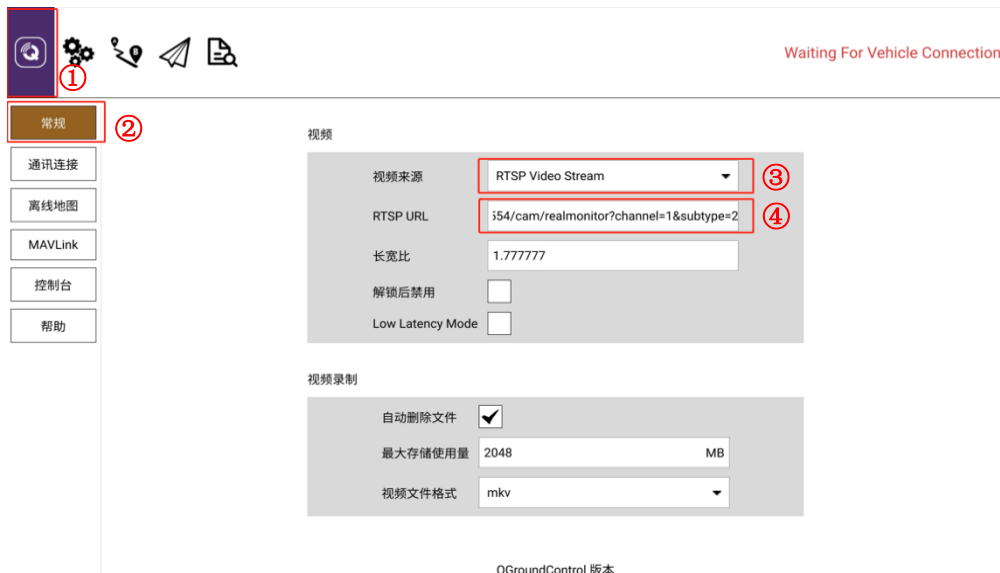

- ① Click the setting icon in QGC
- ② Click "Normal"
- ③ Change the video source to RTSP Video Stream
- ④ Enter RTSP address of the video/image to RTSP URL

Showing MIPI, HDMI video/image

① Enter "rtsp://192.168.0.10:8554/H264Video" to RTSP URL is OK

Take QGC as the example for reference to connect data/telemetry transmission



① Click the communication link

② Click "Add"

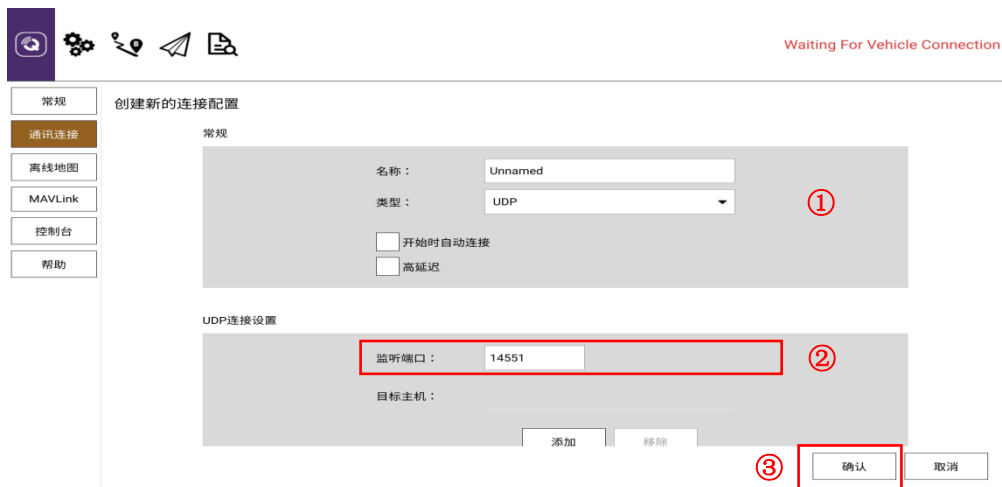

③ Change the mode into UDP, listening port to 14551

④ Click "OK" to save

## Part eight

How to connect the internet

The remote control can be connected to the Internet in three ways (1) connected to 5G wifi network (2) connected to the RJ45 port of the remote control (3) connected to the wireless internet card through the OTG port of the remote control for Internet access (currently only supports Huawei and CITIC wireless internet card)

## Part nine

How to share internet, video/image transmission and data/telemetry transmission

① Sharing network

When the remote control is connected to the Internet via the USB wireless internet card, the hotspot of the remote control can be turned on for network sharing

② Sharing data transmission

- (1) Turn on the hotspot of the remote controller
- (2) Connect the hotspot by PC
- (3) UDP Open Mission Planner, choose the connecting way into UDP

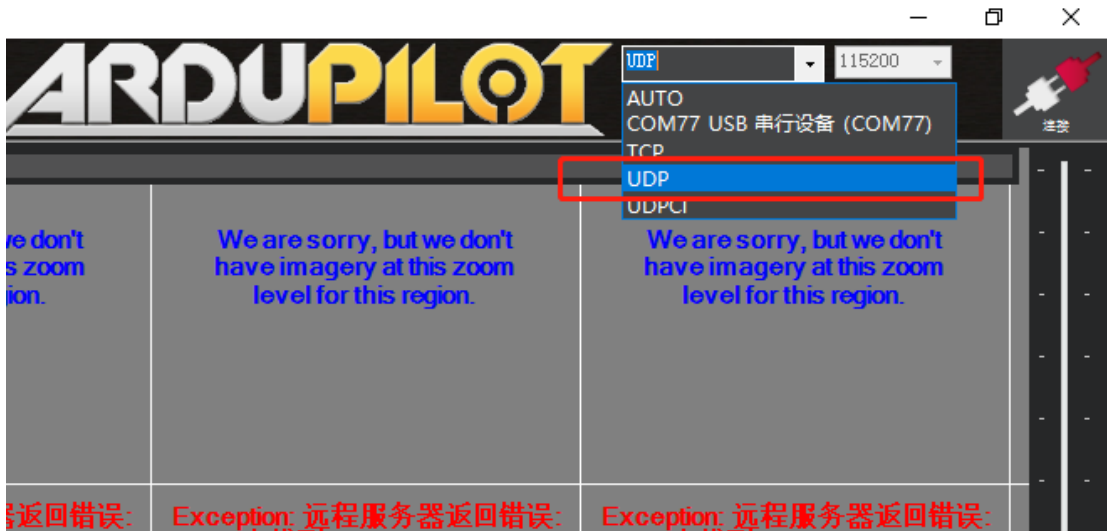

- (4) Click "connect" and select 14550 for the port number and click "OK".

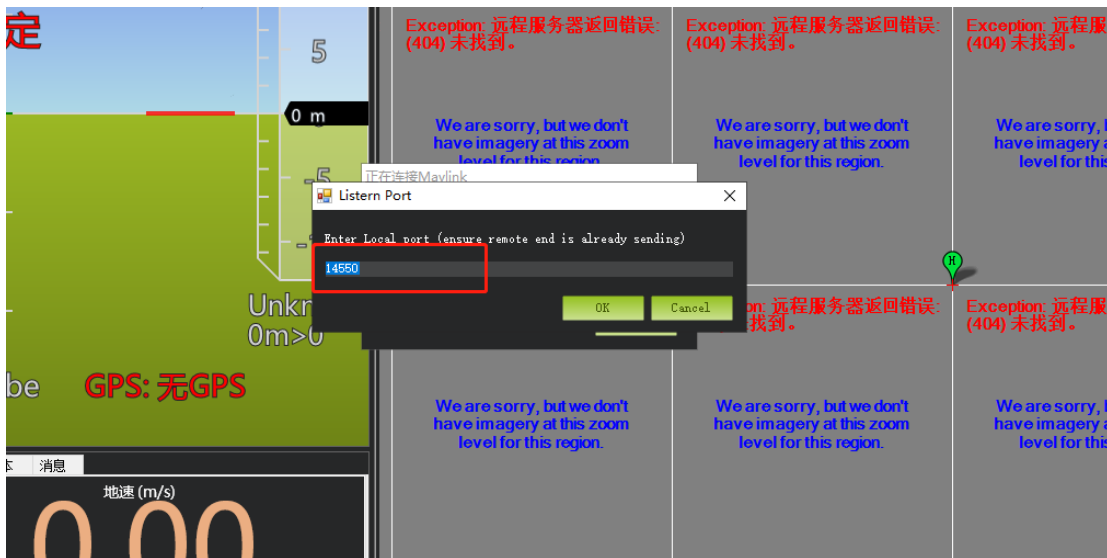

③ Sharing video/image transmission

- (1) Open the hotspot of the remote controller
- (2) Connect the hotspot by PC
- (3) Open "setting" in the PC, click on the "adapter", select Ethernet, select the IPV4 protocol, select a custom IP address, enter according to the method in the figure, and click "OK"

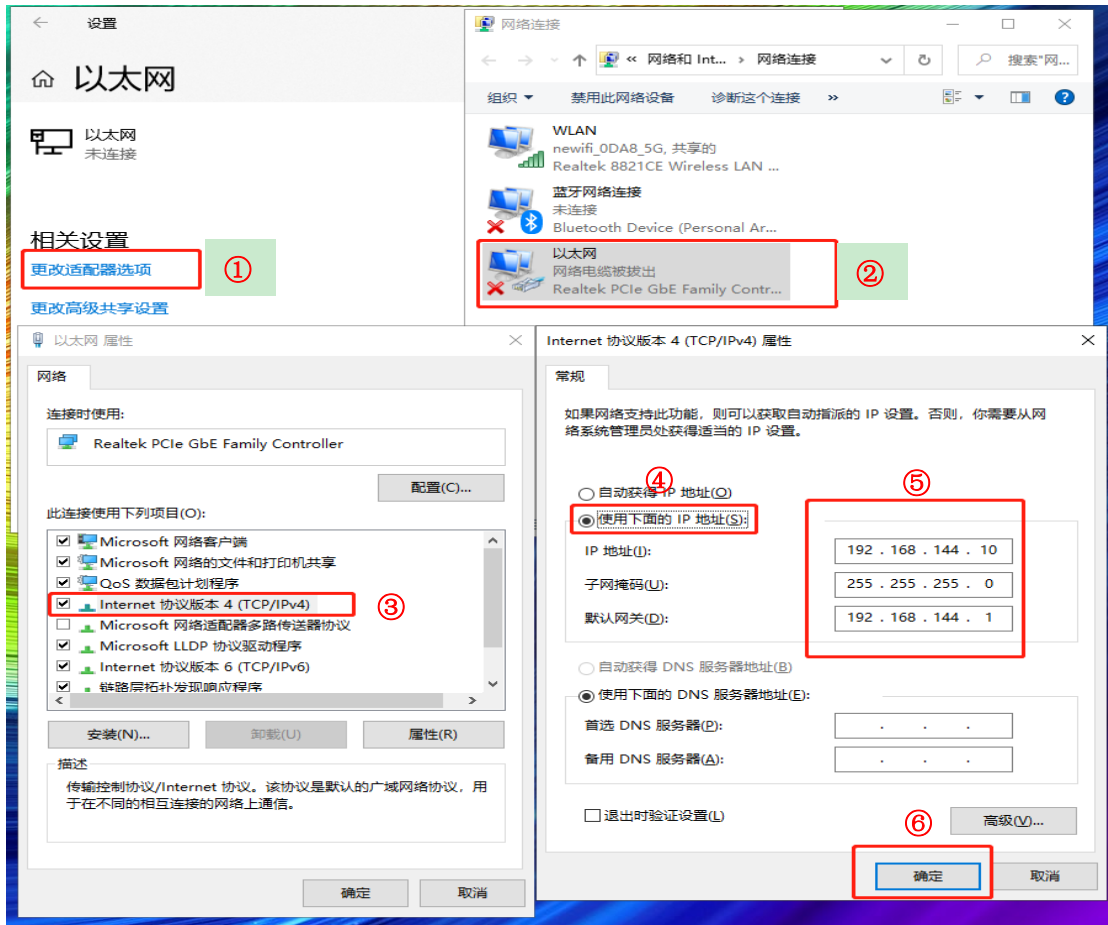

- (4) Download VLC executable to show video/image
- (5) Open VLC and choose network streaming
- (6) Enter "rtsp://192.168.43.1:8554/fpv\_stream" to URL and click "play"





## Q & A

1. Can the remote control install other apps?

The permissions of the remote control are all open, and there is no special software or restricted software installation and uninstallation.

2. How does the remote control enter the fast charge mode?

Only under using the original charger to enter the fast charge mode, and there is a text prompt on the lock screen interface

3. How to get the RTSP address when using MIPI or HDMI camera

Open the H16 helper, open the video to view, click on the settings (virtual button), click on the video stream address, click on custom to copy the link below that starts with RTSP. Then paste

4. Data transmission/telemetry cannot be connected

Check whether the ground station is connected with UDP type to connect to the TX and whether the listening port is 14551. Check whether the baud rate is normal. Check if RX and TX is connected reversely (connect RX to TX TX to RX correctly)

5. The video/image cannot be displayed after connecting to the webcam

The video/image transmitted through the network port has a dedicated RTSP address. Not compatible with MIPI/HDMI. This RTSP address needs to be consulted with the webcam manufacturer

6. The remote control's network port cannot be connected to the Internet

Please turn off WIFI when connecting 5G network card or network port

7. The remote control cannot connect to WIFI

The remote control can only connect to the 5G band WIFI, and the mobile phone can change the hotspot to the 5G band hotspot

8. Unable to share data/telemetry or video transmission

Please check if there is a hotspot connected to the remote control

### 3、 Maintenance, servicing

Storage for not using certain period

Put H16/H16 Pro in a dry and ventilated area. No direct sun light to prevent harm to the internal li-ion battery. If store it over three months, it is highly recommended to put room temperature between 22°C to 28 °C. DO NOT put it below 20 °C or higher than 45°C

### 4、 Transportation and storage

Warning

In order to prevent lost or getting hurt, please strictly follow the rules of operation:

Keep small parts or wire away from children can reach. DO NOT let children touch the small parts of H16/H16 Pro

Attention

- 1) DO NOT put H16/H16 Pro into water. If it does, please switch off the power and dry it at once!
- 2) DO NOT crash the H16/H16 Pro or break the battery is prohibited

## **FCC Statement**

This equipment has been tested and found to comply with the limits for a Class B digital device, pursuant to Part 15 of the FCC Rules. These limits are designed to provide reasonable protection against harmful interference in a residential installation. This equipment generates uses and can radiate radio frequency energy and, if not installed and used in accordance with the instructions, may cause harmful interference to radio communications. However, there is no guarantee that interference will not occur in a particular installation. If this equipment does cause harmful interference to radio or television reception, which can be determined by turning the equipment off and on, the user is encouraged to try to correct the interference by one or more of the following measures:

- Reorient or relocate the receiving antenna.
- Increase the separation between the equipment and receiver.
- Connect the equipment into an outlet on a circuit different from that to which the receiver is connected.
- Consult the dealer or an experienced radio/TV technician for help.

This device complies with part 15 of the FCC Rules. Operation is subject to the following two conditions:

(1) This device may not cause harmful interference, and (2) this device must accept any interference received, including interference that may cause undesired operation.

Changes or modifications not expressly approved by the party responsible for compliance could void the user's authority to operate the equipment.