



# FCC RADIO TEST REPORT

**FCC ID: 2ATGY-PWB1116**

**Product:** Power Bank  
**Trade Name:** ubiolabs  
**Model Name:** PWB1116  
PWB1116PG, PWB1116SG, PWB1116XX  
**Serial Model:** (where X should be any Arabian or English  
later or blank)  
**Report No.:** UNIA19080609FR-01

## Prepared for

Ubio Labs, Inc.

2821 Northup Way, Suite 250, Bellevue, WA 98004, USA

## Prepared by

Shenzhen United Testing Technology Co., Ltd.

2F, Annex Bldg, Jiahuangyuan Tech Park, #365 Baotian 1 Rd, Tiegang  
Community, Xixiang Str, Bao'an District, Shenzhen, China

### TEST RESULT CERTIFICATION

**Applicant's name**.....: Ubio Labs, Inc.  
**Address**.....: 2821 Northup Way, Suite 250, Bellevue, WA 98004, USA  
**Manufacture's Name**.....: Shenzhen PYS Industrial Co., LTD  
 Address.....: 1F, 3F, 5F, 6F, 7F, 8F, 10F, 11F, 12F, NO.9 LIANHUA INDUSTRIAL  
 LONGYUAN ROAD LONGHUA OFFICE LONGHUA NEW  
 DISTRICT SHENZHEN, GUANGDONG 518109 CHINA

**Product description**

Product name.....: Power Bank  
 Trade Mark.....: ubiolabs  
 Model and/or type reference : PWB1116, PWB1116PG, PWB1116SG, PWB1116XX (where X should be any Arabian or English later or blank)  
**Standards**.....: FCC Rules and Regulations Part 15 Subpart C Section 15.209  
 ANSI C63.10: 2013

This device described above has been tested by Shenzhen United Testing Technology Co., Ltd., and the test results show that the equipment under test (EUT) is in compliance with the FCC requirements. And it is applicable only to the tested sample identified in the report.

This report shall not be reproduced except in full, without the written approval of UNI, this document may be altered or revised by Shenzhen United Testing Technology Co., Ltd., personnel only, and shall be noted in the revision of the document.

**Date of Test**.....:   
 Date (s) of performance of tests.....: Aug.06, 2019 ~Aug.12, 2019  
 Date of Issue.....: Aug.12, 2019  
 Test Result.....: Pass

Prepared by:

*Kahn Yang*

Kahn yang/Editor

Reviewer:

*Sherwin Qian*

Sherwin Qian/Supervisor

Approved & Authorized Signer:

*Liuze*

Liuze/Manager

Table of Contents

Page

1 TEST SUMMARY.....	4
2 GENERAL INFORMATION.....	5
2.1 GENERAL DESCRIPTION OF EUT.....	5
2.2 Carrier Frequency of Channels.....	6
2.3 Operation of EUT during testing.....	6
2.4 DESCRIPTION OF TEST SETUP.....	6
2.5 MEASUREMENT INSTRUMENTS LIST.....	7
3 CONDUCTED EMISSION TEST.....	8
3.1 Conducted Power Line Emission Limit.....	8
3.2 Test Setup.....	8
3.3 Test Procedure.....	8
3.4 Test Result.....	8
4 RADIATED EMISSION TEST.....	11
4.1 Block Diagram of Test Setup.....	11
4.2 Rules and specifications.....	12
4.3 Test Procedure.....	13
4.4 Test Result.....	13
5 ANTENNA REQUIREMENT.....	16
6 PHOTOGRAPH OF TEST.....	17
6.1 Radiated Emission.....	17
6.2 Conducted Emission.....	18

## 1 TEST SUMMARY

### TEST PROCEDURES AND RESULTS

DESCRIPTION OF TEST	STANGARD	RESULT
CONDUCTED EMISSION TEST	FCC Part 15.207	COMPLIANT
RADIA TED EMISSION TEST	FCC Part 15.209	COMPLIANT
ANTENNA REQUIREMENT	FCC Part 15.203	COMPLIANT

### TEST FACILITY

Test Firm : Shenzhen United Testing Technology Co., Ltd.  
 Address :2F, Annex Bldg, Jiahuangyuan Tech Park, #365 Baotian 1 Rd,Tiegang Community, Xixiang Str, Bao'an District, Shenzhen, China

The testing quality ability of our laboratory meet with "Quality Law of People's Republic of China" Clause 19.The testing quality system of our laboratory meets with ISO/IEC-17025 requirements, which is approved by CNAS. This approval result is accepted by MRA of APLAC.

Our test facility is recognized, certified, or accredited by the following organizations:

CNAS-LAB Code: L6494

The EMC Laboratory has been assessed and in compliance with CNAS-CL01 accreditation criteria for testing Laboratories (identical to ISO/IEC 17025:2017 General Requirements) for the Competence of testing Laboratories.

Designation Number: CN1227

Test Firm Registration Number: 674885

The EMC Laboratory has been registered and fully described in a report filed with the (FCC) Federal Communications commission. The acceptance letter from the FCC is maintained in our files.

### MEASUREMENT UNCERTAINTY

#### Measurement Uncertainty

Conducted Emission Expanded Uncertainty	= 2.23dB, k=2
Radiated emission expanded uncertainty(9kHz-30MHz)	= 3.08dB, k=2
Radiated emission expanded uncertainty(30MHz-1000MHz)	= 4.42dB, k=2
Radiated emission expanded uncertainty(Above 1GHz)	= 4.06dB, k=2

## 2 GENERAL INFORMATION

### 2.1 GENERAL DESCRIPTION OF EUT

Equipment	Power Bank
Trade Mark	ubiolabs
Model Name	PWB1116
Serial No.	PWB1116PG, PWB1116SG, PWB1116XX (where X should be any Arabian or English later or blank)
Model Difference	All model's the function, software and electric circuit are the same, only with a product color and model named different. Test sample model: PWB1116.
FCC ID	2ATGY-PWB1116
Antenna Type	Coil Antenna
Antenna Gain	0dBi
Operation frequency	125KHz
Number of Channels	1CH
Modulation Type	MSK
Battery	3.8V 4000mAh
PowerSource	DC 5V from adapter



## 2.2 Carrier Frequency of Channels

Operation Frequency each of channel	
Channel	Frequency
01	125KHz

## 2.3 Operation of EUT during testing

Operating Mode

The mode is used: Transmitting mode

## 2.4 DESCRIPTION OF TEST SETUP

Operation of EUT during testing:



Setup: Transmission mode

Table for auxiliary equipment:

Equipment Description	Manufacturer	Model	Calibration Due Date
Adapter	XinShenHai	P12USB020200	N/A
Mobile phone	Huawei	V6	N/A



## 2.5 MEASUREMENT INSTRUMENTS LIST

Item	Equipment	Manufacturer	Model No.	Serial No.	Calibrated until
CONDUCTED EMISSIONS TEST					
1	AMN	Schwarzbeck	NNLK8121	8121370	2019.9.9
2	AMN	ETS	3810/2	00020199	2019.9.9
3	EMI TEST RECEIVER	Rohde&Schwarz	ESCI	101210	2019.9.9
4	AAN	TESEQ	T8-Cat6	38888	2019.9.9
RADIATED EMISSION TEST					
1	Horn Antenna	Sunol	DRH-118	A101415	2019.9.29
2	BicoNILog Antenna	Sunol	JB1 Antenna	A090215	2019.9.29
3	PREAMP	HP	8449B	3008A00160	2019.9.9
4	PREAMP	HP	8447D	2944A07999	2019.9.9
5	EMI TEST RECEIVER	Rohde&Schwarz	ESR3	101891	2019.9.9
6	VECTOR Signal Generator	Rohde&Schwarz	SMU200A	101521	2019.9.28
7	Signal Generator	Agilent	E4421B	MY4335105	2019.9.28
8	MXA Signal Analyzer	Agilent	N9020A	MY50510140	2019.9.28
9	MXA Signal Analyzer	Agilent	N9020A	MY51110104	2019.9.9
10	ANT Tower&Turn table Controller	Champro	EM 1000	60764	2019.9.28
11	Anechoic Chamber	Taihe Maorui	9m*6m*6m	966A0001	2019.9.9
12	Shielding Room	Taihe Maorui	6.4m*4m*3m	643A0001	2019.9.9
13	RF Power sensor	DARE	RPR3006W	15I00041SNO88	2020.3.14
14	RF Power sensor	DARE	RPR3006W	15I00041SNO89	2020.3.14
15	RF power divider	Anritsu	K241B	992289	2019.9.28
16	Wideband radio communication tester	Rohde&Schwarz	CMW500	154987	2019.9.28
17	Biconical antenna	Schwarzbeck	VHA 9103	91032360	2019.9.8
18	Biconical antenna	Schwarzbeck	VHA 9103	91032361	2019.9.8
19	Broadband Hybrid Antennas	Schwarzbeck	VULB9163	VULB9163#958	2019.9.8
20	Horn Antenna	Schwarzbeck	BBHA9120D	9120D-1680	2020.1.12
21	Active Receive Loop Antenna	Schwarzbeck	FMZB 1919B	00023	2019.9.8
22	Horn Antenna	Schwarzbeck	BBHA 9170	BBHA9170651	2020.03.14
23	Microwave Broadband Preamplifier	Schwarzbeck	BBV 9721	100472	2019.9.8
24	Active Loop Antenna	Com-Power	AL-130R	10160009	2020.05.10
25	Power Meter	KEYSIGHT	N1911A	MY50520168	2020.05.10
26	Frequency Meter	VICTOR	VC2000	997406086	2020.05.10
27	DC Power Source	HYELEC	HY5020E	055161818	2020.05.10

### 3 CONDUCTED EMISSION TEST

#### 3.1 Conducted Power Line Emission Limit

For unintentional device, according to § 15.107(a) Line Conducted Emission Limits is as following

Frequency (MHz)	Maximum RF Line Voltage(dB $\mu$ V)			
	CLASS A		CLASS B	
	Q.P.	Ave.	Q.P.	Ave.
0.15~0.50	79	66	66~56*	56~46*
0.50~5.00	73	60	56	46
5.00~30.0	73	60	60	50

\* Decreasing linearly with the logarithm of the frequency

For intentional device, according to §15.207(a) Line Conducted Emission Limit is same as above table.

#### 3.2 Test Setup

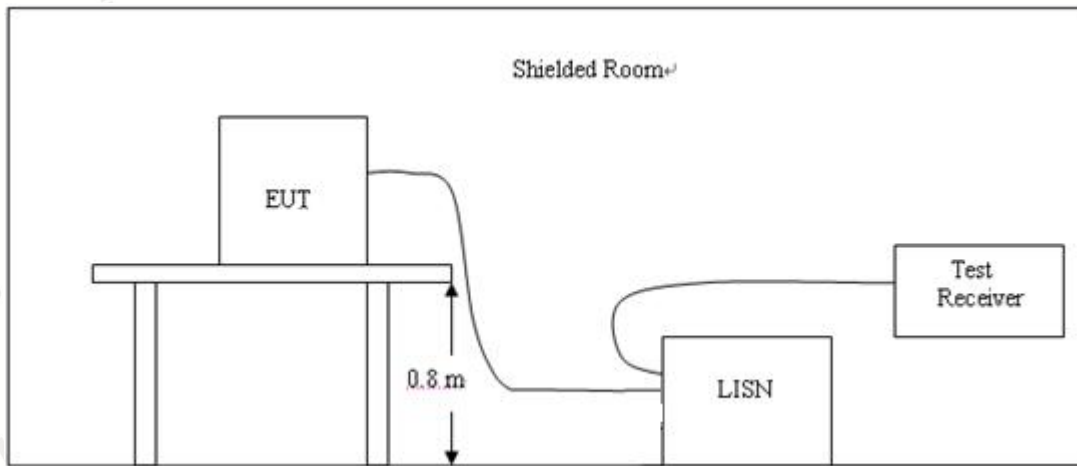

#### 3.3 Test Procedure

- 1, The equipment was set up as per the test configuration to simulate typical actual usage per the user's manual. A wooden table with a height of 0.8 meters is used and is placed on the ground plane as per ANSI C63.10.
- 2, Support equipment, if needed, was placed as per ANSI C63.10.
- 3, All I/O cables were positioned to simulate typical actual usage as per ANSI C63.10.
- 4, If a EUT received DC power from the USB Port of Notebook PC, the PC's adapter received AC120V/60Hz power through a Line Impedance Stabilization Network (LISN) which supplied power source and was grounded to the ground plane.
- 5, All support equipments received AC power from a second LISN, if any.
- 6, The EUT test program was started. Emissions were measured on each current carrying line of the EUT using a spectrum Analyzer / Receiver connected to the LISN powering the EUT. The LISN has two monitoring points: Line 1 (Hot Side) and Line 2 (Neutral Side). Two scans were taken: one with Line 1 connected to Analyzer / Receiver and Line 2 connected to a 50 ohm load; the second scan had Line 1 connected to a 50 ohm load and Line 2 connected to the Analyzer / Receiver.
- 7, Analyzer/Receiver scanned from 150 KHz to 30MHz for emissions in each of the test modes.

#### 3.4 Test Result

##### PSSS

Remark: EUT was tested at AC 120V and 240V, only the worst result of AC 120V was reported.





Temperature:	24°C	Relative Humidity:	45%
Test Date:	Aug. 10, 2019	Pressure:	1010hPa
Test Voltage:	AC 120V, 60Hz	Phase:	Line
Test Mode:	Transmitting mode		

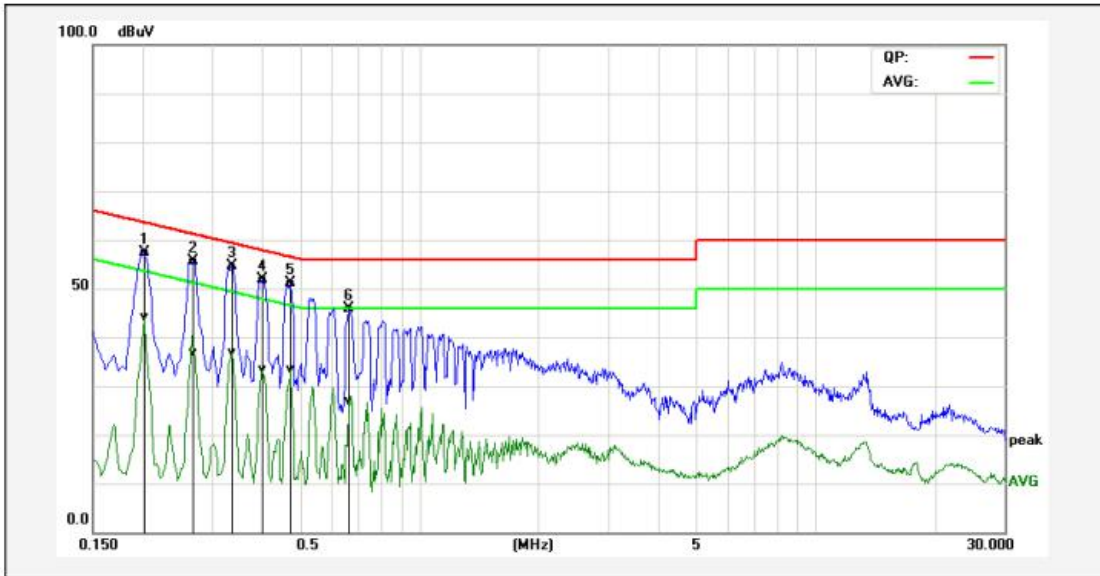

No.	Frequency (MHz)	QuasiPeak reading (dBuV)	Average reading (dBuV)	Correction factor (dB)	QuasiPeak result (dBuV)	Average result (dBuV)	QuasiPeak limit (dBuV)	Average limit (dBuV)	QuasiPeak margin (dB)	Average margin (dB)	Remark
1P	0.2020	47.56	34.48	9.73	57.29	44.21	63.52	53.53	-6.23	-9.32	Pass
2P	0.2700	45.84	27.14	9.78	55.62	36.92	61.12	51.12	-5.50	-14.20	Pass
3*	0.3379	44.68	26.94	9.82	54.50	36.76	59.25	49.25	-4.75	-12.49	Pass
4P	0.4020	41.95	23.65	9.82	51.77	33.47	57.81	47.81	-6.04	-14.34	Pass
5P	0.4740	41.31	23.49	9.80	51.11	33.29	56.44	46.44	-5.33	-13.15	Pass
6P	0.6620	36.00	17.03	9.81	45.81	26.84	56.00	46.00	-10.19	-19.16	Pass

Remark: Factor = Insertion Loss + Cable Loss, Result = Reading + Factor, Margin = Result – Limit.

Temperature:	24°C	Relative Humidity:	45%
Test Date:	Aug. 10, 2019	Pressure:	1010hPa
Test Voltage:	AC 120V, 60Hz	Phase:	Neutral
Test Mode:	Transmitting mode		

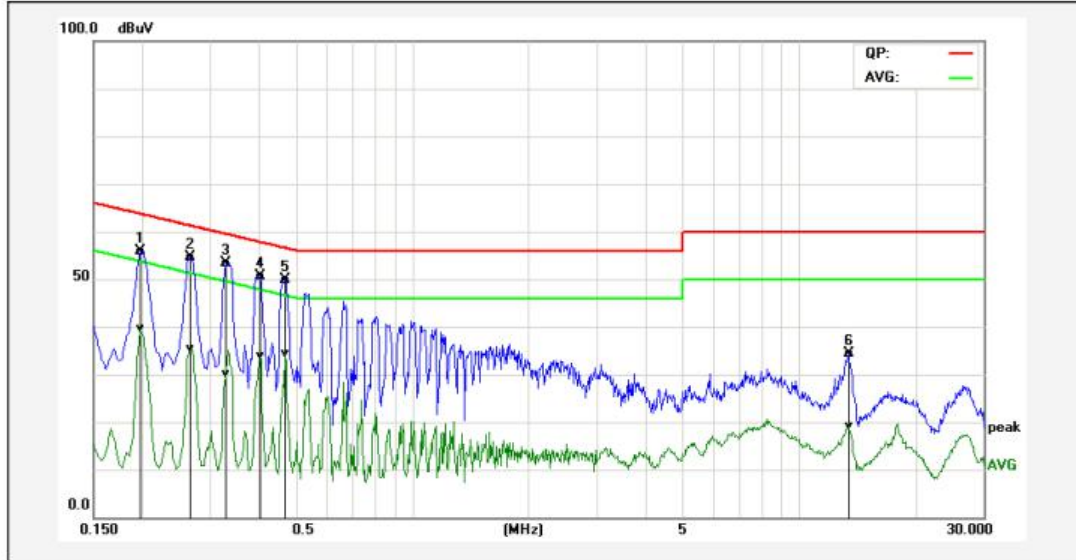

No.	Frequency (MHz)	QuasiPeak reading (dBuV)	Average reading (dBuV)	Correction factor (dB)	QuasiPeak result (dBuV)	Average result (dBuV)	QuasiPeak limit (dBuV)	Average limit (dBuV)	QuasiPeak margin (dB)	Average margin (dB)	Remark
1P	0.1980	46.25	29.84	9.73	55.98	39.57	63.69	53.69	-7.71	-14.12	Pass
2P	0.2660	44.91	25.54	9.78	54.69	35.32	61.24	51.24	-6.55	-15.92	Pass
3*	0.3300	43.64	20.43	9.81	53.45	30.24	59.45	49.45	-6.00	-19.21	Pass
4P	0.4060	40.70	23.95	9.82	50.52	33.77	57.73	47.73	-7.21	-13.96	Pass
5P	0.4700	40.10	24.49	9.80	49.90	34.29	56.51	46.51	-6.61	-12.22	Pass
6P	13.4100	34.01	18.96	0.25	34.26	19.21	60.00	50.00	-25.74	-30.79	Pass

Remark: Factor = Insertion Loss + Cable Loss, Result = Reading + Factor, Margin = Result – Limit.

## 4 RADIATED EMISSION TEST

### 4.1 Block Diagram of Test Setup

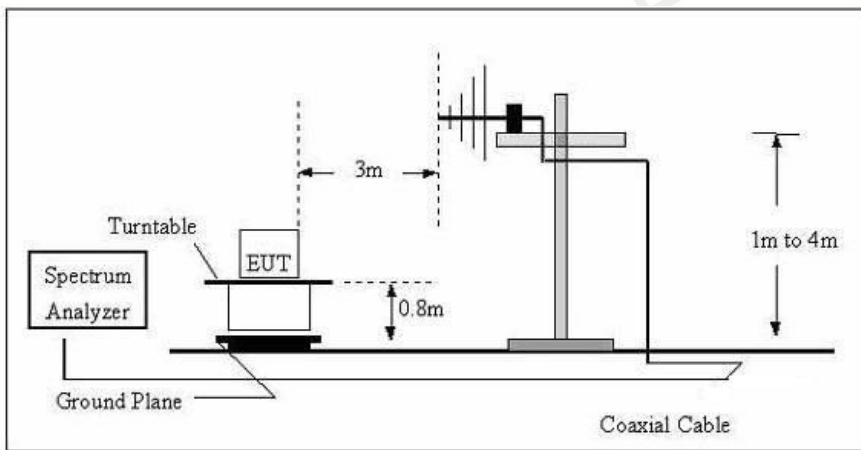
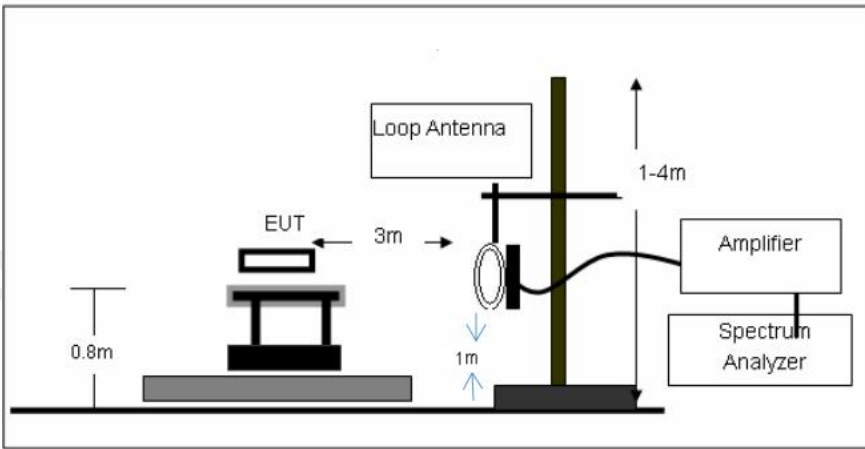



4.2 Rules and specifications

CFR 47 Part 15, section 15.205

Only spurious emissions are permitted in any of the frequency bands listed the tables in these sections.

MHz	MHz	MHz	GHz
0.090-0.110	16.42-16.423	399.9-410	4.5-5.15
1\ 0.495-0.505	16.69475-16.69525	608-614	5.35-5.46
2.1735-2.1905	16.80425-16.80475	960-1240	7.25-7.75
4.125-4.128	25.5-25.67	1300-1427	8.025-8.5
4.17725-4.17775	37.5-38.25	1435-1626.5	9.0-9.2
4.20725-4.20775	73-74.6	1645.5-1646.5	9.3-9.5
6.215-6.218	74.8-75.2	1660-1710	10.6-12.7
6.26775-6.26825	108-121.94	1718.8-1722.2	13.25-13.4
6.31175-6.31225	123-138	2200-2300	14.47-14.5
8.291-8.294	149.9-150.05	2310-2390	15.35-16.2
8.362-8.366	156.52475-156.52525	2483.5-2500	17.7-21.4
8.37625-8.38675	156.7-156.9	2690-2900	22.01-23.12
8.41425-8.41475	162.0125-167.17	3260-3267	23.6-24.0
12.29-12.293	167.72-173.2	3332-3339	31.2-31.8
12.51975-12.52025	240-285	3345.8-3358	36.43-36.5
12.57675-12.57725	322-335.4	3600-4400	(12)
13.36-13.41			

CFR 47 Part 15, section 15.209

The emissions from an intentional radiator shall not exceed the limits in the tables in these sections using an average detector

Frequency (MHz)	Field strength (microvolts/meter)	Measurement distance (meters)
0.009-0.490	2400/F(kHz)	300
0.490-1.705	24000/F(kHz)	30
1.705-30.0	30	30
30-88	100**	3
88-216	150**	3
216-960	200**	3
Above 960	500	3

Limit calculation and transfer to 3m distance as showed in the following table:

Frequency (MHz)	Limit (dBuV/m)	Distance (m)
0.009-0.490	$20\log(2400/F(KHz))+40\log(300/3)$	3
0.490-1.705	$20\log(24000/F(KHz))+40\log(30/3)$	3
1.705-30.0	69.5	3
30-88	40.0	3
88-216	43.5	3
216-960	46.0	3
Above 960	54.0	3

CFR 47 Part 15, section 15.35

When average radiated emission measurements are specified, the limit on the peak level of the radio Frequency emission is 20dB above the maximum permitted average emission limit.

Transmitter Spurious Emissions 9KHz-30MHz			
	9-150KHz	150-490KHz	490KHz-30MHz
Resolution Bandwidth	200Hz	9KHz	9KHz
Video Bandwidth	2KHz	100KHz	100KHz
Detector	Peak	Peak	Peak
Trace Mode	Max Hold	Max Hold	Max Hold
Sweep Time	Auto	Auto	Auto



### 4.3 Test Procedure

Measurement distance is 3m.

For the measurement range up to 30MHz in the following plots the field strength result from 3m Distance measurement are extrapolated to 300m and 30m distance respectively, by 40dB/decade, According to part 15.31(f)(2), per antenna factor scaling.

Measurements below 1000MHz are performed with a peak detector and compared to average limits, Measurements with an average detector are not required.

Note:

For battery operated equipment, the equipment tests shall be performed using a new battery.

### 4.4 Test Result

PASS

For 9KHz-30MHz Test Results:

Freq. (MHz)	Detector Mode (PK/QP)	Reading (dBuV)	Factor (dB)	Actual FS (dBuV/m)	Limits 3m (dBuV/m)	Margin (dBuV/m)
0.125	Peak	67.68	15.48	83.16	105.67	-22.51
0.610	Peak	28.14	16.08	44.24	71.90	-27.66
1.120	Peak	29.26	16.22	45.48	66.62	-21.14
1.876	Peak	28.15	15.15	43.30	69.50	-26.20
3.869	Peak	31.59	15.65	47.24	69.50	-22.26



For 30MHz-1GHz Test Results:

Temperature:	26°C	Relative Humidity:	44%
Test Date:	Aug. 10, 2019	Pressure:	1010hPa
Test Voltage:	AC 120V, 60Hz	Polarization:	Horizontal
Test Mode:	Transmitting mode		

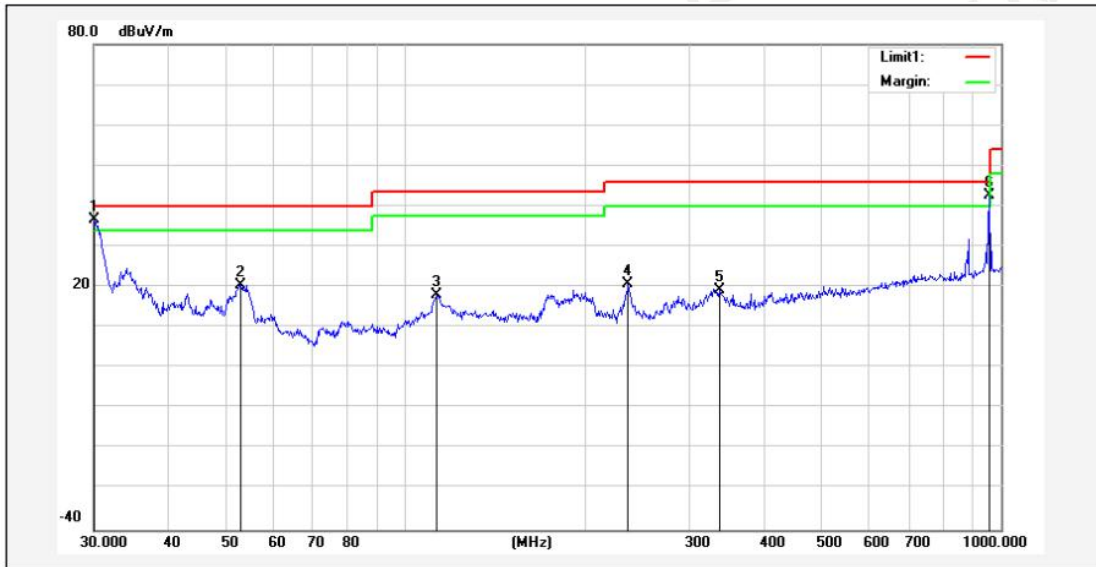

No.	Frequency (MHz)	Reading (dBuV)	Correction factor (dB/m)	Result (dBuV/m)	Limit (dBuV/m)	Margin (dB)	Degree (deg.)	Height (cm)	Remark
1*	30.1054	44.01	-7.23	36.78	40.00	-3.22	120	100	peak
2	52.9453	42.72	-22.14	20.58	40.00	-19.42	60	150	peak
3	112.9196	35.07	-16.96	18.11	43.50	-25.39	75	100	peak
4	236.6447	37.64	-16.96	20.68	46.00	-25.32	300	200	peak
5	337.2155	33.71	-14.34	19.37	46.00	-26.63	210	100	peak
6!	955.4381	48.32	-5.77	42.55	46.00	-3.45	100	150	peak

Remark: Absolute Level= Reading Level+ Factor, Margin= Absolute Level – Limit  
 Factor=Ant. Factor + Cable Loss – Pre-amplifier

Temperature:	26°C	Relative Humidity:	44%
Test Date:	Aug. 10, 2019	Pressure:	1010hPa
Test Voltage:	AC 120V, 60Hz	Polarization:	Vertical
Test Mode:	Transmitting mode		

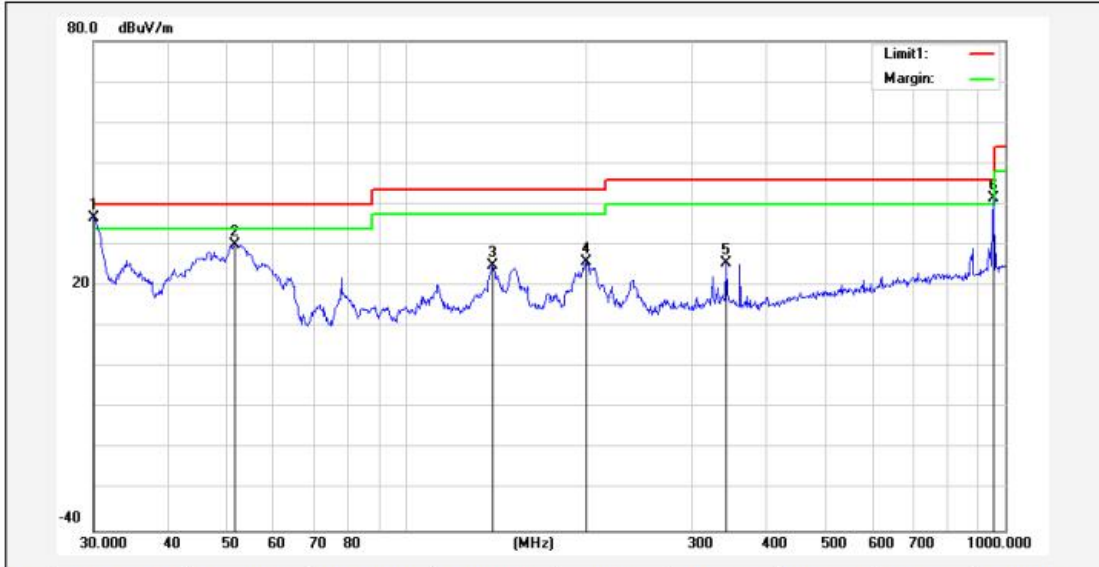

No.	Frequency (MHz)	Reading (dBuV)	Correction factor(dB/m)	Result (dBuV/m)	Limit (dBuV/m)	Margin (dB)	Degree (deg.)	Height (cm)	Remark
1*	30.1054	43.36	-6.75	36.61	40.00	-3.39	240	200	peak
2	51.6616	51.54	-21.37	30.17	40.00	-9.83	60	100	peak
3	139.3613	39.16	-14.21	24.95	43.50	-18.55	105	100	peak
4	199.9856	39.74	-13.89	25.85	43.50	-17.65	90	200	peak
5	341.9787	37.91	-12.38	25.53	46.00	-20.47	280	100	peak
6!	955.4381	43.84	-2.35	41.49	46.00	-4.51	170	150	peak

Remark: Absolute Level= Reading Level+ Factor, Margin= Absolute Level – Limit  
 Factor=Ant. Factor + Cable Loss – Pre-amplifier

Remark:

- (1) Measuring frequencies from 9 KHz to the 1 GHz, Radiated emission test from 9KHz to 30MHz was verified, and no any emission was found except system noise floor.
- (2) \* denotes emission frequency which appearing within the Restricted Bands specified in provision of 15.205, then the general radiated emission limits in 15.209 apply.
- (3) The IF bandwidth of EMI Test Receiver between 30MHz to 1GHz was 120KHz, 1 MHz for measuring above 1 GHz, below 30MHz was 10KHz.

## 5 ANTENNA REQUIREMENT

### Standard Applicable:

For intentional device, according to FCC 47 CFR Section 15.203, an intentional radiator shall be designed to ensure that no antenna other than that furnished by the responsible party shall be used with the device.

### Antenna Connected Construction

The antenna used in this product is a Coil Antenna, The directional gains of antenna used for transmitting is 0dBi.

### ANTENNA:

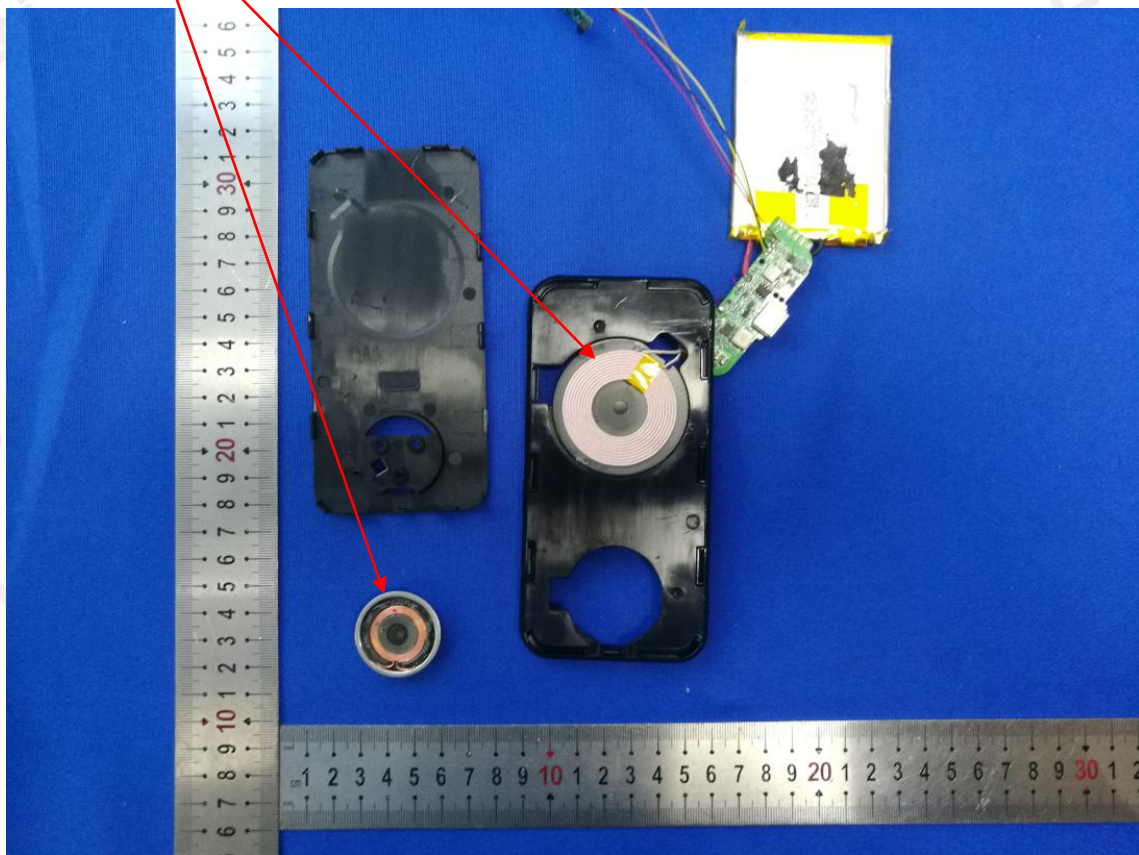



## 6 PHOTOGRAPH OF TEST

### 6.1 Radiated Emission

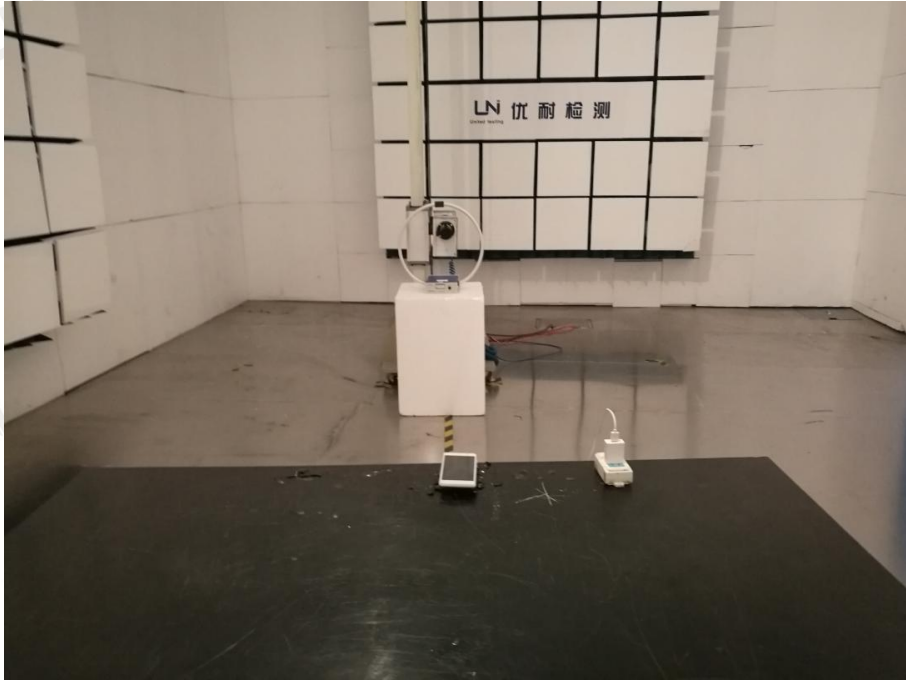

6.2 Conducted Emission



\*\*\*End of Report\*\*\*