



FCC PART 15C
TEST REPORT

For

Ubio Labs, Inc.

2821 Northup Way, Suite 250, Bellevue, WA 98004, USA

FCC ID: 2ATGY-PWB1085

Report Type: Original Report	Product Type: Power Bank
Report Number:	RGMA191225001-00B
Report Date:	2020-01-13
Reviewed By:	Simon Wang RF Engineer <i>Simon wang</i>
Prepared By:	Bay Area Compliance Laboratories Corp. (Shenzhen) 6/F., West Wing, Third Phase of Wanli Industrial Building, Shihua Road, Futian Free Trade Zone, Shenzhen, Guangdong, China Tel: +86-755-33320018 Fax: +86-755-33320008 www.baclcorp.com.cn

Note: This report must not be used by the customer to claim product certification, approval, or endorsement by A2LA* or any agency of the Federal Government. This report may contain data that are not covered by the A2LA accreditation and are marked with an asterisk “★”.

BACL is not responsible for the authenticity of any test data provided by the applicant. Data included from the applicant that may affect test results are marked with an asterisk “*”. Customer model name, addresses, names, trademarks etc. are not considered data.

This report cannot be reproduced except in full, without prior written approval of the Company. Unless otherwise stated the results shown in this test report refer only to the sample(s) tested.

TABLE OF CONTENTS

GENERAL INFORMATION.....3

 PRODUCT DESCRIPTION FOR EQUIPMENT UNDER TEST (EUT)3

 OBJECTIVE3

 RELATED SUBMITTAL(S)/GRANT(S).....3

 TEST METHODOLOGY3

 MEASUREMENT UNCERTAINTY.....4

 TEST FACILITY4

SYSTEM TEST CONFIGURATION.....5

 JUSTIFICATION5

 EUT EXERCISE SOFTWARE5

 SUPPORT EQUIPMENT LIST AND DETAILS5

 EXTERNAL I/O CABLE.....5

 BLOCK DIAGRAM OF TEST SETUP6

SUMMARY OF TEST RESULTS7

TEST EQUIPMENT LIST8

FCC §1.1310, §2.1091- MAXIMUM PERMISSIBLE EXPOSURE (MPE).....9

 APPLICABLE STANDARD9

 BLOCK DIAGRAM OF TEST SETUP10

 TEST DATA10

FCC§15.203 – ANTENNA REQUIREMENT12

 APPLICABLE STANDARD12

 ANTENNA CONNECTED CONSTRUCTION12

FCC §15.207 – AC LINE CONDUCTED EMISSION13

 APPLICABLE STANDARD13

 EUT SETUP.....13

 EMI TEST RECEIVER SETUP.....13

 TEST PROCEDURE13

 CORRECTED FACTOR & MARGIN CALCULATION14

 TEST RESULTS SUMMARY14

 TEST DATA14

FCC §15.205 & §15.209 - RADIATED EMISSIONS TEST17

 APPLICABLE STANDARD17

 EUT SETUP17

 EMI TEST RECEIVER SETUP.....18

 CORRECTED AMPLITUDE & MARGIN CALCULATION18

 TEST RESULTS SUMMARY18

 TEST DATA18

GENERAL INFORMATION

Product Description for Equipment Under Test (EUT)

Product	Power Bank
Tested Model	PWB1085
Multiple Model	PWB1085SG, PWB1085XX (XX would be any Arabian number or English letter or blank)
Frequency Range	110 kHz-205kHz
Antenna Specification	Coil
Voltage Range	Powered: DC 3.7V from internal rechargeable battery Recharged: DC 5.0V from charging port
Date of Test	2019/01/03~2020/01/10
Sample serial number	191225001 (Assigned by BACL, Shenzhen)
Received date	2019/12/25
Sample/EUT Status	Good Condition

Notes: This series products model: PWB1085SG, PWB1085XX (XX would be any Arabian number or English letter or blank) and PWB1085 are identical schematics, Model PWB1085 was selected for fully testing, the detailed information can be referred to the declaration which was stated and guaranteed by the applicant.

Objective

This report is prepared on behalf of *Ubio Labs, Inc.* in accordance with Part 2, Subpart J, and Part 15, Subparts A and C of the Federal Communications Commission's rules.

The objective is to determine the compliance of EUT with FCC rules, section 15.203, 15.205, 15.207 and 15.209.

Related Submittal(s)/Grant(s)

No Related Submittal(s)/Grant(s).

Test Methodology

All measurements contained in this report were conducted with ANSI C63.10-2013, American National Standard of Procedures for Compliance Testing of Unlicensed Wireless Devices.

All emissions measurement was performed at Bay Area Compliance Laboratories Corp. (Shenzhen). The radiated testing was performed at an antenna-to-EUT distance of 3 meters.

Measurement Uncertainty

Item		Uncertainty
AC Power Line Conducted Emissions		±1.95 dB
Radiated emission	9 kHz~30MHz	±4.52 dB
	30MHz~1 GHz	±5.81 dB
Occupied Bandwidth		±0.5 kHz
Temperature		±3.0 °C
Humidity		±6 %

Note: The extended uncertainty given in this report is obtained by combining the standard uncertainty times the coverage factor K with the 95% confidence interval. Otherwise required by the applicant or Product Regulations, Decision Rule in this report did not consider the uncertainty.

Test Facility

The Test site used by Bay Area Compliance Laboratories Corp. (Shenzhen) to collect test data is located on the 6/F., West Wing, Third Phase of Wanli Industrial Building, Shihua Road, Futian Free Trade Zone, Shenzhen, Guangdong, China.

The test site has been approved by the FCC under the KDB 974614 D01 and is listed in the FCC Public Access Link (PAL) database, FCC Registration No.: 342867, the FCC Designation No.: CN1221.

The test site has been registered with ISED Canada under ISED Canada Registration Number 3062B.

SYSTEM TEST CONFIGURATION

Justification

The system was configured for testing in a test mode

The device is a wireless charger operation on frequency 110 kHz - 205 kHz.

EUT Exercise Software

No software used in test.

Support Equipment List and Details

Manufacturer	Description	Model	Serial Number
Unknown	Load 1	Unknown	Unknown
Unknown	Load 2	Unknown	Unknown
Unknown	Wireless load	Unknown	Unknown
Groovy	Adapter	G181104	Unknown

External I/O Cable

Cable Description	Length (m)	From Port	To
Un-shield Detachable Lightning Cable	1.0	Adapter	EUT
Un-shield Detachable USB Cable	0.2	EUT	Load 1
Un-shield Detachable Type C Cable	0.2	EUT	Load 2

Block Diagram of Test Setup

For conducted emission:

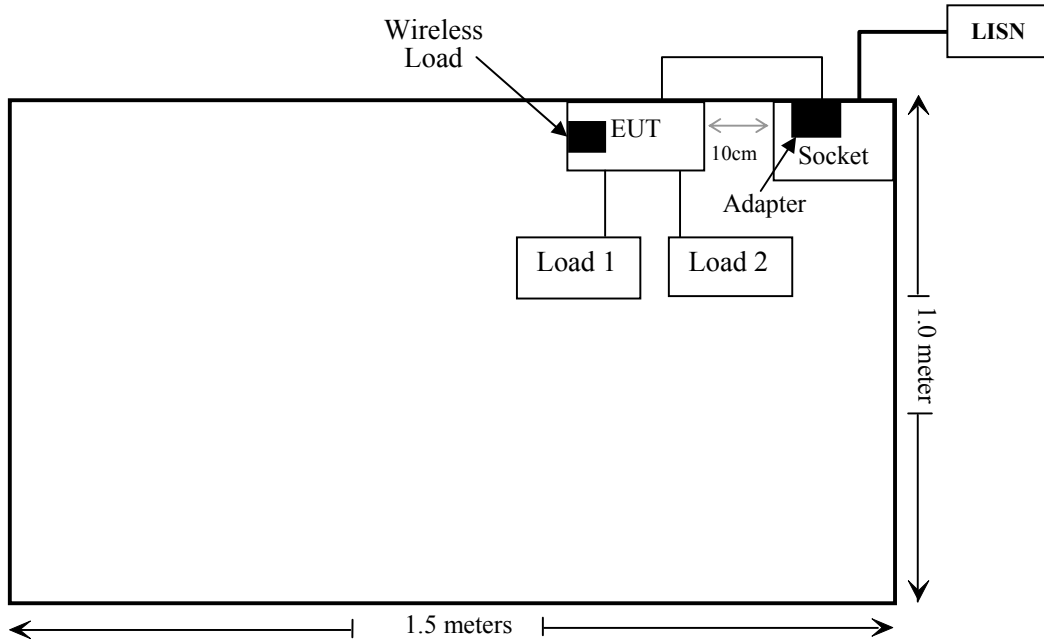

SUMMARY OF TEST RESULTS

FCC Rules	Description of Test	Result
FCC§1.1310 & §2.1091	Maximum Permissible Exposure(MPE)	Compliance
FCC§15.203	Antenna Requirement	Compliance
FCC§15.207	AC Line Conducted Emission	Compliance
§15.209 §15.205	Radiated Emission Test	Compliance

TEST EQUIPMENT LIST

Manufacturer	Description	Model	Serial Number	Calibration Date	Calibration Due Date
MPE					
Narda	Exposure Level Tester	ELT-400	N-0229	2019/11/15	2021/11/15
Narda	B Field Probe	ELT Probe 100cm ²	M-0666	2019/11/15	2021/11/15
ETS-Lindgreen	Isotropic Field Probe	HI-6005	69461	2018-9-28	2021-9-27
Conducted Emissions Test					
Rohde & Schwarz	EMI Test Receiver	ESCI	101120	2019/7/9	2020/7/8
Rohde & Schwarz	LISN	ENV216	101613	2019/1/25	2020/1/24
Rohde & Schwarz	Transient Limitor	ESH3Z2	DE25985	2019/11/29	2020/11/28
/	CE Cable	CE Cable	UF A210B-1- 0720-504504	2019/11/29	2020/11/28
Rohde & Schwarz	CE Test software	EMC 32	V8.53.0	NCR	NCR
RF Radiated test					
R&S	EMI Test Receiver	ESR3	102455	2019/7/9	2020/7/8
Sonoma instrument	Pre-amplifier	310 N	186238	2019/4/20	2020/4/20
Sunol Sciences	Broadband Antenna	JB1	A040904-1	2017/12/22	2020/12/21
ETS	Passive Loop Antenna	6512	29604	2018/7/14	2021/7/13
Rohde & Schwarz	Auto test software	EMC 32	V9.10	NCR	NCR
/	Cable 2	RF Cable 2	/	2019/11/29	2020/11/28
/	Cable	Chamber Cable 1	/	2019/11/29	2020/11/28
/	Cable	Chamber Cable 4	EC-007	2019/11/29	2020/11/28
Rohde & Schwarz	Auto test software	EMC 32	V9.10	NCR	NCR

* **Statement of Traceability:** Bay Area Compliance Laboratories Corp. (Shenzhen) attests that all calibrations have been performed in accordance to requirements that traceable to National Primary Standards and International System of Units (SI).

FCC §1.1310, §2.1091- MAXIMUM PERMISSIBLE EXPOSURE (MPE)

Applicable Standard

According to subpart §1.1310, systems operating under the provisions of this section shall be operated in a manner that ensures that the public is not exposed to radio frequency energy level in excess of the Commission's guidelines.

Limits for Maximum Permissible Exposure (MPE) (§1.1310, §2.1091)

(B) Limits for General Population/Uncontrolled Exposure				
Frequency Range (MHz)	Electric Field Strength (V/m)	Magnetic Field Strength (A/m)	Power Density (mW/cm²)	Averaging Time (minutes)
0.3–1.34	614	1.63	*(100)	30
1.34–30	824/f	2.19/f	*(180/f ²)	30
30–300	27.5	0.073	0.2	30
300–1500	/	/	f/1500	30
1500–100,000	/	/	1.0	30

f = frequency in MHz; * = Plane-wave equivalent power density;

According with KDB 680106 D01 RF Exposure Wireless Charging Apps v03 clause 3 c)

- c) For devices designed for typical desktop applications, such as wireless charging pads, RF exposure evaluation should be conducted assuming a user separation distance of 15 cm. E and H field strength measurements or numerical modeling may be used to demonstrate compliance. Measurements should be made from all sides and the top of the primary/client pair, with the 15 cm measured from the center of the probe(s) to the edge of the device. Emissions between 100 kHz to 300 kHz should be assessed versus the limits at 300 kHz in Table 1 of Section 1.1310: 614 V/m and 1.63 A/m. A KDB inquiry is required to determine the applicable exposure limits below 100 kHz.

According to KDB 680106 D01 RF Exposure Wireless Charging App v03 clause 5 b)

- b) Inductive wireless power transfer applications with supporting field strength results and meeting all of the following requirements are not required to submit a KDB inquiry for devices approved using SDoC or a PAG for equipment approved using certification to address RF exposure compliance. However, the responsible party is required to keep a copy of the test report in accordance with KDB 865664 D02. A copy of the test report is to be submitted with the application if the device is approved using certification.
- (1) Power transfer frequency is less than 1 MHz.
 - (2) Output power from each primary coil is less than or equal to 15 watts.
 - (3) The transfer system includes only single primary and secondary coils. This includes charging systems that may have multiple primary coils and clients that are able to detect and allow coupling only between individual pairs of coils.
 - (4) Client device is placed directly in contact with the transmitter.
 - (5) Mobile exposure conditions only (portable exposure conditions are not covered by this exclusion).
 - (6) The aggregate H-field strengths at 15 cm surrounding the device and 20 cm above the top surface from all simultaneous transmitting coils are demonstrated to be less than 50% of the MPE limit.

Block Diagram of Test Setup

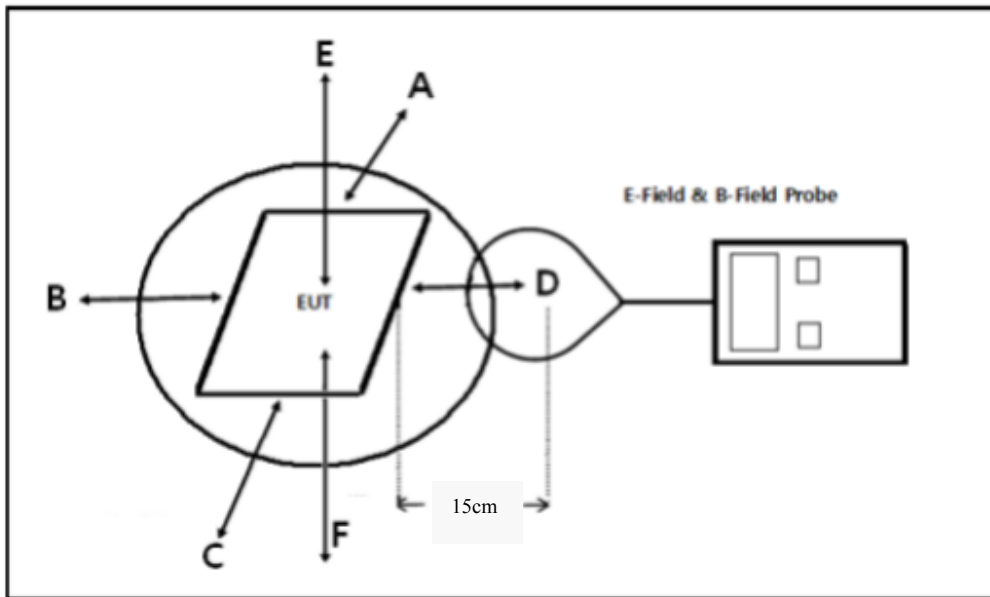

Note: 20 cm for Top test.

Test Data

Environmental Conditions

Temperature:	25°C
Relative Humidity:	65 %
ATM Pressure:	101.0 kPa

The testing was performed by Yates Li on 2020-01-10.

Test mode: Transmitting & discharging (full load)

H-Filed Strength

Frequency Range (kHz)	Position A (A/m)	Position B (A/m)	Position C (A/m)	Position D (A/m)	Position E (A/m)	50% Limit (A/m)	Limit Test (A/m)
110-205	0.130	0.123	0.124	0.126	0.135	0.815	1.63

E-Filed Strength

Frequency Range (kHz)	Position A (V/m)	Position B (V/m)	Position C (V/m)	Position D (V/m)	Position E (V/m)	50% Limit (V/m)	Limit Test (V/m)
110-205	0.601	0.564	0.631	0.660	0.544	302	604

Note: Test with 15cm distance from the center of the probe(s) to the edge of the device, 20 cm for top test.

Result: Compliance**Considerations of compliance 680106 D01 RF Exposure Wireless Charging App v03 clause 5 b:**

(1) Power transfer frequency is less than 1 MHz.

Yes, the operation frequency is 110-205 kHz.

(2) Output power from each primary coil is less than or equal to 15 watts.

Yes, the maximum output power of primary coil is 5 Watts, less than 15 watts.

(3) The transfer system includes only single primary and secondary coils. This includes charging systems that may have multiple primary coils and clients that are able to detect and allow coupling only between individual pairs of coils.

The transfer system includes only single primary coils to detect and allow coupling only between individual pairs of coils.

(4) Client device is placed directly in contact with the transmitter.

Yes, client device is placed directly in contact with the transmitter

(5) Mobile exposure conditions only (portable exposure conditions are not covered by this exclusion).

Yes, mobile exposure conditions only

(6) The aggregate H-field strengths at 15 cm surrounding the device and 20 cm above the top surface from all simultaneous transmitting coils are demonstrated to be less than 50% of the MPE limit.

Yes, the test result for H and E-filed strength less than 50% of the MPE limit.

FCC§15.203 – ANTENNA REQUIREMENT

Applicable Standard

An intentional radiator shall be designed to ensure that no antenna other than that furnished by the responsible party shall be used with the device. The use of a permanently attached antenna or of an antenna that uses a unique coupling to the intentional radiator shall be considered sufficient to comply with the provisions of this section.

Antenna Connected Construction

The EUT has a coil antenna arrangement, which was permanently attached, fulfill the requirement of this section. Please refer to the EUT photos.

Result: Compliance.

FCC §15.207 – AC LINE CONDUCTED EMISSION

Applicable Standard

FCC§15.207

EUT Setup

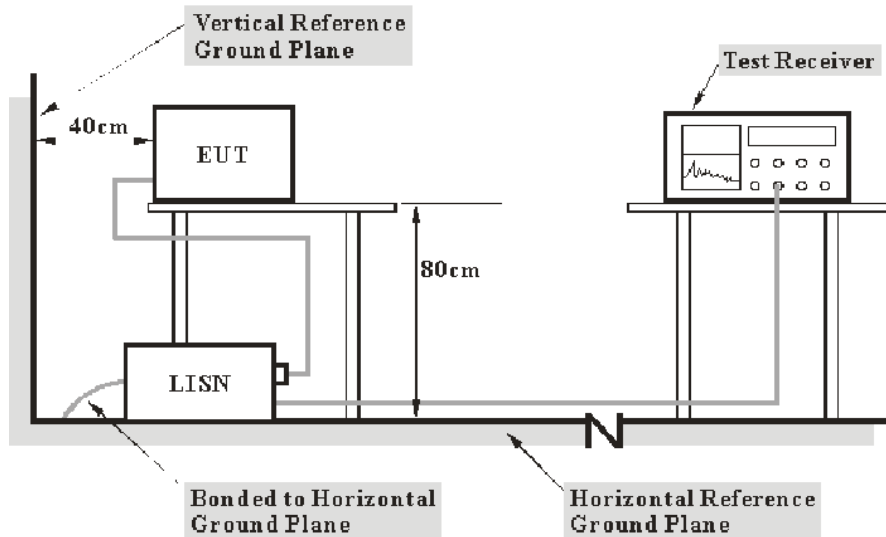

- Note: 1. Support units were connected to second LISN.
 2. Both of LISNs (AMN) 80 cm from EUT and at the least 80 cm from other units and other metal planes support units.

The setup of EUT is according with per ANSI C63.10-2013 measurement procedure. The specification used was with the FCC Part 15.207 limits.

The spacing between the peripherals was 10 cm.

EMI Test Receiver Setup

The EMI test receiver was set to investigate the spectrum from 150 kHz to 30 MHz.

During the conducted emission test, the EMI test receiver was set with the following configurations:

Frequency Range	IF B/W
150 kHz – 30 MHz	9 kHz

Test Procedure

During the conducted emission test, the adapter was connected to the outlet of the LISN.

Maximizing procedure was performed on the six (6) highest emissions of the EUT.

All final data was recorded in the Quasi-peak and average detection mode.

Corrected Factor & Margin Calculation

The Corrected factor is calculated by adding LISN VDF (Voltage Division Factor), Cable Loss and Transient Limiter Attenuation. The basic equation is as follows:

$$\text{Correction Factor} = \text{LISN VDF} + \text{Cable Loss} + \text{Transient Limiter Attenuation}$$

The “**Margin**” column of the following data tables indicates the degree of compliance with the applicable limit. For example, a margin of 7 dB means the emission is 7 dB below the limit. The equation for margin calculation is as follows:

$$\text{Margin} = \text{Limit} - \text{Corrected Amplitude}$$

Test Results Summary

According to the recorded data in following table, the EUT complied with the FCC Part 15.207,

Test Data

Environmental Conditions

Temperature:	25°C
Relative Humidity:	65 %
ATM Pressure:	101.0 kPa

The testing was performed by Haiguo Li on 2020-01-03.

Test Mode: Charging & transmitting & discharging (full load)

AC 120 V/60 Hz, Line:

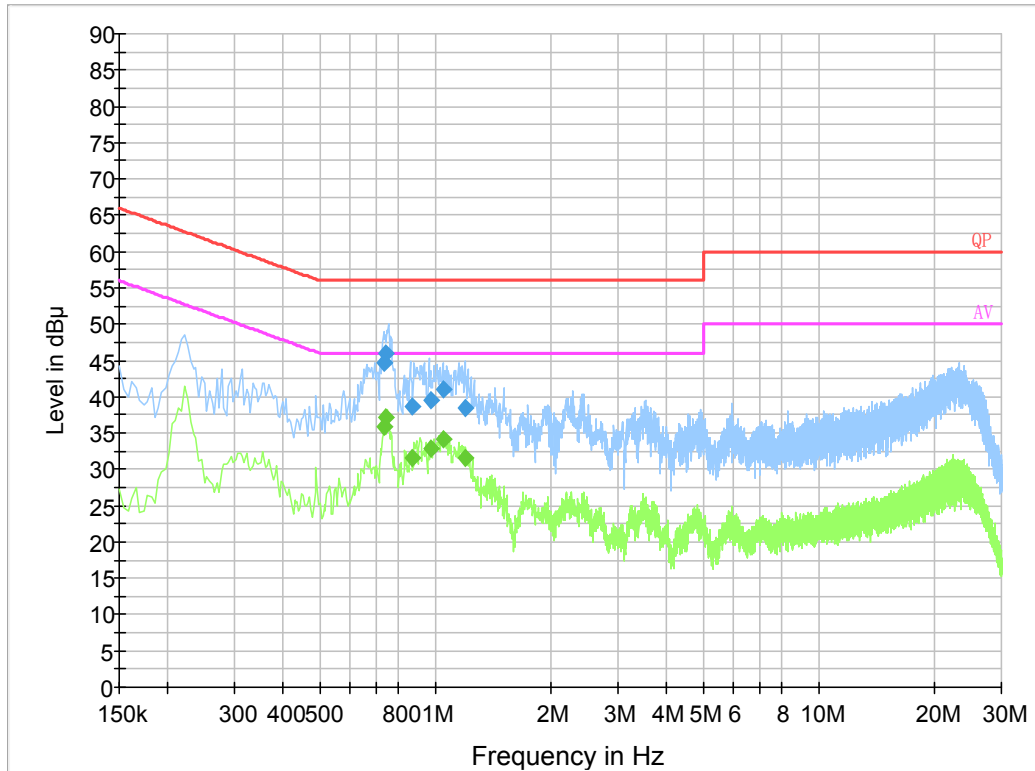

Frequency (MHz)	Corrected Amplitude (dBμV)	Correction Factor (dB)	Limit (dBμV)	Margin (dB)	Detector (PK/Ave./QP)
0.734990	44.8	19.8	56.0	11.2	QP
0.746630	45.9	19.8	56.0	10.1	QP
0.874930	38.7	19.8	56.0	17.3	QP
0.975570	39.5	19.9	56.0	16.5	QP
1.050250	41.1	19.9	56.0	14.9	QP
1.204030	38.4	19.8	56.0	17.6	QP
0.734990	35.8	19.8	46.0	10.2	Ave.
0.746630	37.1	19.8	46.0	8.9	Ave.
0.874930	31.5	19.8	46.0	14.5	Ave.
0.975570	33.0	19.9	46.0	13.0	Ave.
1.050250	34.2	19.9	46.0	11.8	Ave.
1.204030	31.5	19.8	46.0	14.5	Ave.

AC 120V/ 60 Hz, Neutral:

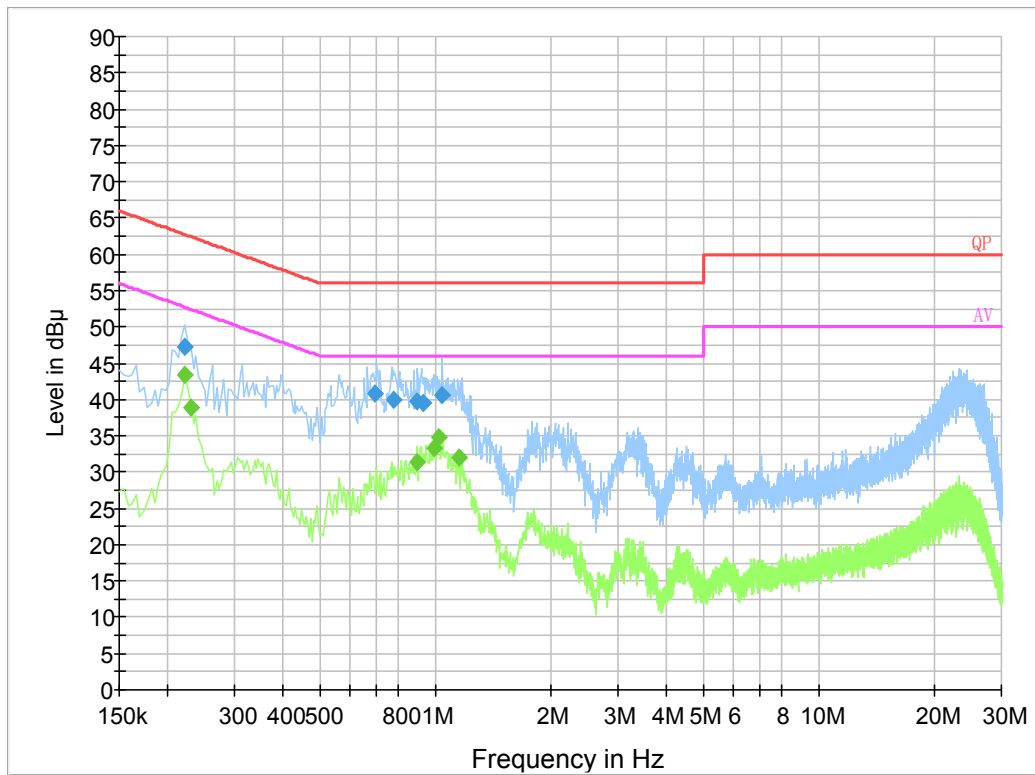

Frequency (MHz)	Corrected Amplitude (dBμV)	Correction Factor (dB)	Limit (dBμV)	Margin (dB)	Detector (PK/Ave./QP)
0.221500	47.2	19.8	62.8	15.6	QP
0.695410	40.7	19.8	56.0	15.3	QP
0.781550	39.9	19.8	56.0	16.1	QP
0.896530	39.8	19.7	56.0	16.2	QP
0.932170	39.5	19.8	56.0	16.5	QP
1.046310	40.6	19.8	56.0	15.4	QP
0.222000	43.3	19.8	52.7	9.4	Ave.
0.230000	38.8	19.8	52.4	13.6	Ave.
0.898000	31.4	19.7	46.0	14.6	Ave.
0.994000	33.4	19.8	46.0	12.6	Ave.
1.022000	34.9	19.8	46.0	11.1	Ave.
1.150000	32.0	19.8	46.0	14.0	Ave.

Note:

- 1) Correction Factor = LISN VDF (Voltage Division Factor) + Cable Loss + Transient Limiter Attenuation
- 2) Corrected Amplitude = Reading + Correction Factor
- 3) Margin = Limit - Corrected Amplitude

FCC §15.205 & §15.209 - RADIATED EMISSIONS TEST

Applicable Standard

As per FCC Part 15.209

(a) Except as provided elsewhere in this subpart, the emissions from an intentional radiator shall not exceed the field strength levels specified in the following table:

Frequency (MHz)	Field strength (microvolts/meter)	Measurement distance (meters)
0.009-0.490	2400/F(kHz)	300
0.490-1.705	24000/F(kHz)	30
1.705-30.0	30	30
30-88	100**	3
88-216	150**	3
216-960	200**	3
Above 960	500	3

**Except as provided in paragraph (g), fundamental emissions from intentional radiators operating under this section shall not be located in the frequency bands 54-72 MHz, 76-88 MHz, 174-216 MHz or 470-806 MHz. However, operation within these frequency bands is permitted under other sections of this part, e.g., §§15.231 and 15.241.

EUT Setup

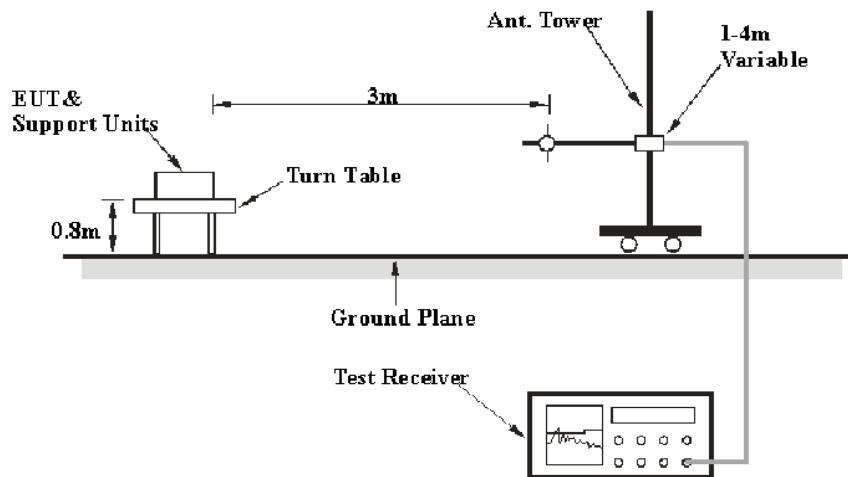

The radiated emission tests were performed in the 3-meter chamber test site, using the setup accordance with the ANSI C63.10-2013. The specification used was the FCC Part Subpart C limits.

The spacing between the peripherals was 10 cm.

EMI Test Receiver Setup

The system was investigated from 9 kHz to 1 GHz.

During the radiated emission test, the EMI test Receiver was set with the following configurations:

Frequency Range	RBW	Video B/W	Measurement
9 kHz – 150 kHz	200 Hz	1 kHz	QP/Average
150 kHz – 30 MHz	9 kHz	30 kHz	QP/Average
30 MHz – 1000 MHz	120 kHz	300 kHz	QP

The emission limits shown in the above table are based on measurements employing a CISPR quasi-peak detector except for the frequency bands 9-90 kHz, 110-490 kHz and above 1000 MHz. Radiated emission limits in these three bands are based on measurements employing an average detector.

If the maximized peak measured value complies with the limit, then it is unnecessary to perform an QP/Average measurement

Corrected Amplitude & Margin Calculation

The Corrected Amplitude is calculated by adding the Antenna Factor and Cable Loss, and subtracting the Amplifier Gain from the Amplitude reading. The basic equation is as follows:

$$\text{Corr. Ampl.} = \text{Meter Reading} + \text{Antenna Factor} + \text{Cable Loss} - \text{Amplifier Gain}$$

The “**Margin**” column of the following data tables indicates the degree of compliance with the applicable limit. For example, a margin of 7dB means the emission is 7dB below the limit. The equation for margin calculation is as follows:

$$\text{Margin} = \text{Limit} - \text{Corr. Ampl.}$$

Test Results Summary

According to the data in the following table, the EUT complied with the FCC Part 15.209&15.205.

Test Data

Environmental Conditions

Temperature:	25 °C
Relative Humidity:	65 %
ATM Pressure:	101.0 kPa

The testing was performed by Zero Yan on 2020-01-04 and Zero Yan on 2020-01-10.

Test mode: Charging & transmitting & discharging (full load)

1) 9 kHz~30MHz:

Frequency (MHz)	Corrected Amplitude (dBμV/m)	Detector (PK/QP/AV)	Turntable Degree	Rx Antenna		Corrected Factor (dB/m)	FCC Part 15.205&15.209		Remark
				Height (m)	Polar		Limit (dBμV/m)	Margin (dB)	
0.00971	28.91	PK	125	1.0	H	87.9	127.86	98.95	Spurious emission
0.13255	40.22	PK	82	1.0	H	64.2	105.16	64.94	
0.258	63.77	PK	59	1.0	H	57.8	99.37	35.60	
0.388	59.82	PK	210	1.0	H	56.4	95.83	36.01	
14.427	57.54	PK	151	1.0	H	32.2	69.54	12.00	
28.207	54.37	PK	69	1.0	H	31.1	69.54	15.17	
0.13051	70.76	PK	24	1.0	H	64.3	105.29	34.53	Fundamental

NOTE: PK detector data compliance with average detector limit.

9 kHz-150 kHz

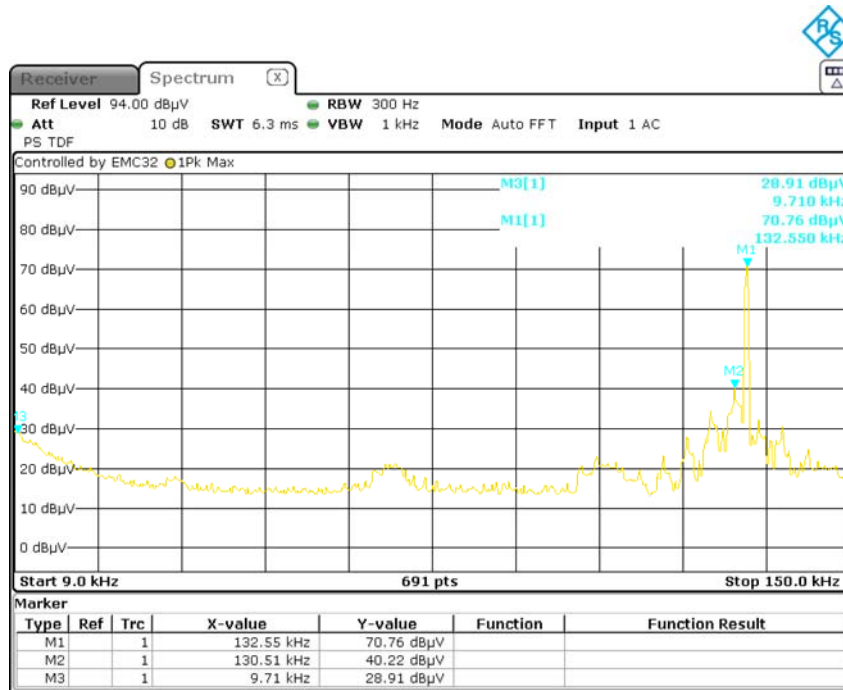

Date: 10.JAN.2020 08:46:54

150 kHz-30 MHz

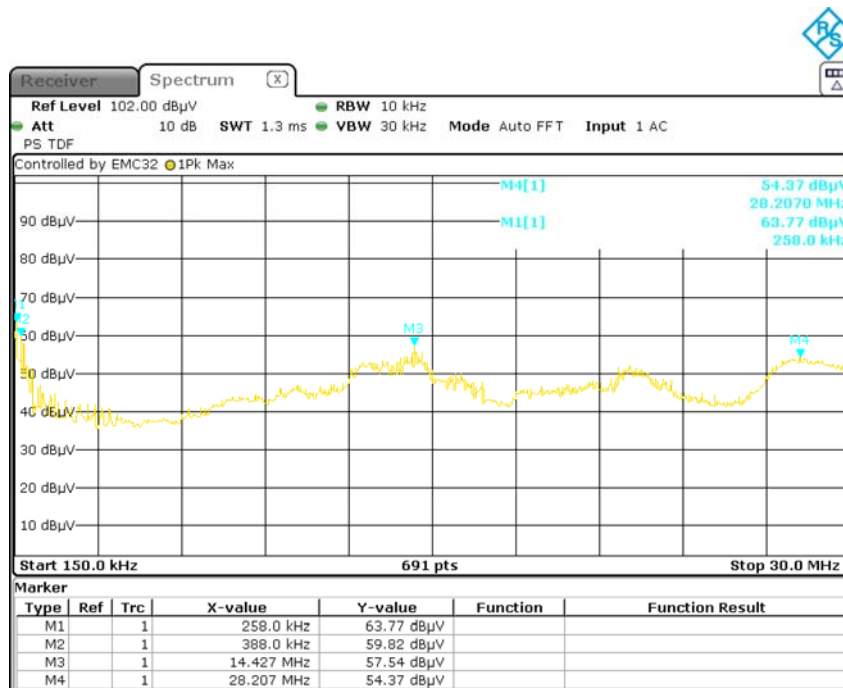

Date: 10.JAN.2020 08:53:27

2) 30 MHz ~ 1GHz

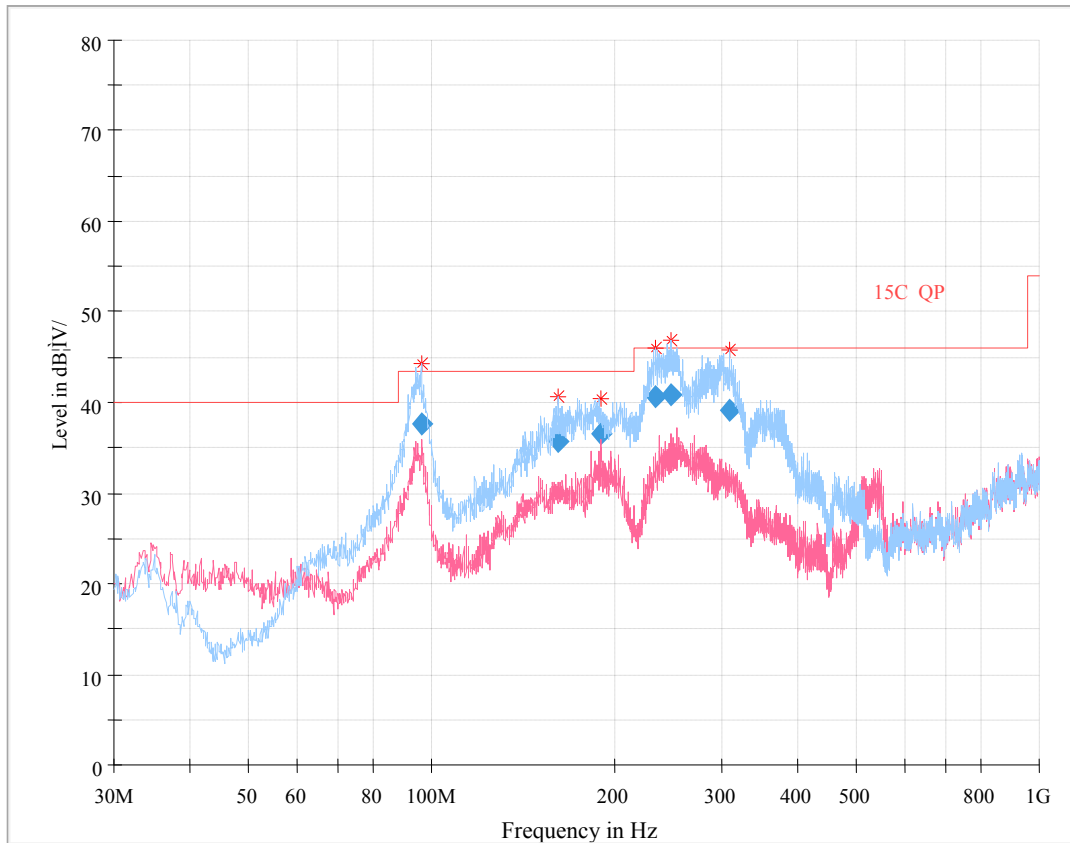

Frequency (MHz)	Corrected Amplitude (dBµV/m)	Antenna height (cm)	Antenna Polarity	Turntable position (degree)	Correction Factor (dB/m)	Limit (dBµV/m)	Margin (dB)
96.182125	37.63	154.0	H	138.0	-17.9	43.50	5.87
161.857875	35.54	262.0	H	182.0	-14.5	43.50	7.96
189.335375	36.88	307.0	H	187.0	-15.2	43.50	6.32
234.084125	40.39	181.0	H	203.0	-14.0	46.00	5.61
247.547250	40.73	260.0	H	200.0	-14.1	46.00	5.27
308.497000	39.04	109.0	H	182.0	-10.7	46.00	6.96

Note:

Corrected Amplitude = Corrected Factor + Reading

Corrected Factor=Antenna factor (RX) + cable loss - amplifier factor

Margin = Limit- Corr. Amplitude

Result: Compliance

***** END OF REPORT *****