



TESTING LABORATORY
CERTIFICATE #4820.01



FCC PART 15.247 TEST REPORT

For

New Times Global Limited

RM3410, Hong Kin House, Tsz Hong EST, Tsz Wan Shan, Kowloon, HK

FCC ID: 2ATG5-NT-B809

Report Type: Original Report	Product Name: Bluetooth Speaker
Report Number:	RDG201215008-00A
Report Date:	2021-01-12
Reviewed By:	Ivan Cao Assistant Manager 
Test Laboratory:	Bay Area Compliance Laboratories Corp. (Dongguan) No.12, Pulong East 1 st Road, Tangxia Town, Dongguan, Guangdong, China Tel: +86-769-86858888 Fax: +86-769-86858891 www.baclcorp.com.cn

TABLE OF CONTENTS

GENERAL INFORMATION.....	4
PRODUCT DESCRIPTION FOR EQUIPMENT UNDER TEST (EUT).....	4
OBJECTIVE	4
RELATED SUBMITTAL(S)/GRANT(S).....	4
TEST METHODOLOGY	4
MEASUREMENT UNCERTAINTY	5
TEST FACILITY	5
DECLARATIONS.....	5
SYSTEM TEST CONFIGURATION.....	6
DESCRIPTION OF TEST CONFIGURATION	6
EQUIPMENT MODIFICATIONS	6
EUT EXERCISE SOFTWARE	6
SUPPORT EQUIPMENT LIST AND DETAILS	7
SUPPORT CABLE LIST AND DETAILS	7
BLOCK DIAGRAM OF TEST SETUP	8
SUMMARY OF TEST RESULTS.....	9
FCC §15.247 (i) & §1.1310 & §2.1091- MAXIMUM PERMISSIBLE EXPOSURE (MPE).....	10
APPLICABLE STANDARD	10
FCC §15.203 - ANTENNA REQUIREMENT.....	11
APPLICABLE STANDARD	11
ANTENNA INFORMATION AND CONNECTOR CONSTRUCTION.....	11
FCC §15.207 (a)– AC LINE CONDUCTED EMISSIONS	12
APPLICABLE STANDARD	12
EUT SETUP.....	12
EMI TEST RECEIVER SETUP.....	12
TEST PROCEDURE	13
CORRECTED AMPLITUDE & MARGIN CALCULATION	13
TEST EQUIPMENT LIST AND DETAILS.....	14
TEST DATA	14
FCC §15.209, §15.205, §15.247(d) - Spurious Emissions.....	17
APPLICABLE STANDARD	17
EUT SETUP.....	17
EMI TEST RECEIVER & SPECTRUM ANALYZER SETUP	18
TEST PROCEDURE	18
CORRECTED AMPLITUDE & MARGIN CALCULATION	18
TEST EQUIPMENT LIST AND DETAILS.....	19
TEST DATA	19
FCC §15.247(a) (2) –6 dB EMISSION BANDWIDTH.....	25
APPLICABLE STANDARD	25
TEST PROCEDURE	25
TEST EQUIPMENT LIST AND DETAILS.....	25
TEST DATA	25
FCC §15.247(b) (3) - Maximum Peak Conducted Output Power.....	28
APPLICABLE STANDARD	28

TEST PROCEDURE28
TEST EQUIPMENT LIST AND DETAILS.....28
TEST DATA28

FCC §15.247(d) – 100 kHz Bandwidth of Frequency Band Edge30
APPLICABLE STANDARD30
TEST PROCEDURE30
TEST EQUIPMENT LIST AND DETAILS.....30
TEST DATA30

FCC §15.247(e) - Power Spectral Density.....32
APPLICABLE STANDARD32
TEST PROCEDURE32
TEST EQUIPMENT LIST AND DETAILS.....32
TEST DATA32

GENERAL INFORMATION

Product Description for Equipment under Test (EUT)

EUT Name:	Bluetooth Speaker
EUT Model:	NT-B809
Multiple Model:	NT-B812, NT-B815, NT-B817, ISBW301
Operation Frequency:	2402-2480MHz
Maximum Peak Output Power (Conducted):	4.15 dBm
Modulation Type:	GFSK
Antenna Gain▲:	3.0 dBi
Rated Input Voltage:	DC 3.7V from battery or DC 5V from USB port
Serial Number:	RDG201215008-RF-S1
EUT Received Date:	2020.12.16
EUT Received Status:	Good

Note: The series product, models NT-B812, NT-B815, NT-B817, ISBW301 are electrically identical. Model: NT-B809 was selected for full test. The difference between them please refers to the declaration letter for details.

Objective

This report is prepared on behalf of **New Times Global Limited** in accordance with Part 2, Subpart J, Part 15, Subparts A and C of the Federal Communications Commission's rules

The tests were performed in order to determine the compliance of the EUT with FCC Rules Part 15-Subpart C, section 15.203, 15.205, 15.207, 15.209, 15.247 rules.

Related Submittal(s)/Grant(s)

FCC Part 15C DSS submissions with FCC ID: 2ATG5-NT-B809

Test Methodology

All measurements contained in this report were conducted with ANSI C63.10-2013, American National Standard of Procedures for Compliance Testing of Unlicensed Wireless Devices and KDB 558074 D01 DTS Meas Guidance v05r02.

All emissions measurement was performed and Bay Area Compliance Laboratories Corp. (Dongguan).

Measurement Uncertainty

Parameter	Measurement Uncertainty
Occupied Channel Bandwidth	±5 %
RF output power, conducted	±0.61dB
Power Spectral Density, conducted	±0.61 dB
Unwanted Emissions, radiated	30M~200MHz: 4.55 dB, 200M~1GHz: 5.92 dB, 1G~6GHz: 4.98 dB, 6G~18GHz: 5.89 dB, 18G~26.5G: 5.47 dB, 26.5G~40G: 5.63 dB
Unwanted Emissions, conducted	±1.5 dB
Temperature	±1 °C
Humidity	±5%
DC and low frequency voltages	±0.4%
Duty Cycle	1%
AC Power Lines Conducted Emission	3.12 dB (150 kHz to 30 MHz)

Note: Otherwise required by the applicant or Product Regulations, Decision Rule in this report did not consider the uncertainty. The extended uncertainty given in this report is obtained by combining the standard uncertainty times the coverage factor K with the 95% confidence interval.

Test Facility

The Test site used by Bay Area Compliance Laboratories Corp. (Dongguan) to collect test data is located on the No.69 Pulongcun, Puxinhu Industry Area, Tangxia, Dongguan, Guangdong, China.

The lab has been recognized as the FCC accredited lab under the KDB 974614 D01 and is listed in the FCC Public Access Link (PAL) database, FCC Registration No. : 897218, the FCC Designation No. : CN1220.

The lab has been recognized by Innovation, Science and Economic Development Canada to test to Canadian radio equipment requirements, the CAB identifier: CN0022.

Declarations

BACL is not responsible for the authenticity of any test data provided by the applicant. Data included from the applicant that may affect test results are marked with a triangle symbol “▲”. Customer model name, addresses, names, trademarks etc. are not considered data.

Unless otherwise stated the results shown in this test report refer only to the sample(s) tested.

This report cannot be reproduced except in full, without prior written approval of the Company.

This report is valid only with a valid digital signature. The digital signature may be available only under the Adobe software above version 7.0.

This report may contain data that are not covered by the accreditation scope and shall be marked with an asterisk “★”.

SYSTEM TEST CONFIGURATION

Description of Test Configuration

The system was configured for testing in RF Transmitting mode.

For Bluetooth LE mode, 40 channels are provided for testing:

Channel	Frequency (MHz)	Channel	Frequency (MHz)
0	2402	20	2442
1	2404
...
...
..	...	38	2478
19	2440	39	2480

EUT was tested with channel 0, 19 and 39.

Equipment Modifications

No modification was made to the EUT tested.

EUT Exercise Software

The software: ' FCCAssist2.4 ' was used during test, which was provided by manufacturer. The maximum power level was configured by the software as below table▲:

Channel	Test Frequency (MHz)	Power level Setting
Low	2402	6
Middle	2440	6
High	2480	6

The duty cycle as below:

T _{on} (ms)	T _{on+off} (ms)	Duty Cycle (%)
0.229	0.630	36.35

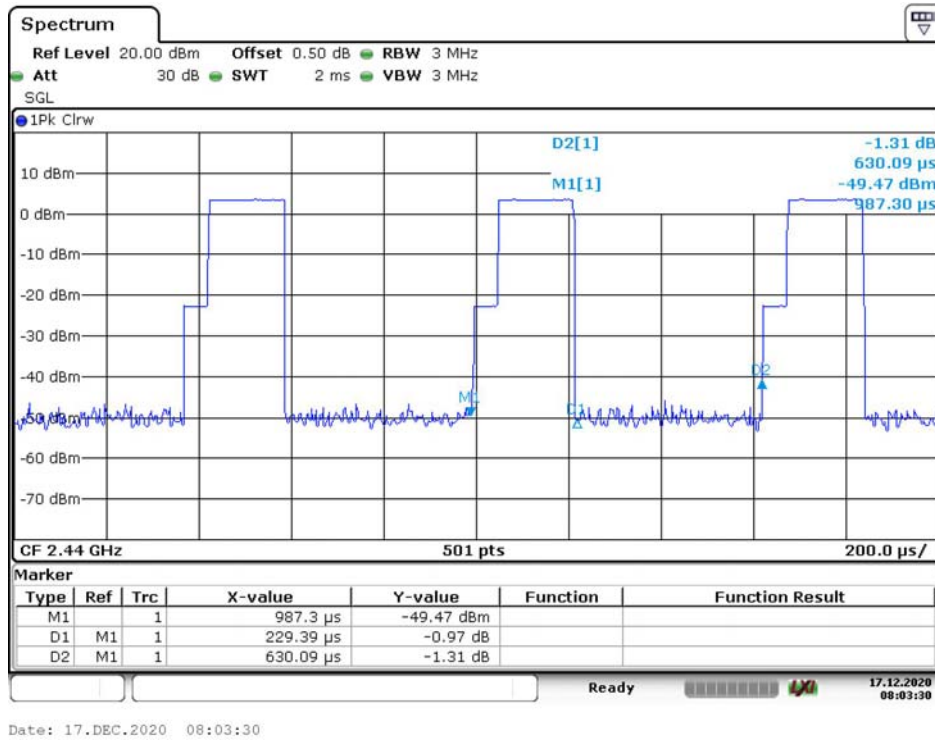

Support Equipment List and Details

Manufacturer	Description	Model	Serial Number
SanDisk	Micro SD Card	UHS-I-128G	9292DVDSV0XZ
HUAWEI	AC/DC Adapter	HW-050200C01	P78546GBS27859

Support Cable List and Details

Cable Description	Shielding Type	Ferrite Core	Length (m)	From Port	To
USB Cable	Yes	No	0.5	EUT	Adapter

Block Diagram of Test Setup

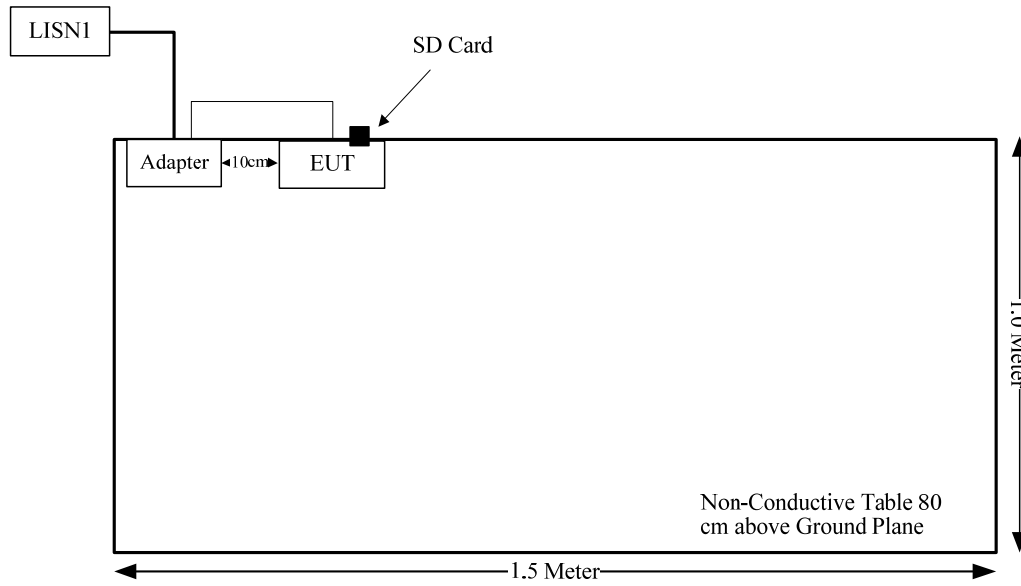

SUMMARY OF TEST RESULTS

FCC Rules	Description of Test	Result
§15.247 (i) & §1.1310 & §2.1091	Maximum Permissible Exposure (MPE)	Compliance
§15.203	Antenna Requirement	Compliance
§15.207 (a)	AC Line Conducted Emissions	Compliance
§15.205, §15.209, §15.247(d)	Spurious Emissions	Compliance
§15.247 (a)(2)	6 dB Bandwidth	Compliance
§15.247(b)(3)	Maximum Conducted Output Power	Compliance
§15.247(d)	100 kHz Bandwidth of Frequency Band Edge	Compliance
§15.247(e)	Power Spectral Density	Compliance

FCC §15.247 (i) & §1.1310 & §2.1091- MAXIMUM PERMISSIBLE EXPOSURE (MPE)

Applicable Standard

According to subpart 15.247(i) and subpart §1.1310, systems operating under the provisions of this section shall be operated in a manner that ensures that the public is not exposed to radio frequency energy level in excess of the Commission’s guidelines.

Limits for Maximum Permissible Exposure (MPE) (§1.1310, §2.1091)

(B) Limits for General Population/Uncontrolled Exposure				
Frequency Range (MHz)	Electric Field Strength (V/m)	Magnetic Field Strength (A/m)	Power Density (mW/cm²)	Averaging Time (minutes)
0.3–1.34	614	1.63	*(100)	30
1.34–30	824/f	2.19/f	*(180/f ²)	30
30–300	27.5	0.073	0.2	30
300–1500	/	/	f/1500	30
1500–100,000	/	/	1.0	30

f = frequency in MHz; * = Plane-wave equivalent power density;

According to §1.1310 and §2.1091 RF exposure is calculated.

Calculation formula:

Prediction of power density at the distance of the applicable MPE limit

$S = PG/4\pi R^2$ = power density (in appropriate units, e.g. mW/cm²);

P = power input to the antenna (in appropriate units, e.g., mW);

G = power gain of the antenna in the direction of interest relative to an isotropic radiator, the power gain factor, is normally numeric gain;

R = distance to the center of radiation of the antenna (appropriate units, e.g., cm);

Calculated Data:

Frequency (MHz)	Antenna Gain		Conducted output power including Tune-up Tolerance		Evaluation Distance (cm)	Power Density (mW/cm ²)	MPE Limit (mW/cm ²)
	(dBi)	(numeric)	(dBm)	(mW)			
2402-2480	3	2.00	5	3.16	20.00	0.001	1.0

Result: The device meet FCC MPE at 20 cm distance

FCC §15.203 - ANTENNA REQUIREMENT

Applicable Standard

According to § 15.203, an intentional radiator shall be designed to ensure that no antenna other than that furnished by the responsible party shall be used with the device. The use of a permanently attached antenna or of an antenna that uses a unique coupling to the intentional radiator shall be considered sufficient to comply with the provisions of this section. The manufacturer may design the unit so that a broken antenna can be replaced by the user, but the user of a standard antenna jack or electrical connector is prohibited. The structure and application of the EUT were analyzed to determine compliance with section §15.203 of the rules. §15.203 state that the subject device must meet the following criteria:

- a. Antenna must be permanently attached to the unit.
- b. Antenna must use a unique type of connector to attach to the EUT.
- c. Unit must be professionally installed, and installer shall be responsible for verifying that the correct antenna is employed with the unit.

Antenna Information And Connector Construction

The EUT has one internal PCB antenna arrangement for BT, and the antenna gain is 3.0 dBi, fulfill the requirement of this section. Please refer to the EUT photos.

Result: Compliance.

FCC §15.207 (a)– AC LINE CONDUCTED EMISSIONS

Applicable Standard

FCC§15.207(a)

EUT Setup

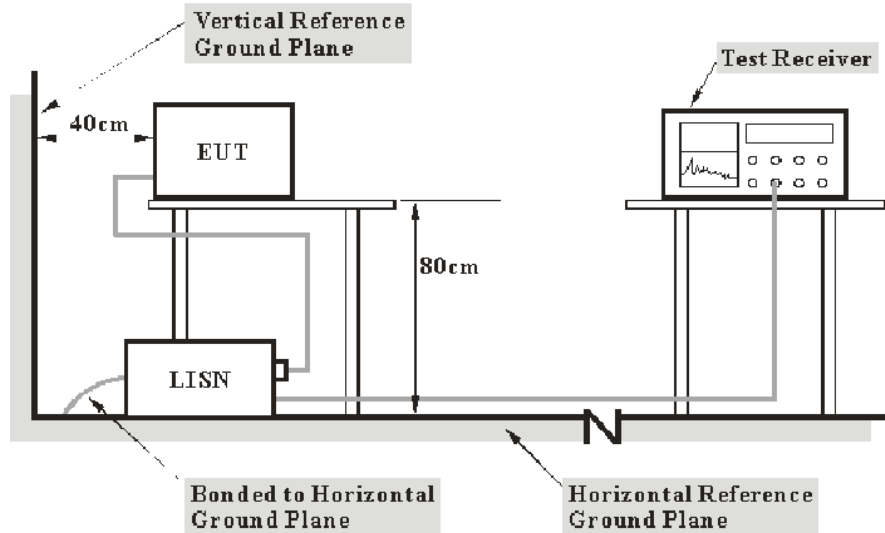

- Note: 1. Support units were connected to second LISN.
 2. Both of LISNs (AMN) 80 cm from EUT and at the least 80 cm from other units and other metal planes support units.

The setup of EUT is according with per ANSI C63.10-2013 measurement procedure. The specification used was with the FCC Part 15.207.

The spacing between the peripherals was 10 cm.

The adapter was connected to the main lisen with a 120 V/60 Hz AC power source.

EMI Test Receiver Setup

The EMI test receiver was set to investigate the spectrum from 150 kHz to 30 MHz.

During the conducted emission test, the EMI test receiver was set with the following configurations:

Frequency Range	IF B/W
150 kHz – 30 MHz	9 kHz

Test Procedure

During the conducted emission test, the adapter was connected to the first LISN.

The frequency and amplitude of the six highest ac power-line conducted emissions relative to the limit, measured over all the current-carrying conductors of the EUT power cords, and the operating frequency or frequency to which the EUT is tuned (if appropriate), should be reported, unless such emissions are more than 20 dB below the limit. AC power-line conducted emissions measurements are to be separately carried out only on each of the phase (“hot”) line(s) and (if used) on the neutral line(s), but not on the ground [protective earth] line(s). If less than six emission frequencies are within 20 dB of the limit, then the noise level of the measuring instrument at representative frequencies should be reported. The specific conductor of the power-line cord for each of the reported emissions should be identified. Measure the six highest emissions with respect to the limit on each current-carrying conductor of each power cord associated with the EUT (but not the power cords of associated or peripheral equipment that are part of the test configuration). Then, report the six highest emissions with respect to the limit from among all the measurements identifying the frequency and specific current-carrying conductor identified with the emission. The six highest emissions should be reported for each of the current-carrying conductors, or the six highest emissions may be reported over all the current-carrying conductors.

Corrected Amplitude & Margin Calculation

The basic equation is as follows:

$$V_C = V_R + A_C + VDF$$

$$C_f = A_C + VDF$$

Herein,

V_C (cord. Reading): corrected voltage amplitude

V_R : reading voltage amplitude

A_C : attenuation caused by cable loss

VDF: voltage division factor of AMN

C_f : Correction Factor

The “**Margin**” column of the following data tables indicates the degree of compliance within the applicable limit. For example, a margin of 7dB means the emission is 7dB below the limit. The equation for margin calculation is as follows:

$$\text{Margin} = \text{Limit} - \text{Corrected Amplitude}$$

Test Equipment List and Details

Manufacturer	Description	Model	Serial Number	Calibration Date	Calibration Due Date
R&S	LISN	ENV 216	101614	2020-09-12	2021-09-12
R&S	EMI Test Receiver	ESCI	101121	2020-07-07	2021-07-07
MICRO-COAX	Coaxial Cable	C-NJNJ-50	C-0200-01	2020-09-05	2021-09-05
R&S	Test Software	EMC32	Version 9.10.00	N/A	N/A

* **Statement of Traceability:** Bay Area Compliance Laboratories Corp. (Dongguan) attests that all calibrations have been performed, traceable to National Primary Standards and International System of Units (SI).

Test Data**Environmental Conditions**

Temperature:	21.7°C
Relative Humidity:	34%
ATM Pressure:	101.4kPa
Tester:	Walker Chen
Test Date:	2020-01-05

Test Result: Compliance

Test Mode: Transmitting

AC120 V, 60 Hz, Line:

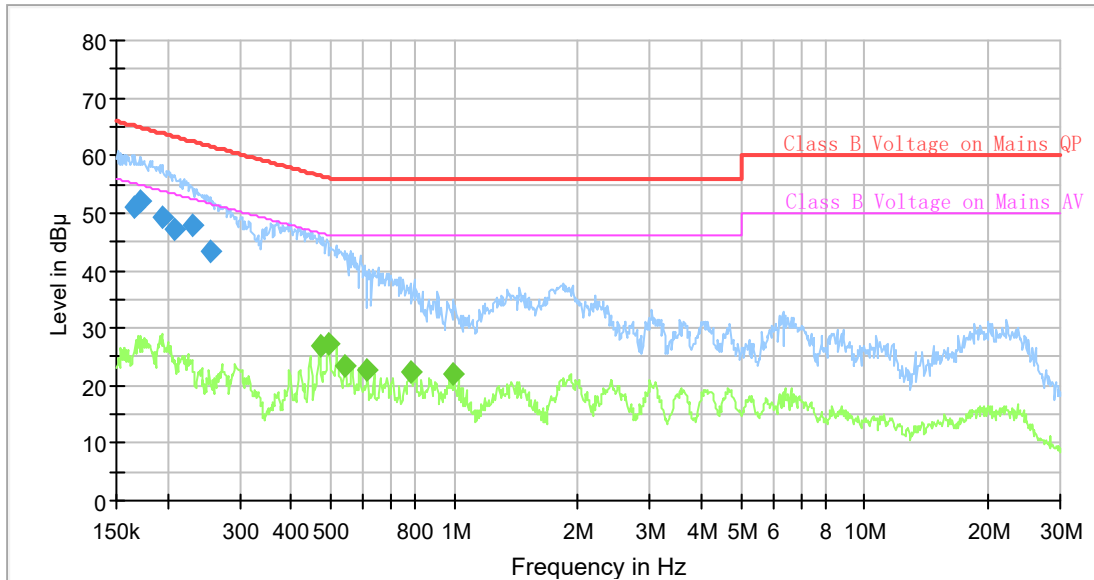

Final_Result

Frequency (MHz)	QuasiPeak (dB μ V)	Average (dB μ V)	Limit (dB μ V)	Margin (dB)	Bandwidth (kHz)	Line	Corr. (dB)
0.166563	51.11	---	65.13	14.02	9.000	L1	9.6
0.172481	51.96	---	64.84	12.88	9.000	L1	9.6
0.194414	49.20	---	63.85	14.65	9.000	L1	9.6
0.208474	47.15	---	63.27	16.12	9.000	L1	9.6
0.229196	47.78	---	62.48	14.70	9.000	L1	9.6
0.255776	43.29	---	61.57	18.28	9.000	L1	9.6
0.470023	---	27.06	46.51	19.45	9.000	L1	9.6
0.494060	---	27.37	46.10	18.73	9.000	L1	9.6
0.543169	---	23.55	46.00	22.45	9.000	L1	9.6
0.612239	---	22.80	46.00	23.20	9.000	L1	9.6
0.781732	---	22.35	46.00	23.65	9.000	L1	9.7
0.998148	---	21.92	46.00	24.08	9.000	L1	9.7

AC120 V, 60 Hz, Neutral:

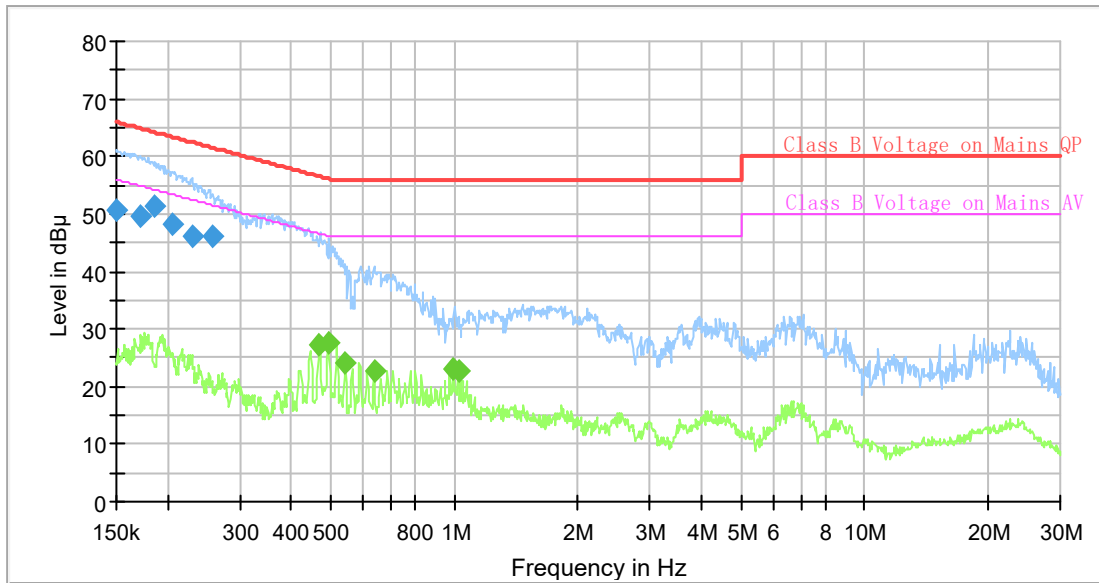

Final Result

Frequency (MHz)	QuasiPeak (dB µ V)	Average (dB µ V)	Limit (dB µ V)	Margin (dB)	Bandwidth (kHz)	Line	Corr. (dB)
0.150750	50.81	---	65.96	15.15	9.000	N	9.6
0.170769	49.56	---	64.92	15.36	9.000	N	9.6
0.185880	51.25	---	64.22	12.97	9.000	N	9.6
0.206405	48.16	---	63.35	15.19	9.000	N	9.6
0.229196	45.95	---	62.48	16.53	9.000	N	9.6
0.258340	46.23	---	61.48	15.25	9.000	N	9.6
0.467685	---	27.42	46.55	19.13	9.000	N	9.6
0.494060	---	27.77	46.10	18.33	9.000	N	9.6
0.540467	---	24.01	46.00	21.99	9.000	N	9.6
0.637161	---	22.65	46.00	23.35	9.000	N	9.6
0.998148	---	23.04	46.00	22.96	9.000	N	9.6
1.023352	---	22.87	46.00	23.13	9.000	N	9.6

FCC §15.209, §15.205, §15.247(d) - Spurious Emissions

Applicable Standard

FCC §15.247 (d); §15.209; §15.205

EUT Setup

Below 1GHz:

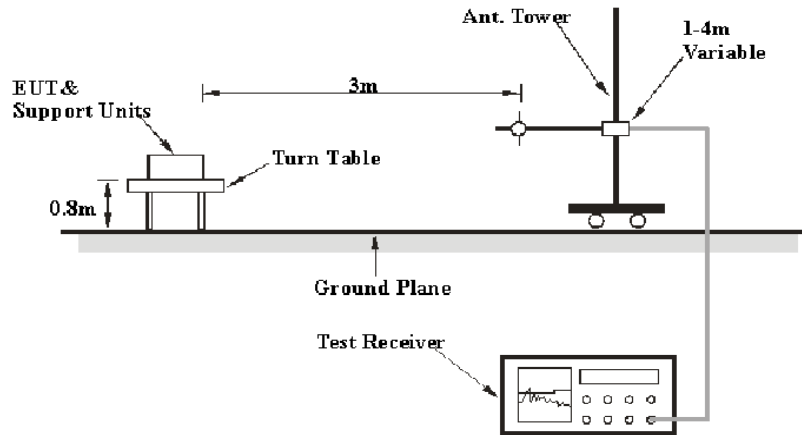

Above 1GHz:

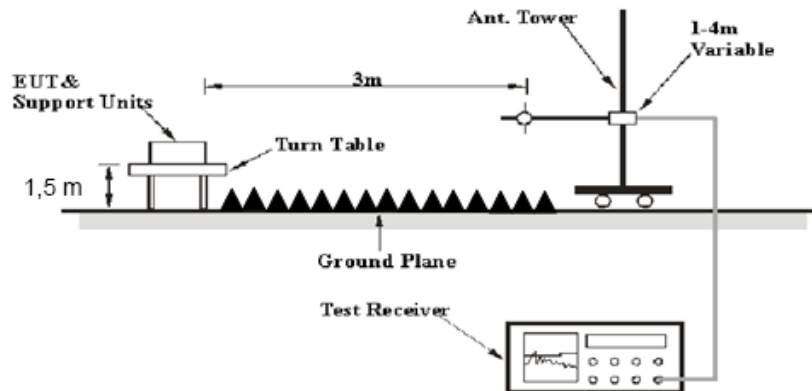

The radiated emission below 1GHz tests were performed in the 3 meters chamber A, above 1GHz tests were performed in the 3 meters chamber A, using the setup accordance with the ANSI C63.10-2013. The specification used was the FCC 15.209, and FCC 15.247 limits.

The external I/O cables were draped along the test table and formed a bundle 30 to 40 cm long in the middle.

The spacing between the peripherals was 10 cm.

EMI Test Receiver & Spectrum Analyzer Setup

The system was investigated from 30 MHz to 25 GHz.

During the radiated emission test, the EMI test receiver & Spectrum Analyzer Setup were set with the following configurations:

30MHz-1000MHz:

Measurement	RBW	Video B/W	IF B/W
QP	120 kHz	300 kHz	120kHz

1GHz- 25GHz:

Measurement	Duty cycle	RBW	Video B/W
PK	Any	1MHz	3 MHz
AV	>98%	1MHz	10 Hz
	<98%	1MHz	1/T

Note: T is minimum transmission duration

If the maximized peak measured value complies with under the QP/Average limit more than 6dB, then it is unnecessary to perform an QP/Average measurement.

Test Procedure

Maximizing procedure was performed on the highest emissions to ensure that the EUT complied with all installation combinations.

Data was recorded in Quasi-peak detection mode for frequency range of 30 MHz-1 GHz, peak and Average detection modes for frequencies above 1 GHz.

Corrected Amplitude & Margin Calculation

The Corrected Amplitude is calculated by adding the Antenna Factor and Cable Loss, and subtracting the Amplifier Gain from the Meter Reading. The basic equation is as follows:

$$\text{Corrected Amplitude} = \text{Meter Reading} + \text{Antenna Factor} + \text{Cable Loss} - \text{Amplifier Gain}$$

The “**Margin**” column of the following data tables indicates the degree of compliance with the applicable limit. For example, a margin of 7dB means the emission is 7dB below the limit. The equation for margin calculation is as follows:

$$\text{Margin} = \text{Limit} - \text{Corrected Amplitude}$$

Test Equipment List and Details

Manufacturer	Description	Model	Serial Number	Calibration Date	Calibration Due Date
Radiation Below 1GHz					
Sunol Sciences	Antenna	JB3	A060611-2	2020-08-25	2023-08-25
R&S	EMI Test Receiver	ESCI	100224	2020-09-12	2021-09-12
Unknown	Coaxial Cable	C-NJNJ-50	C-1000-01	2020-09-05	2021-09-05
Unknown	Coaxial Cable	C-NJNJ-50	C-0400-02	2020-09-05	2021-09-05
Unknown	Coaxial Cable	C-NJNJ-50	C-0530-01	2020-09-24	2021-09-24
Sonoma	Amplifier	310N	185914	2020-10-13	2021-10-13
Farad	Test Software	EZ-EMC	V1.1.4.2	N/A	N/A
Radiation Above 1GHz					
TDK RF	Horn Antenna	HRN-0118	130 084	2018-10-12	2021-10-12
Ducommun Technologies	Horn Antenna	ARH-4223-02	1007726-01 1304	2020-12-06	2023-12-05
R&S	Spectrum Analyzer	FSP 38	100478	2020-07-07	2021-07-07
HUBER+SUHNER	Coaxial Cable	SUCOFLEX 126EA	MY369/26/26E A	2020-09-25	2021-09-25
Mini	Pre-amplifier	ZVA-183-S+	5969001149	2020-09-05	2021-09-05
Quinstar	Amplifier	QLW-18405536-JO	15964001001	2020-06-27	2021-06-27
Farad	Test Software	EZ-EMC	V1.1.4.2	N/A	N/A
E-Microwave	Band-stop Filters	OBSF-2400-2483.5-S	OE01601525	2020-06-16	2021-06-16
Micro-tronics	High Pass Filter	HPM50111	S/N-G217	2020-06-16	2021-06-16

* **Statement of Traceability:** Bay Area Compliance Laboratories Corp. (Dongguan) attests that all calibrations have been performed, traceable to National Primary Standards and International System of Units (SI).

Test Data

Environmental Conditions

Test Items	Radiation Below 1GHz	Radiation Above 1GHz
Temperature:	22.2°C	19.5°C
Relative Humidity:	48%	31%
ATM Pressure:	101.4kPa	102kPa
Tester:	Jalon Liu	Jalon Liu
Test Date:	2020-12-24	2020-12-21

Test Mode: Transmitting

Test Result: Compliance. Please refer to the following table and plots.

1) 30MHz-1GHz (Low Channel was the worst):

Horizontal:

80.0 dB μ V/m

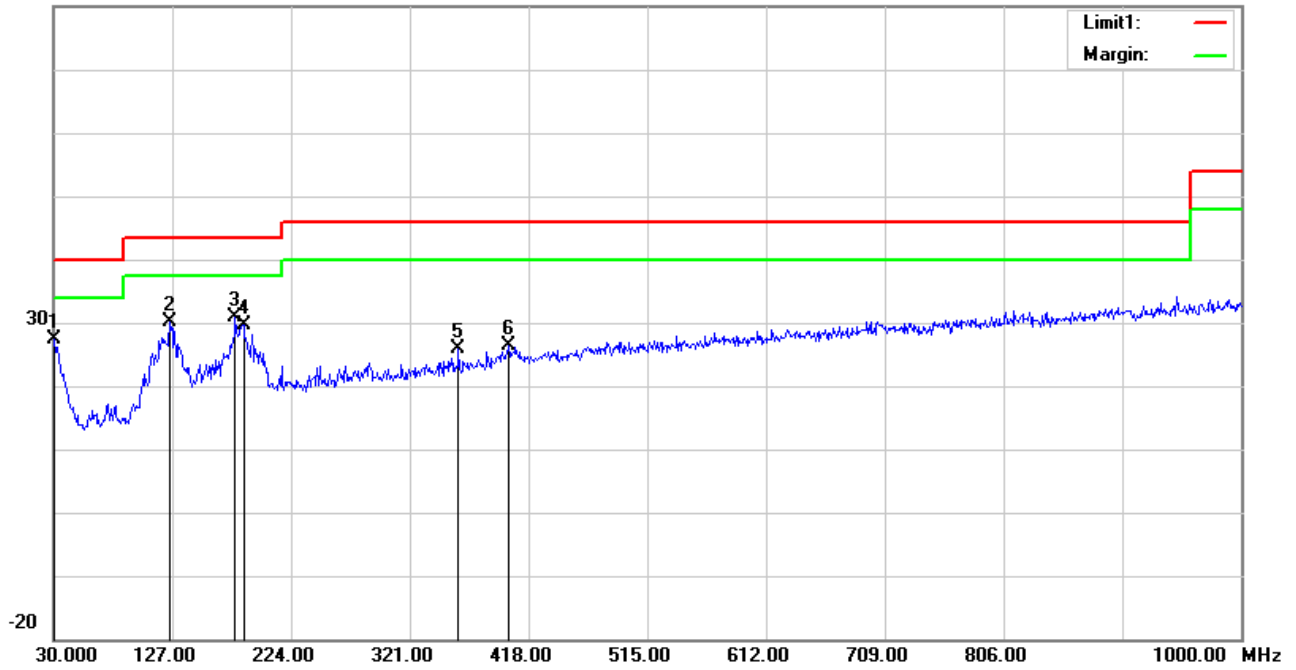

No.	Frequency (MHz)	Reading (dB μ V)	Detector	Corrected (dB/m)	Result (dB μ V/m)	Limit (dB μ V/m)	Margin (dB)
1	30.9700	26.66	peak	0.74	27.40	40.00	12.60
2	125.0600	34.86	peak	-4.81	30.05	43.50	13.45
3	178.4100	37.76	peak	-7.00	30.76	43.50	12.74
4	185.2000	36.77	peak	-7.17	29.60	43.50	13.90
5	360.7700	28.57	peak	-2.76	25.81	46.00	20.19
6	401.5100	28.57	peak	-2.09	26.48	46.00	19.52

Vertical:

80.0 dB μ V/m

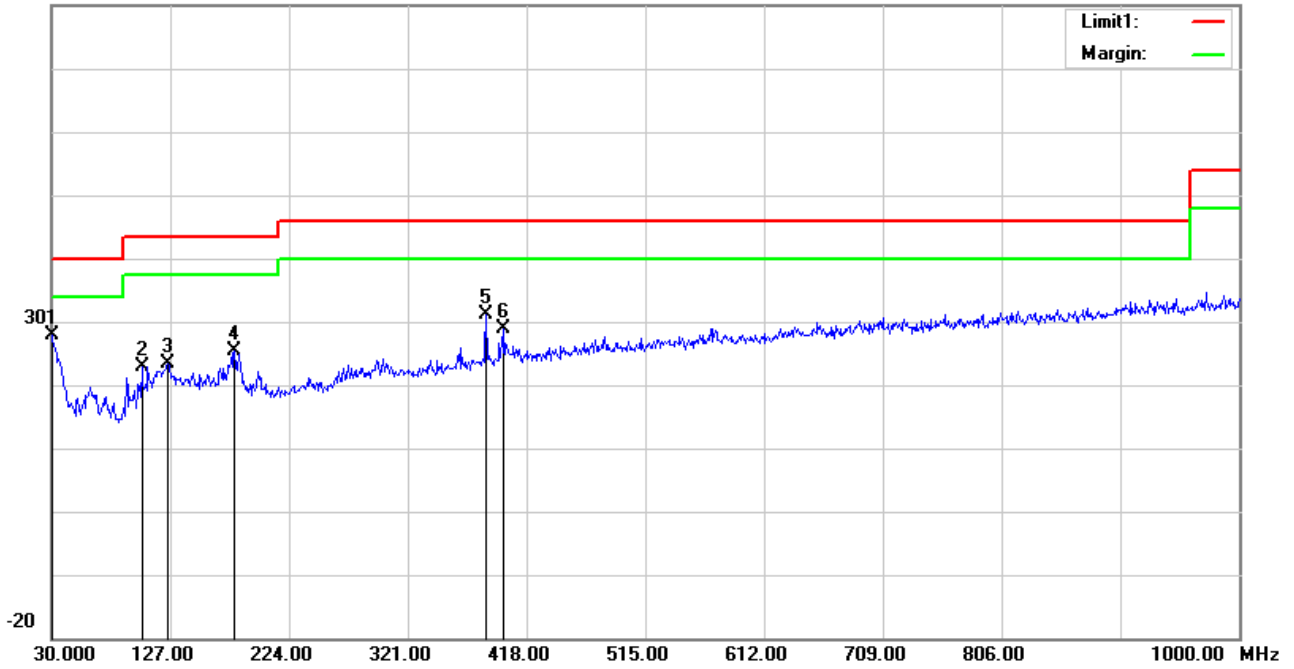

No.	Frequency (MHz)	Reading (dB μ V)	Detector	Corrected (dB/m)	Result (dB μ V/m)	Limit (dB μ V/m)	Margin (dB)
1	30.0000	26.33	peak	1.46	27.79	40.00	12.21
2	103.7200	30.87	peak	-8.03	22.84	43.50	20.66
3	125.0600	28.31	peak	-4.81	23.50	43.50	20.00
4	179.3800	32.41	peak	-6.94	25.47	43.50	18.03
5	385.0200	33.48	peak	-2.44	31.04	46.00	14.96
6	399.5700	30.95	peak	-2.11	28.84	46.00	17.16

2)1GHz-25GHz:

Frequency (MHz)	Receiver		Rx Antenna		Cable loss (dB)	Amplifier Gain (dB)	Corrected Amplitude (dB μ V/m)	Limit (dB μ V/m)	Margin (dB)
	Reading (dB μ V)	Remark	Polar (H/V)	Factor (dB/m)					
Low Channel: 2402 MHz									
2390.00	28.89	PK	H	24.80	2.50	0.00	56.19	74.00	17.81
2390.00	17.53	AV	H	24.80	2.50	0.00	44.83	54.00	9.17
4804.00	48.87	PK	H	29.71	3.59	27.36	54.81	74.00	19.19
4804.00	45.42	AV	H	29.71	3.59	27.36	51.36	54.00	2.64
7206.00	37.99	PK	H	33.93	4.68	27.19	49.41	74.00	24.59
7206.00	30.01	AV	H	33.93	4.68	27.19	41.43	54.00	12.57
Middle Channel: 2440 MHz									
4880.00	45.61	PK	H	29.86	3.58	27.55	51.50	74.00	22.50
4880.00	40.34	AV	H	29.86	3.58	27.55	46.23	54.00	7.77
7320.00	38.63	PK	H	34.11	4.64	27.26	50.12	74.00	23.88
7320.00	30.56	AV	H	34.11	4.64	27.26	42.05	54.00	11.95
High Channel: 2480 MHz									
2483.50	29.56	PK	H	24.97	2.53	0.00	57.06	74.00	16.94
2483.50	18.62	AV	H	24.97	2.53	0.00	46.12	54.00	7.88
4960.00	46.23	PK	H	30.02	3.59	27.37	52.47	74.00	21.53
4960.00	41.73	AV	H	30.02	3.59	27.37	47.97	54.00	6.03
7440.00	39.21	PK	H	34.30	4.61	27.22	50.90	74.00	23.10
7440.00	31.15	AV	H	34.30	4.61	27.22	42.84	54.00	11.16

Worst plots (Low channel was the worst)

Horizontal

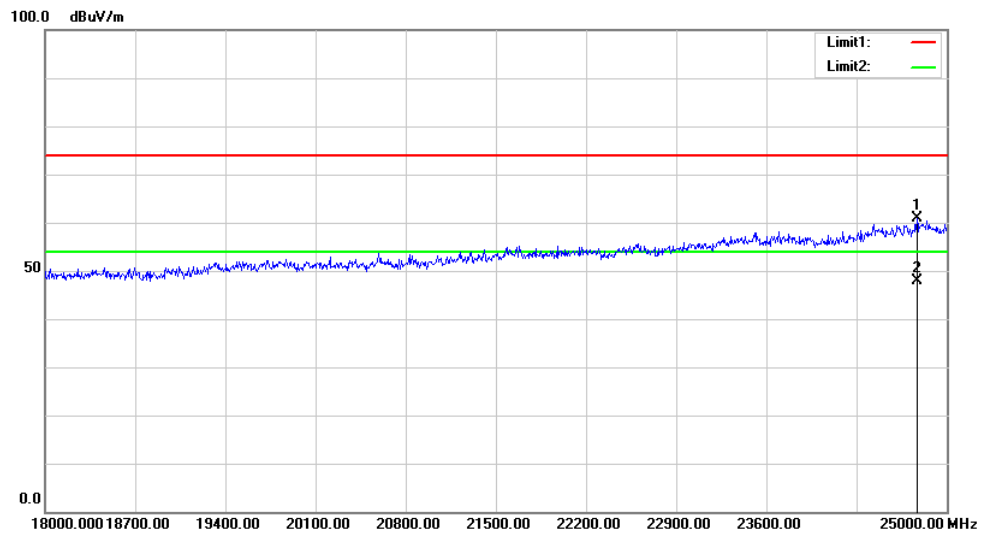
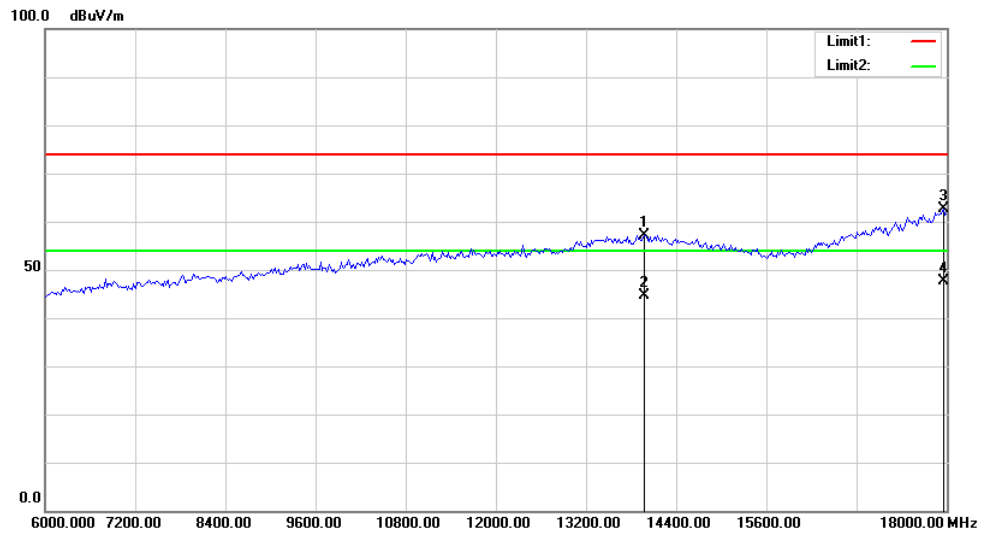
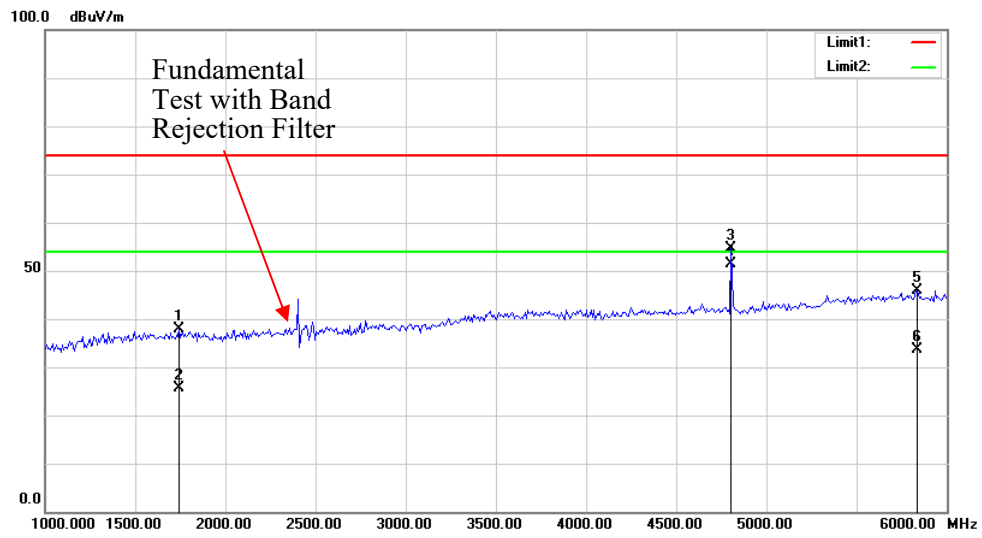

Vertical:

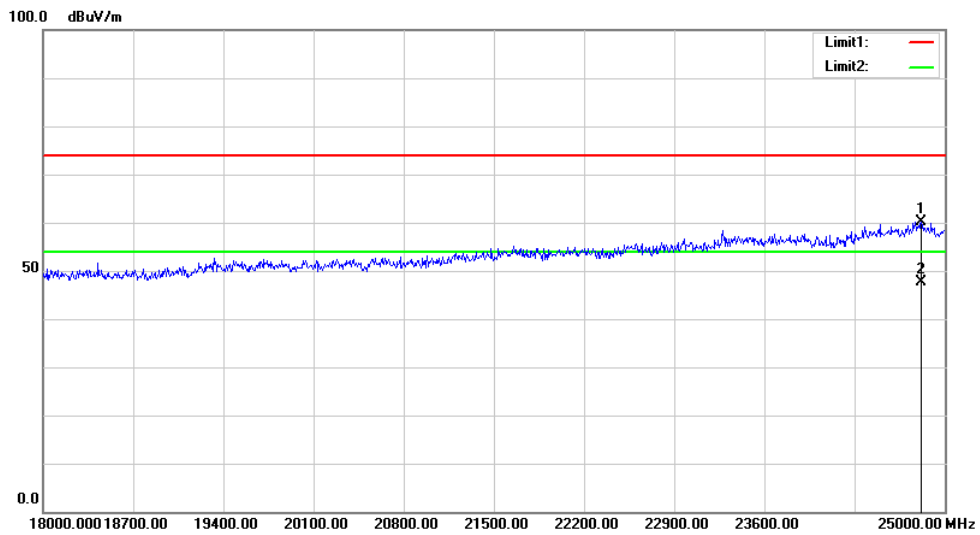
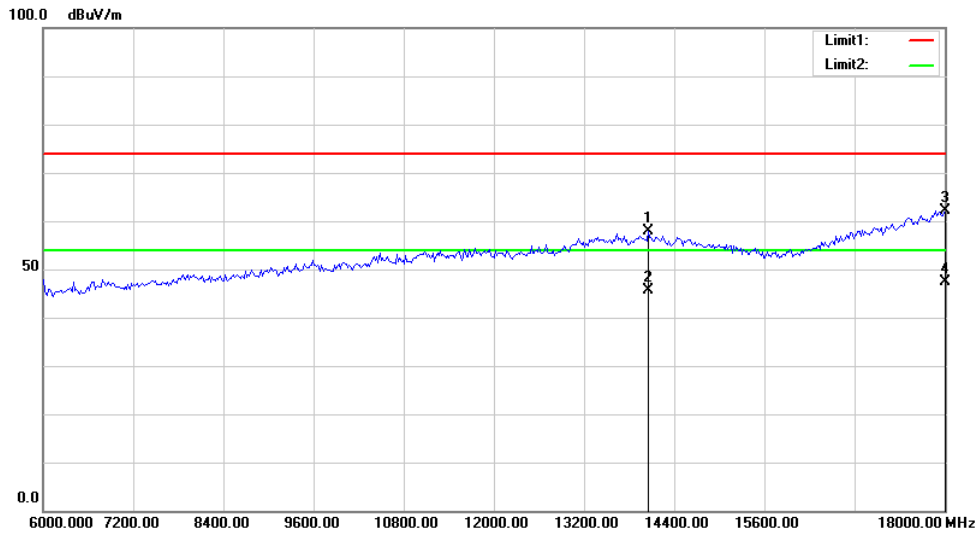
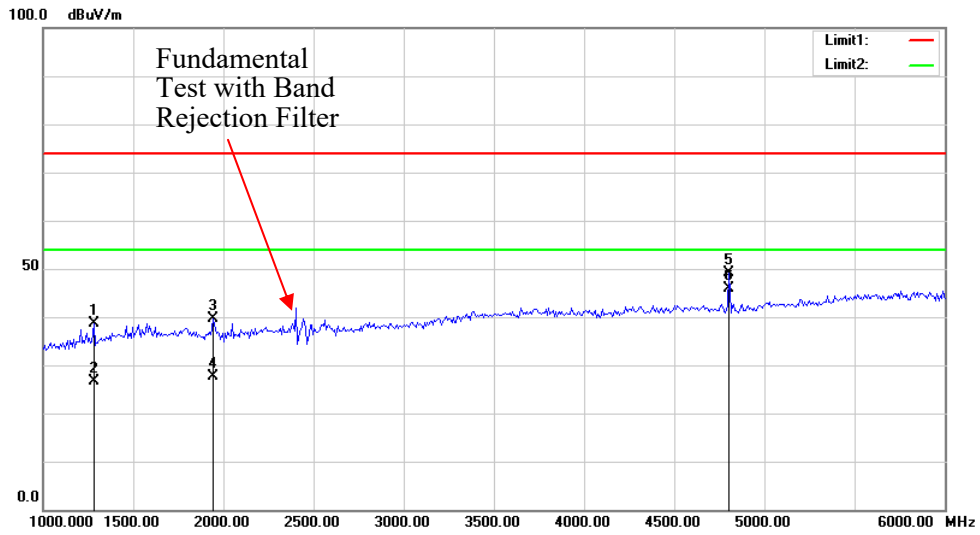

FCC §15.247(a) (2) –6 dB EMISSION BANDWIDTH

Applicable Standard

According to FCC §15.247(a) (2)

Systems using digital modulation techniques may operate in the 902–928 MHz, 2400–2483.5 MHz, and 5725–5850 MHz bands. The minimum 6 dB bandwidth shall be at least 500 kHz.

Test Procedure

- a) Set RBW = 100 kHz.
- b) Set the video bandwidth (VBW) $\geq 3 \times$ RBW.
- c) Detector = Peak.
- d) Trace mode = max hold.
- e) Sweep = auto couple.
- f) Allow the trace to stabilize.
- g) Measure the maximum width of the emission that is constrained by the frequencies associated with the two outermost amplitude points (upper and lower frequencies) that are attenuated by 6 dB relative to the maximum level measured in the fundamental emission.

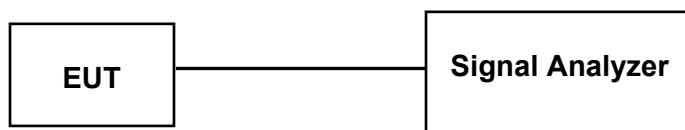

Test Equipment List and Details

Manufacturer	Description	Model	Serial Number	Calibration Date	Calibration Due Date
R&S	Spectrum Analyzer	FSV40	101474	2020-07-07	2021-07-07
yzjingcheng	Coaxial Cable	KTRFBU-141-50	41005012	Each time	N/A

* **Statement of Traceability:** Bay Area Compliance Laboratories Corp. (Dongguan) attests that all calibrations have been performed, traceable to National Primary Standards and International System of Units (SI).

Test Data

Environmental Conditions

Temperature:	22.3 °C
Relative Humidity:	43 %
ATM Pressure:	101.8 kPa
Tester:	Rennes Guo
Test Date:	2020-12-17

Test Mode: Transmitting

Test Result: Compliance. Please refer to the following table and plots.

Channel	Frequency (MHz)	Result (MHz)	Limit (MHz)
Low	2402	0.664	0.5
Middle	2440	0.664	
High	2480	0.664	

Low Channel

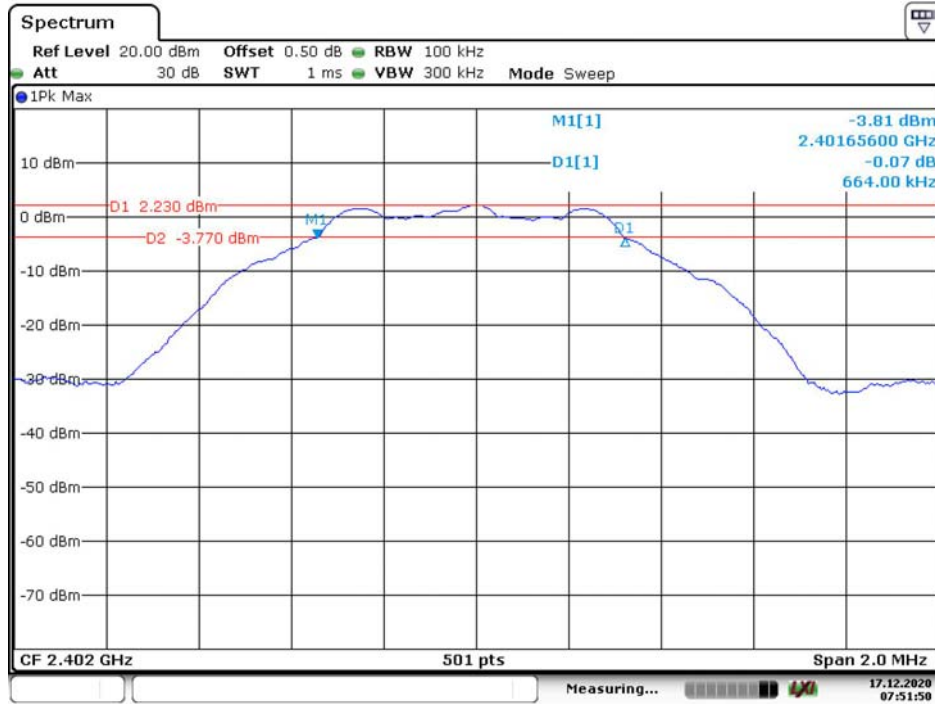

Date: 17.DEC.2020 07:51:51

Middle Channel

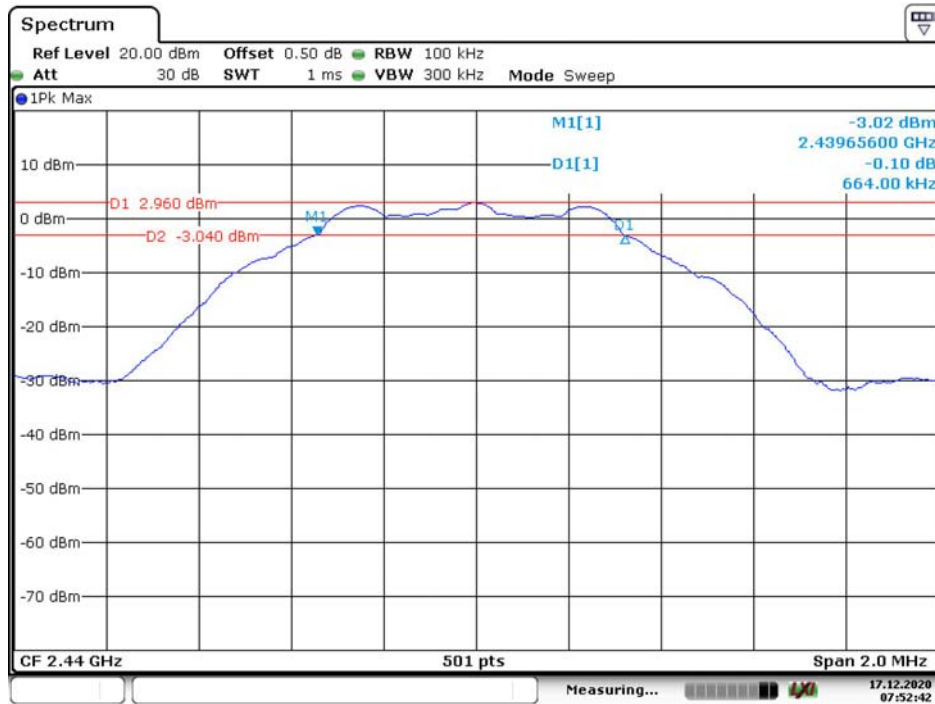

Date: 17.DEC.2020 07:52:43

High Channel

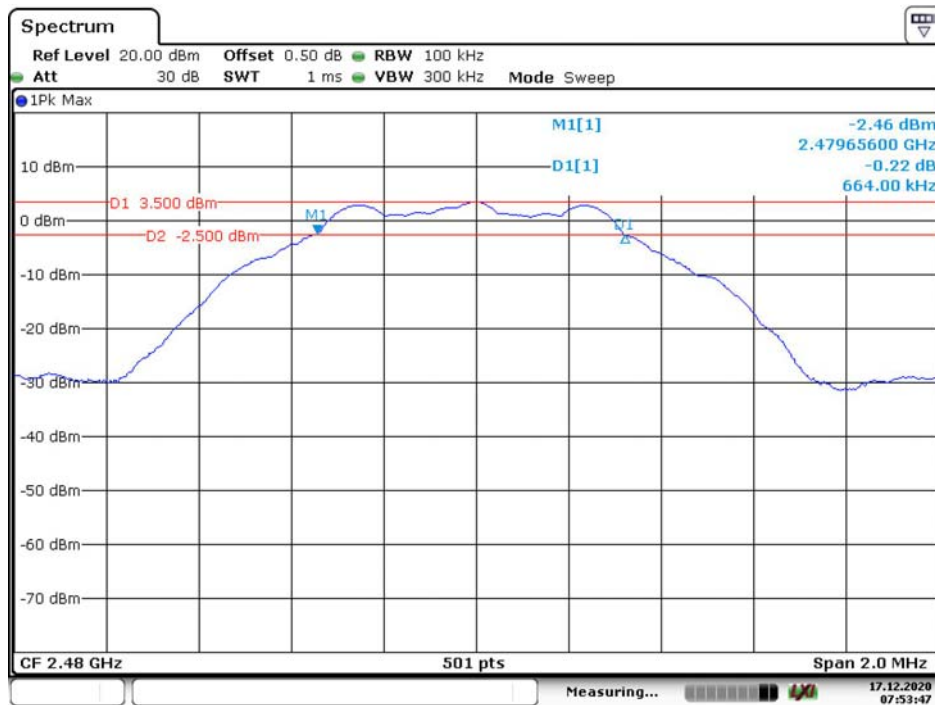

Date: 17.DEC.2020 07:53:47

FCC §15.247(b) (3) - Maximum Peak Conducted Output Power

Applicable Standard

According to FCC §15.247(b) (3), for systems using digital modulation in the 902-928 MHz, 2400-2483.5 MHz, and 5725-5850 MHz bands: 1 Watt. As an alternative to a peak power measurement, compliance with the one Watt limit can be based on a measurement of the maximum conducted output power.

Maximum Conducted Output Power is defined as the total transmit power delivered to all antennas and antenna elements averaged across all symbols in the signaling alphabet when the transmitter is operating at its maximum power control level. Power must be summed across all antennas and antenna elements. The average must not include any time intervals during which the transmitter is off or is transmitting at a reduced power level. If multiple modes of operation are possible (e.g., alternative modulation methods), the maximum conducted output power is the highest total transmit power occurring in any mode.

Test Procedure

1. Place the EUT on a bench and set it in transmitting mode.
2. Remove the antenna from the EUT and then connect a low loss RF cable from the antenna port to test equipment.
3. Add a correction factor to the display.

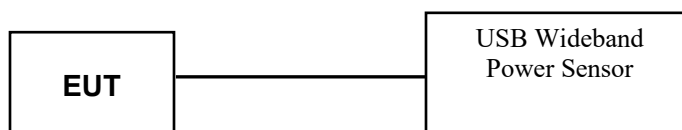

Test Equipment List and Details

Manufacturer	Description	Model	Serial Number	Calibration Date	Calibration Due Date
Agilent	USB Wideband Power Sensor	U2021XA	MY54080014	2020-09-12	2021-09-12
yzjingcheng	Coaxial Cable	KTRFBU-141-50	41005012	Each time	N/A

* **Statement of Traceability:** Bay Area Compliance Laboratories Corp. (Dongguan) attests that all calibrations have been performed, traceable to National Primary Standards and International System of Units (SI).

Test Data

Environmental Conditions

Temperature:	22.3 °C
Relative Humidity:	43 %
ATM Pressure:	101.8 kPa
Tester:	Rennes Guo
Test Date:	2020-12-17

Test Result: Compliance. Please refer to the following table.

Test Mode: Transmitting

Channel	Frequency (MHz)	Maximum Conducted Peak Output Power (dBm)	Limit (dBm)
Low	2402	2.95	30
Middle	2440	3.64	
High	2480	4.15	

FCC §15.247(d) – 100 kHz Bandwidth of Frequency Band Edge

Applicable Standard

According to FCC §15.247(d): In any 100 kHz bandwidth outside the frequency band in which the spread spectrum or digitally modulated intentional radiator is operating, the radio frequency power that is produced by the intentional radiator shall be at least 20 dB below that in the 100 kHz bandwidth within the band that contains the highest level of the desired power, based on either an RF conducted or a radiated measurement, provided the transmitter demonstrates compliance with the peak conducted power limits. If the transmitter complies with the conducted power limits based on the use of RMS averaging over a time interval, as permitted under paragraph (b)(3) of this section, the attenuation required under this paragraph shall be 30 dB instead of 20 dB. Attenuation below the general limits specified in §15.209(a) is not required. In addition, radiated emissions which fall in the restricted bands, as defined in §15.205(a), must also comply with the radiated emission limits specified in §15.209(a) (see §15.205(c)).

Test Procedure

1. Check the calibration of the measuring instrument using either an internal calibrator or a known signal from an external generator.
2. Position the EUT without connection to measurement instrument. Turn on the EUT and connect its antenna terminal to measurement instrument via a low loss cable. Then set it to any one measured frequency within its operating range, and make sure the instrument is operated in its linear range.
3. Set RBW to 100 kHz and VBW of spectrum analyzer to 300 kHz with a convenient frequency span including 100 kHz bandwidth from band edge.
4. Measure the highest amplitude appearing on spectral display and set it as a reference level. Plot the graph with marking the highest point and edge frequency.
5. Repeat above procedures until all measured frequencies were complete.

Test Equipment List and Details

Manufacturer	Description	Model	Serial Number	Calibration Date	Calibration Due Date
R&S	Spectrum Analyzer	FSV40	101474	2020-07-07	2021-07-07
yzjingcheng	Coaxial Cable	KTRFBU-141-50	41005012	Each time	N/A

* **Statement of Traceability:** Bay Area Compliance Laboratories Corp. (Dongguan) attests that all calibrations have been performed, traceable to National Primary Standards and International System of Units (SI).

Test Data

Environmental Conditions

Temperature:	22.3 °C
Relative Humidity:	43 %
ATM Pressure:	101.8 kPa
Tester:	Rennes Guo
Test Date:	2020-12-17

Test Result: Compliance. Please refer to following plots.

Test mode: Transmitting

Band Edge, Low

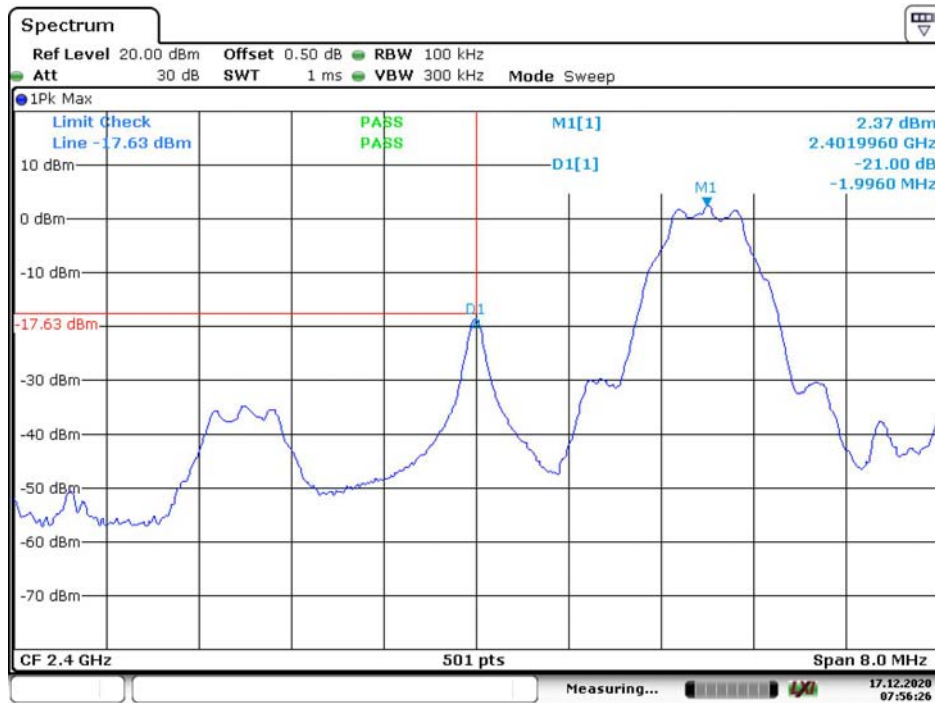

Band Edge, High

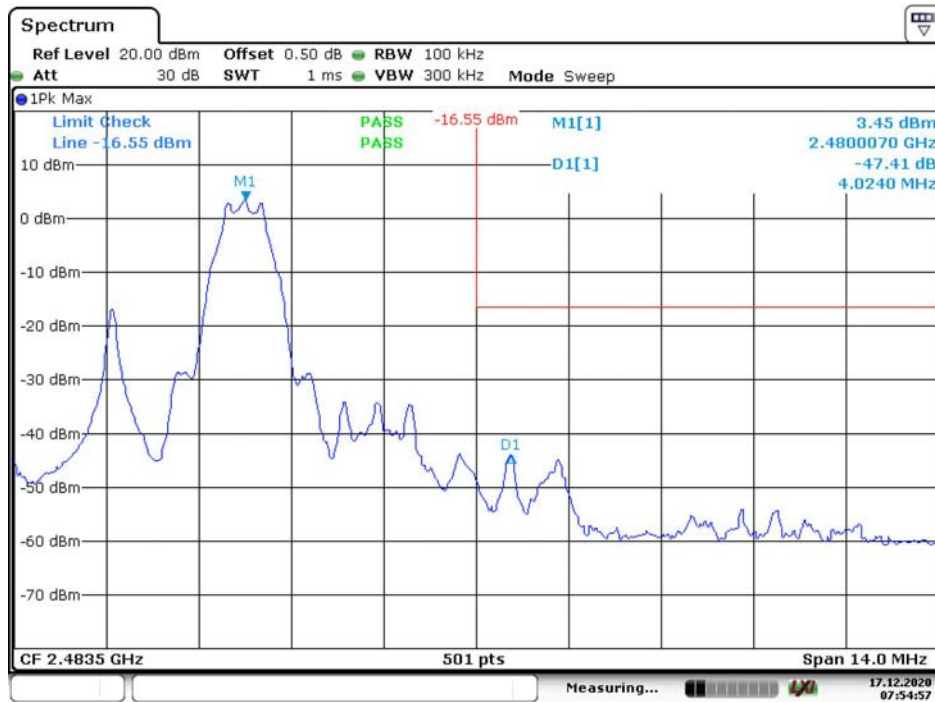

FCC §15.247(e) - Power Spectral Density

Applicable Standard

According to FCC§15.247(e):For digitally modulated systems, the power spectral density conducted from the intentional radiator to the antenna shall not be greater than 8 dBm in any 3 kHz band during any time interval of continuous transmission. This power spectral density shall be determined in accordance with the provisions of paragraph (b) of this section. The same method of determining the conducted output power shall be used to determine the power spectral density.

Test Procedure

1. Check the calibration of the measuring instrument using either an internal calibrator or a known signal from an external generator.
2. Position the EUT was set without connection to measurement instrument. Turn on the EUT and connect its antenna terminal to measurement instrument via a low loss cable. Then set it to any one measured frequency within its operating range, and make sure the instrument is operated in its linear range.
3. Set the RBW = 3 kHz, VBW = 10 kHz, Set the span to 1.5 times the DTS bandwidth.
4. Use the peak marker function to determine the maximum amplitude level.

Test Equipment List and Details

Manufacturer	Description	Model	Serial Number	Calibration Date	Calibration Due Date
R&S	Spectrum Analyzer	FSV40	101474	2020-07-07	2021-07-07
yzjingcheng	Coaxial Cable	KTRFBU-141-50	41005012	Each time	N/A

* **Statement of Traceability:** Bay Area Compliance Laboratories Corp. (Dongguan) attests that all calibrations have been performed, traceable to National Primary Standards and International System of Units (SI).

Test Data

Environmental Conditions

Temperature:	22.3 °C
Relative Humidity:	43 %
ATM Pressure:	101.8 kPa
Tester:	Rennes Guo
Test Date:	2020-12-17

Test Result: Compliance. Please refer to the following table and plots

Test Mode: Transmitting

Channel	Frequency (MHz)	Power Spectral Density (dBm/3kHz)	Limit (dBm/3kHz)
Low	2402	-15.10	8
Middle	2440	-14.35	
High	2480	-13.85	

Power Spectral Density, Low Channel

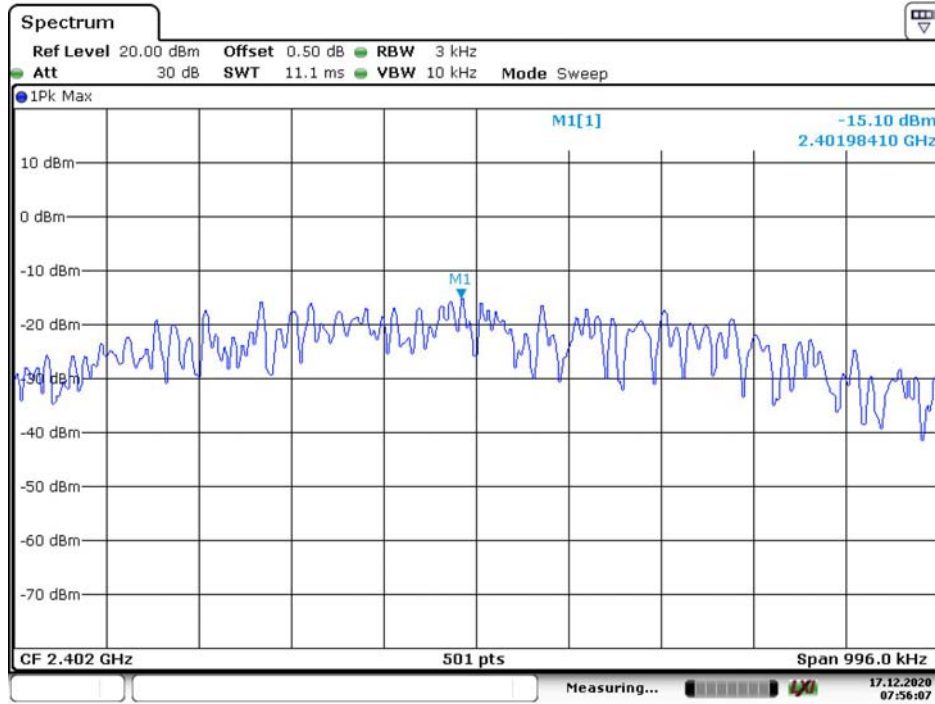

Date: 17.DEC.2020 07:56:08

Power Spectral Density, Middle Channel

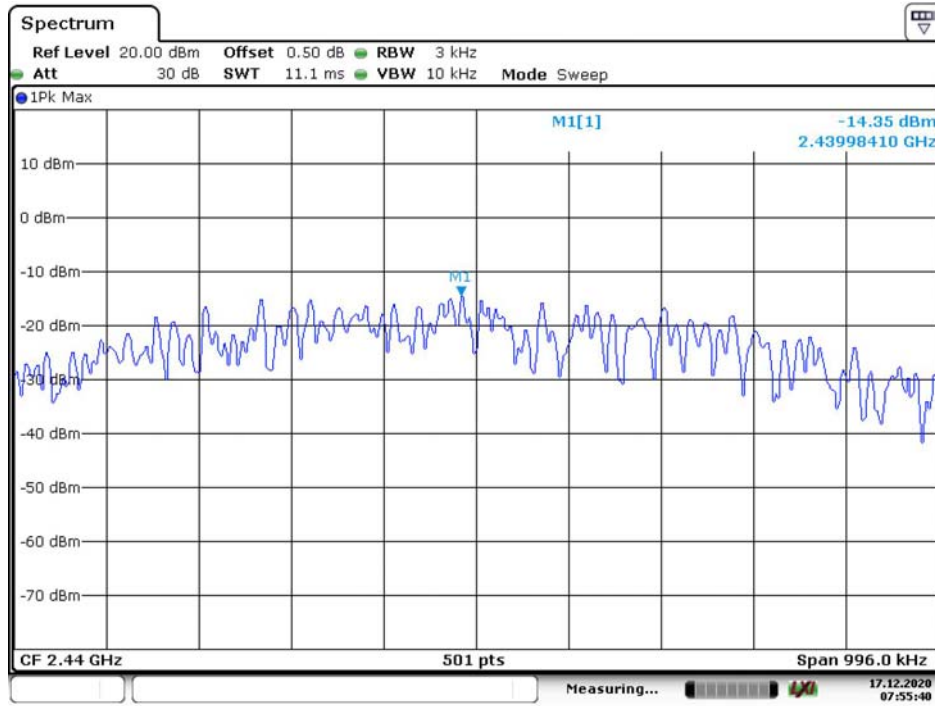

Date: 17.DEC.2020 07:55:41

Power Spectral Density, High Channel

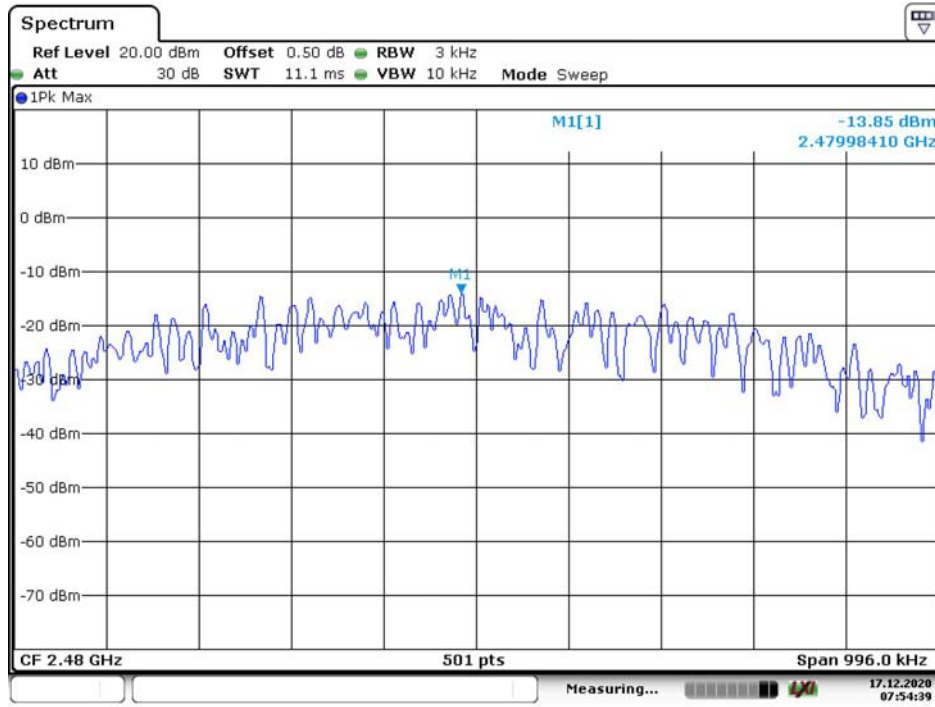

Date: 17.DEC.2020 07:54:40

***** END OF REPORT ****