



TEST REPORT

Test Report No. : UL-RPT-RP-12783492-1116-FCC

Applicant : Disruptive Technologies Research AS
Model No. : Sensor US
FCC ID : 2ATFX-100541
Technology : 902 – 928 MHz
Test Standard(s) : FCC Parts 15.209(a) & 15.249

For details of applied tests refer to test result summary

1. This test report shall not be reproduced in full or partial, without the written approval of UL International Germany GmbH.
2. The results in this report apply only to the sample tested.
3. The test results in this report are traceable to the national or international Boosts.
4. Test Report Version 1.0
5. Result of the tested sample: **PASS**

Prepared by: Krume Ivanov
Title: Laboratory Engineer
Date: 09 December 2019

Approved by: Ajit Phadtare
Title: Lead Test Engineer
Date: 09 December 2019



Deutsche
Akkreditierungsstelle
D-PL-19381-02-00

This laboratory is accredited by DAkkS.
The tests reported herein have been performed in
accordance with its' terms of accreditation.

This page has been left intentionally blank.

Table of Contents

1. Customer Information.....	4
1.1.Applicant Information	4
1.2.Manufacturer Information	4
2. Summary of Testing.....	5
2.1. General Information	5
Applied Boosts	5
Location	5
Date information	5
2.2. Summary of Test Results	6
2.3. Methods and Procedures	6
2.4. Deviations from the Test Specification	6
3. Equipment Under Test (EUT)	7
3.1. Identification of Equipment Under Test (EUT)	7
3.2. Description of EUT	7
3.3. Modifications Incorporated in the EUT	7
3.4. Additional Information Related to Testing	8
3.5. Support Equipment	9
A. Support Equipment (In-house)	9
B. Support Equipment (Manufacturer supplied)	9
4. Operation and Monitoring of the EUT during Testing	10
4.1. Operating Modes	10
4.2. Configuration and Peripherals	10
5. Measurements, Examinations and Derived Results.....	11
5.1. General Comments	11
5.2. Test Results	12
5.2.1. Transmitter 20 dB Bandwidth	12
5.2.2. Transmitter Duty Cycle	15
5.2.3. Transmitter Fundamental Field Strength	19
5.2.4. Transmitter Radiated Emissions	23
5.2.5. Transmitter Band Edge Radiated Emissions	37
6. Measurement Uncertainty	40
7. Used equipment.....	41
8. Report Revision History	42

1. Customer Information

1.1.Applicant Information

Company Name:	Disruptive Technologies Research AS
Company Address:	Ytrebygdsveien 215, 5258 Blomsterdalen, Bergen, Norway
Contact Person:	Bengt Johannes Lundberg
Contact E-Mail:	bengt.lundberg@disruptive-technologies.com
Contact Phone No.:	+47 91633887

1.2.Manufacturer Information

Company Name:	Zollner Elektronik AG
Company Address:	Manfred-Zollner-Straße 1, 93499 Zandt, Germany
Contact Person:	Thomas Glasschröder (QA Manager)
Contact E-Mail:	thomas_glasschroeder@zollner.de
Contact Phone No.:	+49 9944-201-7146

2. Summary of Testing

2.1. General Information

Applied Boosts

Specification Reference:	47CFR15.249
Specification Title:	Code of Federal Regulations Volume 47 (Telecommunications): Part 15 Subpart C (Intentional Radiators) - Section 15.249
Specification Reference:	47CFR15.207 and 47CFR15.209
Specification Title:	Code of Federal Regulations Volume 47 (Telecommunications): Part 15 Subpart C (Intentional Radiators) - Sections 15.207 and 15.209
Test Firm Registration:	399704

Location

Location of Testing:	UL International Germany GmbH Hedelfinger Str. 61 70327 Stuttgart Germany
-----------------------------	--

Date information

Order Date:	22 March 2019
EUT arrived:	02 September 2019
Test Dates:	02 September 2019 to 05 December 2019
EUT returned:	-/-

2.2. Summary of Test Results

Clause	Measurement	Complied	Did not comply	Not performed	Not applicable
Part 15.207	Transmitter AC Conducted Emissions ⁽¹⁾	<input type="checkbox"/>	<input type="checkbox"/>	<input type="checkbox"/>	<input checked="" type="checkbox"/>
Part 2.1049	Transmitter 20 dB Bandwidth	<input checked="" type="checkbox"/>	<input type="checkbox"/>	<input type="checkbox"/>	<input type="checkbox"/>
Part 15.35(c)	Transmitter Duty Cycle	<input checked="" type="checkbox"/>	<input type="checkbox"/>	<input type="checkbox"/>	<input type="checkbox"/>
Part 15.249(a)	Transmitter Fundamental Field Strength	<input checked="" type="checkbox"/>	<input type="checkbox"/>	<input type="checkbox"/>	<input type="checkbox"/>
Part 15.249(a)(d)(e)/ 15.209(a)	Transmitter Radiated Emissions	<input checked="" type="checkbox"/>	<input type="checkbox"/>	<input type="checkbox"/>	<input type="checkbox"/>
Part 15.249(d) & 15.209(a)	Transmitter Band Edge Radiated Emissions	<input checked="" type="checkbox"/>	<input type="checkbox"/>	<input type="checkbox"/>	<input type="checkbox"/>

Note:

1. Not Applicable as EUT operates using a non rechargeable battery power.

2.3. Methods and Procedures

Reference:	ANSI C63.10-2013
Title:	American National Standard of Procedures for Compliance Testing of Unlicensed Wireless Devices
Reference:	KDB 414788 D01 Radiated Test Site v01r01, July 12, 2018
Title:	TEST SITES FOR RADIATED EMISSION MEASUREMENTS

2.4. Deviations from the Test Specification

For the measurements contained within this test report, there were no deviations from, additions to, or exclusions from the test specification identified above.

3. Equipment Under Test (EUT)

3.1. Identification of Equipment Under Test (EUT)

Brand Name:	Disruptive Technologies
Model Name or Number:	Sensor US
Test Sample Serial Number:	U3,U4,U7,U8,U9,U10 (Radiated samples)
Hardware Version Number:	100541-1.2
Software Version Number:	cc13xx_firmware/1.2.28
Firmware Version Number:	101652
FCC ID:	2ATFX-100541

Brand Name:	Disruptive Technologies
Model Name or Number:	Sensor US
Test Sample Serial Number:	T1 (Conducted samples with RF port)
Hardware Version Number:	100541-1.2
Software Version Number:	cc13xx_firmware/1.2.28
Firmware Version Number:	101652
FCC ID:	2ATFX-100541

3.2. Description of EUT

The equipment under test was a Wireless IoT Sensor powered via a non rechargeable battery; operating on 902-928 MHz communications through a Cloud Connector gateway.

3.3. Modifications Incorporated in the EUT

No modifications were applied to the EUT during testing.

3.4. Additional Information Related to Testing

Tested Technology:	902-928 MHz (Boost Mode)	
Power Supply Requirement:	Nominal	3 V DC (Internal battery)
Type of Unit:	Transceiver	
Channel Spacing:	Fixed frequency	
Modulation:	Frequency Shift Keying (FSK)	
Data Rate (kbps):	240	
Transmitter Fundamental Field Strength	78.71 dBµV/m	
Antenna Gain:	-27.0 dBi	
Antenna Type:	Integrated PCB Antenna	
Antenna Details :	Model No. PN 100132-1 "DT Sensor antenna, 1st segment" and PN 100134-1 "DT Sensor antenna, 3rd segment" Manufacturer: DISRUPTIVE TECHNOLOGIES	
Transmit Frequency Range:	902.775 MHz to 927.225 MHz	
Transmit Channels (Fixed Frequency) Tested:	Channel ID	Channel Frequency (MHz)
	Bottom	902.775
	Middle	915.000
	Top	927.225

3.5. Support Equipment

The following support equipment was used to exercise the EUT during testing:

A. Support Equipment (In-house)

Item	Description	Brand Name	Model Name or Number	Serial Number
1	RJ 45 Cable	Not stated	Not stated	Not stated

B. Support Equipment (Manufacturer supplied)

Item	Description	Brand Name	Model Name or Number	Serial Number
1	Ethernet switch with power-over-ethernet (PoE) Injector	D-Link	DPE-101GI	SQ031HB003386
2	Switching Power Supply (PoE)	mimosa	POE16R-560	502-00005
3	POE/LAN Cable 5 m (M12x Coded to RJ45)	Not stated	1407473	Not stated
4	Laptop computer	Apple	MacBook Pro	C02T60V0GY25
5	Gateway with an 902-928 MHz RF-Technology, that relays communication between sensors and the cloud	Disruptive Technologies Research AS	Cloud Connector US	bjemb9tuvn3g0008o500

4. Operation and Monitoring of the EUT during Testing

4.1. Operating Modes

The EUT was tested in the following operating mode(s):

- Transmitting Mode – Boost Mode Fixed Channel Frequency Mode

4.2. Configuration and Peripherals

The EUT was tested in the following configuration(s):

- **EUT Power Supply:**
 - For all conducted measurements the EUT was powered using lab DC power supply supplying 3.3 V DC to EUT.
 - For all radiated measurements the EUT was powered via the non-rechargeable internal battery.
- **Test Mode Activation:**
 - With help of customer supplied a Gateway “Cloud Connector US” supporting 902-928 MHz RF-Technology test modes were activated wirelessly.
 - This Gateway was powered via PoE injector & connected to the internet via a LAN cable.
 - A wireless connection was established between this Gateway & EUT.
 - The Test mode configuration files were installed on MacBook supplied by customer.
 - This Test mode configuration were activated using a test setup instructions “2019-07-24 Instructions for UL to operate CCONs.pdf” supplied by customer.
- **Conducted Measurements:**
 - 20 dB Bandwidth & Duty Cycles were measured with conducted sample.
 - The conducted sample was transmitting with 99.39% duty cycle therefore no duty cycle correction was required.
 - All Conducted measurements were carried out by using conducted sample with SMA (Female) RF Cable soldered on PCB by the customer. The RF cable’s attenuation (maximum 5.0 dB at the tested frequencies) of which 0.5 dB was already added to a reference level offset to each of the conducted plots & additional 4.5 dB attenuation has been corrected from plot values.
 - The RF port on the EUT was connected to the spectrum analyser using suitable attenuation and RF cable. The measured values takes into consideration the external attenuation correction factors. The RF cable attenuation (maximum 0.4 dB at the tested frequencies) from the EUT to Analyzer including the 10 dB attenuation at the Spectrum Analyzer input and 0.5 dB for the SMA RF-cable attenuation was added as a reference level offset (10.9 dB) to each of the conducted plots.
- **Radiated Measurements:**
 - The radiated samples were transmitting with 7.19% duty cycle therefore duty cycle correction are required for average measurements.
 - Before starting final radiated measurements “worst case verification” with the EUT in Standing-position & Laying-position was performed by Lab.
 - The EUT in Laying position was found to be the worst case therefore this report includes relevant results.
 - Radiated spurious emissions were performed with the EUT positioned on the turn table and rotating 360 degrees while the antenna height varies from 1 to 4 m over the measurement frequency range.
 - EMC32 V10.1.0 Software was used for the Radiated spurious emission measurement.

5. Measurements, Examinations and Derived Results

5.1. General Comments

Measurement uncertainties are evaluated in accordance with current best practice. Our reported expanded uncertainties are based on Boost uncertainties, which are multiplied by an appropriate coverage factor to provide a statistical confidence level of approximately 95%. Please refer to Section 6 *Measurement Uncertainty* for details.

In accordance with DAkkS requirements all the measurement equipment is on a calibration schedule. All equipment was within the calibration period on the date of testing.

5.2. Test Results

5.2.1. Transmitter 20 dB Bandwidth

Test Summary:

Test Engineer:	Abdoufataou Salifou	Test Date:	05 September 2019
Test Sample Serial Number:	T1		
Test Site Identification	SR 9		

FCC Reference:	Part 2.1049
Test Method Used:	ANSI C63.10 Section 6.9.2

Environmental Conditions:

Temperature (°C):	23.8
Relative Humidity (%):	40

Notes:

1. The test receiver resolution bandwidth was set to 5 kHz and video bandwidth 20 kHz. A Peak detector was used, sweep time was set to auto and the trace mode was Max Hold. The span was set to 500 kHz. Normal and delta markers were placed 20 dB down from the peak of the carrier. These results are documented in the table below.
2. The RF port on the EUT was connected to the spectrum analyser using suitable attenuation and RF cable. The measured values takes into consideration the external attenuation correction factors.
3. The SMA (Female) RF Cable soldered on PCB with maximum attenuation 5.0 dB@ tested frequencies of which 0.5 dB was already added to a reference level offset to each of the conducted plots & additional 4.5 dB attenuation has been corrected from plot values.
4. The RF cable attenuation (maximum 0.4 dB at the tested frequencies) from the EUT to Analyzer including the 10 dB attenuation at the Spectrum Analyzer input and 0.5 dB for the SMA RF-cable attenuation was added as a reference level offset (10.9 dB) to each of the conducted plots.

Test setup:

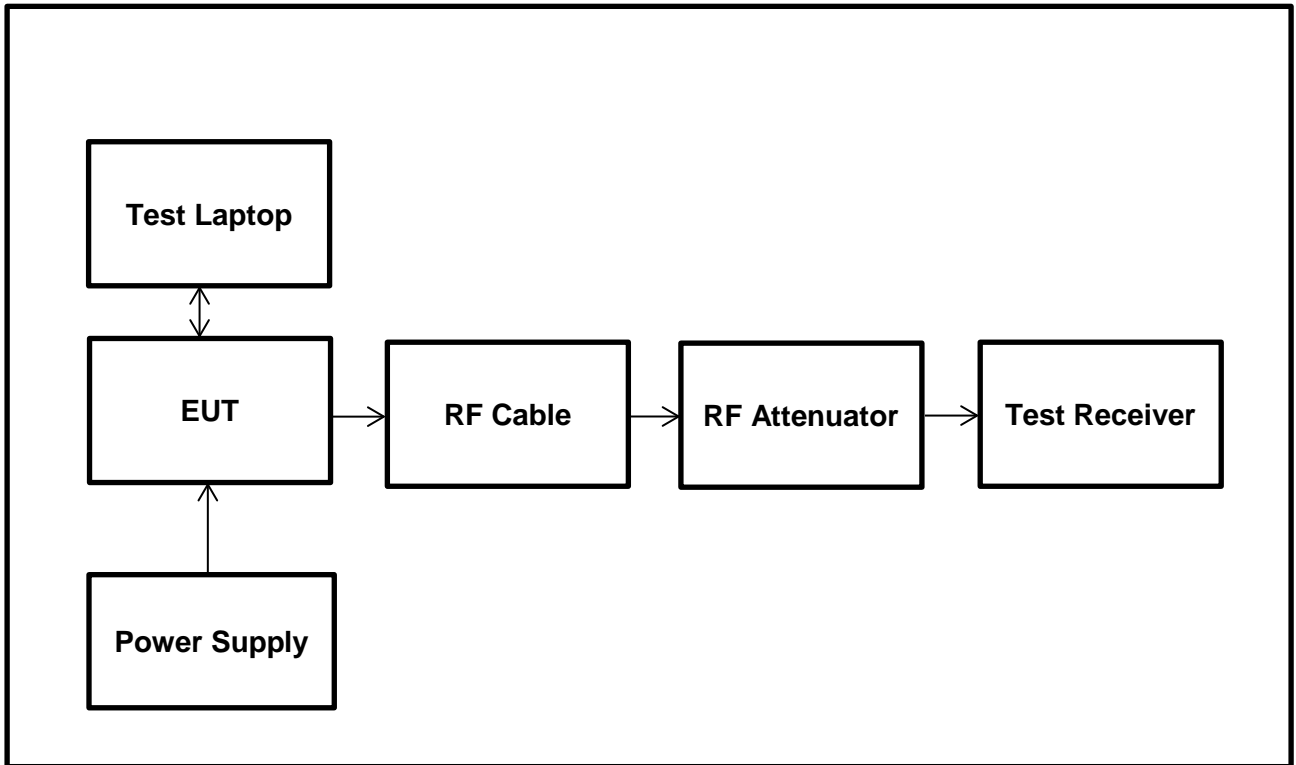

Transmitter 20 dB Bandwidth (continued)

Results: Boost Mode

Channel	20 dB Bandwidth (kHz)
Bottom	110.168
Middle	110.934
Top	111.590

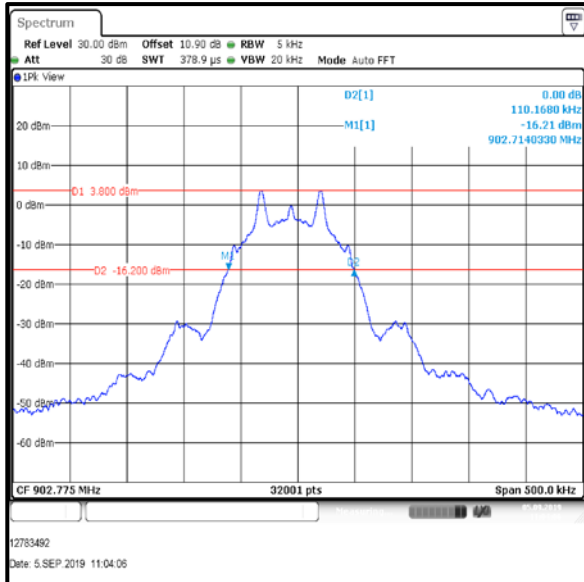

Bottom Channel

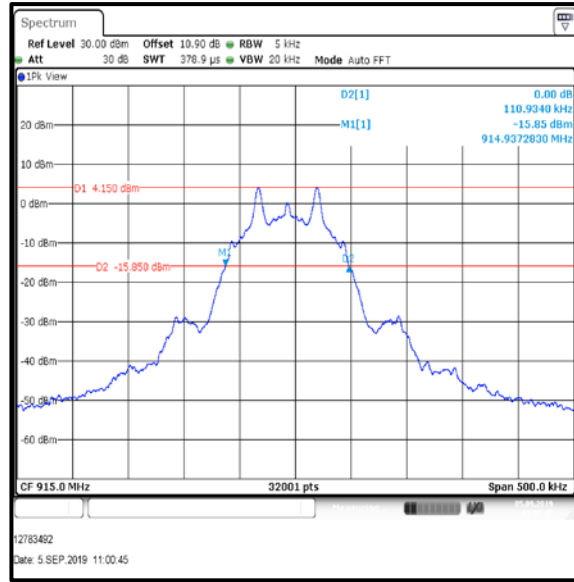

Middle Channel

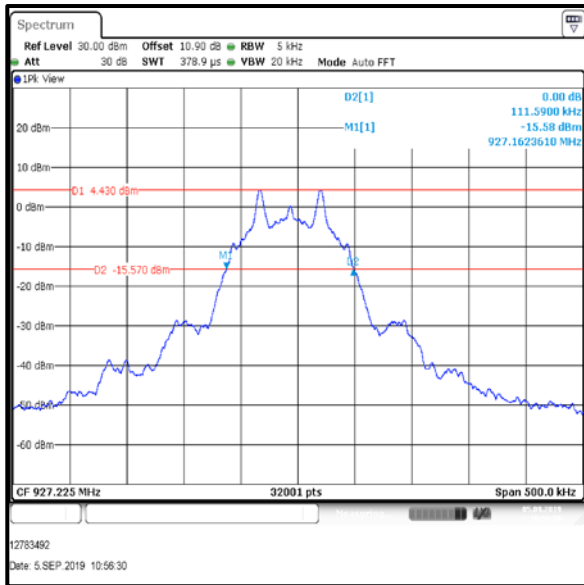

Top Channel

[Plots indicate 20 dB Bandwidth without 4.5 dB Attenuation correction for SMA (Female) RF Cable soldered on PCB; this does make any difference to the measurement]

Result: Pass

5.2.2. Transmitter Duty Cycle

Test Summary:

Test Engineers:	Abdoufataou Salifou & Krume Ivanov	Test Dates:	02 September & 05 December 2019
Test Sample Serial Number:	T1 & U10		
Test Site Identification	SR 1/2 & SR 9		

FCC Reference:	Part 15.35(c)
Test Method Used:	ANSI C63.10 Section 7.5

Environmental Conditions:

Temperature (°C):	23.8 & 22.3
Relative Humidity (%):	40 & 38

Note(s):

1. Since conducted & radiated EUT samples were transmitting with different duty cycle values; both of duty cycles are recorded.

2. The transmitter duty cycle was measured using a spectrum analyser in the time domain and calculated by using the following calculation:

$$10 \log (1 / (On\ Time / [Period\ or\ 100\ ms\ whichever\ is\ the\ lesser]))$$

Test Setup for the conducted sample:

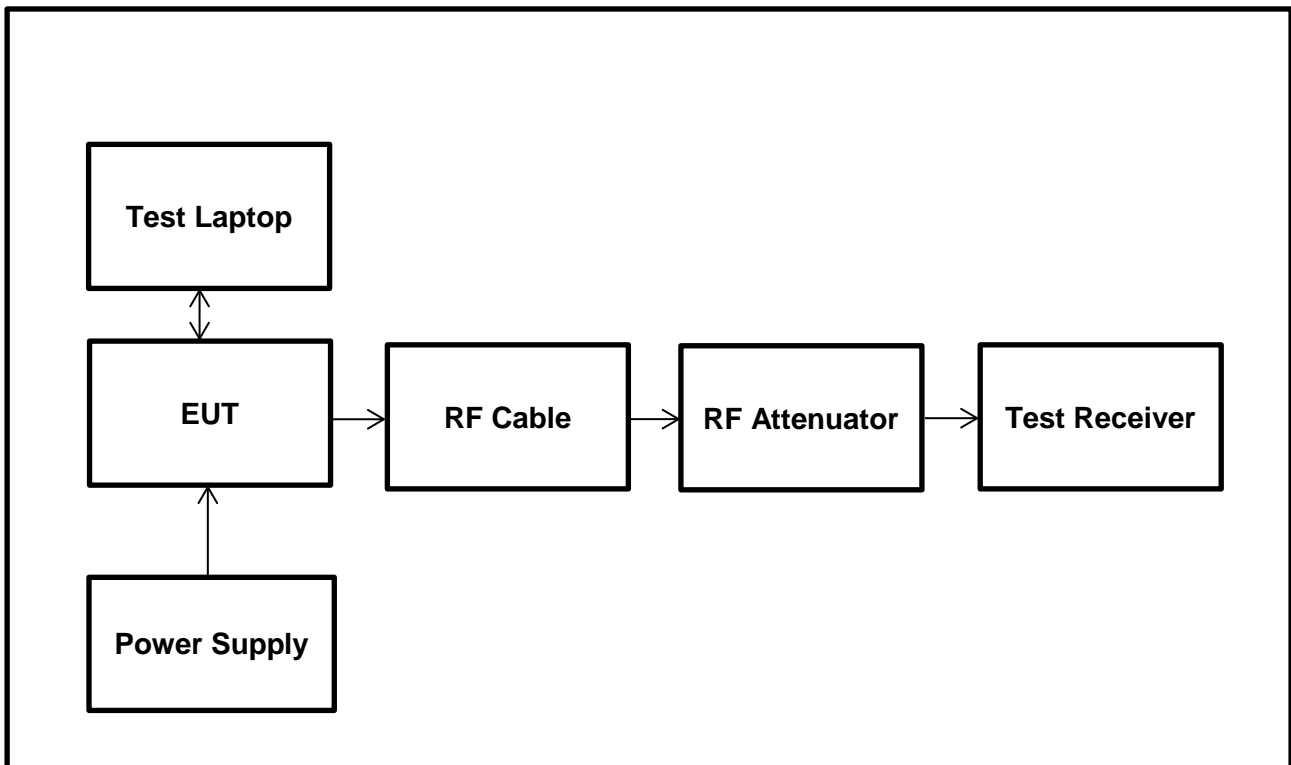

Transmitter Duty Cycle (continued)

Results: Conducted EUT

Pulse On Time (T _{ON}) (ms)	Pulse Period (T _{ON} + T _{OFF}) (ms)	Duty Cycle (%)	Duty Cycle Correction Factor (dB)
449.921	452.671	99.39	0.0

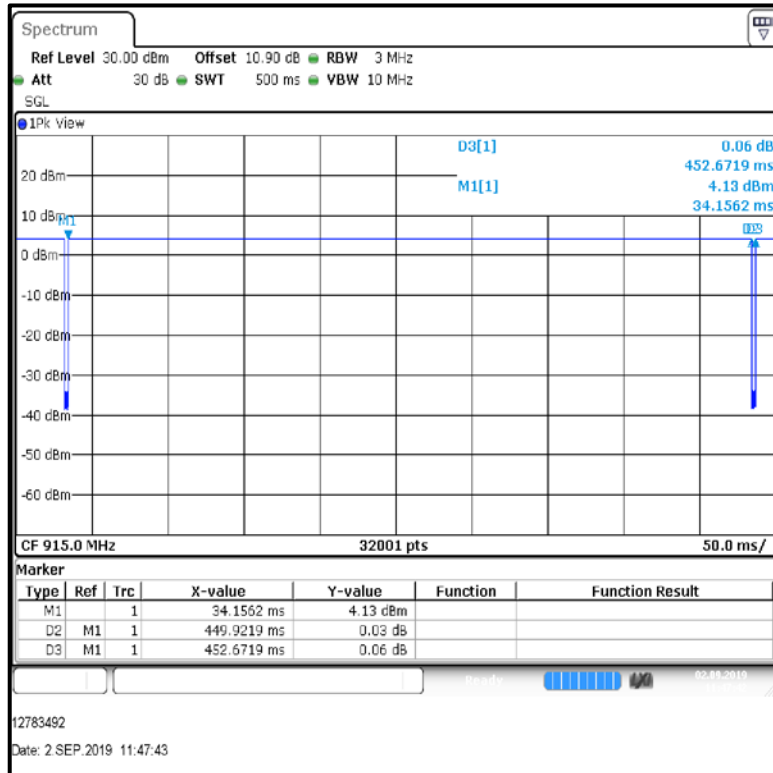

Transmitter Duty Cycle (continued)

Test Setup for the radiated Sample:

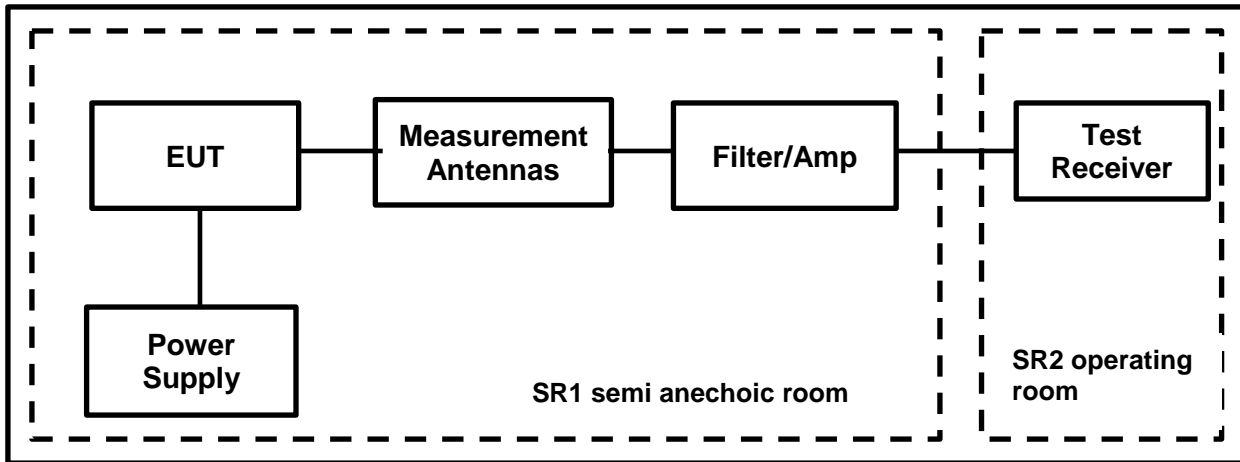

Transmitter Duty Cycle (continued)

Results: Radiated EUT

Pulse On Time (T _{ON}) (ms)	Pulse Period (T _{ON} + T _{OFF}) (ms)	Duty Cycle (%)	Duty Cycle Correction Factor (dB)
5.878	81.646	7.19	11.42

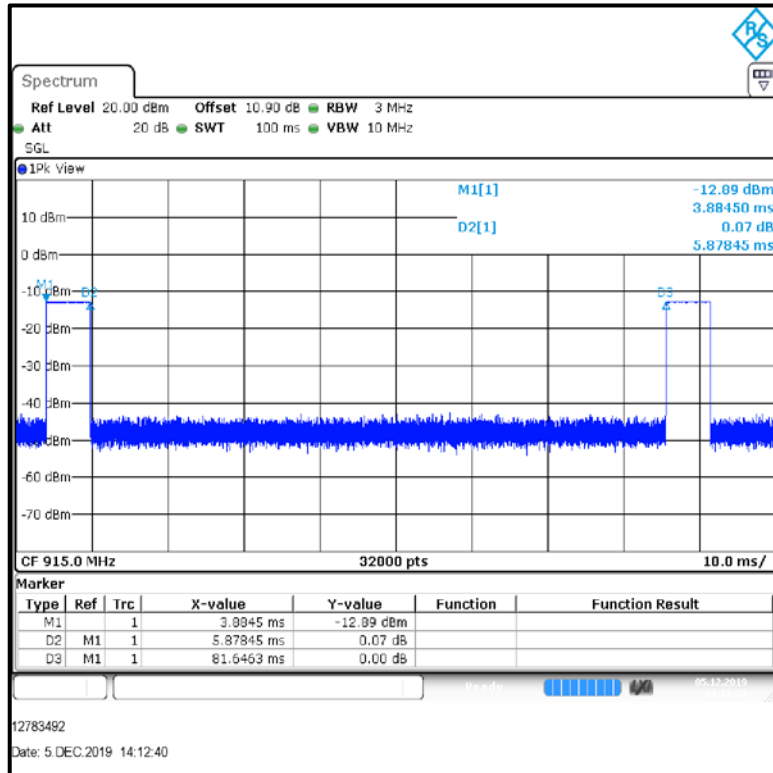

5.2.3. Transmitter Fundamental Field Strength**Test Summary:**

Test Engineer:	Krume Ivanov	Test Date:	05 December 2019
Test Sample Serial Number:	U7,U8,U9		
Test Site Identification	SR 1/2		

FCC Reference:	Part 15.249(a)
Test Method Used:	ANSI C63.10 Section 6.5

Environmental Conditions:

Temperature (°C):	22.5
Relative Humidity (%):	30

Notes:

1. Measurements were performed in a semi anechoic chamber SR1/ 2 (Asset Number 1603665) at a distance of 3 meters. The EUT was placed at a height of 80 cm above the reference ground plane in the centre of the chamber turntable. Maximum emission levels were determined by height searching the measurement antenna over the range 1 meter to 4 meters.
2. The final measured value, for the given emission, in the table below incorporates the calibrated antenna factor and cable loss.
3. The test receiver resolution bandwidth was set to 200 kHz > (20 dB bandwidth) and video bandwidth of 600 kHz. A peak detector was used, sweep time was set to auto and trace mode was Max Hold. The span was set to 1 MHz. A marker was placed at the peak of the signal and the results recorded in the tables below.

Transmitter Fundamental Field Strength (continued)

Test Setup:

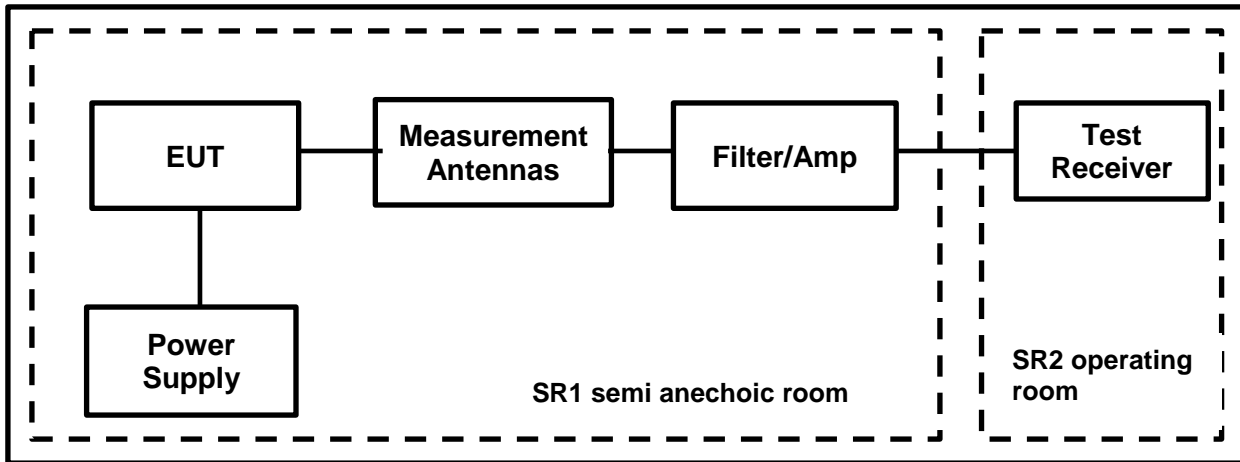

Transmitter Fundamental Field Strength (continued)**Results: Boost Mode / Bottom Channel**

Frequency (MHz)	Antenna Polarization	Peak Level (dB μ V/m)	Limit (dB μ V/m)	Margin (dB)	Result
902.775	Horizontal	76.45	94.00	17.55	Complied

Results: Boost Mode / Middle Channel

Frequency (MHz)	Antenna Polarization	Peak Level (dB μ V/m)	Limit (dB μ V/m)	Margin (dB)	Result
915.000	Horizontal	78.71	94.00	15.29	Complied

Results: Boost Mode / Top Channel

Frequency (MHz)	Antenna Polarization	Peak Level (dB μ V/m)	Limit (dB μ V/m)	Margin (dB)	Result
927.225	Horizontal	78.36	94.00	15.64	Complied

Result: Pass

Transmitter Fundamental Field Strength (continued)

Results: Boost Mode

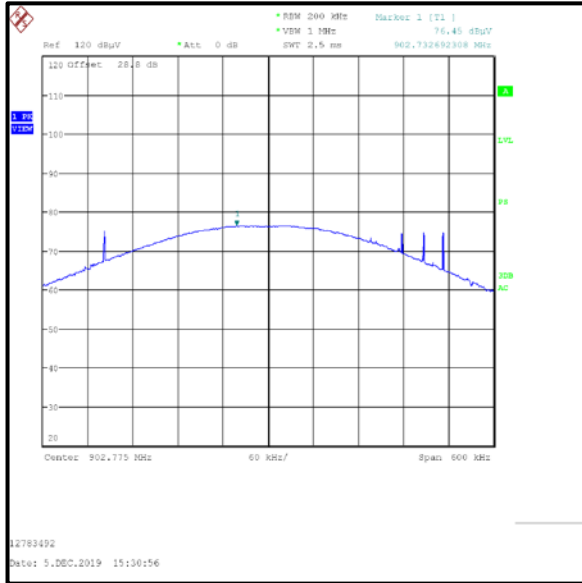

Bottom Channel

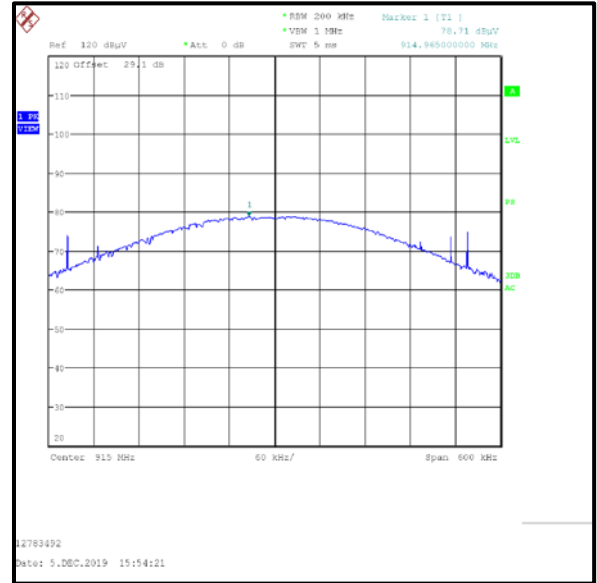

Middle Channel

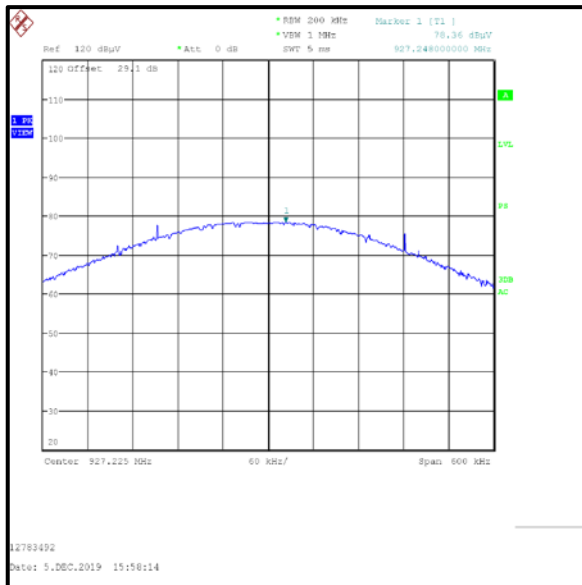

Top Channel

Result: **Pass**

5.2.4. Transmitter Radiated Emissions**Test Summary:**

Test Engineer:	Krume Ivanov	Test Date:	03 September 2019
Test Sample Serial Number:	U7		
Test Site Identification	SR 1/2		

FCC Reference:	Parts 15.249(a)(d)(e) & 15.209(a)
Test Method Used:	ANSI C63.10:2013 Sections 6.3 and 6.4
Frequency Range	9 kHz to 30 MHz

Environmental Conditions:

Temperature (°C):	21
Relative Humidity (%):	28

Note(s):

- In accordance with FCC KDB 414788, an alternative test site may be used for the measurement below 30 MHz (The OATS / SAC comparison data is available upon request). Therefore the result from the semi-anechoic chamber tests is shown in this section of the test report.
- The final measured value, for the given emission, in the table below incorporates the calibrated antenna factor and cable loss.
- The preliminary scans showed similar emission levels below 30 MHz, for fixed frequency mode for each channel. Therefore final radiated emissions measurements were performed with the EUT on the top channel only.
- All other emissions shown on the pre-scan plot were investigated and represent system noise floor.
- Measurements below 30 MHz were performed in a semi-anechoic chamber SR1/ 2 (Asset Number 1603665) at a distance of 3 meters. The EUT was placed at a height of 80 cm above the reference ground plane in the centre of the chamber turntable. Maximum emission levels were determined by searching the loop antenna polarizations set at height of 1 meter.
- Pre-scans were performed and markers placed on the highest measured levels. The test receiver resolution bandwidth was set to 10 kHz and video bandwidth 30 kHz. A peak detector was used, sweep time was set to auto and trace mode was Max Hold.
- Final measurements were performed on the marker frequencies and the results entered into the table below. The test receiver resolution bandwidth was set to 9 kHz, using a CISPR quasi-peak detector and span big enough to see the whole emission.

Transmitter Radiated Emissions (continued)

Test Setup:

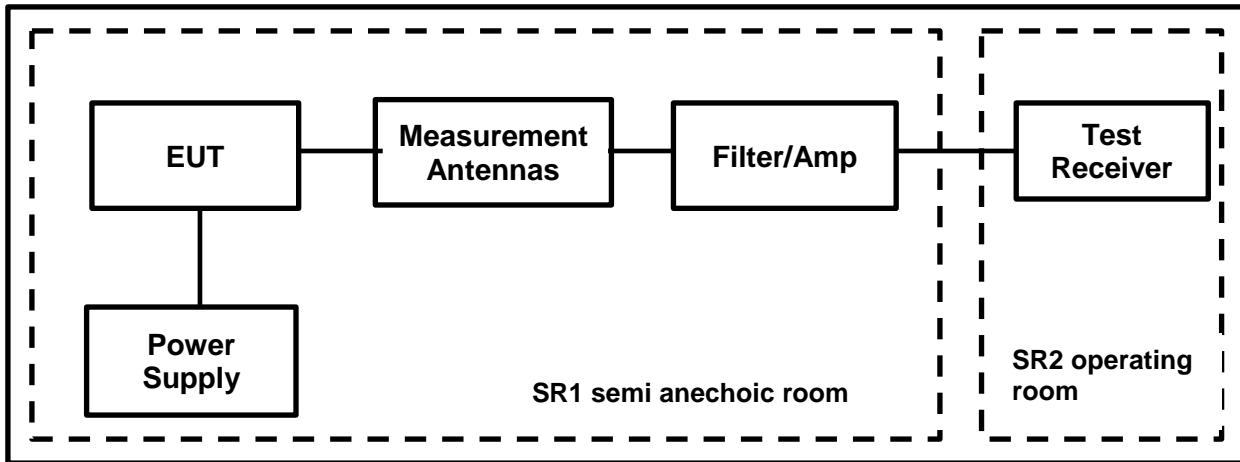

Transmitter Radiated Emissions (continued)

Results: Boost Mode / Top Channel

Frequency (MHz)	Antenna Polarization	Quasi Peak Level (dB μ V/m)	Limit (dB μ V/m)	Margin (dB)	Result
No critical spurious emissions were detected					

Radiated Transmitter spurious emission from 9 kHz – 30 MHz for the top channel

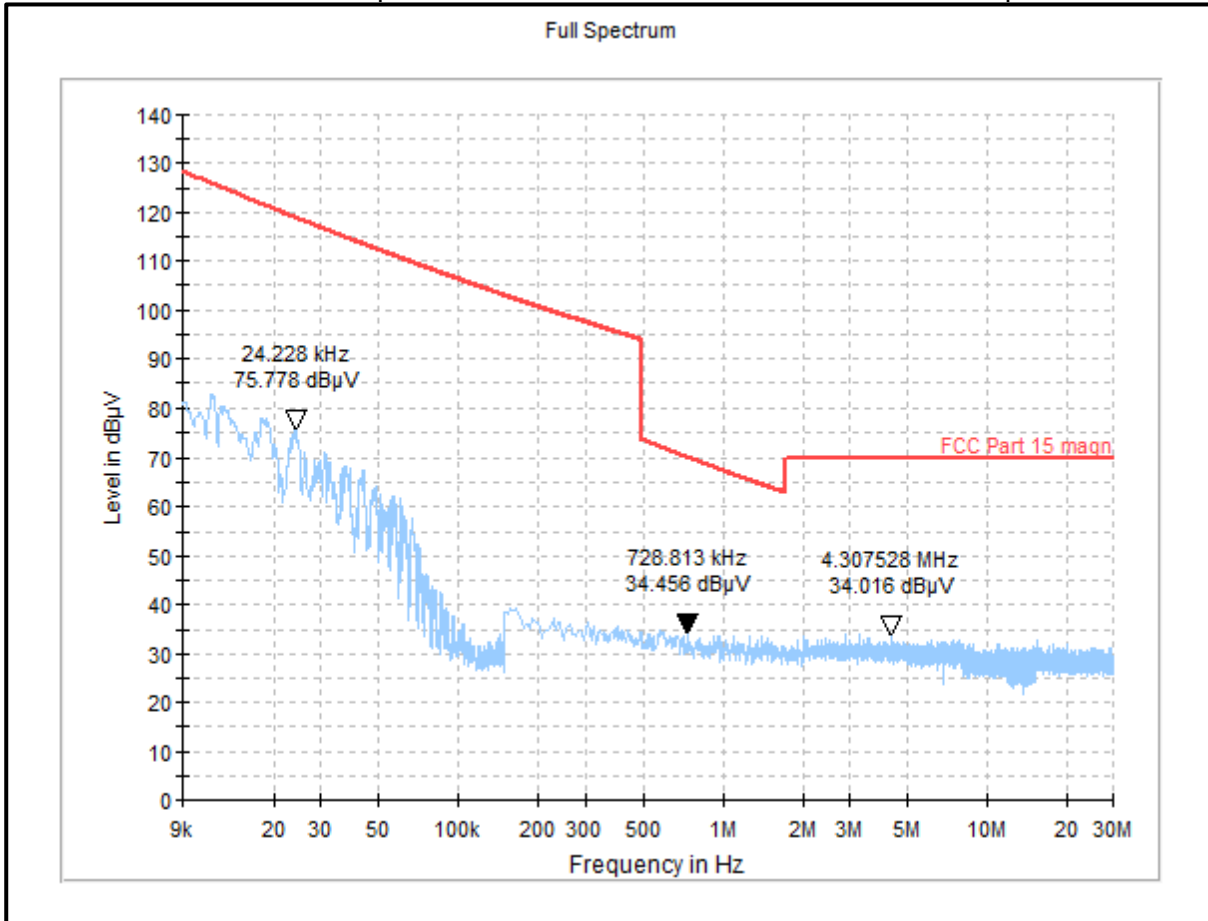

Note: This plot is a pre-scan and for indication purposes only. For final measurements, see accompanying table.

Result: Pass

Transmitter Radiated Emissions (continued)**Test Summary:**

Test Engineer:	Krume Ivanov	Test Date:	03 September 2019
Test Sample Serial Number:	U7		
Test Site Identification	SR 1/2		

FCC Reference:	Parts 15.249(a)(d)(e) & 15.209(a)
Test Method Used:	ANSI C63.10:2013 Sections 6.3 and 6.5
Frequency Range	30 MHz to 1000 MHz

Environmental Conditions:

Temperature (°C):	23
Relative Humidity (%):	40

Note(s):

1. The emissions shown at frequencies between approximately 903 to 927 MHz on the 30 MHz to 1 GHz plots are the EUT fundamental for the given channel.
2. The final measured value, for the given emission, in the table below incorporates the calibrated antenna factor and cable loss.
3. No spurious emissions were detected above the noise floor of the measuring receiver.
4. Measurements below 1 GHz were performed in a semi anechoic chamber SR1/2 (Asset Number 1603665) at a distance of 3 meters. The EUT was placed at a height of 80 cm above the reference ground plane in the centre of the chamber turntable. Maximum emission levels were determined by height searching the measurement antenna over the range 1 meter to 4 meters.
5. Pre-scans were performed and markers placed on the highest measured levels. The test receiver resolution bandwidth was set to 100 kHz and video bandwidth 300 kHz. The sweep time was set to auto. A peak detector was used, sweep time was set to auto and trace mode was Max Hold.

Transmitter Radiated Emissions (continued)

Results: Boost Mode / Bottom Channel

Frequency (MHz)	Antenna Polarization	Quasi Peak Level (dBµV/m)	Limit (dBµV/m)	Margin (dB)	Result
No spurious emissions were detected					

Results: Boost Mode / Middle Channel

Frequency (MHz)	Antenna Polarization	Quasi Peak Level (dBµV/m)	Limit (dBµV/m)	Margin (dB)	Result
No spurious emissions were detected					

Results: Boost Mode / Top Channel

Frequency (MHz)	Antenna Polarization	Quasi Peak Level (dBµV/m)	Limit (dBµV/m)	Margin (dB)	Result
No spurious emissions were detected					

Result: **Pass**

Transmitter Radiated Emissions (continued)

Boost Mode

Radiated Transmitter spurious emission from 30 MHz – 1 GHz for the bottom channel

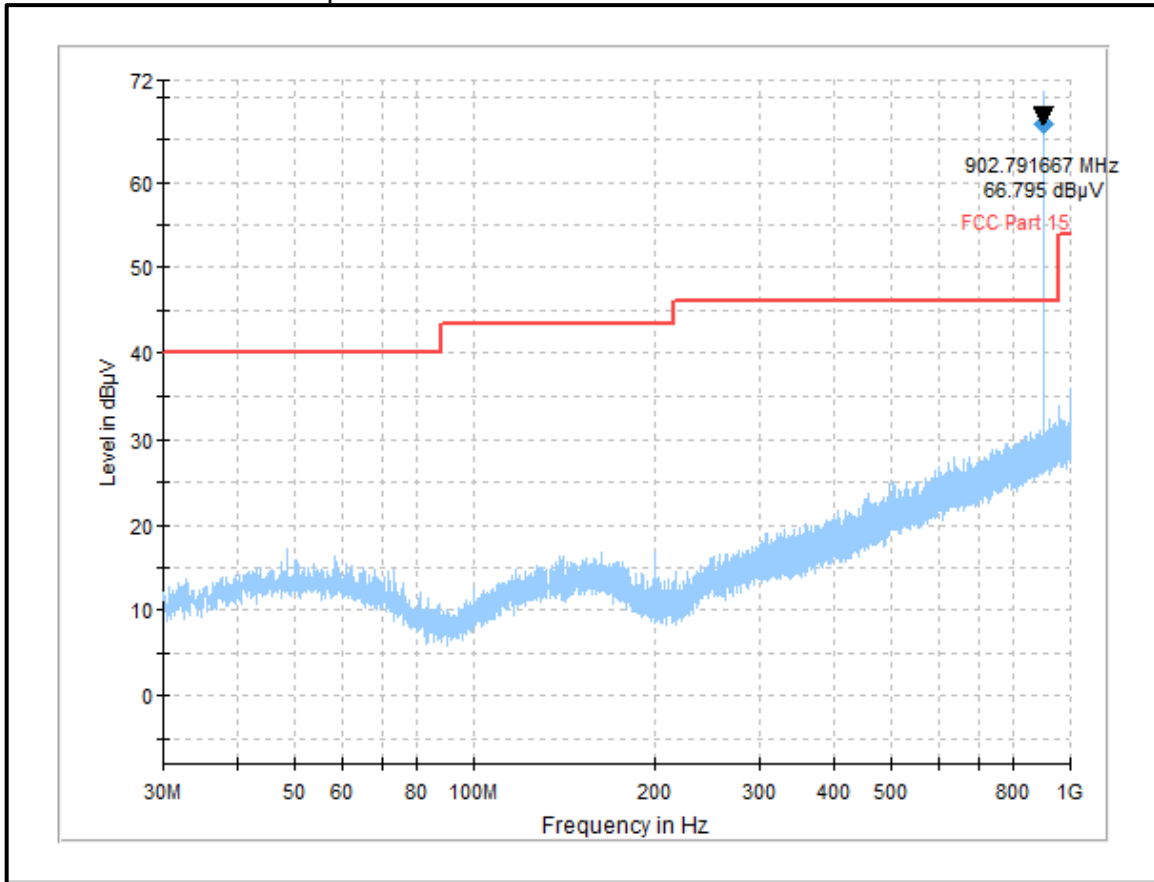

Result: Pass

Transmitter Radiated Emissions (continued)

Boost Mode

Plot: Radiated Transmitter spurious emission from 30 MHz – 1 GHz for the middle channel

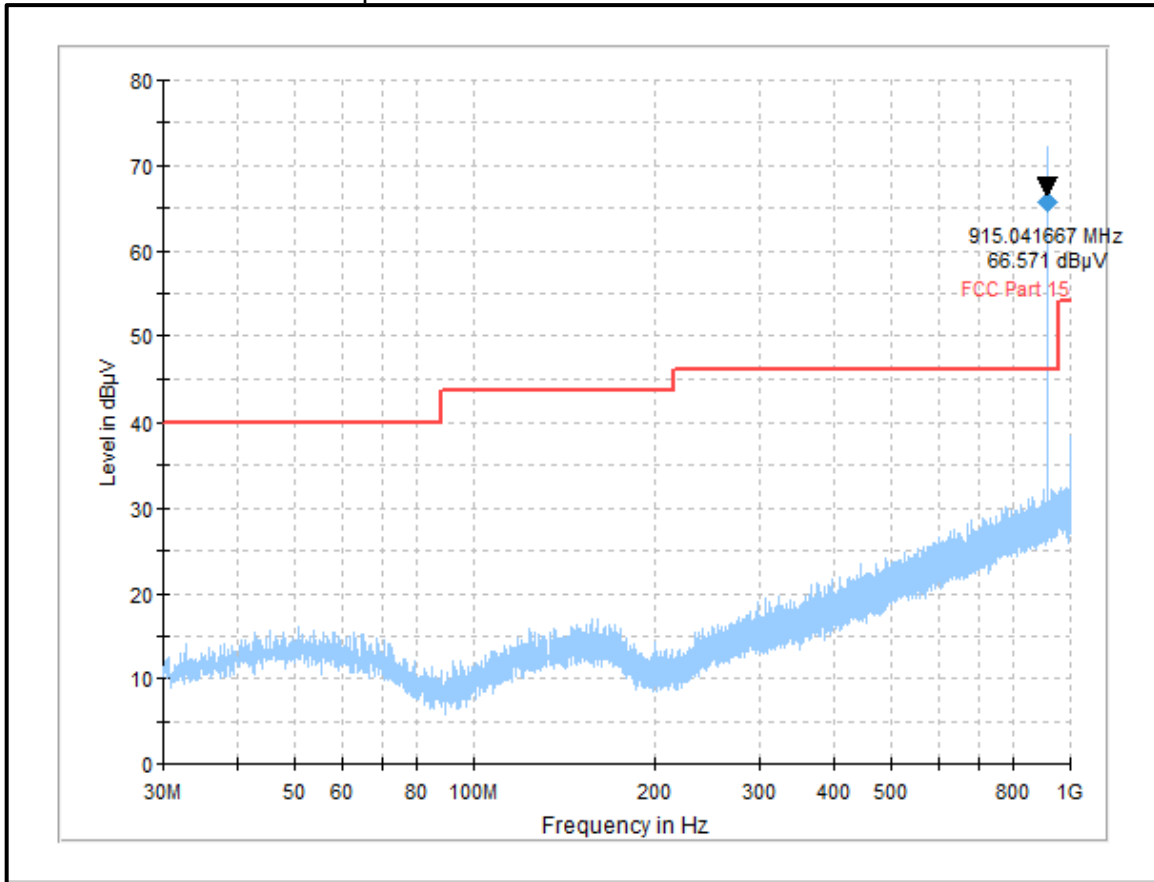

Result: Pass

Transmitter Radiated Emissions (continued)

Boost Mode

Plot: Radiated Transmitter spurious emission from 30 MHz – 1 GHz for the top channel

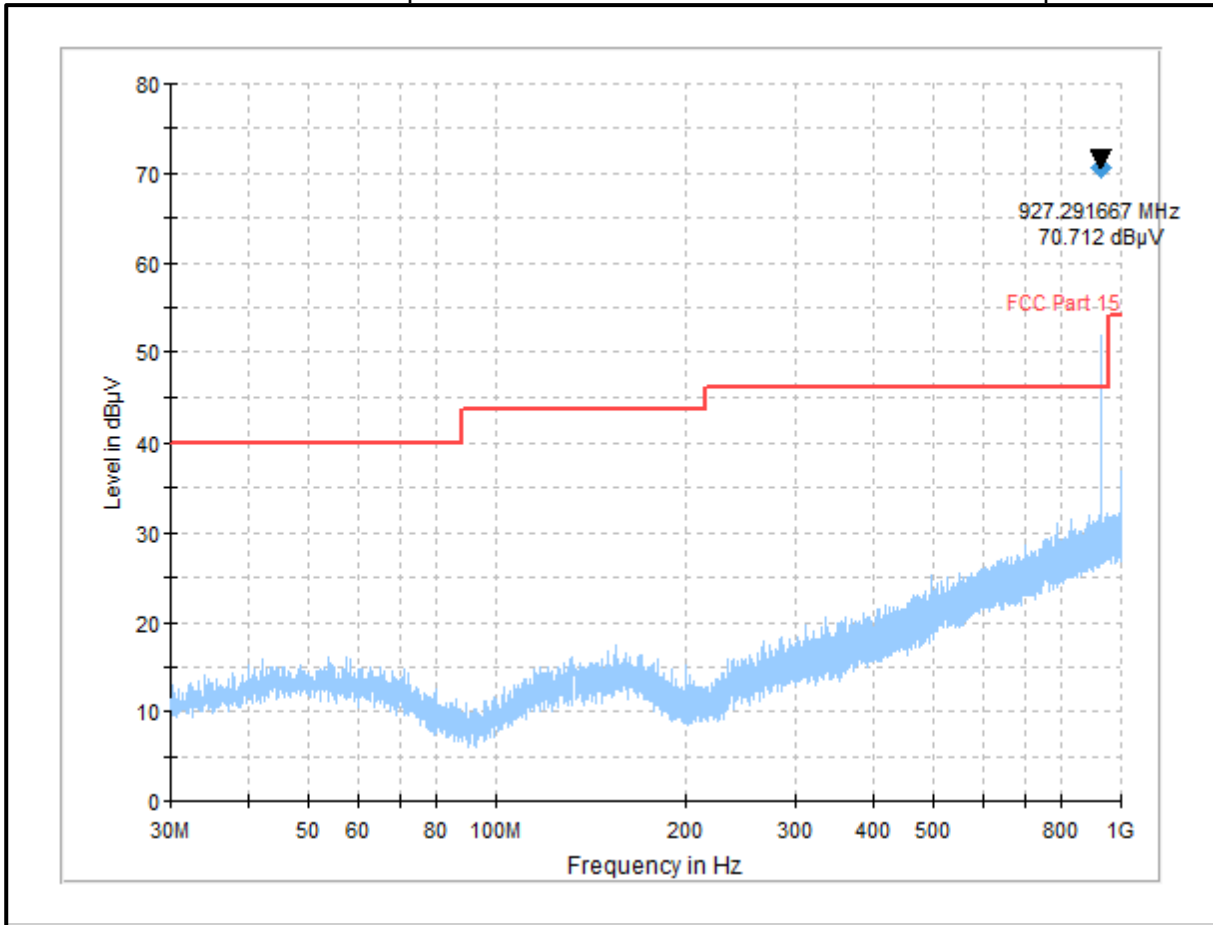

Note: These plots are pre-scans and for indication purposes only. For final measurements, see accompanying table.

Result: **Pass**

Transmitter Radiated Emissions (continued)**Test Summary:**

Test Engineer:	Krume Ivanov	Test Date:	04 September 2019
Test Sample Serial Number:	U9		
Test Site Identification	SR 1/2		

FCC Reference:	Parts 15.249(a)(d)(e) & 15.209(a)
Test Method Used:	ANSI C63.10:2013 Sections 6.3 and 6.6
Frequency Range	1 GHz to 10 GHz

Environmental Conditions:

Temperature (°C):	23
Relative Humidity (%):	28

Note(s):

1. The final measured value, for the given emission, in the table below incorporates the calibrated antenna factor and cable loss.
2. Pre-scans above 1 GHz were performed in a semi anechoic chamber SR1/ 2 (Asset Number 1603665) with absorbers on the ground at a distance of 3 meters. The EUT was placed at a height of 1.5 m above the test chamber floor in the centre of the chamber turntable. All measurement antennas were placed at a fixed height of 1.5 meters above the test chamber floor, in line with the EUT. Final measurements above 1 GHz were performed in a semi anechoic chamber SR1/ 2 (Asset Number 1603665) with absorbers on the ground at a distance of 3 meters. The EUT was placed at a height of 1.5 m above the reference ground plane in the centre of the chamber turntable. Maximum emission levels were determined by height searching the measurement antenna over the range 1 meter to 4 meters.
3. Pre-scans were performed and a marker placed on the highest measured level of the appropriate plot. The test receiver resolution bandwidth was set to 1 MHz and video bandwidth 3 MHz. The sweep time was set to auto.
4. *In accordance with ANSI C63.10 Section 6.6.4.3, if the peak measured value complies with the average limit, it is unnecessary to perform an average measurement.

Transmitter Radiated Emissions (continued)

Test Setup:

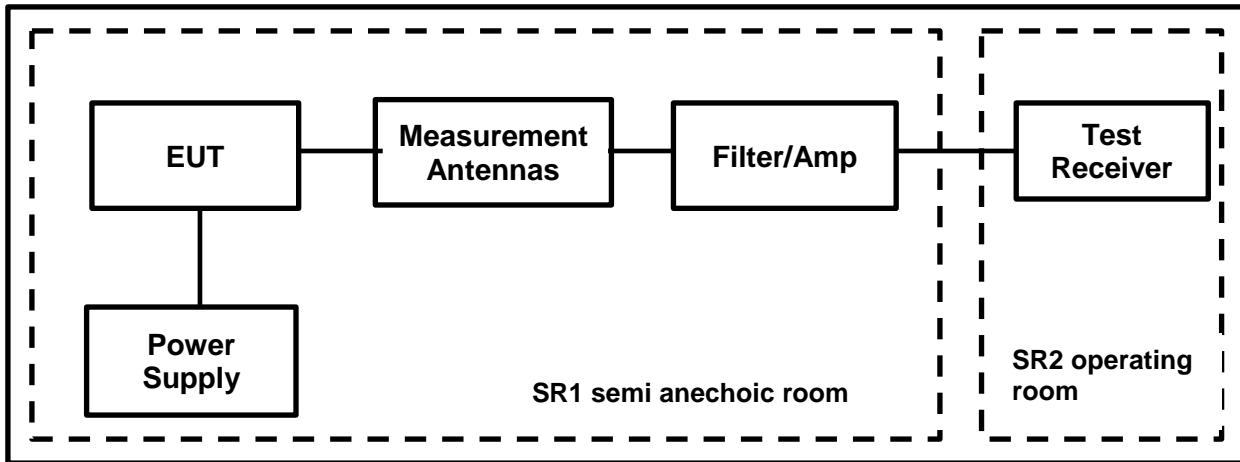

Transmitter Radiated Emissions (continued)**Results: Boost Mode / Peak Detector/ Bottom Channel**

Frequency (MHz)	Antenna Polarization	Peak Level (dB μ V/m)	Average Limit (dB μ V/m)	Margin (dB)	Result
3127.050	Horizontal	46.40	54.00	7.60	Complied
3573.300	Horizontal	46.74	54.00	7.26	Complied
4217.500	Horizontal	49.61	54.00	4.39	Complied

Results: Boost Mode / Peak Detector/ Middle Channel

Frequency (MHz)	Antenna Polarization	Peak Level (dB μ V/m)	Average Limit (dB μ V/m)	Margin (dB)	Result
3100.700	Vertical	45.98	54.00	8.02	Complied
4788.000	Horizontal	51.61	54.00	2.39	Complied

Results: Boost Mode / Peak Detector/ Top Channel

Frequency (MHz)	Antenna Polarization	Peak Level (dB μ V/m)	Average Limit (dB μ V/m)	Margin (dB)	Result
3446.225	Vertical	47.51	54.00	6.49	Complied

Result: Pass

Transmitter Radiated Emissions (continued)

Boost Mode

Plot: Radiated Transmitter spurious emission from 1 GHz – 10 GHz for the bottom channel

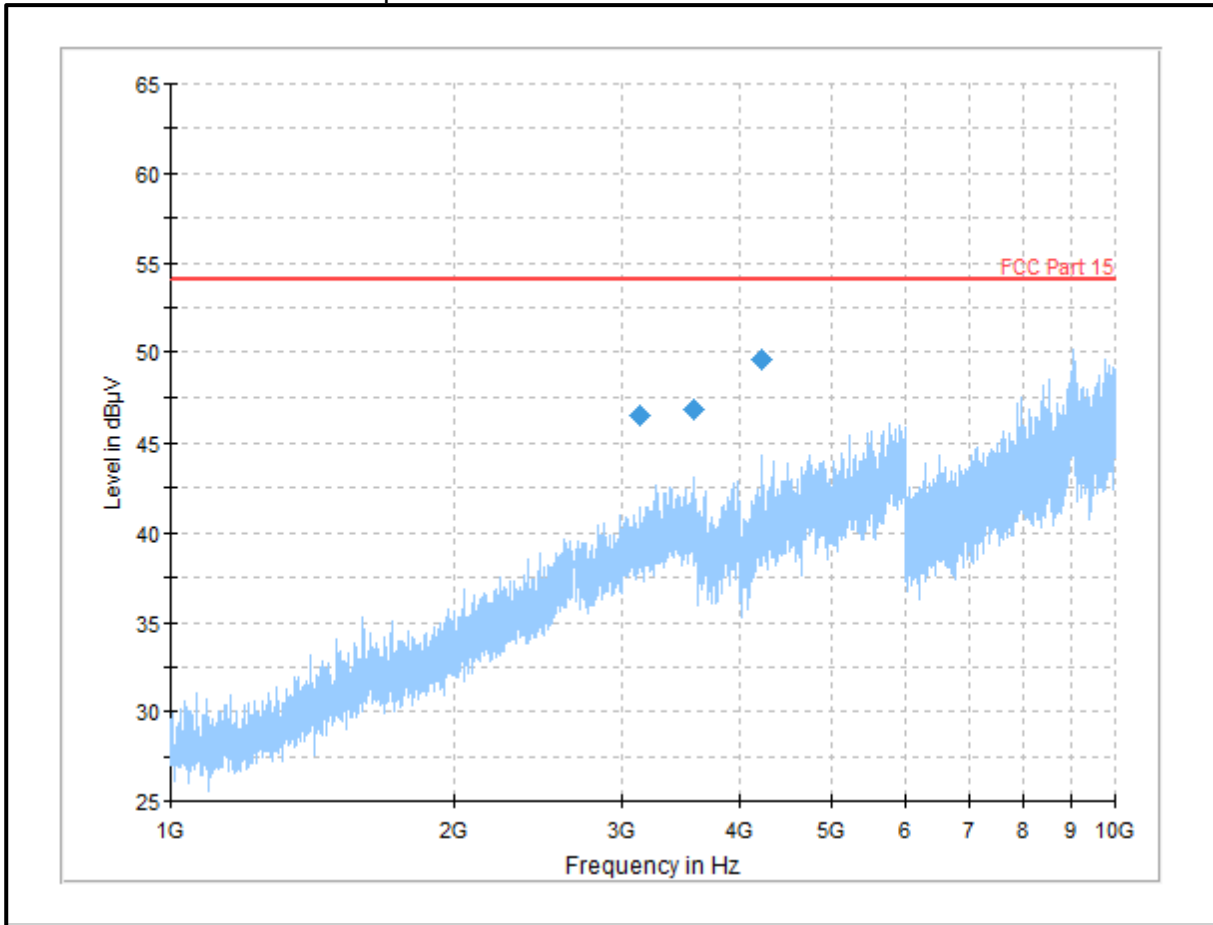

Result: Pass

Transmitter Radiated Emissions (continued)

Boost Mode

Plot: Radiated Transmitter spurious emission from 1 GHz – 10 GHz for the middle channel

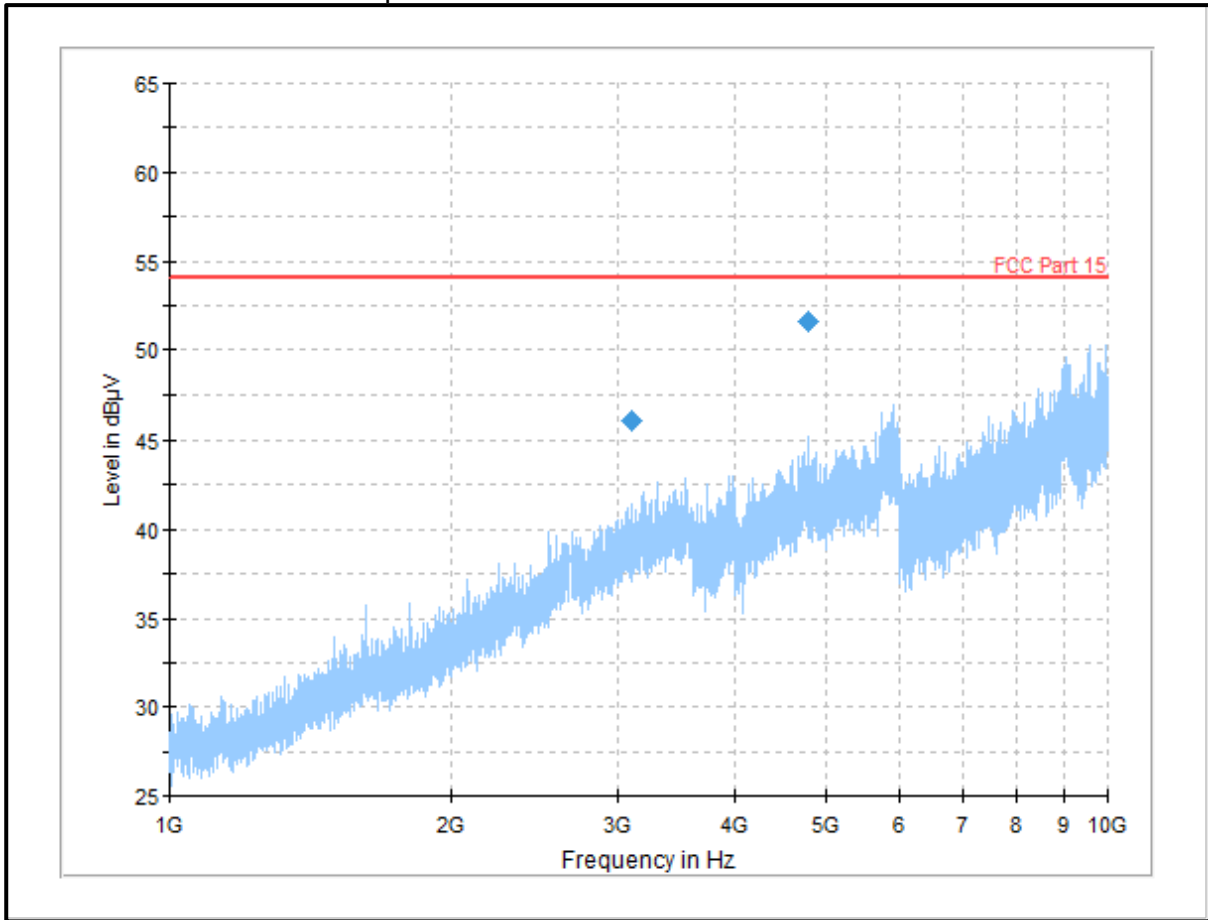

Result: **Pass**

Transmitter Radiated Emissions (continued)

Boost Mode

Plot: Radiated Transmitter spurious emission from 1 GHz – 10 GHz for the top channel

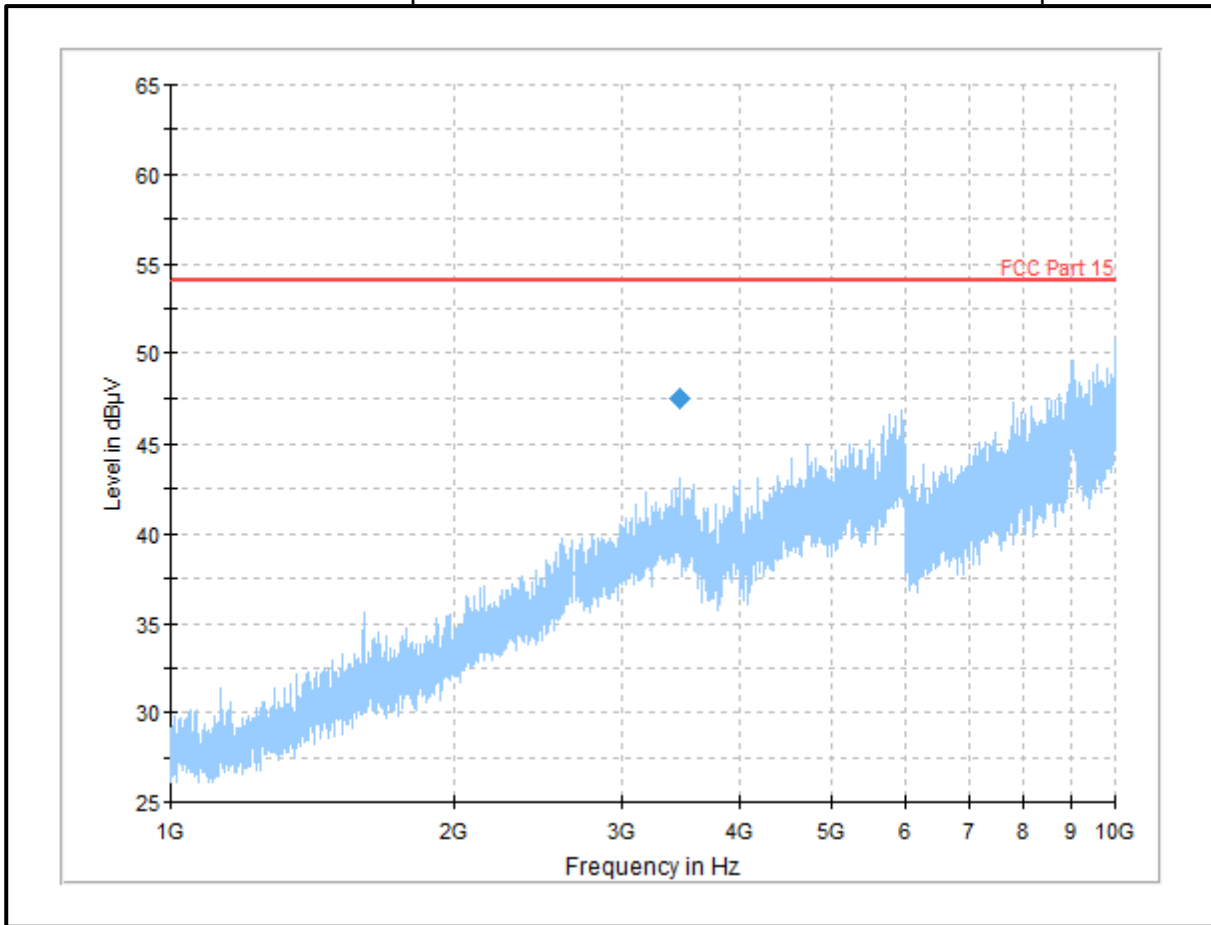

Note: These plots are pre-scans and for indication purposes only. For final measurements, see accompanying table.

Result: Pass

5.2.5. Transmitter Band Edge Radiated Emissions

Test Summary:

Test Engineer:	Krume Ivanov	Test Date:	03 September 2019
Test Sample Serial Number:	U3, U4		
Test Site Identification	SR 1/2		

FCC Reference:	Parts 15.249(d) & 15.209
Test Method Used:	ANSI C63.10 Section 6.10.4, 6.10.5

Environmental Conditions:

Temperature (°C):	25
Relative Humidity (%):	31

Notes:

1. The tests were performed in a semi anechoic chamber SR1/ 2 (Asset Number 1603665) at a distance of 3 metres. The EUT was placed at a height of 1.5 metres above the test chamber floor in the centre of the chamber turntable. All measurement antennas were placed at a fixed height of 1.5 metres above the test chamber floor, in line with the EUT. Final measurements were performed in a semi-anechoic chamber SR1/ 2 (Asset Number 1603665) at a distance of 3 metres. The EUT was placed at a height of 1.5 m above the reference ground plane in the centre of the chamber turntable. Maximum emission levels were determined by height searching the measurement antenna over the range 1 metre to 4 metres.
2. The final measured value, for the given emission, in the table below incorporates the calibrated antenna factor and cable loss.
3. As both band edges are adjacent to non-restricted bands, only -20 dBc peak measurements are required. The plots shown on the following page were performed using a peak detector as this was deemed worst case.
4. The test receiver resolution bandwidth was set to 100 kHz and video bandwidth 300 kHz. A peak detector was used, sweep time was set to auto and trace mode was Max Hold. The test receiver was left to sweep for a sufficient length of time in order to maximise the carrier level and out-of-band emissions. A marker and corresponding reference level line were placed on the peak of the carrier. Marker frequencies and levels were recorded.

Test Setup:

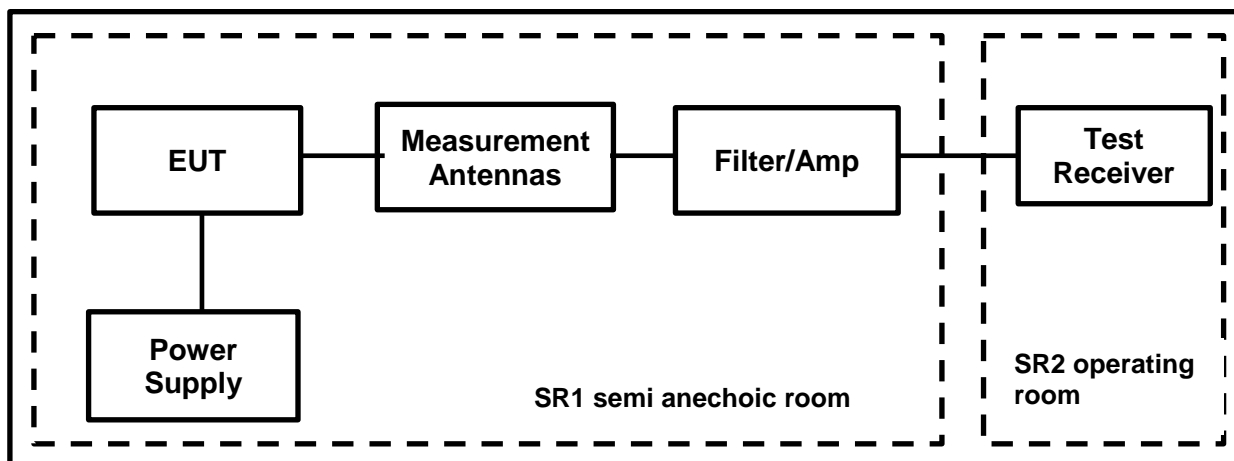

Transmitter Band Edge Radiated Emissions (continued)**Results: Boost Mode / Lower Band Edge / Peak**

Frequency (MHz)	Antenna Polarization	Peak Level (dB μ V/m)	-20 dBc Limit (dB μ V/m)	Margin (dB)	Result
897.945	Horizontal	40.77	55.18	14.41	Complied
902.000	Horizontal	39.90	55.18	15.28	Complied

Results: Boost Mode / Upper Band Edge / Peak

Frequency (MHz)	Antenna Polarization	Peak Level (dB μ V/m)	-20 dBc Limit (dB μ V/m)	Margin (dB)	Result
928.000	Horizontal	39.05	57.82	18.77	Complied
930.051	Horizontal	41.16	57.82	16.66	Complied

Result: Pass

Transmitter Band Edge Radiated Emissions (Continued)

Results: Boost Mode

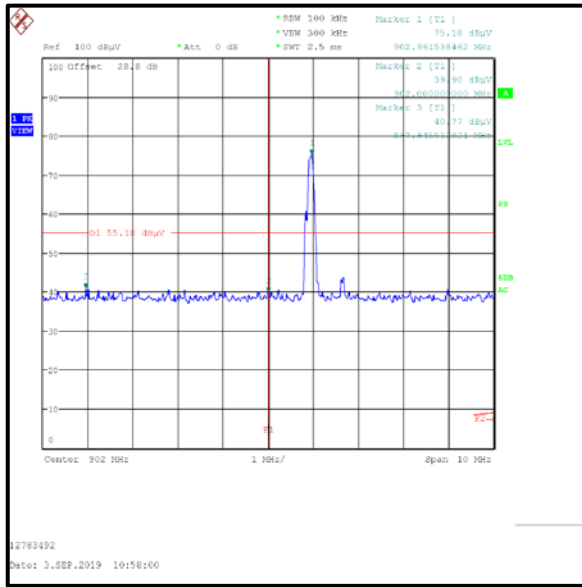

Lower Band Edge Peak Measurement

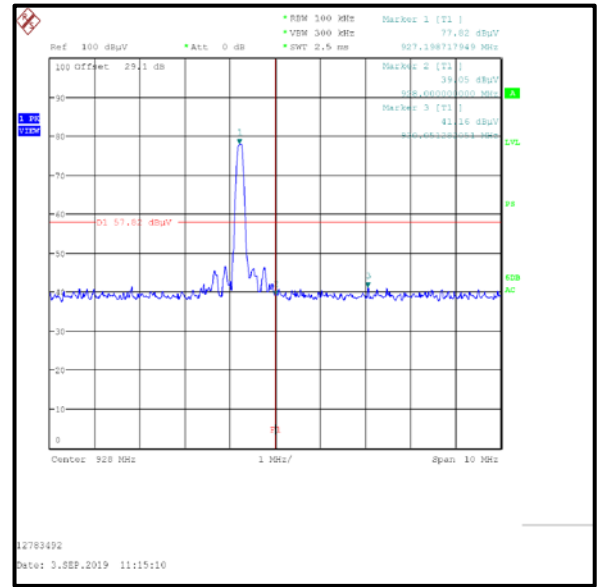

Upper Band Edge Peak Measurement

6. Measurement Uncertainty

The expression of uncertainty of a measurement result allows realistic comparison of results with reference values and limits given in specifications and Boosts.

The uncertainty of the result may need to be taken into account when interpreting the measurement results.

The reported expanded uncertainties below are based on a Boost uncertainty multiplied by an appropriate coverage factor such that a confidence level of approximately 95% is maintained. For the purposes of this document "approximately" is interpreted as meaning "effectively" or "for most practical purposes".

Measurement Type	Confidence Level (%)	Calculated Uncertainty
20 dB Bandwidth	95%	±0.87 %
Transmitter Duty Cycle (conducted)	95%	±3.4%
Transmitter Duty Cycle (radiated)	95%	±3.4%
Fundamental Field Strength	95%	±3.10 dB
Radiated Spurious Emissions	95%	±3.10 dB
Band Edge Radiated Emissions	95%	±3.10 dB

The methods used to calculate the above uncertainties are in line with those recommended within the various measurement specifications. Where measurement specifications do not include guidelines for the evaluation of measurement uncertainty the published guidance of the appropriate accreditation body is followed.

7. Used equipment

Test site: SR 1/2

ID	Manufacturer	Type	Model	Serial	Calibration Date	Cal. Cycle (months)
1	Rohde & Schwarz	Antenna, Loop	HFH2-Z2	831247/012	7/11/2019	36
377	BONN Elektronik	Amplifier, Low Noise Pre	BLMA 0118-1A	025294B	7/10/2019	12
423	Bonn Elektronik	Amplifier, Low Noise Pre	BLMA 1840-1A	55929	7/16/2019	12
460	Deisl	Turntable	DT 4250 S	n/a	n/a	n/a
465	Schwarzbeck	Antenna, Trilog Broadband	VULB 9168	9168-240	3/20/2019	24
496	Rohde & Schwarz	Antenna, log. - periodical	HL050	100297	2/19/2019	36
587	Maturo	antenna mast, tilting	TAM 4.0-E	011/7180311	n/a	n/a
588	Maturo	Controller	NCD	029/7180311	n/a	n/a
591	Rohde & Schwarz	Receiver	ESU 40	100244/040	7/9/2019	12
608	Rohde & Schwarz	Switch Matrix	OSP 120	101227	lab verification	n/a
628	Maturo	Antenna mast	CAM 4.0-P	224/19590716	n/a	n/a
629	Maturo	Kippeinrichtung	KE 2.5-R-M	MAT002	n/a	n/a
-/-	Testo	Thermo-Hygrometer	608-H1	01	lab verification	n/a

Test site: SR 9

ID	Manufacturer	Type	Model	Serial	Calibration Date	Cal. Cycle (months)
423	Bonn Elektronik	Amplifier, Low Noise Pre	BLMA 1840-1A	55929	7/16/2019	12
445	Huber & Suhner	RF Attenuator (10dB)	6810.17.AC	--	Cal Before Use	12
621	Ahlborn-Almemo	Temperatur-/ Feuchtemessgerät	MA2470-S2	H16080099	3/15/2019	12
634	Rohde & Schwarz	Wireless Devices Test System	TS8997	--	lab verification	12
636	Rohde & Schwarz	switching unit	OSP120	101698	7/19/2019	12
637	Rohde & Schwarz	Spectrum Analyzer	FSV40	101587	7/11/2019	12
-/-	Testo	Thermo-Hygrometer	608-H1	07	lab verification	n/a

8. Report Revision History

Version Number	Revision Details		
	Page No(s)	Clause	Details
1.0	-	-	Initial Version

--- END OF REPORT ---