

尺寸 : 210\*145MM  
80克书纸  
黑白印刷



MODEL NO. **RPJ143-50DISP**

## MULTIMEDIA PROJECTOR INSTRUCTION MANUAL



Ideal for dark viewing environments for optimal performance.  
Please note: Projector brightness is measure in ANSI lumens. Your viewing environment is the deciding factor on how many lumens your projector needs.

### PLEASE READ BEFORE OPERATING THIS EQUIPMENT

This product is manufactured and sold by SHENZHEN KEJINMING ELECTRONIC CO.,LTD. RCA, the RCA logo, the two dogs (Nipper and Chipper) logo, are registered trademarks or trademarks of RCA Trademark Management and are used under license by SHENZHEN KEJINMING ELECTRONIC CO.,LTD. Any other product, service, company, trade or product name and logo referenced herein are neither endorsed nor sponsored by RCA Trademark Management or its affiliates.

## **Important Safety Instructions**

1. Read these Instructions.
2. Keep these Instructions.
3. Heed all Warnings.
4. Follow all instructions.
5. Do not use this apparatus near water.
6. Clean only with a dry cloth.
7. Do not block any ventilation openings. Install in accordance with the manufacturer's instructions.
8. Do not install near any heat sources such as radiators, heat registers, stoves, or other apparatus (including amplifier) that product heat.
9. Protect the power cord from being walked on or pinched particularly at plugs, convenience receptacles, and the point where they exit from the apparatus.
10. Only use attachments/accessories specified by the manufacturer.
11. Unplug this apparatus during lightning storms or when unused for long periods of time.
12. Refer all servicing to qualified service personnel. Servicing is required when the apparatus has been damaged in any way, such as power-supply cord or plug is damaged, liquid has been spilled or objects have fallen into the apparatus, the apparatus has been exposed to rain or moisture, does not operate normally, or has been dropped.
13. Use only with a cart, stand, tripod, bracket, or table specified by the manufacturer or sold with the apparatus. When a cart is used, use caution when moving the cart/ apparatus combination to avoid injury from tip-over.



## **Additional Warnings and Precautions**

1. Do not look directly into the projector light.
2. **Don't touch the project lens**
3. Mains adapter is used as disconnect device and it should remain readily operable during intended use. In order to disconnect the apparatus from the mains completely, the mains plug should be disconnected from the mains socket outlet completely.
4. **CAUTION:** Use of controls or adjustments or performance of procedures other than those specified may result in hazardous radiation exposure.
5. **WARNING:** Changes or modified to this unit not expressly approved by the party responsible for compliance could void the user's authority to operate the equipment.
6. **WARNING:** Use of this unit near fluorescent lighting may cause interference regarding use of the remote. If the unit is displaying erratic behavior move away from any fluorescent lighting, as it may be the cause.
7. **WARNING:** Shock hazard - Do Not Open.
8. Caution and marking information is located at the rear or bottom of the apparatus.
9. **WARNING:** To reduce the risk of fire or electric shock, do not expose this apparatus to rain, moisture, dripping, or splashing.
10. Objects filled with liquids, such as vases, shall not be placed on the apparatus.

## **FCC Warning**

This device complies with Part 15 of the FCC rules. Operation is subject to the following two conditions: (1) this device may not cause harmful interference, and (2) this device must accept any interference received, including interference that may cause undesired operation.

**NOTE:** This equipment has been tested and found to comply with the limits for a Class B digital device, pursuant to Part 15 of the FCC Rules. These limits are designed to provide reasonable protection against harmful interference in a residential installation. This equipment generates, uses, and can radiate radio frequency energy and, if not installed and used in accordance with the instructions, may cause harmful interference to radio communications. However, there is no guarantee that interference will not occur in a particular installation. If this equipment does cause harmful interference to radio or television reception, which can be determined by turning the equipment off and on, the user is encouraged to try to correct the interference by one or more of the following measures:

- Reorient or relocate the receiving antenna.
- Increase the separation between the equipment and receiver.
- Connect the equipment into an outlet on a circuit different from that to which the receiver is connected.
- Consult the dealer or an experienced radio/TV technician for help.

**Warning:** Changes or modifications to this unit not expressly approved by the party responsible for compliance could void the user's authority to operate the equipment.

## **In The Box**

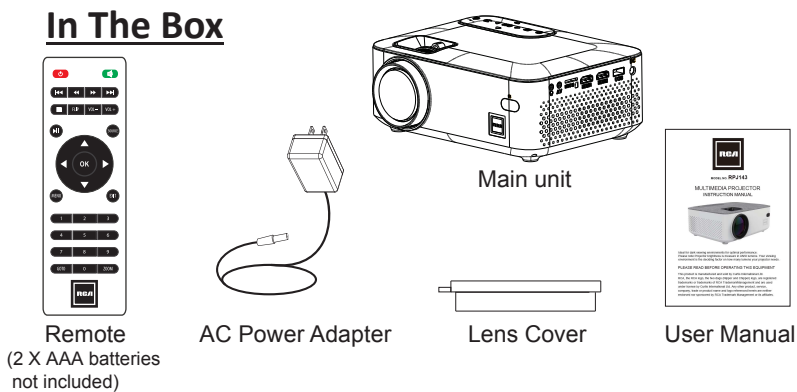

## **Table of Contents**

<b>Important Safety Instructions</b> .....	<b>P1</b>
<b>Additional Warnings and Precautions</b> .....	<b>P2</b>
<b>FCC Warning</b> .....	<b>P3</b>
<b>In The Box</b> .....	<b>P3</b>
<b>Table of Contents</b> .....	<b>P4</b>
<b>Remove &amp; Close the Lens Cover</b> .....	<b>P5</b>
<b>Placing Your Projector</b> .....	<b>P5</b>
<b>To Reduce Image Distortion</b> .....	<b>P6</b>
<b>Distance Between The Projector And Screen</b> .....	<b>P6</b>
<b>Placing Your Projector On Ceiling</b> .....	<b>P6</b>
<b>Adjust the Vertical Location</b> .....	<b>P7</b>
<b>Adjust the Focus and Keystone</b> .....	<b>P7</b>
<b>Controls of Remote</b> .....	<b>P8</b>
<b>Install / Remove Battery Of Remote</b> .....	<b>P8</b>
<b>Controls of Projector</b> .....	<b>P9</b>
<b>Install Power Adapter</b> .....	<b>P10</b>
<b>Connect HDMI show the Image On Projector Screen</b> .....	<b>P11</b>
<b>Connect AV Show The Image On Projector Screen</b> .....	<b>P11</b>
<b>Connect VGA Show The Image On Projector Screen</b> .....	<b>P12</b>
<b>Connect Audio Output (Aux Out / Line Out / Earphones)</b> .....	<b>P13</b>
<b>Install USB Device And MicroSD Card</b> .....	<b>P13</b>
<b>Using microSD Card and USB Playback</b> .....	<b>P14</b>
<b>Using Bluetooth playback</b> .....	<b>P15</b>
<b>Using Projector Menu 1.0</b> .....	<b>P16</b>
<b>Using Projector Menu 2.0</b> .....	<b>P17</b>
<b>Using Projector Menu 3.0</b> .....	<b>P18</b>
<b>Using Projector Menu 4.0</b> .....	<b>P19</b>
<b>Specifications</b> .....	<b>P20</b>
<b>Troubleshooting</b> .....	<b>P21</b>

## Remove & Close The Lens Cover

Remove the lens cover before using

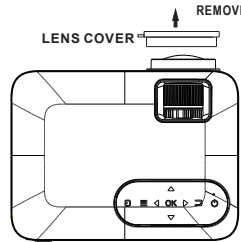

Close the lens cover when unit not using

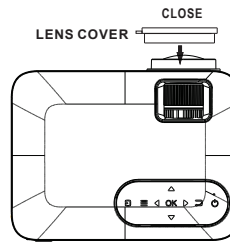

## Placing Your Projector

Your projector can be installed in four different configurations ( see picture below):

Front Table:

Select this location with the projector placed near the floor in front of the screen. This is the most common way to position the projector for quick setup and portability.

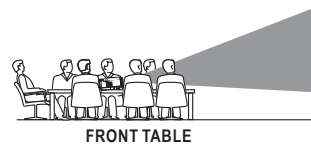

Front Ceiling:

Select this location with the projector suspended upside-down from the ceiling in front of the screen.

**NOTE:** A projector mount is required to install the projector in a ceiling.

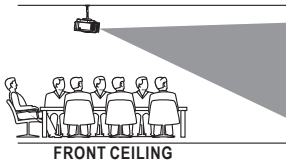

Rear Table:

Select this location with the projector placed near the floor behind the screen.

**NOTE:** That a special rear projection screen is required.



Rear Ceiling:

Select this location with the projector suspended upside-down from the ceiling behind the screen.

**NOTE:**

A projector mount is required to install the projector in a ceiling.

A special rear projection screen is required.

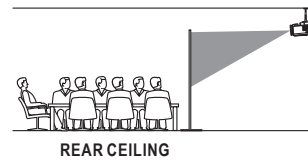

## To Reduce Image Distortion

Square /Rectangle

It is recommended to move the projector as close to center of screen.

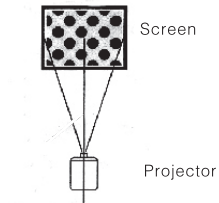

## Distance Between The Projector And Screen

Measure the distance between the projector and where you want to position the screen. This is the projection distance.

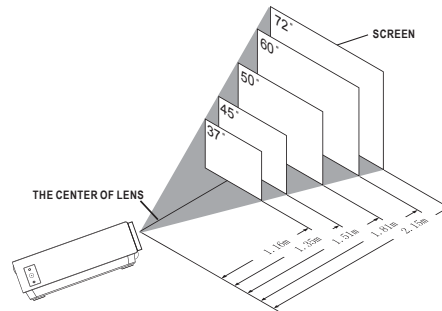

## Placing Your Projector On Ceiling

When installing the projector in the ceiling, please purchase a projector mount recommended by an installation professional and follow the instructions that come with the mount.

Before installing the projector in the ceiling, please check to make sure the ceiling structure can support the weight of the projector and the mount. If in doubt, please ask the advice from an installation professional.

**NOTE:** Projector mount and screw(s) not included

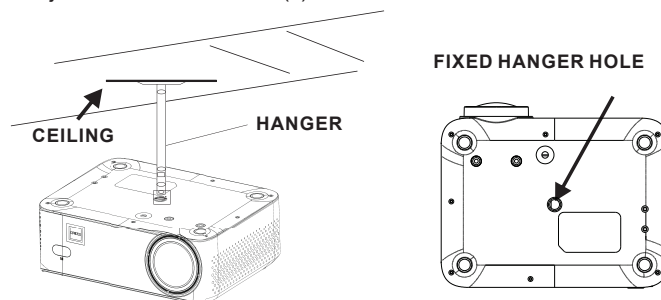



## Adjust The Vertical Location

Follow below picture to adjust the vertical location.

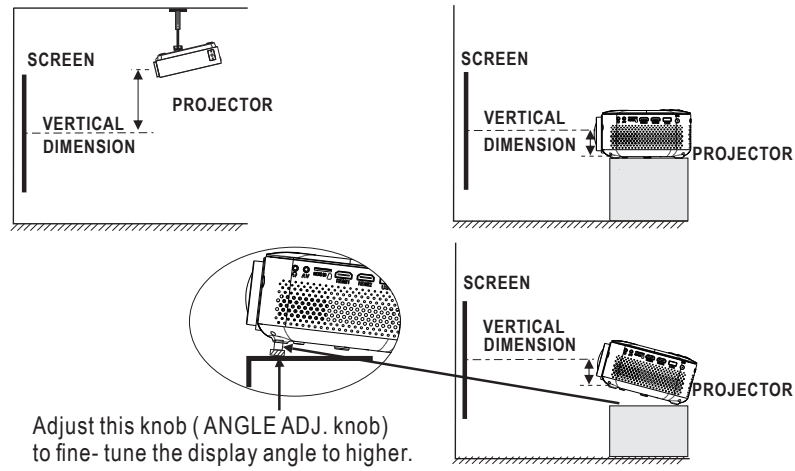

## Adjust The Focus And Keystone

Follow below picture to adjust the focus and trapezoidal screen.

Adjust the focus by turning the knob while observing the image pixels near the center of the screen. Optimal focus is obtained when the pixels are clearly visible. Depending on the projected screen size, the focus near the screen edges may be less sharp than the screen center.

### FOCUS ADJ. KNOB

Then sharpen the image by rotating focus knob.

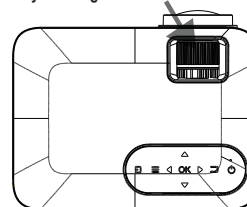

### TRAPEZOIDAL ADJ. KNOB

Keystone image is created when the projector beam is projected to the screen in an angle. Keystone correction will restore the distorted image to a rectangular or square shape.

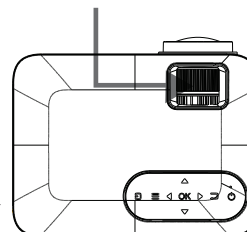

## Controls Of Remote

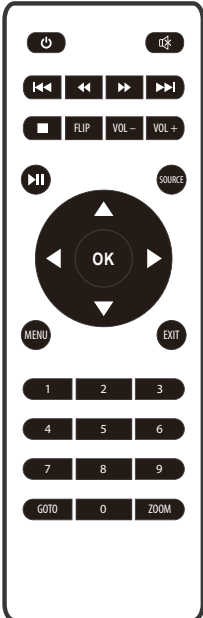
<p><b>Power</b> Press to power ON. Press twice to power OFF.</p> <p><b>◀◀ Previous / Next ▶▶</b> Press to skip between chapters or tracks.</p> <p><b>■ Stop</b> Press to stop playback.</p> <p><b>Flip</b> Press to flip display image 180°.</p> <p><b>▶   Play/Pause</b> Press to play or pause an individual chapter or track.</p> <p><b>Arrows/OK</b> Press to navigate and confirm selections in Settings and other menus.</p> <p><b>Menu</b> Press to access projector Settings.</p> <p><b>Go To/Number Keypad</b> Press to enter specific chapter or track numbers. Use Play button to begin playing.</p>		<p><b>Mute</b> Press to mute volume.</p> <p><b>◀◀ Back / Fwd ▶▶</b> Press to search through an individual chapter or track.</p> <p><b>VOL+ / VOL-</b> Press to adjust audio level.</p> <p><b>Source</b> Press to select media source (AV, PC, HDMI, MEDIA).</p> <p><b>Exit</b> Press to exit menus.</p> <p><b>Zoom</b> Press to zoom display image in or out.</p>
---	--	---

## Install / Remove Battery Of Remote

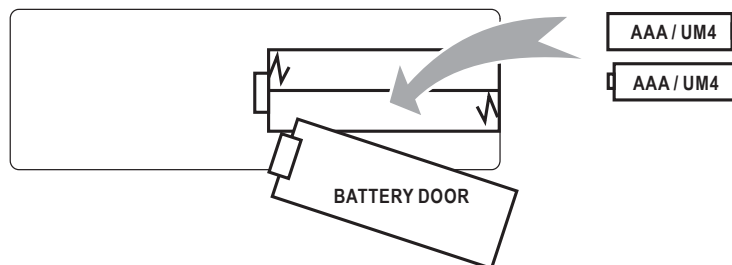

Remove the battery compartment cover on the back of your remote by carefully sliding to open. The battery cover can then be lifted away. Fit the correct batteries (2 X AAA batteries not included), referring to the polarity markings. Finally, replace the cover.

### **NOTES:**

- Batteries shall not be exposed to excessive heat such as sunshine, fire
- Be sure that the batteries are installed polarity correctly.
- Only same or equivalent type batteries as recommend are to be used.
- Do not dispose of batteries in fire, battery may explode or leak. Do not try to recharge a battery
- Do not mix old and new batteries.
- Do not mix alkaline, standard (carbon-zinc), or rechargeable (ni-cad, ni-mh, etc) batteries

## Controls Of Projector

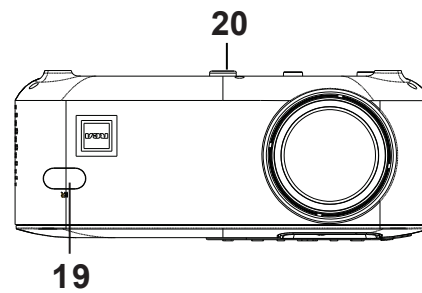
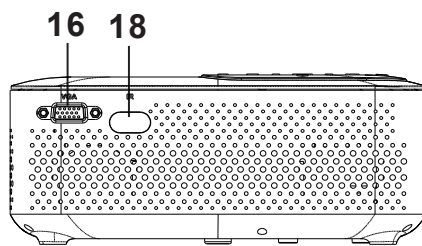
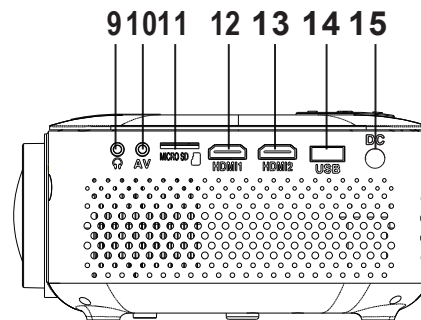
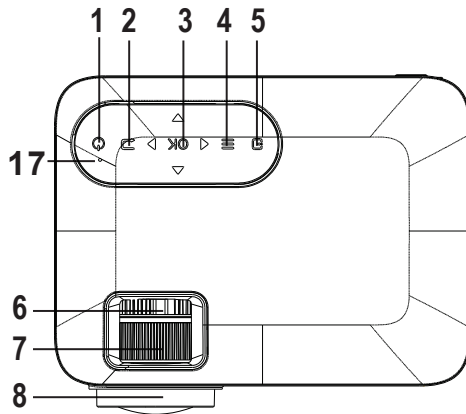

1. POWER  Button	11. Micro SD Card
2. RETURN  Button	12. HDMI Port 1
3. NAVIGATION  Button	13. HDMI Port 2
4. MENU  Button	14. USB Port
5. SOURCE  Button	15. DC IN jack
6. TRAPEZOIDAL ADJ. Knob	16. VGA Port
7. FOCUS ADJ. Knob	17. POWER on Indicator
8. LENS	18. IR Window ( Rear Side)
9. EAR PHONE Jack	19. IR Window ( Front Side)
10. AV IN Jack	20. ANGEL ADJ. Knob

## Controls

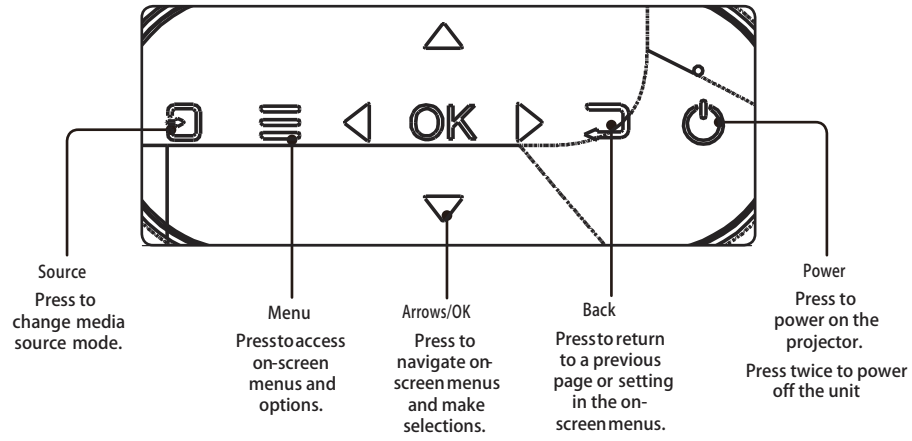

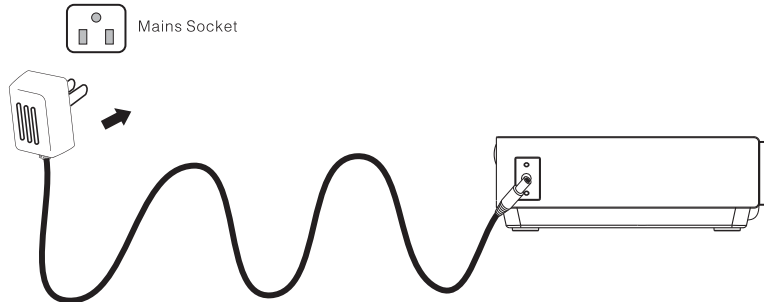

## Install Power Adapter

Follow below picture to connect power adapter  
Connect small end of adapter **FIRST**. Plug the adapter body to power outlet.



## Connect HDMI Show The Image On Projector Screen

Follow below picture to connect HDMI cable and device.

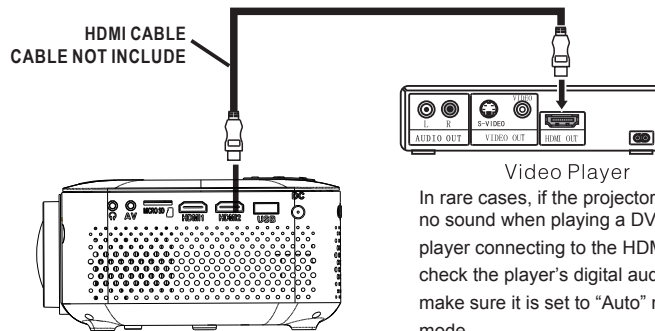

1. Turn off the unit before connect HDMI cable.
2. After connect, press the  button to turn on unit and power indicator will light GREEN
3. Press the  / **SOURCE** button to HDMI mode and the video of HDMI device will show on projector screen. There are 2 HDMI input, HDMI1 interface corresponds to HDMI 1 in SOURCE mode , and HDMI2 interface corresponds to HDMI 2 in SOURCE mode.
4. Press the  button twice to turn off unit power.

**HDMI hd signal input : this interface can be input with HD player**  
**HDMI output at the connection.**



## Connect AV Show The Image On Projector Screen



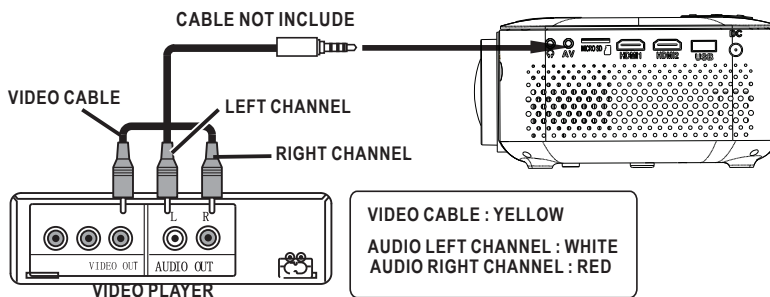

Follow below picture to connect AV cable and device.

1. Turn off the unit before connect AV cable.
2. Use AV cable to connect follow below figure
3. After connect, press the  button to turn on unit and power indicator will light GREEN
4. Press the  / **SOURCE** button to AV mode and the video of AV device will show on projector screen
5. Press the  button twice to turn off unit power.



## Connect VGA Show The Image On Projector Screen

Follow below picture to connect VGA cable and device.

1. Turn off the unit before connect VGA cable.
2. Press the  button twice to turn off power of your projector before connection.
3. After connect, press the  button to turn on unit and power indicator will light GREEN
4. Press the  / **SOURCE** button to VGA mode and the video of VGA device will show on projector screen.
5. Press the  button twice to turn off unit power.

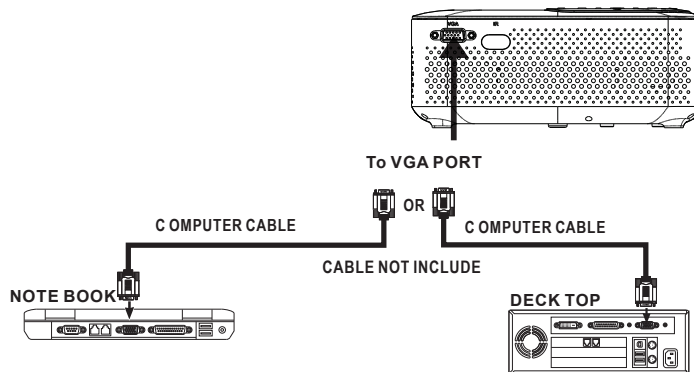

Please refer to the following table to adjust the output signal from computer

Type	Resolution		Frequency	Field Frequency
PC	VGA	640x480	31.5	60
			34.7	70
			37.9	72
			37.5	75
	SVGA	800x600	31.4	50
			35.1	56
			37.9	60
			46.6	70
			48.1	72
	XGA	1024x768	46.9	75
			40.3	50
			48.4	60
56.5			70	

## **Connect Audio Output ( Aux Out / Line Out / Earphones)**

Follow below picture to connect audio cable and device.

1. Press the  button twice to turn off power of your projector before connection.
2. Use audio cable to connect follow below figure.
3. After connect and turn on both units. Your projector sound from external device now.
4. After using , turn off both unit

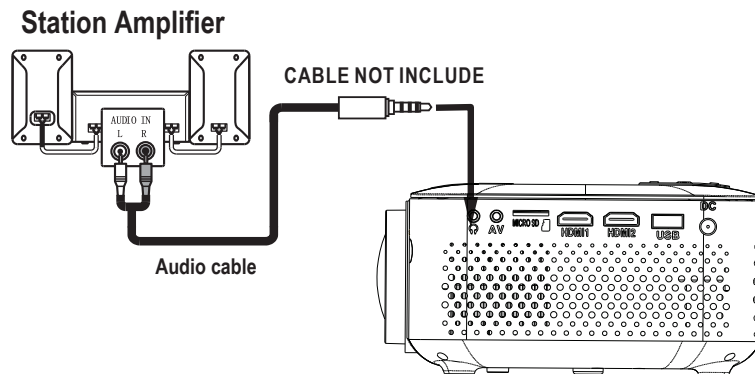

## **Install USB Device And Micro SD Card**





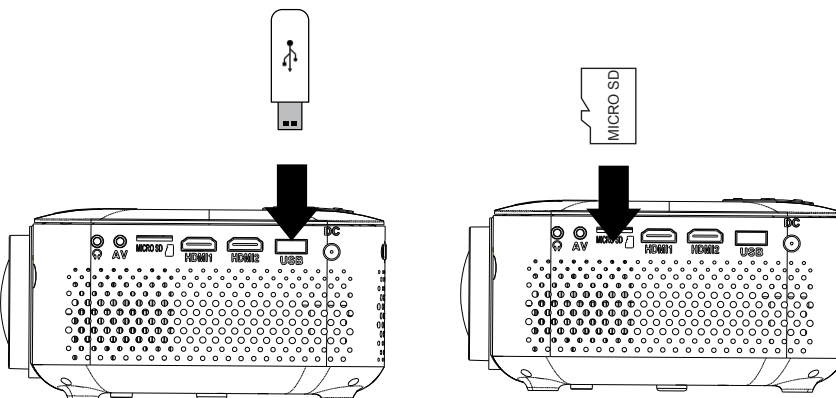









Follow below picture to install USB and microSD Card.

Turn off the unit before install USB / microSD Card.













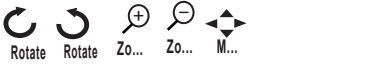

## Using microSD Card And USB Playback (Media Player)

Install USB / microSD device:

1. Turn off the unit before install USB / microSD Card.
2. Install the USB device into USB port.
3. After connect, press the  button to turn on unit and the power indicator light GREEN.
4. Press the  / **SOURCE** button to enter and use  buttons to search the MEDIAPLAYER mode.
5. After selection, use  buttons to search the MUSIC / PHOTO / MOVIE icon and press the  button to enter. If necessary, use the  button to select microSD card or USB and press the  button to enter.
6. Use  buttons to search the correct file and press the  button to preview playback file and press the  button of unit or  button of remote to start playback.
7. Press  button to fast search forward and rewind.
8. Press  button to search next or previous file.
9. During playback, press the  button to pause and press again to resume.

**NOTE:** Remove USB / microSD device, press the  button twice to turn power **FIRST**.

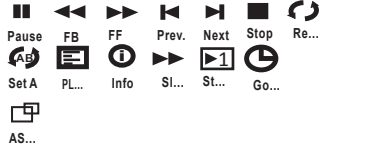
Sub-Menu on Photo screen	
<ol style="list-style-type: none"> <li>1. When photo playback, press the  button and more function screen show on lower (figure 1).</li> <li>2. Use the  button to select icon and press the  button to play special function.</li> </ol>	<p style="text-align: center;">Figure 1.</p>  
Sub-Menu on Music screen	
<ol style="list-style-type: none"> <li>3. When music playback, press the  button and more function screen show on lower (figure 2).</li> <li>4. Use the  button to select icon and press the  button to play special function.</li> </ol>	<p style="text-align: center;">Figure 2</p> 
Sub-Menu on Movie screen	
<ol style="list-style-type: none"> <li>5. When movie playback, press the  button and more function screen show on lower (figure 3).</li> <li>6. Use the  button to select icon and press the  button to play special function.</li> </ol>	<p style="text-align: center;">Figure 3</p> 



## Using Bluetooth Playback

### Pairing to Bluetooth Wireless Speakers or Sound Bar

**NOTE: Bluetooth is OFF by default when the projector powers ON. Bluetooth can be turned ON or OFF from the OPTIONS Menu.**

1. Enable Bluetooth on the receiver (external speakers, sound bar, etc.) to which you wish to connect. Devices such as smartphones, tablets, or computers are not Bluetooth receivers and will not connect to the projector. To eliminate confusion, you should disable Bluetooth on all receivers to which you do not wish to connect.  
The bluetooth pairing list is not acceptable, it needs show what is the step to turn on the projector and show the picture on the manual.
2. Power on the projector and make sure the projector's Bluetooth is on and in pairing mode (see note above). Press the menu key from the remote>>>select OPTION>>>select BlueTooth>>>press the navigation >/< to turn on the bluetooth>>>Select the bluetooth on, press the OK key from the remote, when the Scan shows on the screen, press the OK key again>>>When the screen shows 'Searching, pl...' >>>the bluetooth devices name will be shown on the screen, select it and press the OK key to connect it.



3. When successfully paired, it will show ' Bluetooth Connected' on the menu. Exit the menu, the sound will come out from the bluetooth speaker.
4. It can connect last bluetooth speaker automatically when the unit is powered on again.  
Note: It needs power on the last connected bluetooth speaker first, then turned on the projector. if it can't connect last devices automatically, please repeat step 2~3.

After initial pairing, the projector and the Bluetooth speakers will stay paired unless unpaired manually by the user, or erased due to a reset of either device. If this occurs, or you find either unit is unable to connect, repeat the above steps.

## Using Projector Menu 1.0

Press  button to enter projector menu. Press again to previous status.

Picture Mode	Standard
Contrast	50
Brithness	50
Color	50
Sharpness	50
Color Temperature	Medium
Aspect Ratio	Auto
Noise Reduction	Middle
Screen	

Use  buttons to select manual page.  
This manual showed on right upper of view screen.

- 1. Picture Mode**  
Select Vivid, User (custom), Soft ,or Standard
- 2. Contrast ,Brightness, etc**  
Set Picture Mode to "User " to adjust these settings
- 3. Color Temperature**  
Select Warm ,Cool, or Medium.
- 4. Aspect Ratio**  
Select 16:9, 4:3 , or Auto
- 5. Noise Reduction**  
Select Off, Low , Middle , High or Default
- 6. Screen**

Color temper... (temperature)	
Customer define	Parameter
red	0-100
blue	0-100
green	0-100

Aspect Ratio	
4:3	The signal in a 4:3 aspect ratio projection image
16:9	The signal in a 16:9 aspect ratio projection image

## Using Projector Menu 2.0

Press  button to enter projector menu. Press again to previous status.

<b>Sound Mode</b>	<b>Standard</b>
<b>Treble</b>	<b>50</b>
<b>Bass</b>	<b>50</b>
<b>Balance</b>	<b>0</b>
<b>Auto Volume</b>	<b>Off</b>
<b>Surround Sound</b>	<b>Off</b>

Use  buttons to select manual page.

This manual showed on right upper of view screen.

1. **Sound Mode**  
Select Music, Movie, User (custom), Sports ,or Standard
2. **Treble, Bass**  
Set Sound Mode to "User " to adjust these settings
3. **Balance**  
Adjust the audio balance.
4. **Surround Sound**  
Turn Surround Sound ON or OFF.

Sound Mode - User	Parameter
Treble	0-100
Bass	0-100

## Using Projector Menu 3.0

Press  button to enter projector menu. Press again to previous status.

OSD Language	English
Bluetooth	
Restore Factory Default	
Panel Rotate	0
Info	

Use  buttons to select manual page. This manual showed on right upper of viewing screen.

1. **OSD Language**  
Select different language, Follow below figure.
2. **Bluetooth**  
Turn Bluetooth ON or OFF
3. **Restore Factory Default**  
Select Y or N.
4. **Panel Rotate**  
Select rotate 0, rotate 1, rotate 2, rotate 3..
5. **INFO**  
Display the unit information as below.

Model KJM-222
SN:RPJ143
RCA
SW Ver: V1.0
LOGO: RCA
FL18891_T2M

English	Hrvatski	Nederlands	Chinese
Franais	Deutech	Slovenina	Slovak
Espanol	Italiano	Norsk	
Portugues	Magyar	Srpski	
Esky	Polski	Svenska	
Dansk	Romnete	Suomi	

## Using Projector Menu 4.0

Press  button to enter projector menu. Press again to previous status.

<p>Clock - - - Off Timer Off On Timer Off Sleep Timer Off Auto Sleep Never</p>
--

Use  buttons to select manual page.  
This manual showed on right upper of viewing screen.

- 1. Clock-- --**  
Select clock to Day, Month, Year, Hour ,and Minutes.
- 2. Off Timer**  
Select turn off timer to Day, Hour ,and Minutes.
- 3. On Timer**  
Select turn on timer to Day, Hour ,and Minutes.
- 4. Sleep Timer**  
Select sleep timer to Off, 10min, 20min, 30 min, 60min, 90min, 120min, 180min, 240min
- 5. Auto Sleep**  
Select auto sleep function to Never, 4 hour, 6 hour, 8 hour.

## **Specifications**

Light Source Type	LED
Brightness Output	White light output ANSI: 50.7 Lumens Color Light output ANSI: 46 Lumens White brightness output ANSI: 30.8 Lumens
Display Native Resolution	800 x 480
HDMI Input Supported Video Resolution.	1080p , 1080i , 720p, 576i , 480p, and 480i
Power Consumption	Operating 36W; Standby 1W
Power Input Connect Included Adapter	DC 12V , 3.5A
Included Adapter Connect DC input of unit	Input AC100-240V,50/60Hz Output DC12V , 3.5 A
Display Color	7000-8000K
Projection Size	30-100 inch
Signal Port	Video / VGA / HDMI
USB Port	Support USB device up to 32GB Support format mpeg1, Mpeg2 ,mpeg4, mp3 , Jpeg
SD Card	Support SD card up to 32GB Support format mpeg1, Mpeg2 ,mpeg4, mp3 , Jpeg
Weight	0.9 KG
Dimension	203 x 150 x 82 mm

Ideal for dark viewing environments for optimal performance.  
Please note:Projector brightness is measure in ANSI lumens. Your viewing environment is the deciding factor on how many lumens your projector needs.

## **TROUBLESHOOTING**

Before resorting the maintenance service, please kindly check by yourself with the following chart.

No Image is Projected or a "No Signal" message is displayed	<ol style="list-style-type: none"> <li>1.Is the power hight on? If it is not on, check the projector is plugged into the mains, that the socket is switched on, and then press the power button on the projector.</li> <li>2.Check the lens cover has been removed.</li> <li>3.Check the cables are securely attached and installed as per the User Manual.</li> <li>4.The image source may not be set correctly. Press the Source button on the Control Panel or the Remote, to select the correct setting.</li> <li>5.Check in the Menu section under Video input signal to make sure that has been set correctly.</li> </ol>
The Lamp (Bulb) switches off after a period of time	<ol style="list-style-type: none"> <li>1.Leave the projector to cool for a few moments.</li> <li>2.Once cooled, check if anything is blocking the ventilation vents.</li> <li>3.Turn on the projector.</li> </ol> <p>If the issue persists please contact your support provider for further assistance.</p>
The Image is wider at the top/bottom of the screen	<p>This is called keystone and is due to the projection angle not being perpendicular to the screen. To correct use the projectors inbuilt keystone function to adjust the image.</p>
Spots on the screen	<p>Using a vacuum cleaner to clean the lens. If cleaning doesn't resolve things, please contact your support provider for further assistance.</p>
The image brightness has faded	<p>This could possible be caused by the ambient light in the room. If not ,the chances are that you need to replace the lamp (bulb).</p>

For service assistance and product information, please call: **1-800-968-9853**.

Pour obtenir assistance et information appelez: **1-800-968-9853**.

SHENZHEN KEJINMING ELECTRONIC CO.,LTD

7045 BECKETT DRIVE, UNIT 15,

MISSISSAUGA, ON, L5S 2A3 [www.curtisint.com](http://www.curtisint.com)

To make a warranty claim, do not return this product to the store. Please email [support@curtiscs.com](mailto:support@curtiscs.com) or call 1-800-968-9853.

### **90 day Year Warranty**

This product is warranted to be free from defects in material and workmanship for a period of ninety (90) days from the date of original purchase. During this period, your exclusive remedy is repair or replacement of this product or component found to be defective, at our option; however, you are responsible for all costs associated with returning the product to us. If the product or component is no longer available, we will replace with a similar one of equal or greater value. Prior to a replacement being sent, the product must be rendered inoperable or returned to us.

This warranty does **not** cover glass, filters, wear from normal use, use not in conformity with the printed directions, or damage to the product resulting from accident, alteration, abuse, or misuse. This warranty extends only to the original consumer purchaser or gift recipient. Keep the original sales receipt, as proof of purchase is required to make a warranty claim. This warranty is void if the product is used for other than single-family household use or subjected to any voltage and waveform other than as on the specified rating on the label (e.g., 120V~60Hz).

We exclude all claims for special, incidental, and consequential damages caused by breach of express or implied warranty. All liability is limited to the amount of the purchase price. **Every implied warranty, including any statutory warranty or condition of merchantability or fitness for a particular purpose, is disclaimed except to the extent prohibited by law, in which case such warranty or condition is limited to the duration of this written warranty.** This warranty gives you specific legal rights. You may have other legal rights that vary depending on where you live. Some states or provinces do not allow limitations on implied warranties or special, incidental, or consequential damages, so the foregoing limitations may not apply to you.

For faster service, locate the model, type, and serial numbers on your appliance.